

Alkitab keu aneuek-aneuek
Jipeuseumah lé

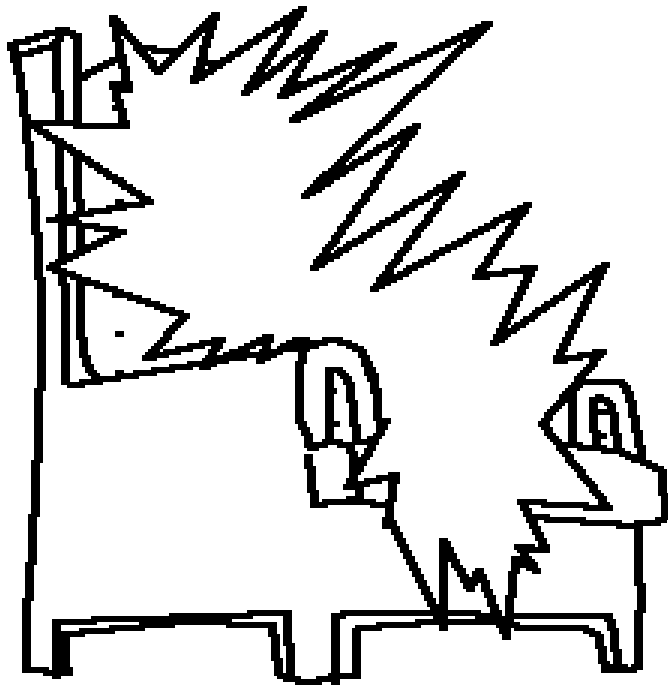

Syuruga,
Rumoeh
Allah nyang
lagak



Jitoeléh lé: Edward Hughes
Jiconto lé: Lazarus
Jipeujelah lé: Sarah S.
Ji-aréetikan lé: Ernawati
Jipeugèt lé: Bible for Children
www.M1914.org

BFC
PO Box 3
Winnipeg, MB R3C 2G1
Canada

©2011 Bible for Children, Inc.

Lisensi: Droen jeuet copy atawa ceutak calitra nyoe,
asei droen hana geupubloe.



Watée Isa udéb ji donya, Gobnyan geukheuen bak murit-murit Gobnyan bhaih syuruga. Gobnyan peugah: Rumoeh Bapak, dan geukheuen di syideh léé rumoeh-rumoeh nyang rayeuek.

Saboeh rumoeh nyang luah, rumoeh nyang lagak. Syuruga nakheuh rumoeh nyang luah dan lagak that nibak



teumpang pat manthong di donya.



Isa geukheuen, "Ulôn jak keu peusiap teumpat bagi gata, dan meunyoe Loen jak dan peusiap teumpat bagi gata, Loen teuma troôk lom dan teurimoung gata keujeuet ata Loen".



Isa jak u syuruga, oh lheueh Gobnyan bangkét nibak matéé. Seumeutara awak murit geupandang Isa teubeuôt u syuruga, dan awan geututoep nibak pandangan awaknyan.

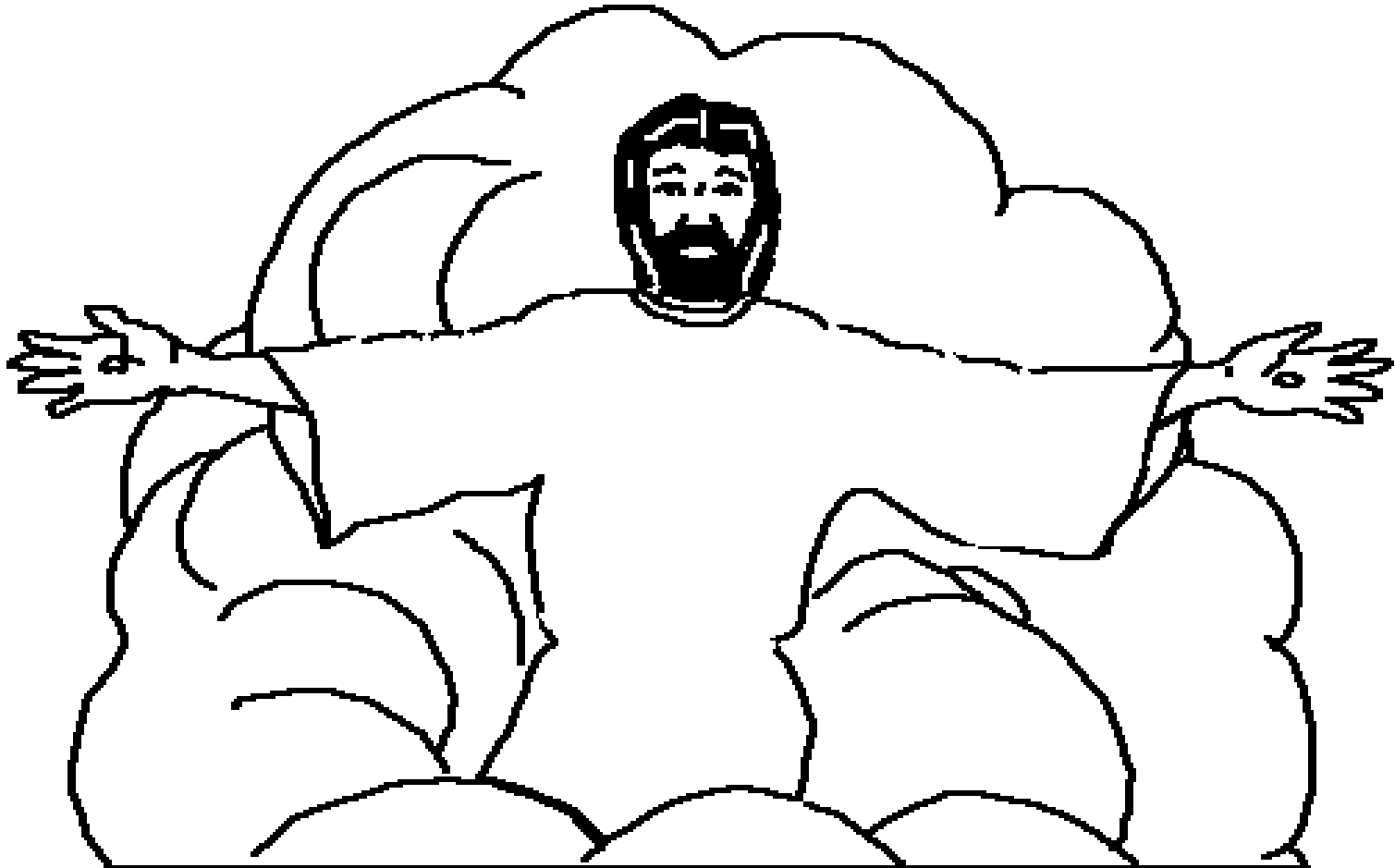

Oh lheueh watée nyan, ureueng-ureueng Kristen
sabée geuingat teuma janji-janji Isa keu trôk
geutûng awaknyan. Isa geukheuen Gobnyan
teuma trôk deungoen seukeujab.

Tapi pakriban deungoen
ureueng-ureueng peucaya
(Kristen) nyang matéé
leubeh awai seugolom
trôk-Gobnyan?

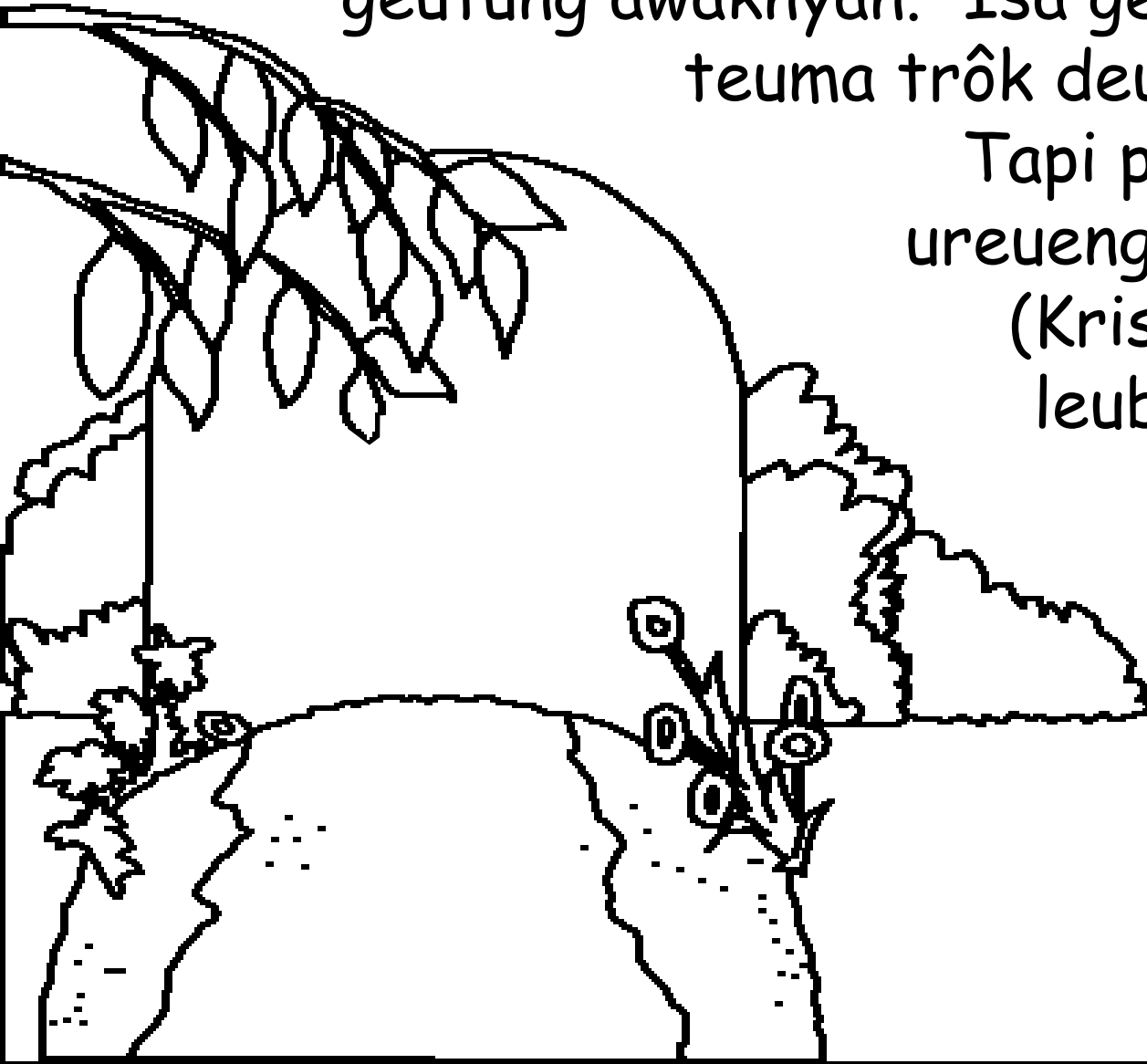

Alkitab geucatat bahwa
awaknyan teuma langsoeng
jak meusajan-sajan deungoen
Isa. Tuboeh awai teuma
gadôh jigantho deungoen
hadirat Allah.

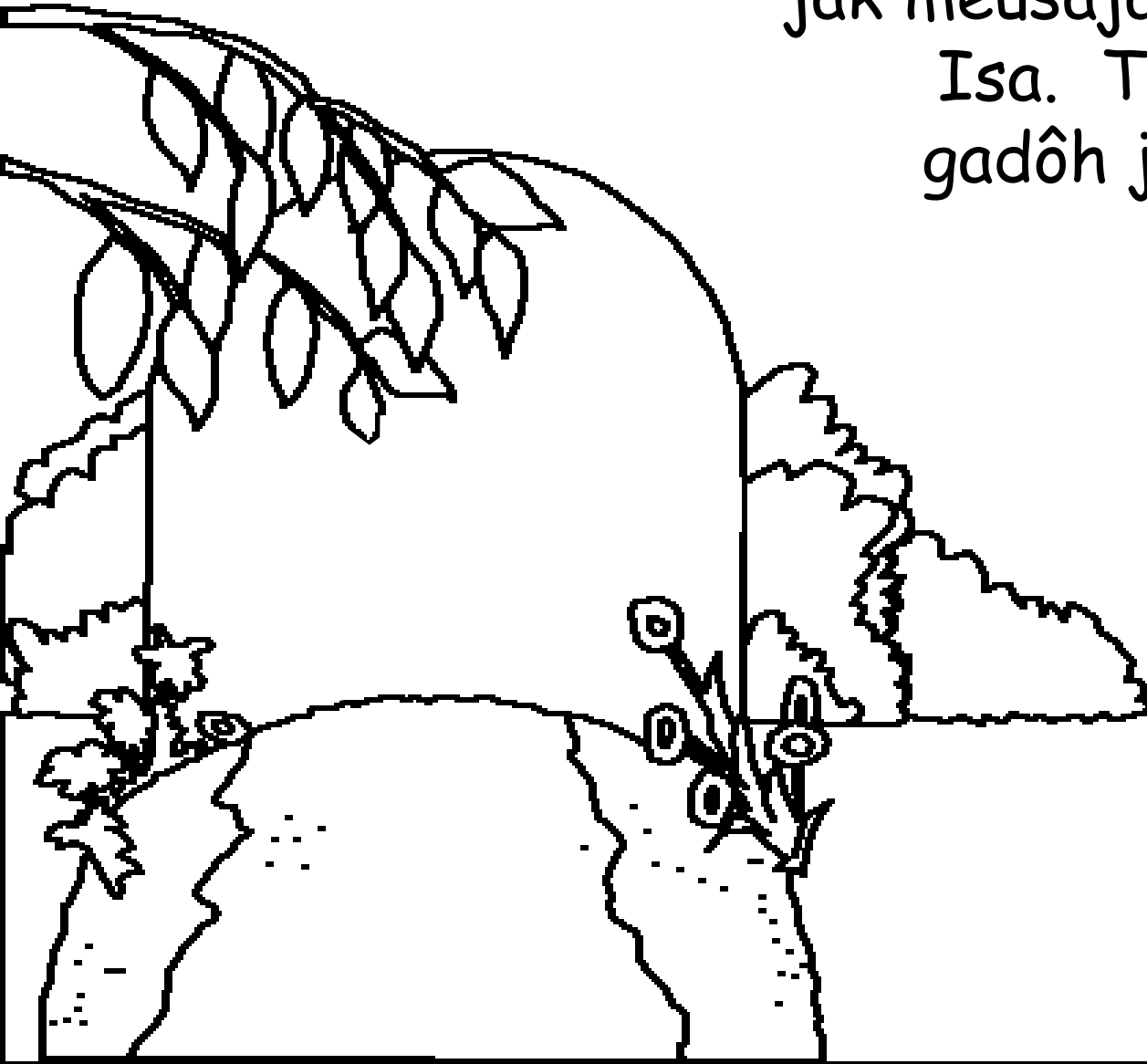

Wahyu na kheueh bagian akhe nibak Alkitab nyoe,
geucalitra bak geutanyoe bhaih syuruga nyang
lagak. Saboeh hai nyang lagak that,
dalam cara nyang khusus, syuruga
nakheueh teumpat rumoeh

Allah. Allah na di
pat manthong
tapi tahta
Gobnyan
na di lam
syuruga.

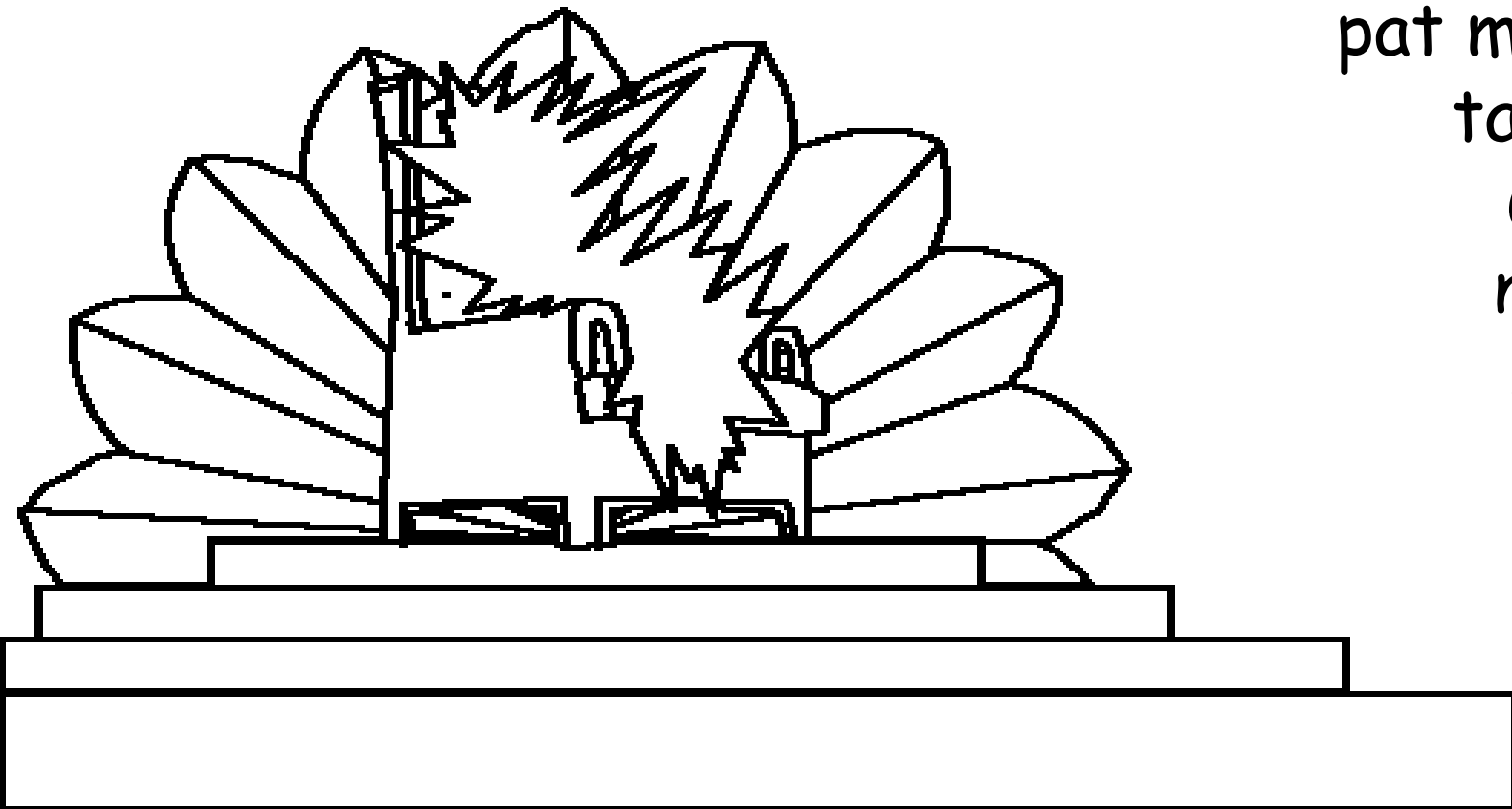

Awak malaikat dan banmandum makhluk di syuruga
geuseumah Allah. Banmandum umat Allah nyang
ka matéé teuma jak u syuruga.

Awaknyan geunyanyie lagu-lagu
pujoe nyang khusus bak Allah.

Nyoe nakheueh padub bôh

baet nibak

salah saboeh

pujoe nyang

awaknyan

nyanyie.

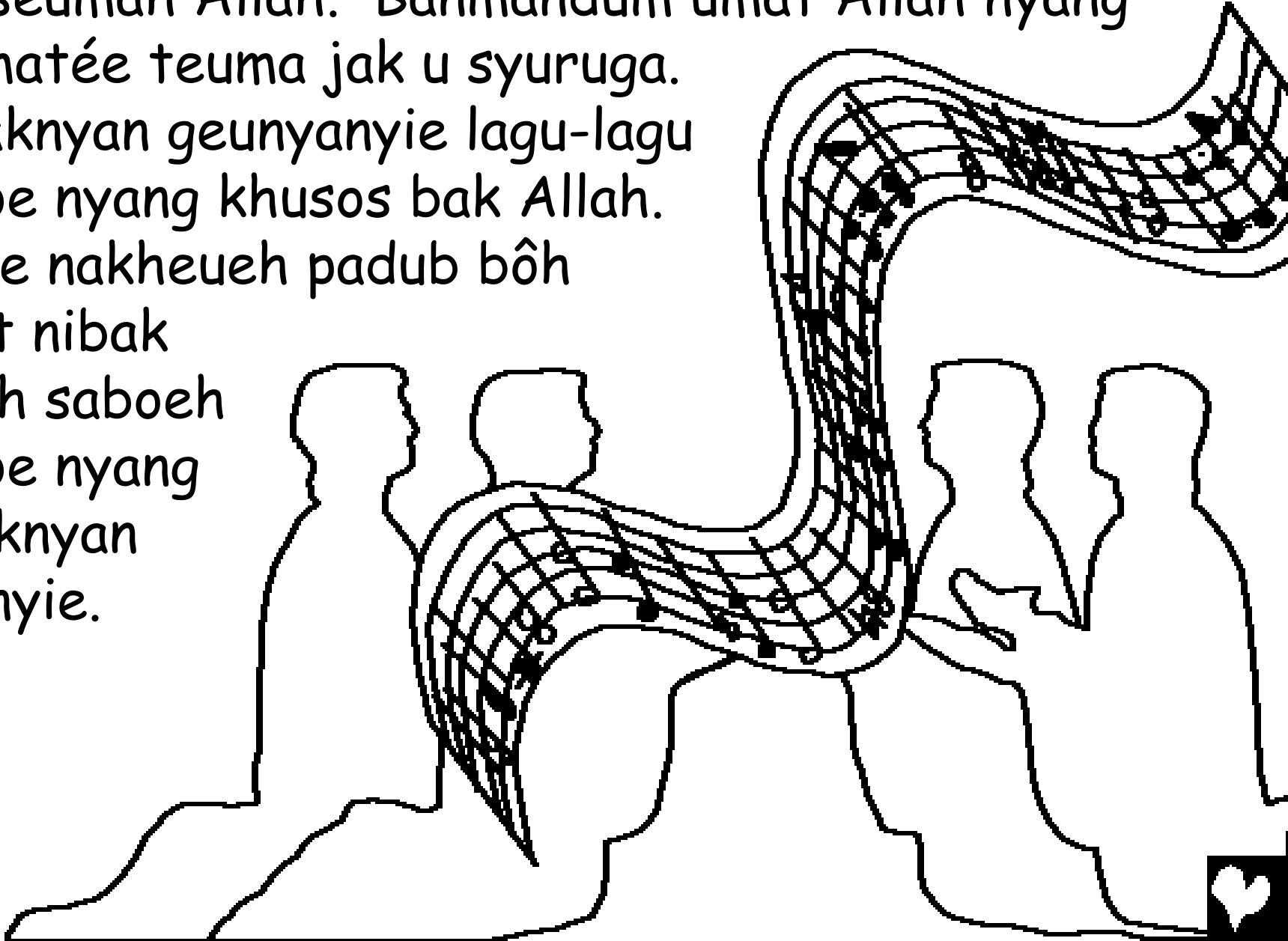

DROEN LAYAK GEUTEUBOH KAMOE DEUNGOEN
DARAH-DROEN NYANG TEUROE
BAGI TIÈP-TIÈP SUKU-SUKU
BANGSA DAN GEUPEUJEUET
KAMOE RAJA-RAJA DAN
IMEUM-IMEUM BAGI ALLAH
GEUTANYOE.

(Wahyu 5:9)



Bagian akhe nibak Alkitab digamba syuruga seubagoe Yerusalem baroe. Nyoe keubit rayeuek, deungoen binteueh di lua nyang manyang. Binteueh nyoe di peuget nibak batée-batée beuwarna crah lagée kristal.

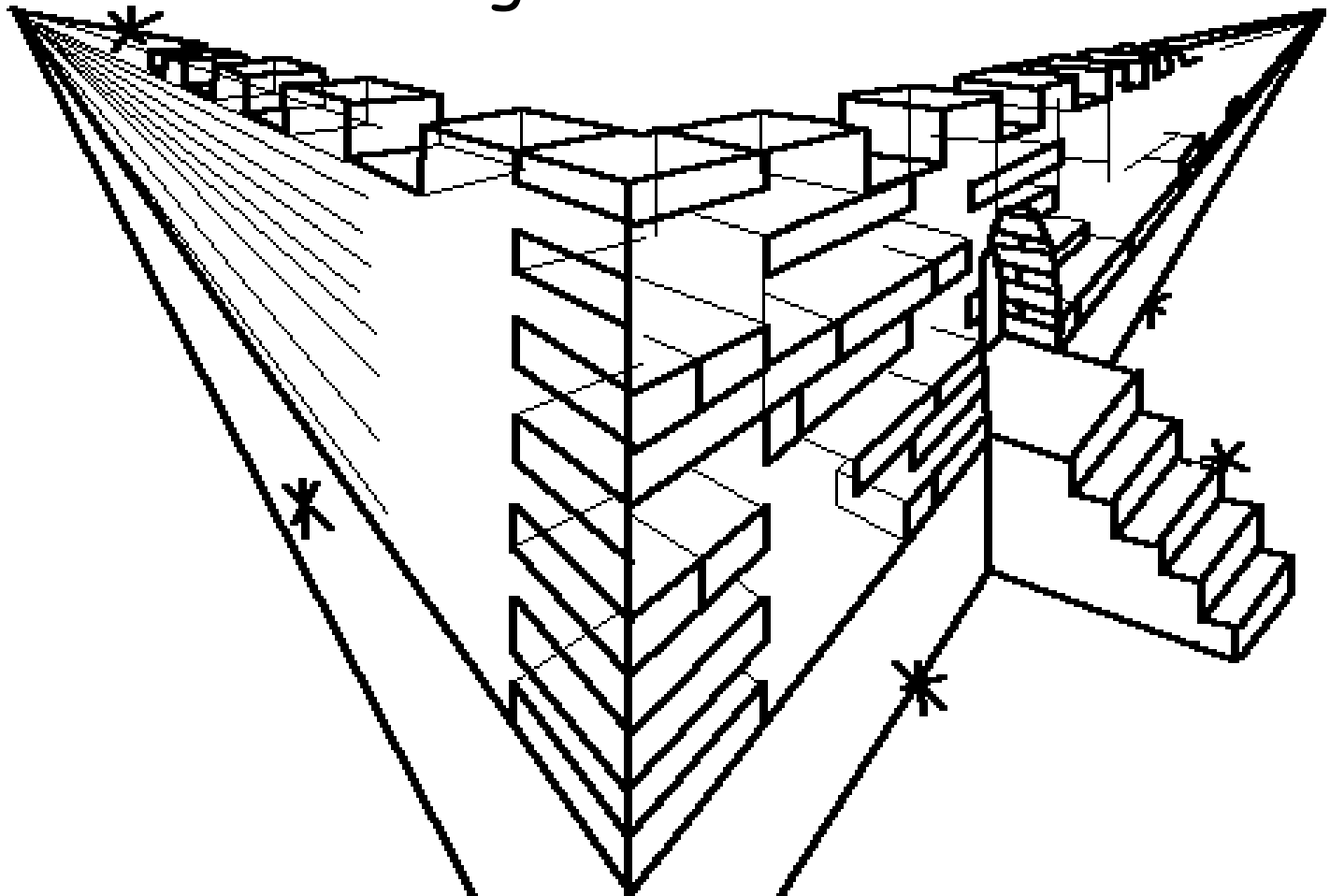

Baté-baté permata dan baté-baté mulia
beulapeueh pondasi nibak binteueh nyan, nyang
meuengkilat deungoen warna-warna nyang jidah.
Maséng-maséng gerbang-gerbang banda teupeuget
nibak mutiara nyang lheu

that!

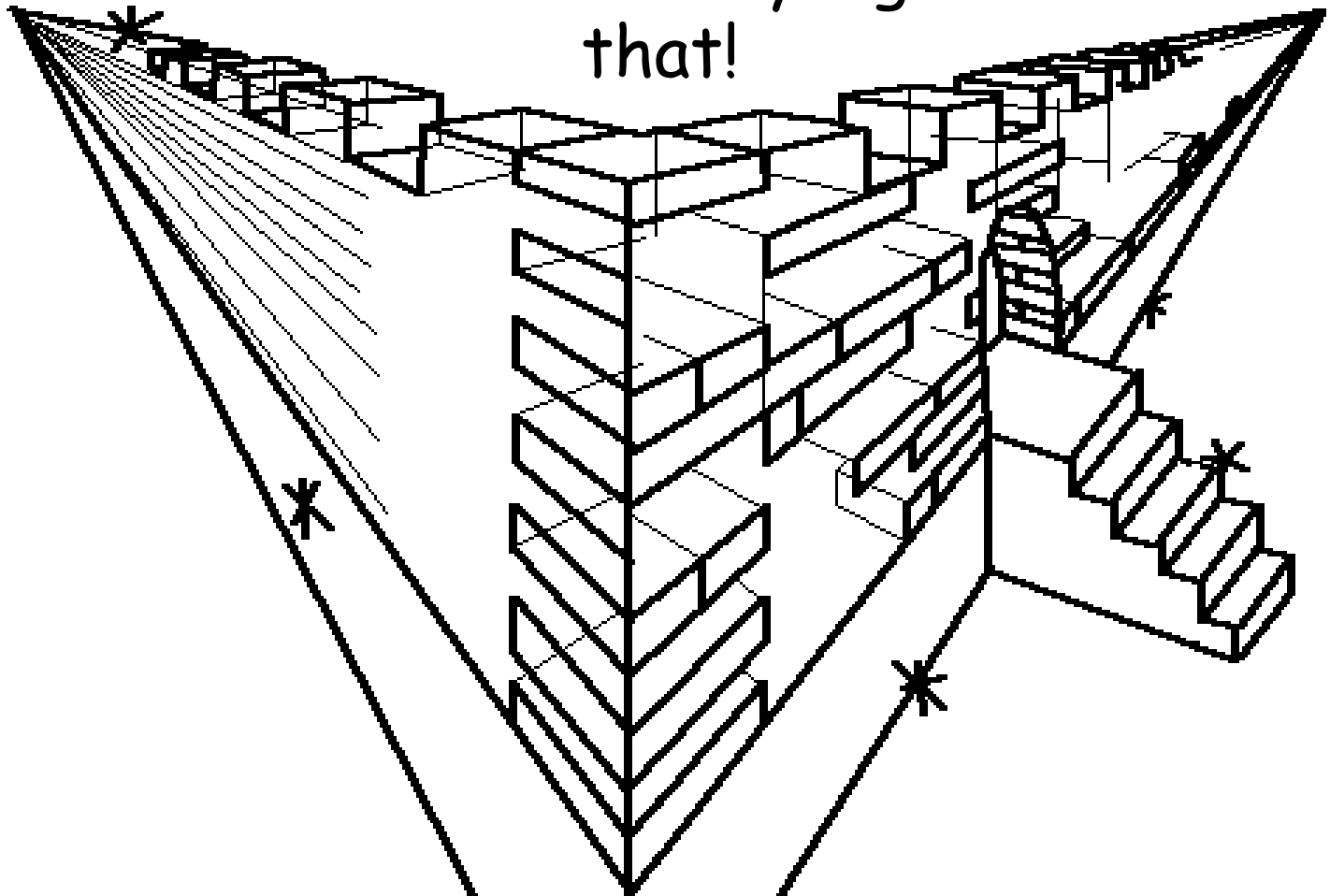

Gerbang mutiara nyan hana pernah geututöp.
Keunoe tamoeng dan geukalon seukelileueng, ...
Wow. Syuruga teukalôn leubeh lagak nibak dalam.
Banda teupeuget nibak méuh murni, lagée gaca
nyang jerneuh,
malahan
rét-rét
jipeuget
nibak méuh.

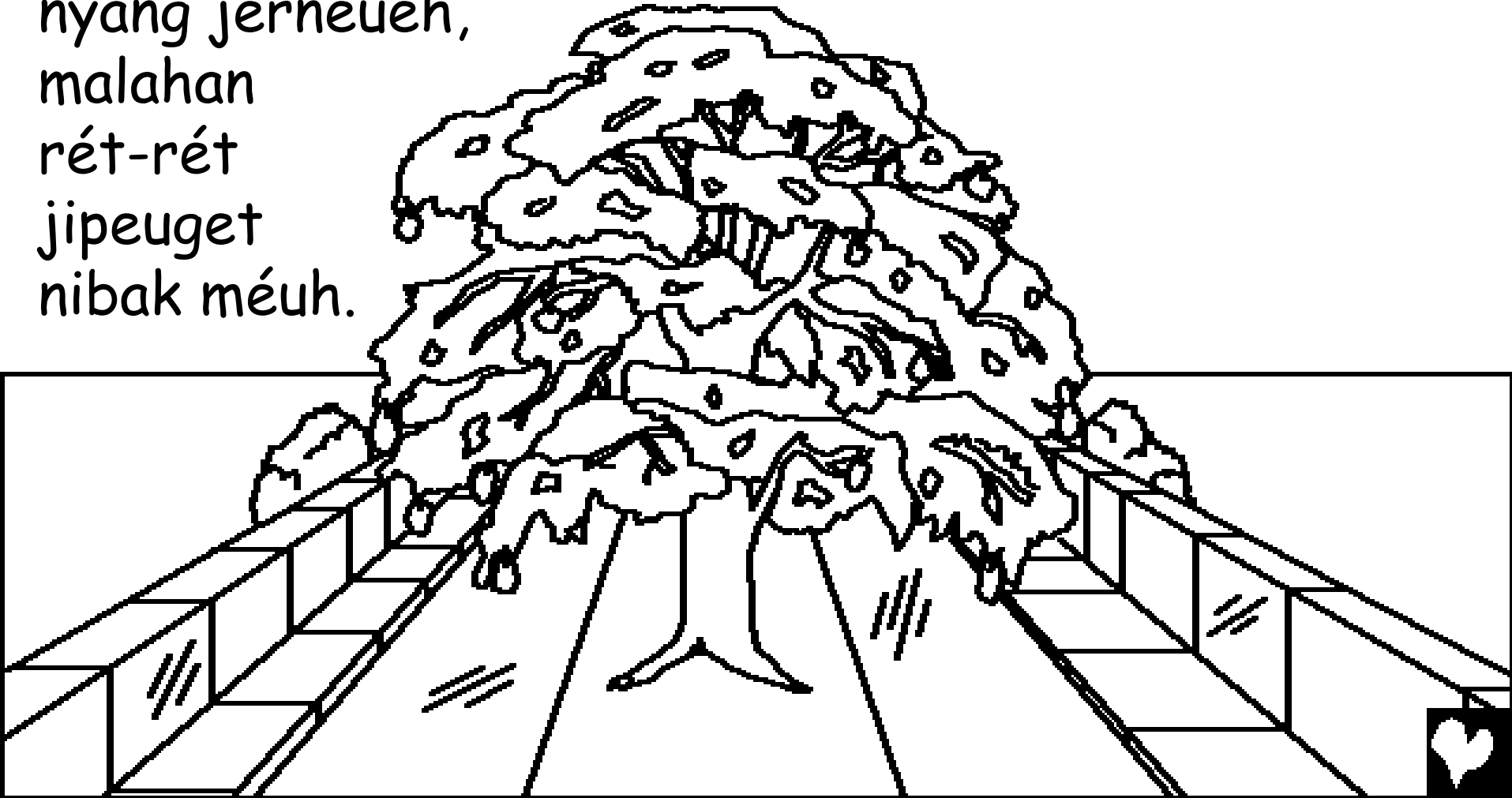

Lagak that. Ié krueng keu-udéb nyang gléuh
geu-ileu nibak keurajaan Allah. Bak bineueh nyang
laen nibak krueng nyan na bak kayée keu-udéb,
nyang phon jimurumpôk di taman syuruga. Bak
kayée nyoe special that. Teudoung nibak dua blah
bôh-bôh nyang hana sama. Dan ôn-ôn nibak bak
kayée keu-udéb nyoe keu peupuleueh
bangsa-bangsa.

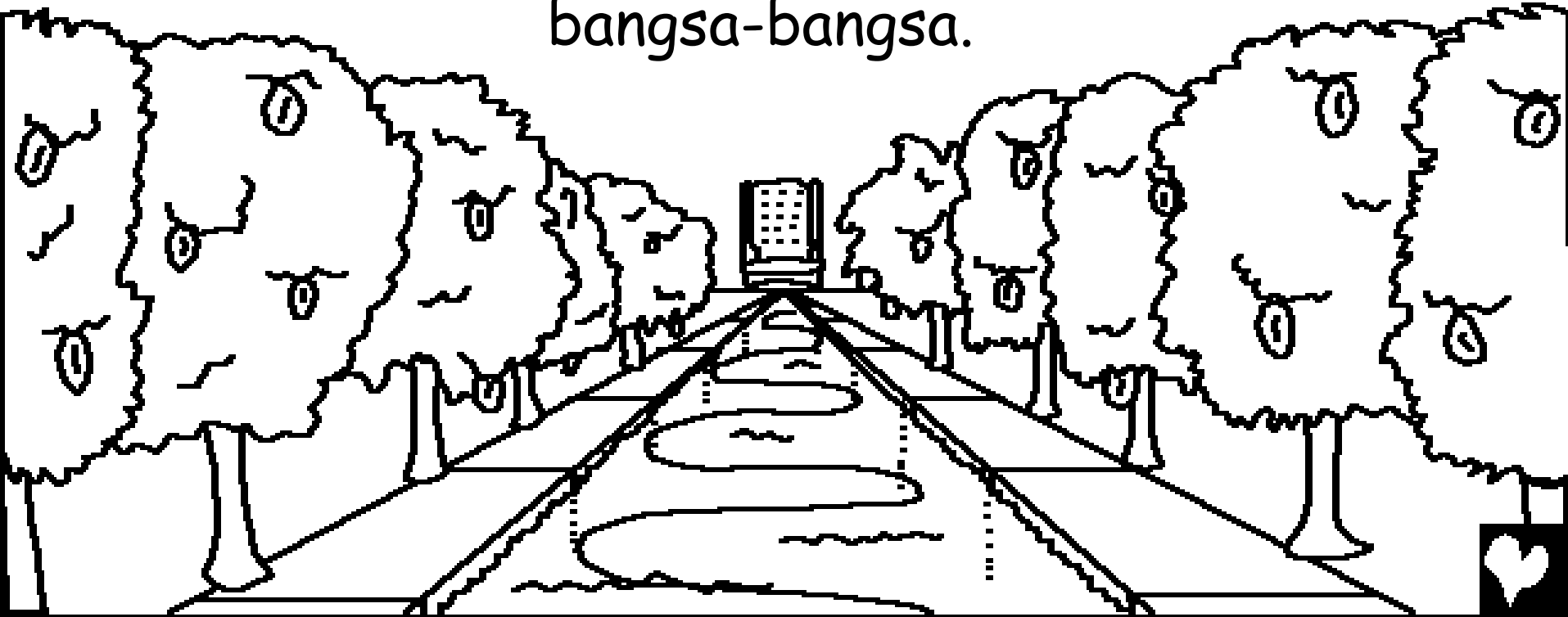

Syuruga hana geupeureleu mata uroe atau buleuen seubagoe trang. Keumulian Allah geupeupunoeh deungoen trang nyang jidah. Di syideh hana malam uroe.

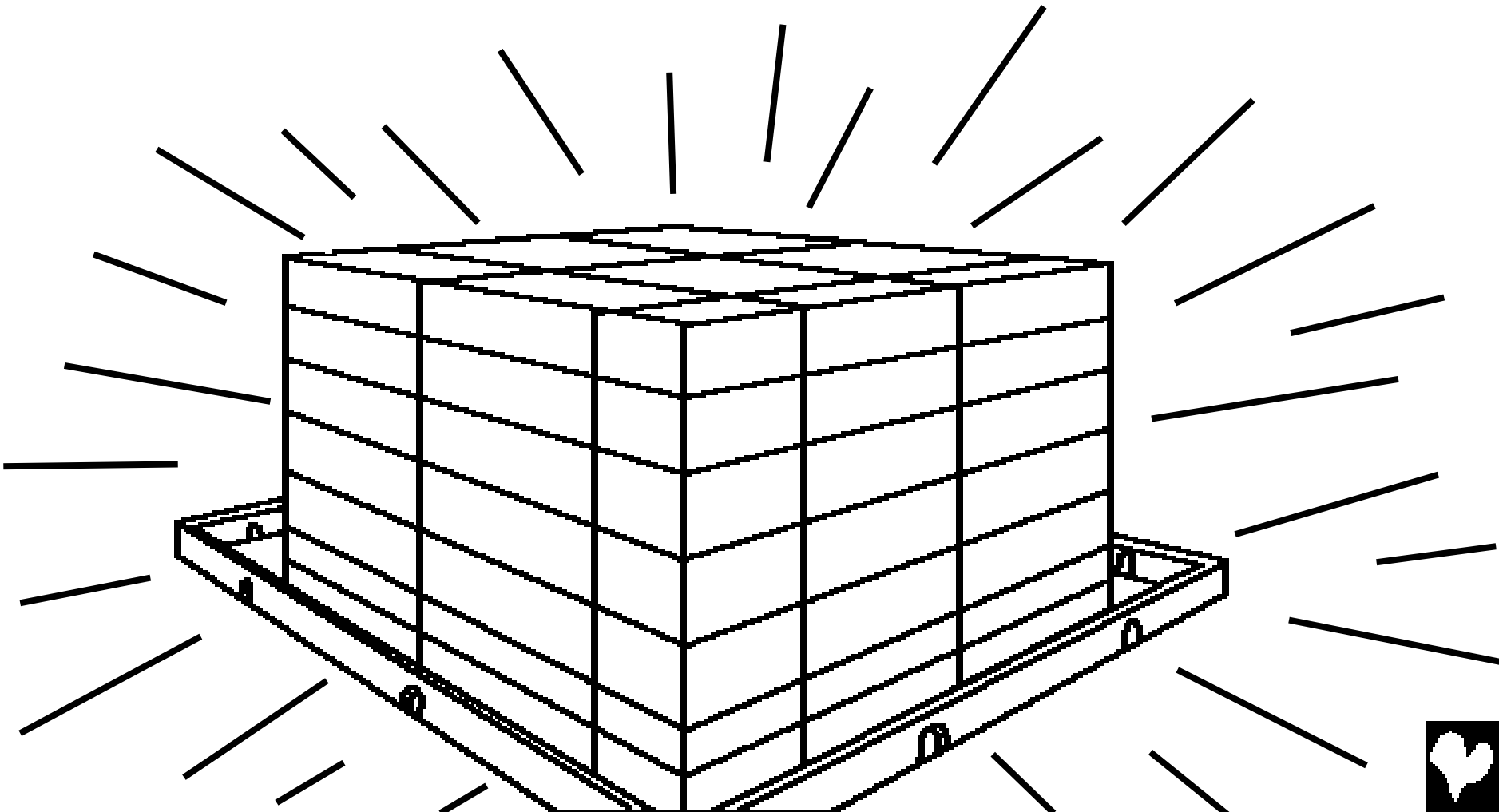

Meunan cit beulatang-beulatang jilam syuruga
meulaén-laén. Awaknyan banmandum jinak
dan meungoun. Seurigala dan bubiri-bubiri
pajôh laleueng meusajan-sajan dan nakheueh
singa-singa pajôh jeurami lagée leumo agam.
Allah geufeuroman, "Awaknyan mandum
hana nyang teuluka atauwa binasa di
gunông-Loen
nyang suci."

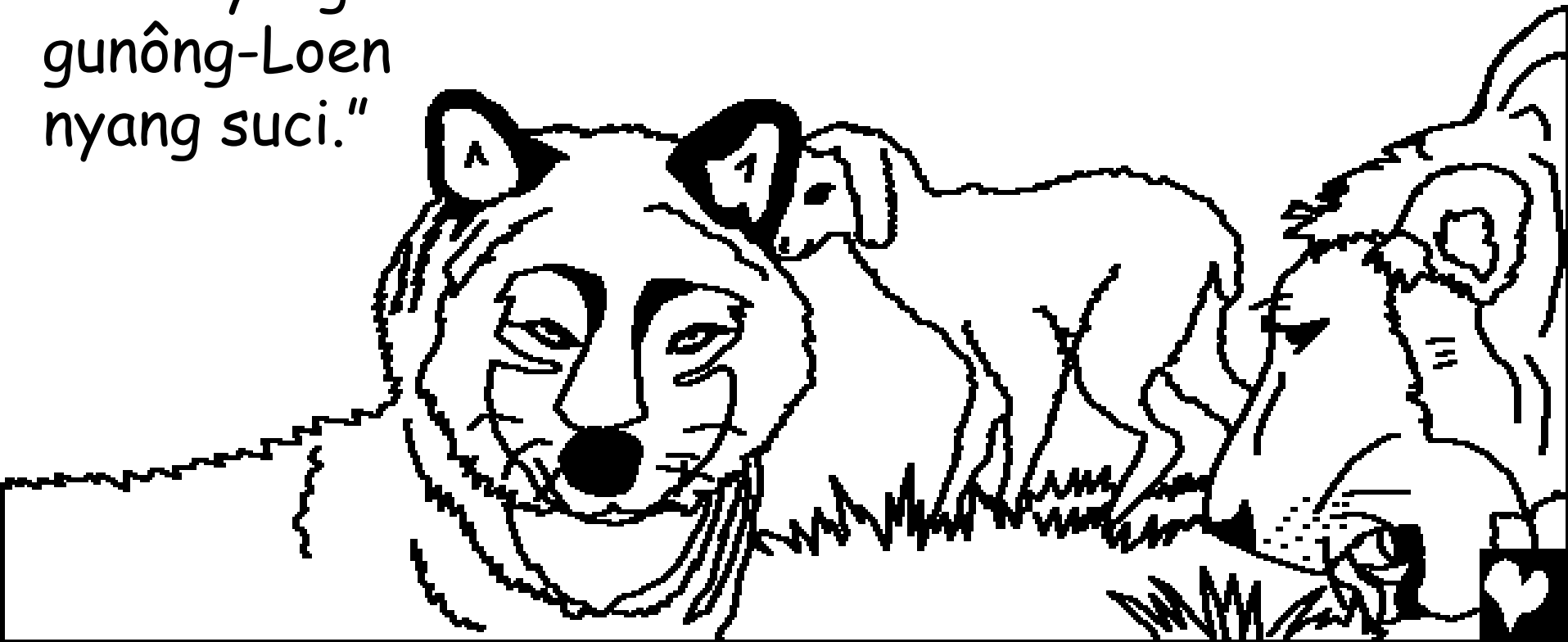

Lagéé nyang geutanyoe kalön, geutanyoe meucatat
bahwa di syideh hana meusaboeh nyang gadoh nibak
syuruga. Hana su-su
beungeueh
nyang
seureueng
tadeungou.

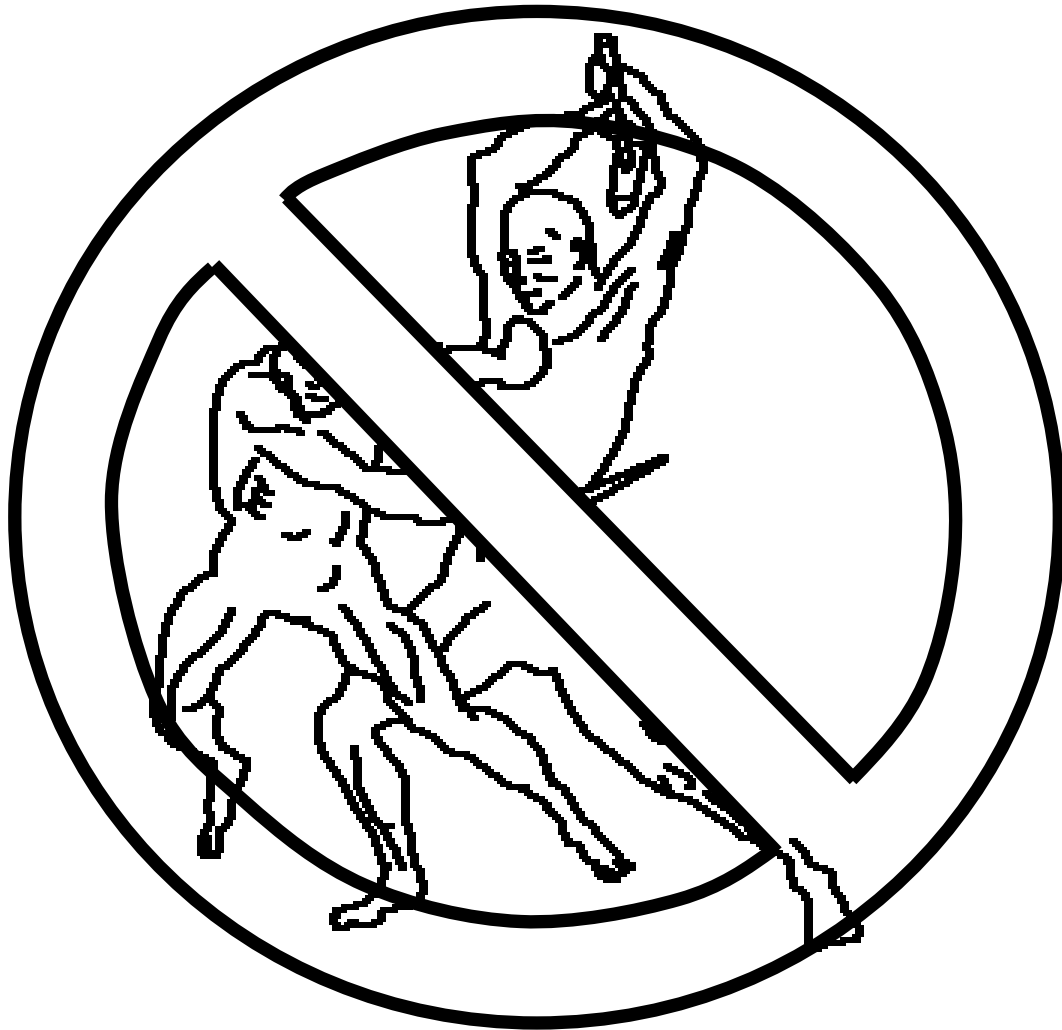

Hana meusidroé nyang meupakée atawa
geupenteueng droe kedroe. Di syideh pintoe-pintoe
hana teukunci kareuna hana peucuri jilam syuruga.

Hana peundusta,
peubunoeh,
tukang
siher
atawa
ureueng
-ureueng
jahet.
Hana
desya
jilam
syuruga.

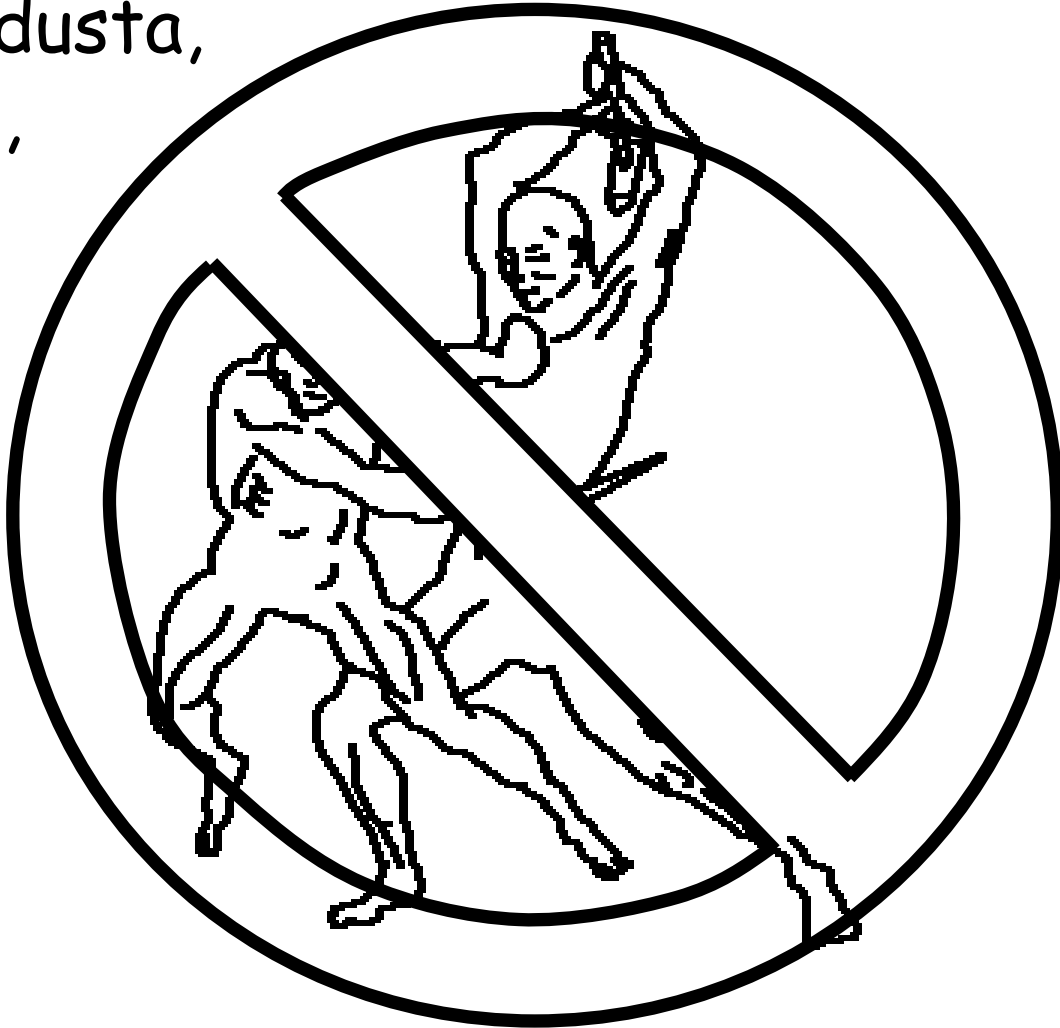

Di lam syuruga
meusajan-sajan deungoen
Allah hana lée ié mata.
Kadang-kadang, umat Allah
geumou karena deurita lam
udéb nyoe. Di lam syuruga
Allah teuma geuapoe
mandum ié mata.



Hana meuninggai jilam syuruga. Umat-umat Allah
teuma seulama-lamajih meusajan deungoen Allah.
Di syideh hana seudèh hatèe, hana nyang
moe, hana nyang luka.

Hana peunyakét,
hana peupisahan,
hana nyang jikubu.

Tiép ureueng
seulama-lamajih
beubahgia
meusajan
deungoen
Allah jilam
syuruga.



Banmandum nyan get. Syuruga keu agam dan inong
nyang peucaya bak Isa Almaseh seubagoe juru
peuselamat dan geutaát-Gobnyan seubagoe
Tuhan-jih. Jilam syuruga na bukoe nyang jipeugah
seubagoe bukoe keu-udéb aneuek bubiri,
nyang peunoeh deungoen nan-nan tiép
ureueng. Pu kheueh Gata teupeu
nan-nan soe nyang
teutuleueh di
syideh? Banmandum
ureueng-ureueng
nyang peucaya bak
Isa na di syideh.. Pu
kheueh nan droeneuh
na cit di syideh?

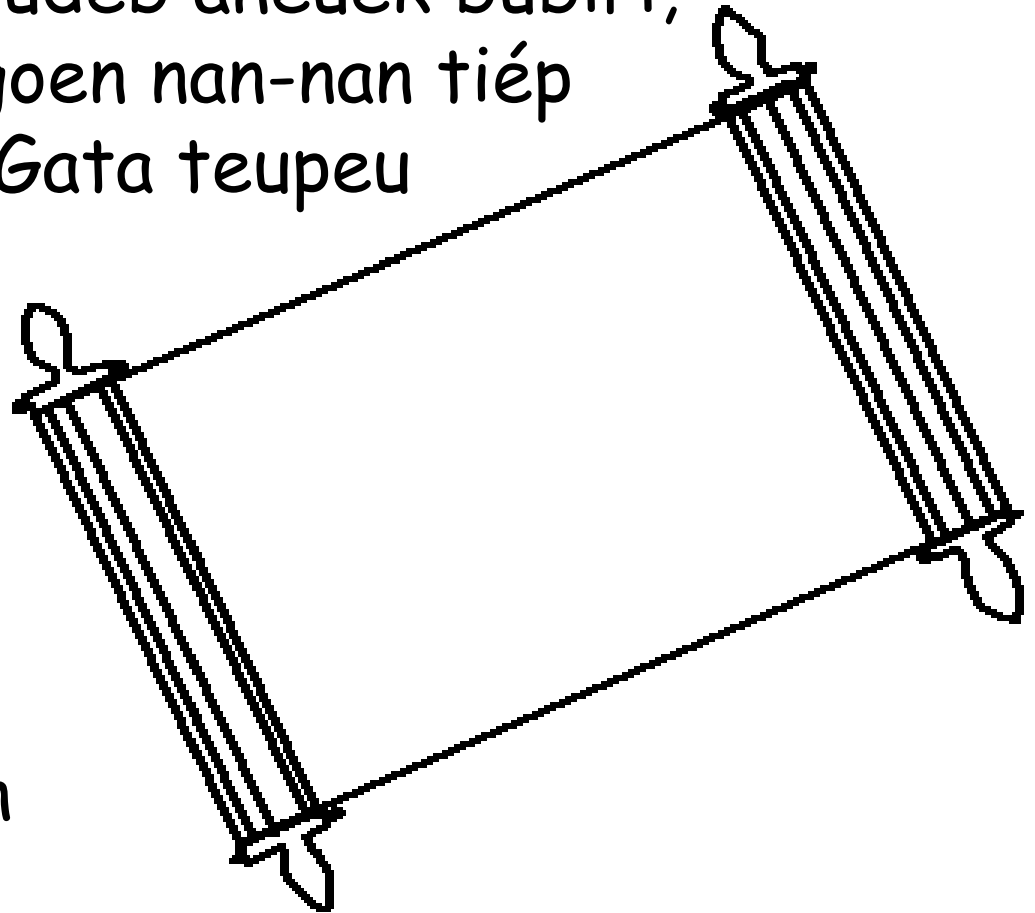

Feureuman Allah di lam Alkitab nyang paléng
akhe geucalitra bhaih syuruga nakheueh
saboeh undangan nyang teulagak.

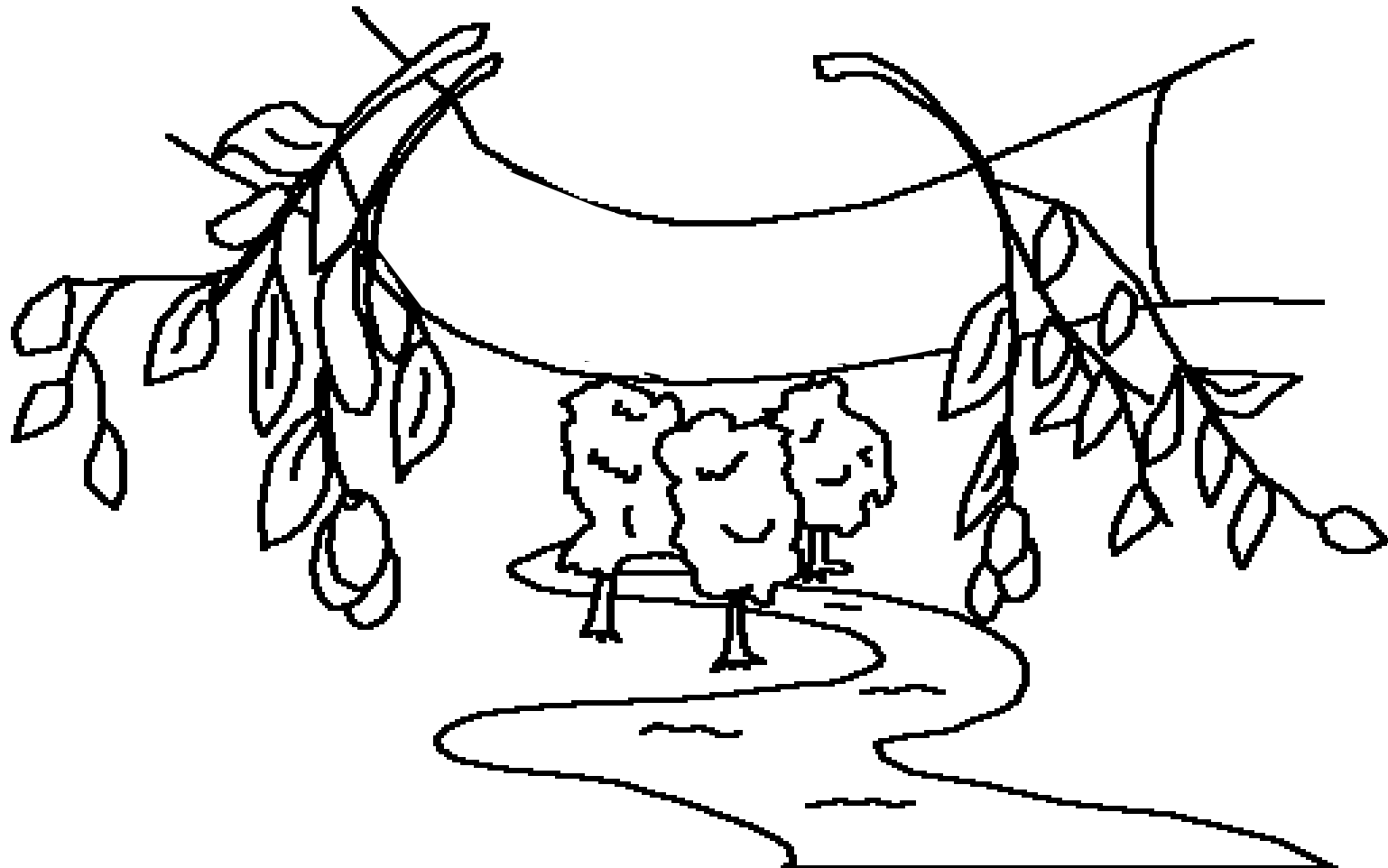

"dan Roh Suci ngon meupeulai nyan geukheuen,"
'keunou jak!' dan bakheueh jih nyang geudeungoe
'keunou jak' dan bakheueh jih nyang grah. Dan soe
manthong nyang keumeueng, bakheueh jih geujèep
ié keu-udéb deungoen beubah."

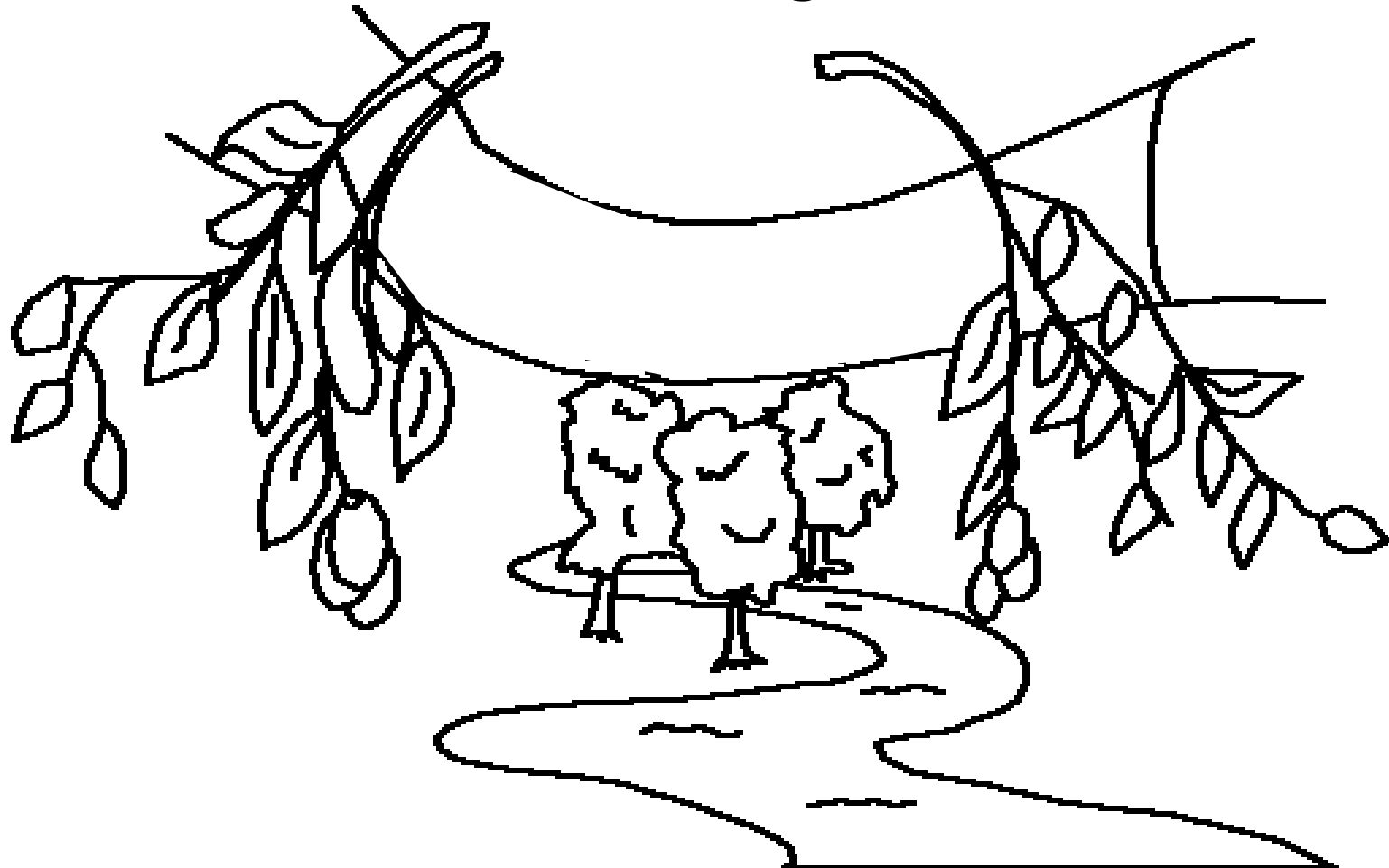

Syuruga, Rumoeh Allah nyang lagak

Saboeh kisah nibak feureuman Tuhan, Alkitab,

jiteumeung jidalam

Yahya 14, 2 Korintus 5, Wahyu 4, 21, 22

"Feureuman Droen neujok peunerang."

Zabur 119:130



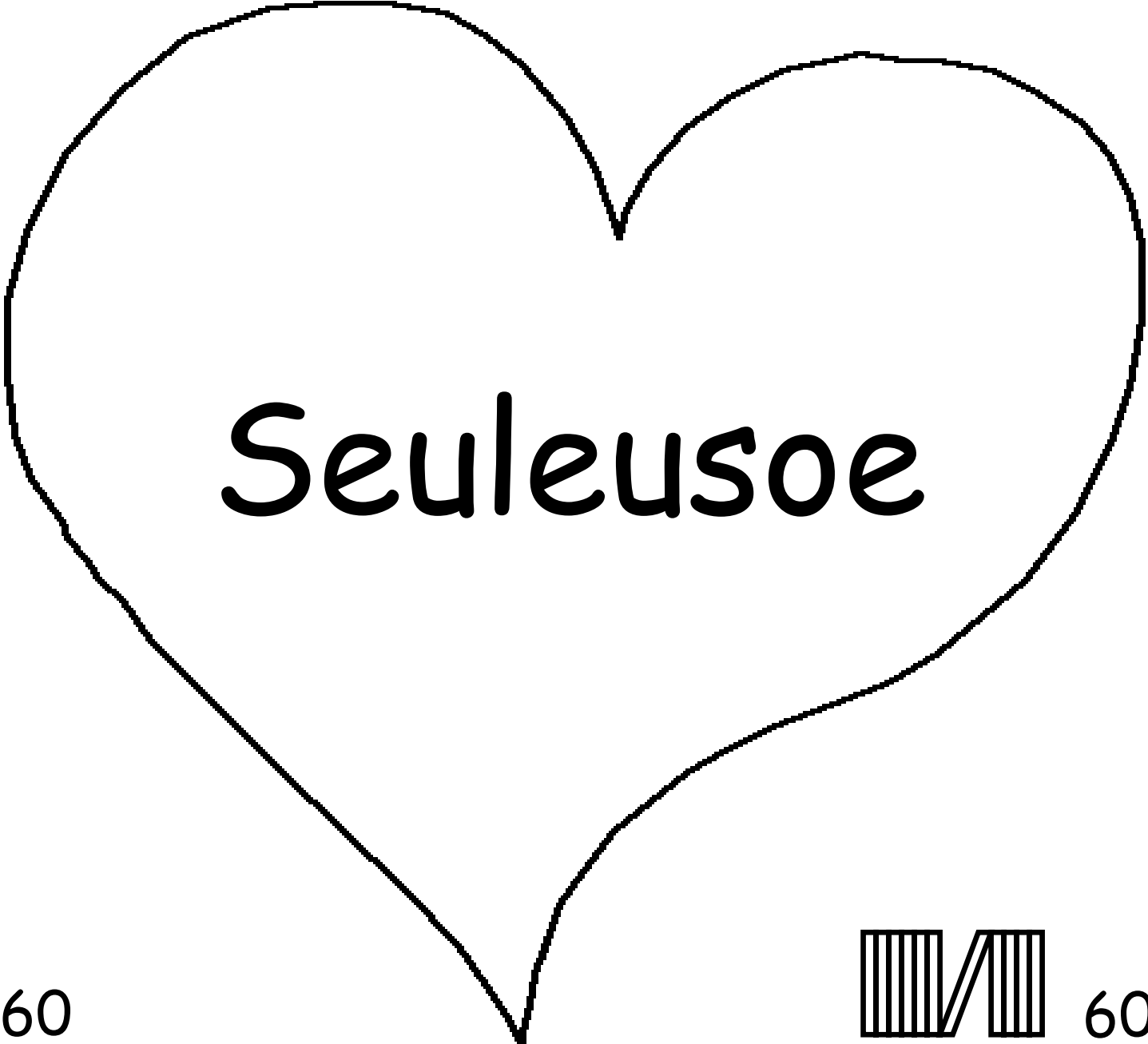

Seuleusoe

60

60



Calitra Alkitab jisinoe teukisah bak geutanyoe bhaih Allah Geutanyoe nyang lua biasa jeuet gata thürie-Gobnyan.

Allah geuteupéu geutanyoe ka tapeuget buet-buet nyang jahèt, nyang dipeugah lè Gobnyan desya. Huköm desya na kheueh mawöt, tapi Allah geugaseh that gata, Gobnyan geu-utus Aneuek Gobnyan nyang sidroe, na kheueh Isa, keu matéé jiateuh kayée saleb dan ji huköm kareuna desya-desya gata, oh lheueh nyan udéb lôm dan ék u syuruga! Meunyoe gata peucaya bak Isa dan geulakée peuamphonan Gobnyan ateueh desya-desya gata, Gobnyan teuma geupeuamphon! Gobnyan teuma trôk dan udéb lam gata dan gata teuma udéb meusajan-sajan ngon Gobnyan seulama jih.

Meunyoe gata peucaya nyoe na kheueh keubeunaran, beudoa lagée nyoe bak Allah: Tuhan Isa, loen peucaya bahwa Droen na kheueh Allah, nyang ka jeaet manusia keu matéé bagi desya-desya uloen, dan jinoe Droen bangkét. Keunoe geutamong u lam udéb loen dan peuamphon desya-desya loen, jeaet loen na udéb nyang baroe, dan saboeh masa jak meusajan-sajan ngon Droen seulamajih. Tuloeng loen keu ta`at bak Droen dan udéb keu Droen sebagoe aneuek Droen, Amin.

Baca Alkitab dan mariep ngon Tuhan tièp uroe! Yahya 3:16

