

Bibel tu angka dakdanak  
patomutomuhon

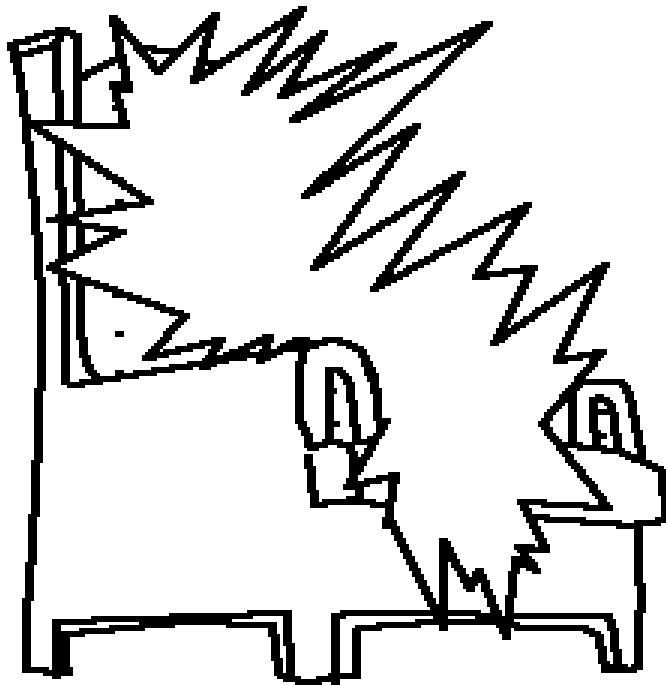

Banua Ginjang  
(Surgo), Huta  
Nauli ni  
Debata



Sinurathon ni: Edward Hughes  
Illustrasi sian: Lazarus  
Sinadur ni: Sarah S.  
Nihatabatakxon ni: Marihot Siahaan  
Hinaruarhon ni: Bible for Children  
[www.M1914.org](http://www.M1914.org)

BFC  
PO Box 3  
Winnipeg, MB R3C 2G1  
Canada

©2011 Bible for Children, Inc.

Ijin: Manang ise pe, boi do mamotokopi manang pagandahon cerita on,  
asal ma unang digadis.



Di tingki di tano on dope Jesus nunga  
dipaboa tu angka siseanNa taringot  
tu Banua Ginjang. Didok Ibana ma  
i "Bagas ni AmangKu", jala didok  
adong godang inganan disi.

Sada inganan na balga,  
huta na uli. Umbalga  
jala ummuli do Banua  
Ginjang sian huta  
di tano on.



Didok Jesus ma, "Na laho ma Ahu paradehon inganan di hamu. Jala molo laho ahu jala huparade inganan di hamu, ro do Ahu muse jala jaloonku ma hamu tu diringku."



Laho ma Jesus tu Banua Ginjang, dung hehe Ibana sian hamatean. Di tingki pungu angka siseanNa i, tarhinsat ma Jesus, jala diboan ombun ma Ibana onding sian mata nasida.



Dung i, nunga diingot halak Kristen janji ni Jesus,  
na ro do Ibana muse mangalap nasida. Didok  
Jesus, tompu do Ibana ro muse, di tingki so  
panagaman. Alai boha do taringot  
tu halak Kristen naung monding  
andorang so ro dope Ibana?  
Bibel mandok, laos rap  
dohot Jesus nama  
nasida laho. Nandang  
ro di bagasan

daging lapatanna  
ro raphon  
Tuhan i.



Pangungkapon, i ma buku na parpudi Bibel,  
pabotohon tu hita hinauli ni Banua Gintang.  
Apala na andul ummuli i, Banua Gintang do  
huta ni Debata. Adong do nian Debata  
di sude inganan, alai anggo  
habangsaNa I ma di  
Banua Gintang.

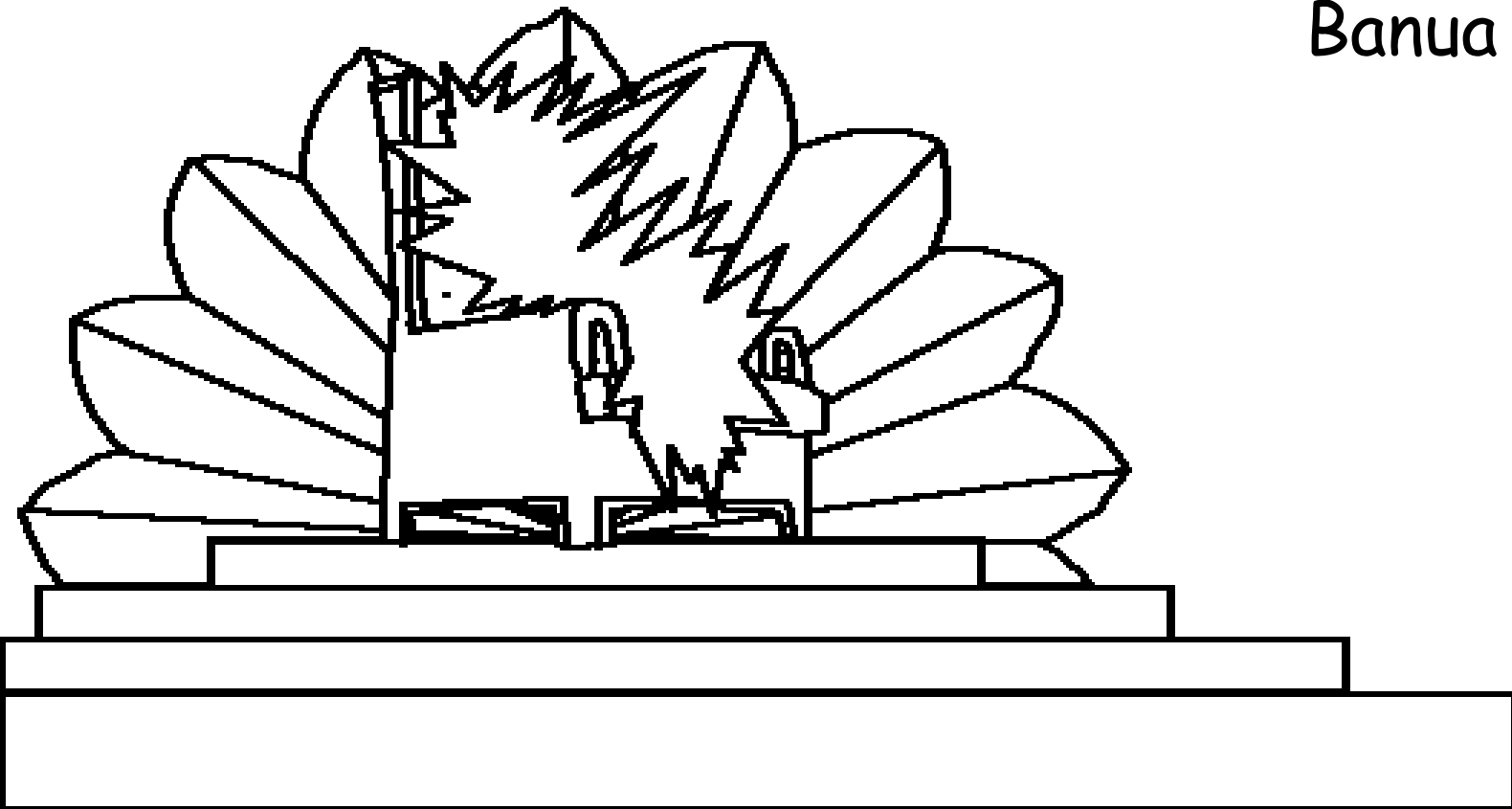

Surusuruan dohot parangan parbanua  
ginjang mamuji Debata di Banua  
Ginjang. Songon i ma dibahen  
angka bangso ni Debata angka  
naung mate jala naung laho tu  
Banua Ginjang. Nasida  
mangendehon  
angka ende  
pujipujian  
tu Debata.

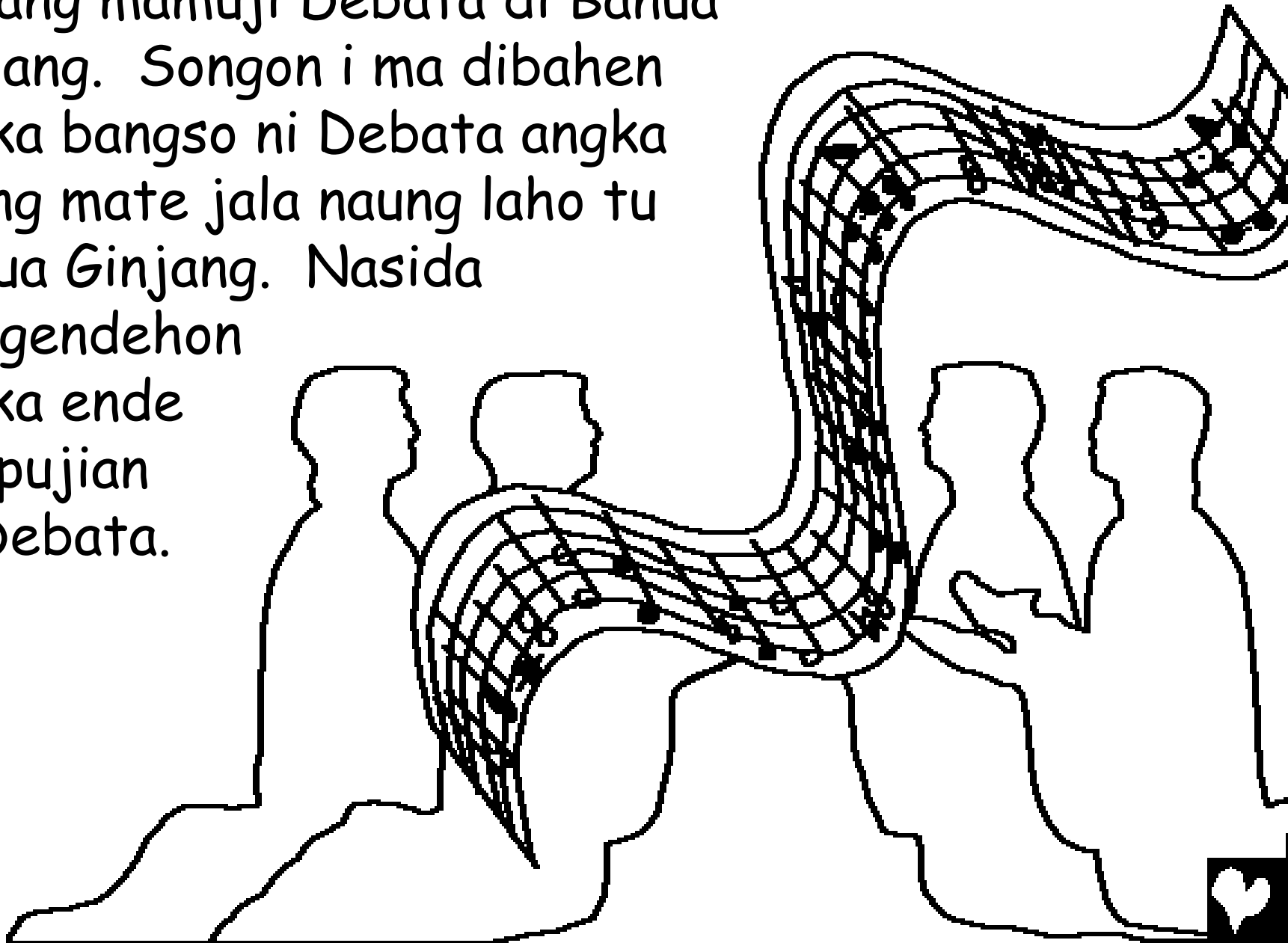



On ma hata ni sada ende na niendehon nasida: AI  
NAUNG TARBUNU DO HO JALA MARHITE  
MUDARMU DITOBUS HO DO  
TU DEBATA JOLMA SIAN  
SALUHUT MARGA, HATA,  
HOUM DOHOT BANGSO.  
JALA DIJADIHON HO DO  
NASIDA GABE  
HARAJAON  
HAMULIAON  
NI DEBATA.  
(Wahyu  
5:9-10)

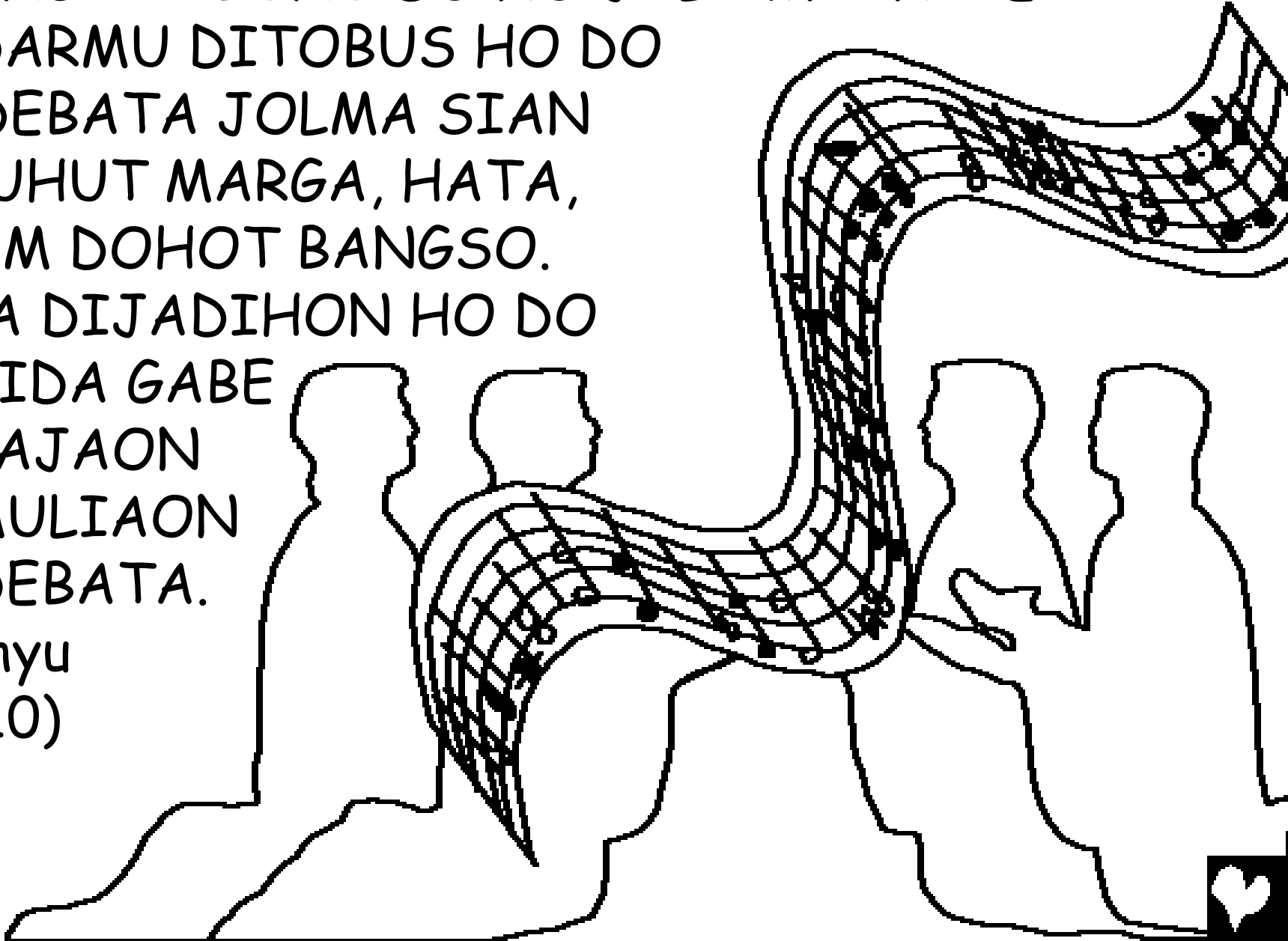

Apala halaman na parpudi sian Bibel manggombaron  
Banua Gijang songon "Jerusalem Na Imbaru". Tung  
mansai balga, jala marparik na timbo do i di duru.  
Parikna i sian batu na uli, na marhillong. Angka intan  
dohot batu na arga mangalapis dasar ni parik i,  
rupana marhillong

jala  
uli.  
Ganup  
harbangan  
dibahen  
sian mutiara  
tunggal  
na balga.

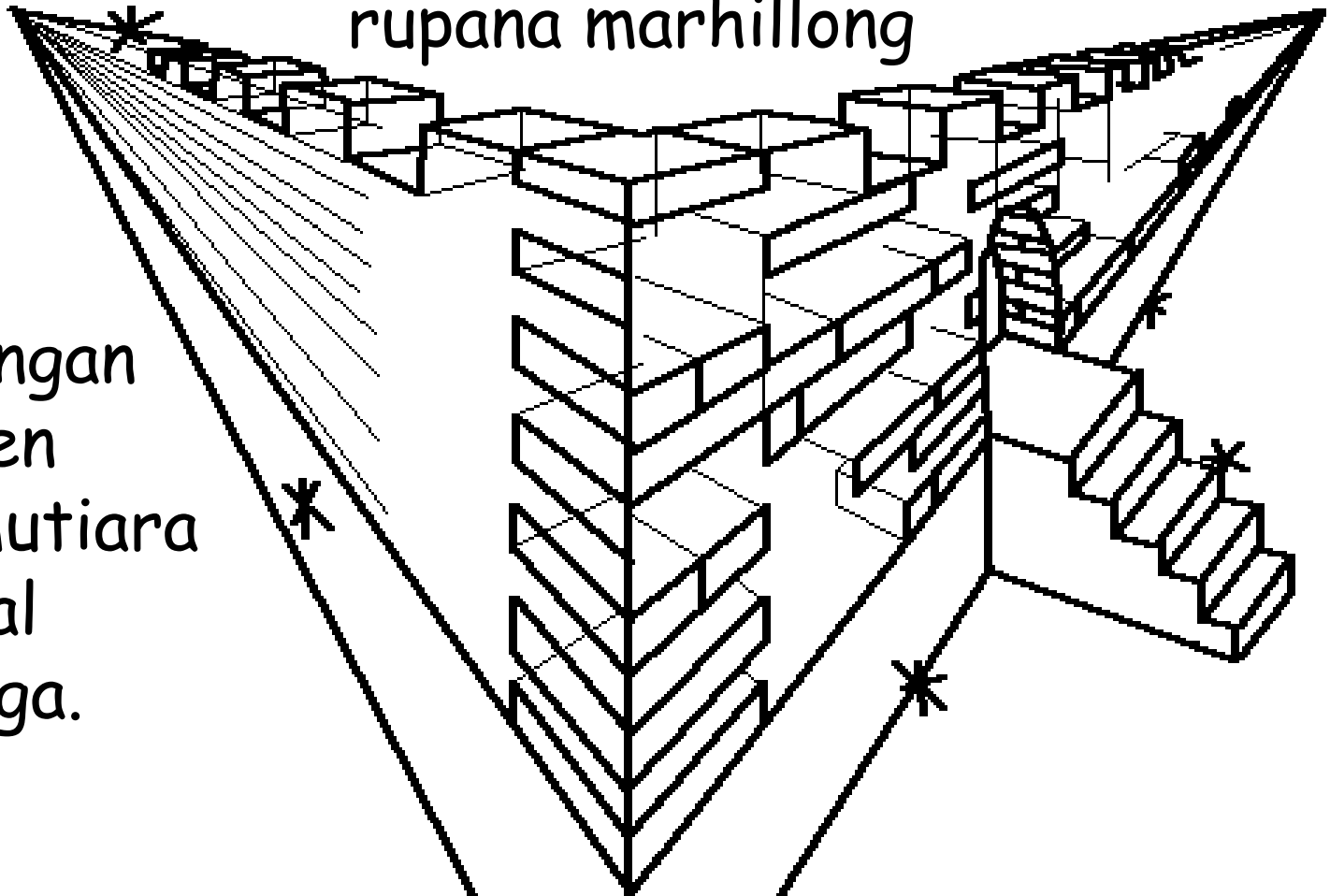

Angka harbangan na sian mutiara i ndang hea  
martutup. Beta hita masuk tu bagasan jala taida  
humaliang...O uli ni! Ummuli muse dope surgo i di  
bagasan. Dibahen do huta i sian mas tulen, songon  
galas na tio. Gari  
dalan pe dibahen  
sian mas.

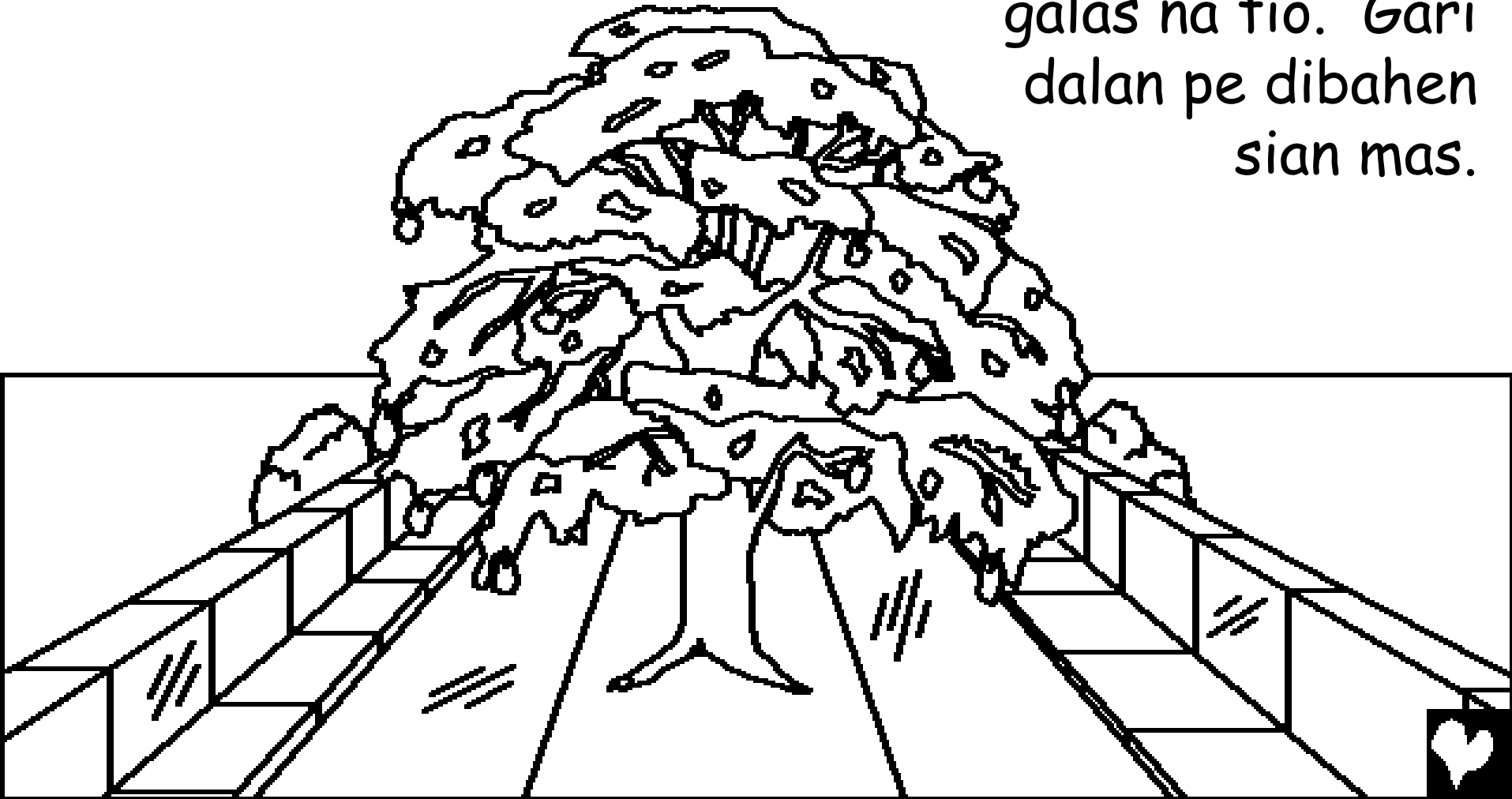

Sada sunge na uli jala na tio sian aek hangoluan mabaor sian habangsa ni Debata. Di bariba ni aek i adong do hau hangoluan, i ma na adong di mulana i di Porlak Eden. Mansai andul do hau i. Marparbuehon sampulu dua ragam na marasing, songon ragam ni ganup bulan. Jala bulung ni hau hangoluan i gabe pandaoni ni ganup bangso.

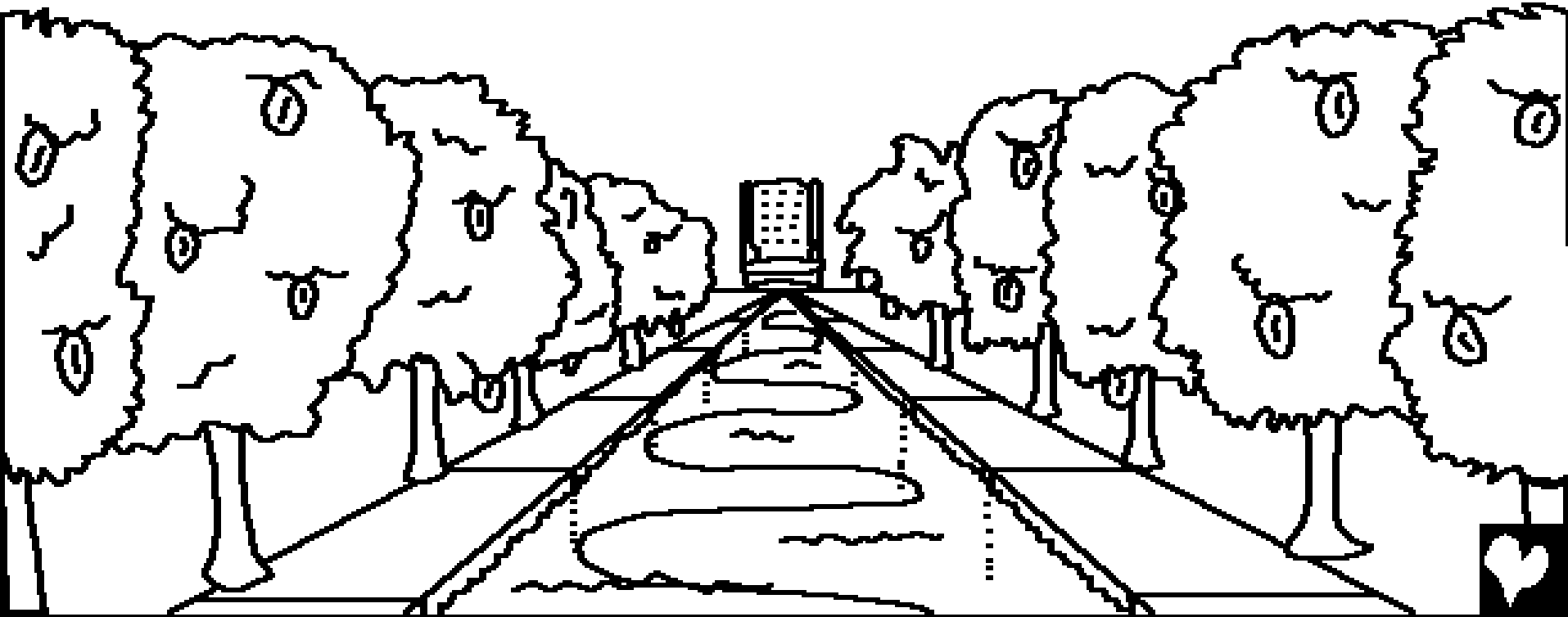

Ndang porlu be di Banua Ginjang mata ni ari manang bulan laho manondangi. Hamuliaon ni Debata do manggohisa dohot sinondang na tung mansai tiur. Ndang adong be borngin disi.

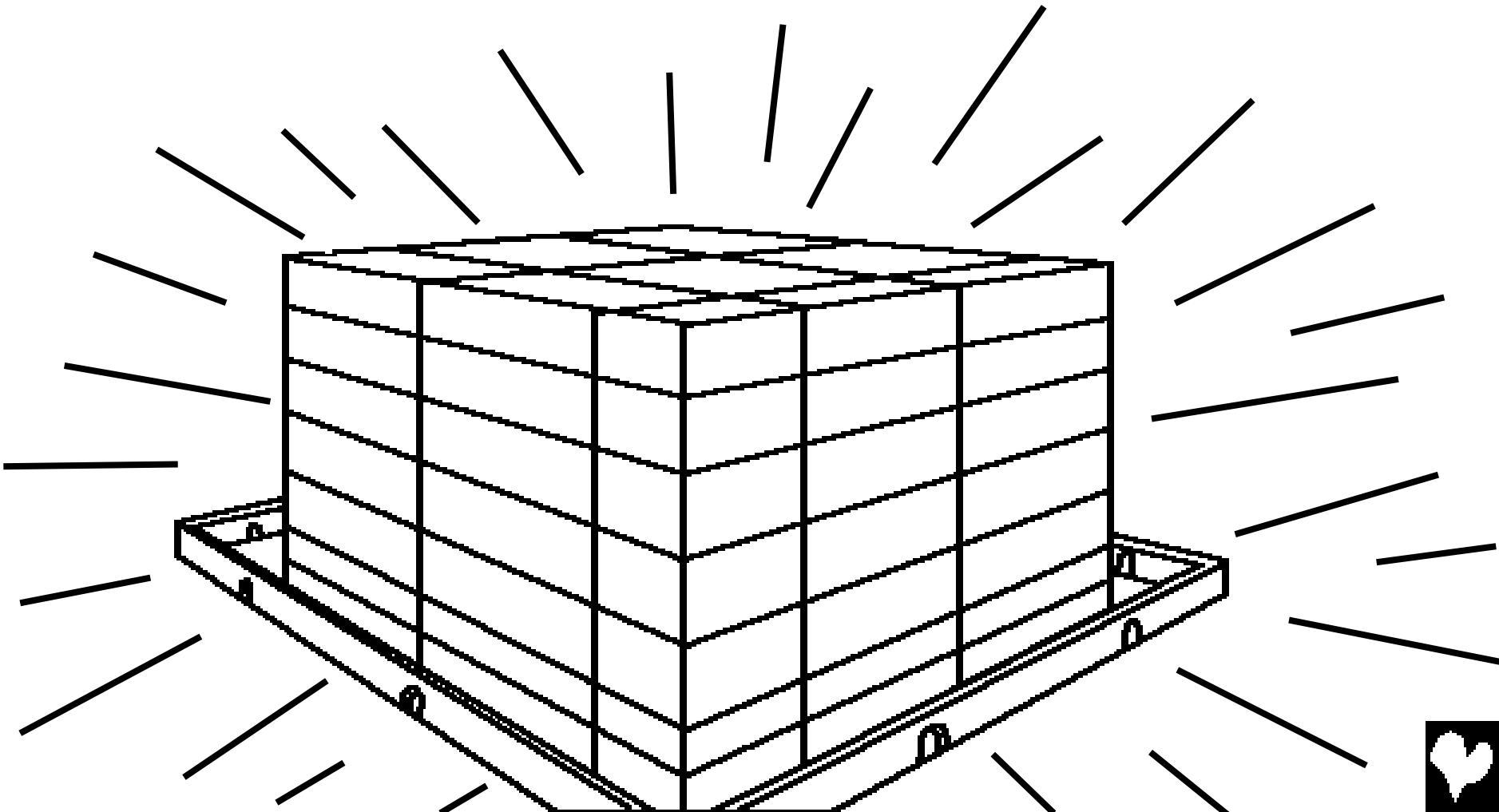

Gari angka binatang na di Banua Ginjang i nunga asing. Sasudena jinak jala maraleale. Sorigala dohot birubiru rap manggagat. Gari singa manganhon durame songon lembu. Ninna Tuhan i, "Ndang masiharatan jala ndang masibunuan be nasida di angka dolok habadiaonKu."

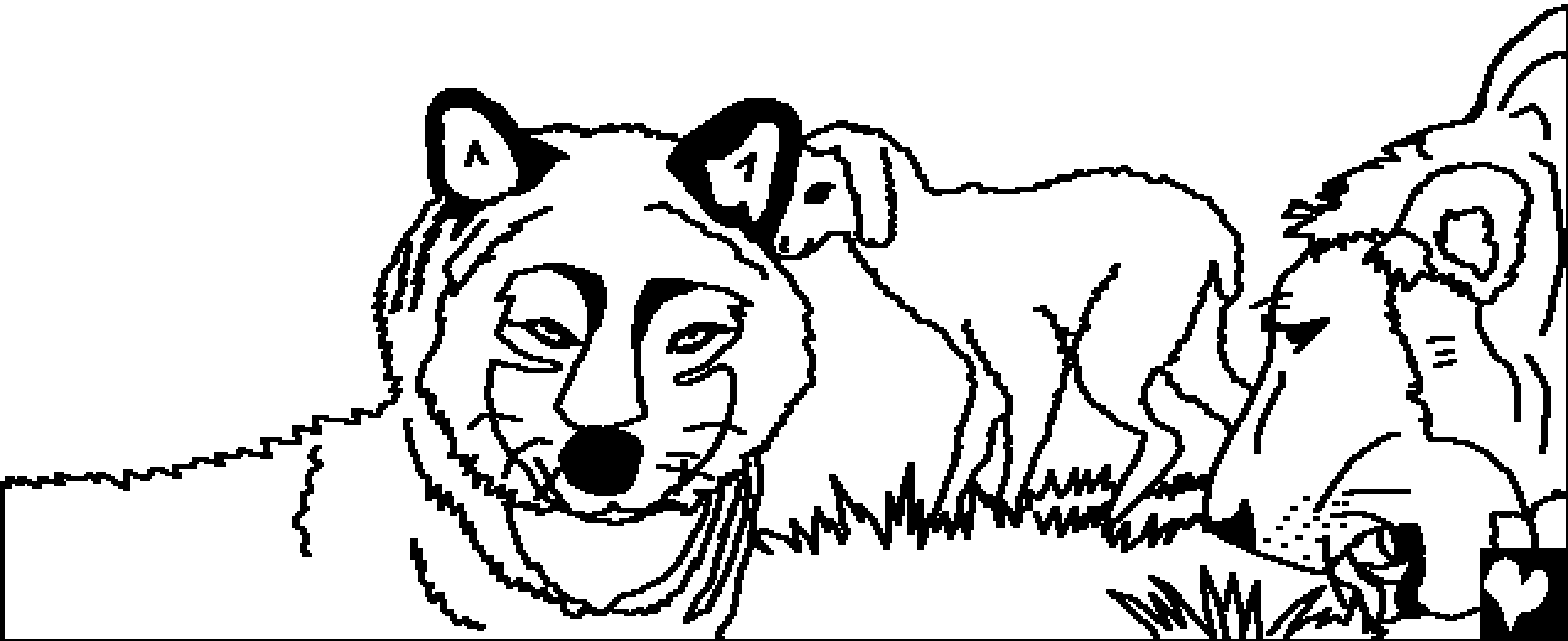

Dung taida humaliang, taida ma adong  
do na mago sian Banua Gintang.

Ndang adong be  
hata muruk  
begeon.

Ndang  
adong na  
marbada  
manang  
na holan  
manarihon  
dirina.

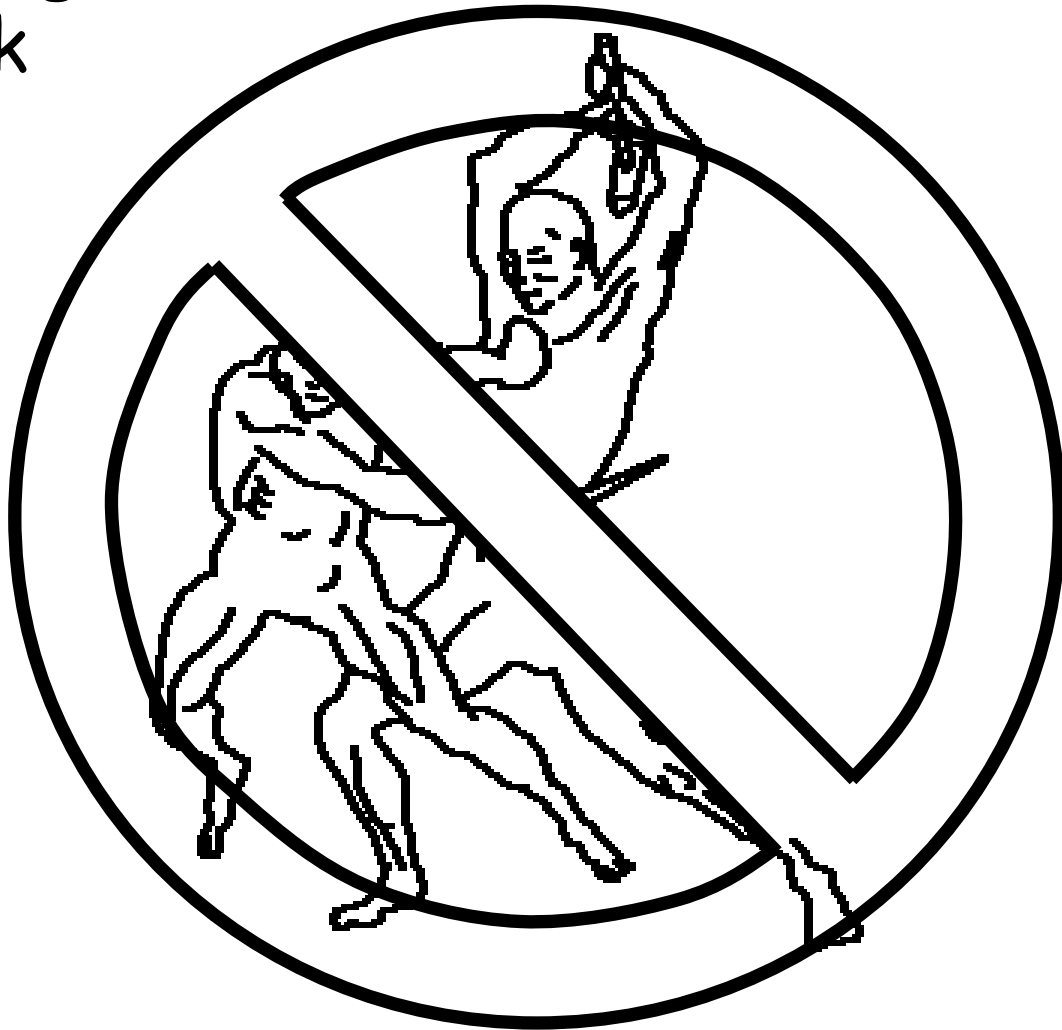

Ndang adong be kunci di angka pintu, ala ndang adong panangko di Banua Ginjang. Ndang adong pargabus, pamunu, partondung, manang angka parjahat na asing. Ndang adong be dosa di Surgo i.

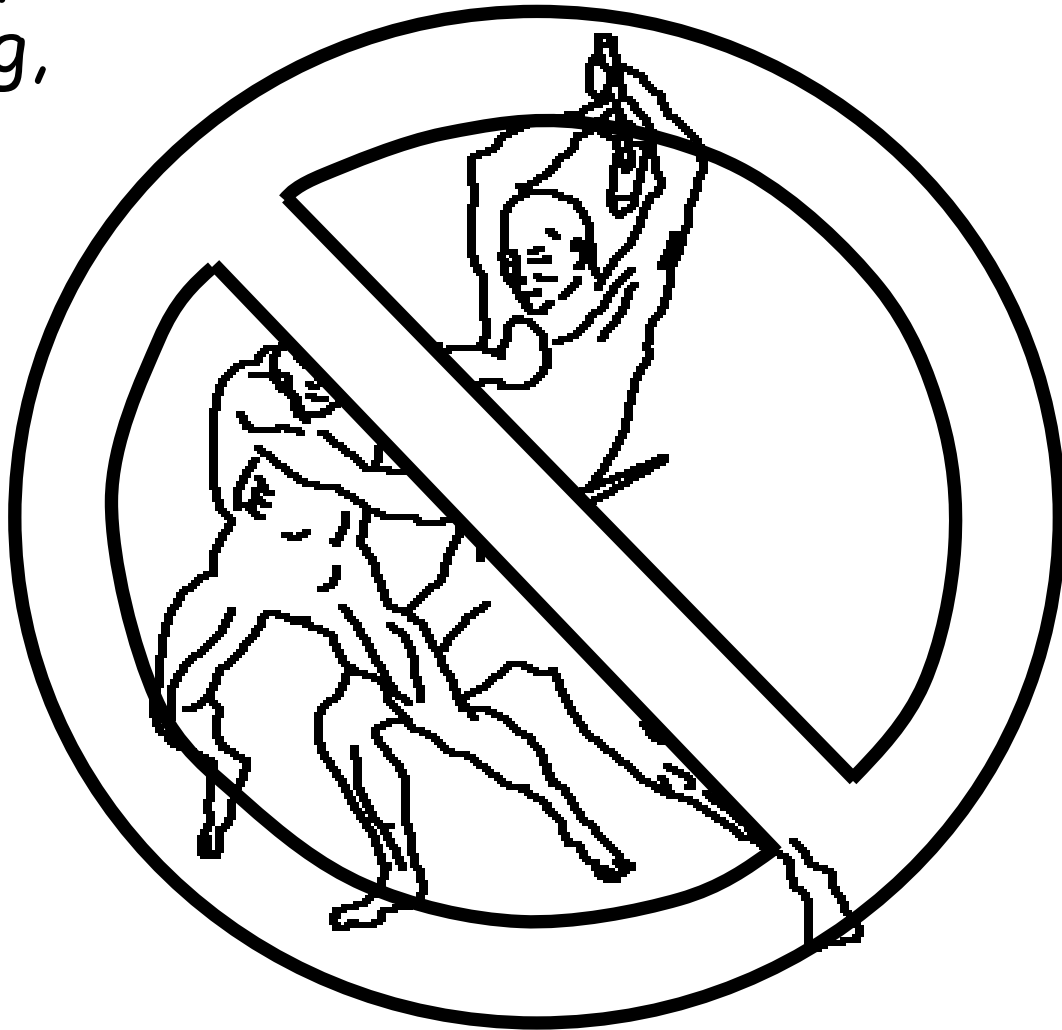



Di Banua Ginjang, rap dohot  
Debata ndang adong be iluilu.  
Sipata, joujou do bangso ni  
Debata ala borat ni sitaonon di  
ngolu on. Di Banua Ginjang  
diapusi Debata do nasa ilu.



Ndang adong be nang hamatean di Surgo.  
Manongtong ma bangso ni Debata rap dohot Tuhan i.  
Ndang adong be sitaonon, ndang adong partangison,  
ndang na hansitan.  
Ndang parsahiton,  
ndang adong  
parsirangan,  
ndang adong  
pananomom.  
Sasude na di  
Surgo marlas  
roha na  
manongtong  
rap dohot  
Debata.



Apala na dumenggan sian sude, ia adong pe Surgo i ima asa boi masuk tusi angka baa dohot boruboru na porsea di Jesus Kristus, Sipalua, jala mangoloi Ibana gabe Tuhan nasida. Di Banua Ginjang adong do buku na ginoaran Buku Hangoluan ni Birubiru. Gok do disi goar ni jolma. Diboto ho do angka goar ni ise tarsurat disi? Sude jolma na porsea di Jesus. Adong do goarMu disi?

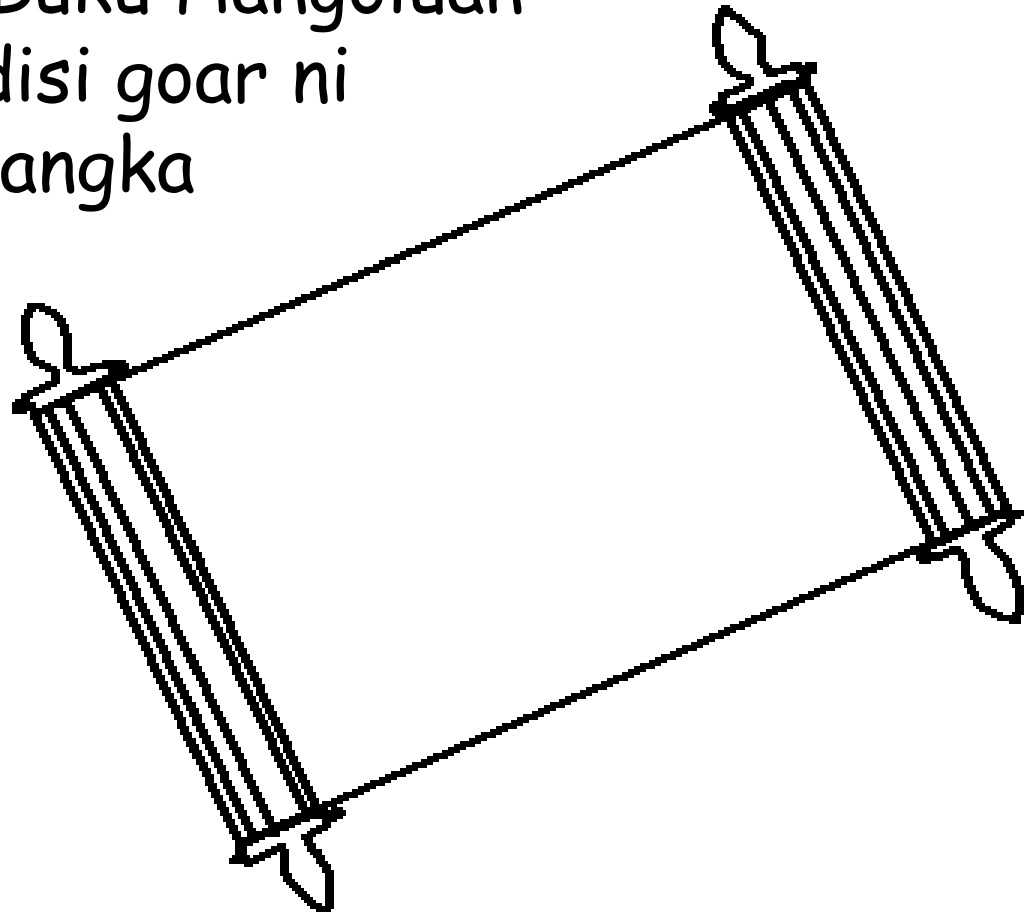

Hata na parpudi di Bibel taringot tu Surgo, ima  
gokhon na mansai uli. "Jadi didok Tondi dohot  
oroan i ma: Ro ma Ho! Laos dohonon ni na  
umbegesa: Ro ma ho! Sai ro ma na mauas; dijalo ma  
giot roha i ma aek hangoluan i, dalam basabasa!"

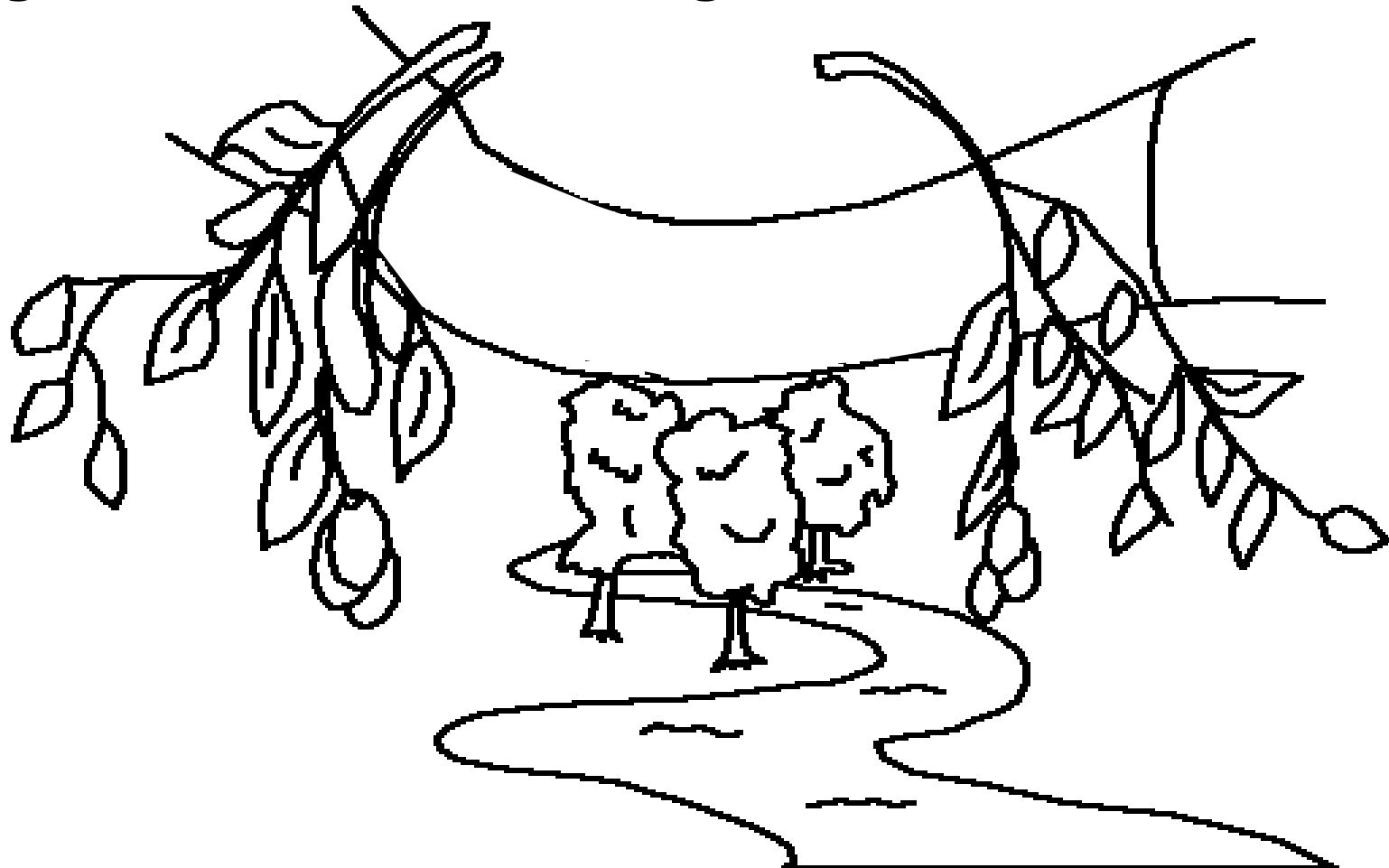

Banua Ginjang (Surgo), Huta Nauli ni Debata

Dapot do sada barita sian hata ni Debata,

ima Bibel,

Johannes 14, 2 Korint 5,  
Pangungkapon 4, 21, 22

"Pangungkapon di angka hataMi do patiur  
parnidaan." Psalmen 119:130



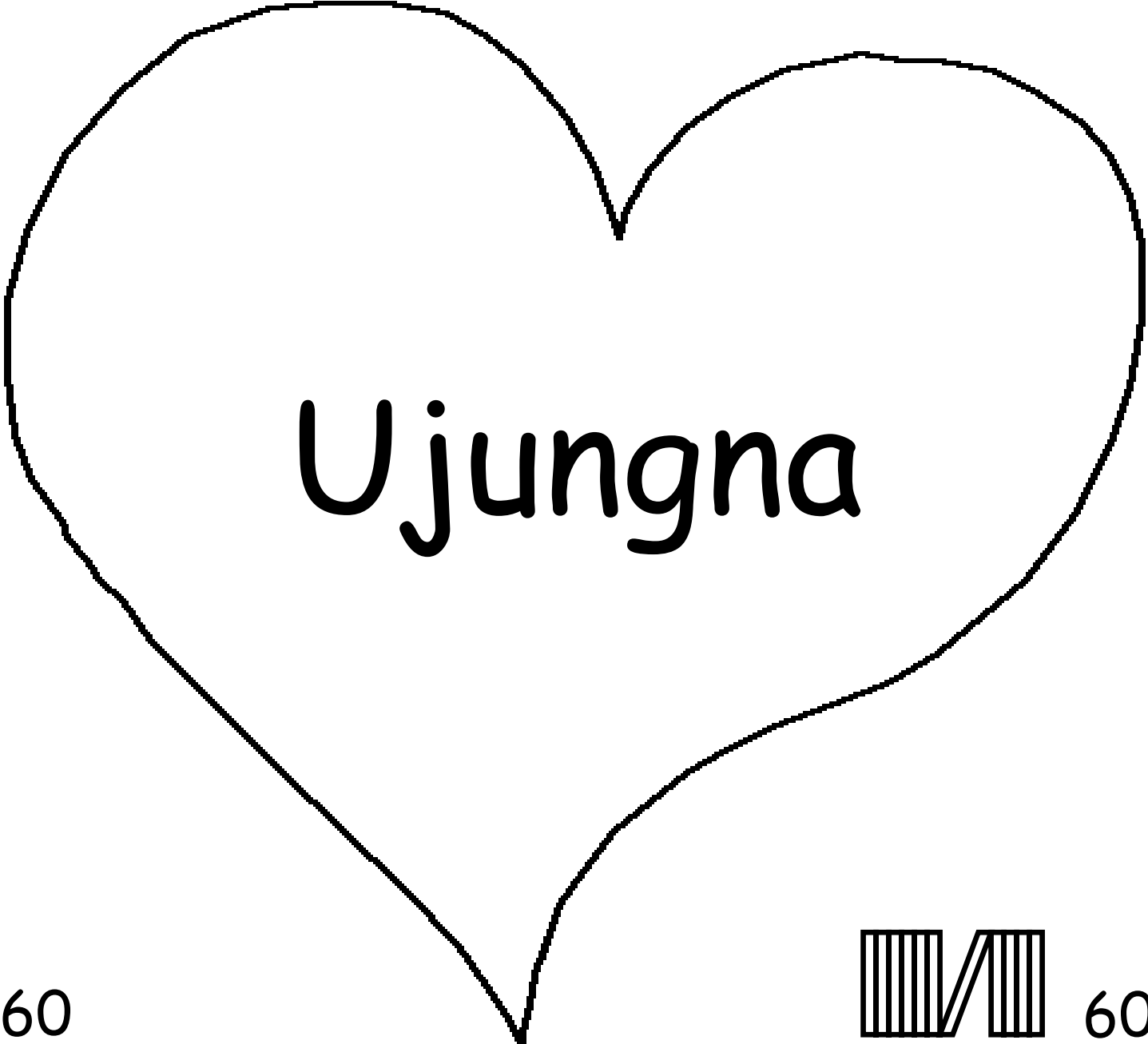

60

60



Dipabotohon Carita Bibel on tu hita taringot tu Debata na sun hinagogo, na manompa jala na manghasiholi ho asa mananda Ibana.

Diboto Debata do naung taulahon angka na roa, i ma dosa. Hamatean do uhum ni dosa, alai mansai holong do roha ni Debata di Ho, i do umbahen na ditongos AnakNa na sasada i, Jesus. Nunga mate tarsilang jala hona uhum Ibana ala ni dosam. Dung i mulak mangolu ma Ibana, jala mulak muse tu Banua Gintang! Molo porsea ho di Jesus jala dipangido roham asa disesa dosam, sai na patupaonNa do i! Ro do Ibana jala mian di bagasan ho saonari, dung i mangolu ma ho rap dohot Ibana ro di salelengna.

Molo porsea do ho di hasintongan on, dok ma songon on tu Debata:  
O Jesus, porsea do ahu na Debata do Ho, jala naung gabe jolma.  
Naung mate do Ho ala ni dosangku, alai nuaeng mulak mangolu do Ho.  
Ro ma Ho tu ngolungku jala sesa ma dosangku, asa dapot ahu ngolu na imbaru, jala molo ro tingkina, gabe rap ahu dohot Ho ro di salelengna.  
Urupi ma ahu mangoloi Ho jala mangolu di Ho songon anakhonMu.  
Amen.

Jaha ma Bibel i jala manghatai ma ho dohot Debata ganup ari!  
Johannes 3:16

