

Al-Kitab untu' Ana'-ana' Memperssembahkan

Suruga, Bolana Allataala iya makessingngé

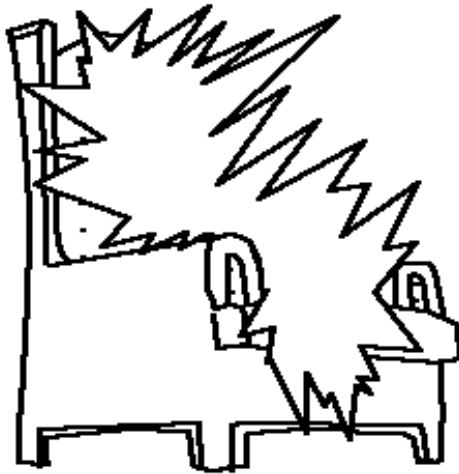

Parokina Iyanaritu: Edward Hughes
Pa'gambarana iyanaritu: Lazarus

Penterjemana iyanaritu: Armin Sukri
Pengadaptasinna iyanaritu: Sarah S.

Curita 60 polé ri 60 nomoro

www.M1914.org

Bible for Children, PO Box 3, Winnipeg, MB R3C 2G1 Canada
Ijin: Weedimmua rilemba iyaré curitaé iyakiya de' nawedding ri balu'.

Bugis

Riwettunna Isa tuwo ri linoé napowadai lao ri ana'-ana' gurunNa passalengna suruga. Aléna naseng "Bolana Ambo'ku," makkedai maéga bola kuwaro. Bola iya maloppoé natemmaka makessinna. Suruga iyanaritu onrong iya temmaka kessinna na onrong laingngé iya engkaé ri suruga.



1

Makkeda Isa, "Maéloka lao passadiangekko onrong. Narilaoku passadia onrong, maéloka lisu paimeng untu' tarimako." Isa Al-Masih lisu paimeng ri suruga purana tuwo paimeng. Wettuna naita ana'-ana' gurunNa, menré'ni Isa risalémuri ellung gangkanna lennye' polé ripakkitanna mennang.



2

Mappammula kuwaro, sininna umma' Kristen marénggerangngi makkeda Isa maéloi lisu paimeng untu' tiwi manengngi ri onronNa. Isa makkeda maéloi lisu matti. Iyakiya pekkugiwi rékko matéki ridénapa nalisu Isa? Kitta'é napoadai makkeda, laoi mennang sibawa Isa. Maté sicara jasmani iyakiya tuwoi

sibawa Puangngé.

3

Wahyu, kitta' paccappureng rilaleng Al-kitab, powadangngi temmaka kessinna onrong riasengngé suruga. Passaleng iya kaminang makessingngé iyanaritu suruga bolaNa Allataala. Allataala engkai kega-kega muwa, iyakiya onronNa iyanaritu ri suruga.

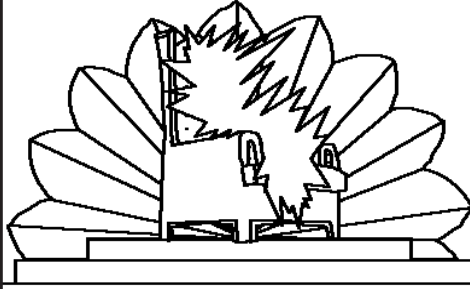

4

Malaika' sibawa séuwaé ri suruga nasompawi Puang Allataala ri suruga. Sininna tau matepe'é iya matéwé lao ri suruga. Makkélongngi pojiwi Allataala.

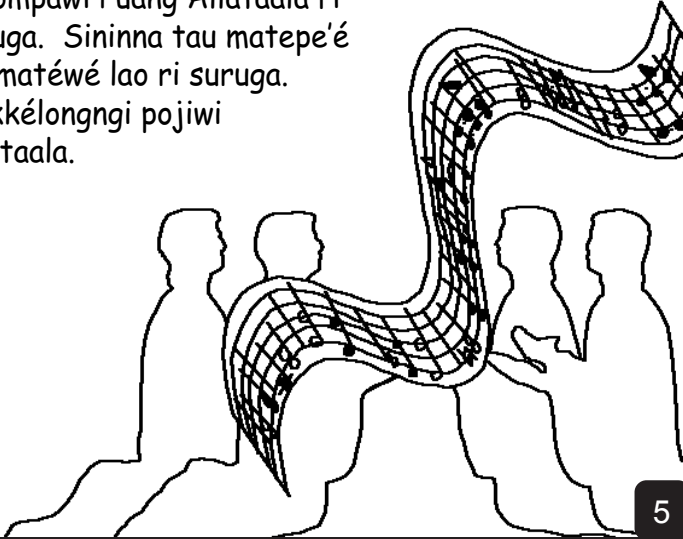

5

Kuwaré engka ada-ada polé ri élonna: MAPACCIKKI' PUANG NASABA' ALETA PURAKI' MUPALEPPE' POLE RIDOSAE NAOLAI DARAMU RISININNA SUKU, BANGSAE, SIBAWA MUPANCAJIKI' RAJA SIBAWA IMANG LAO RI IDI' PUANG. (Wahyu 5:9)

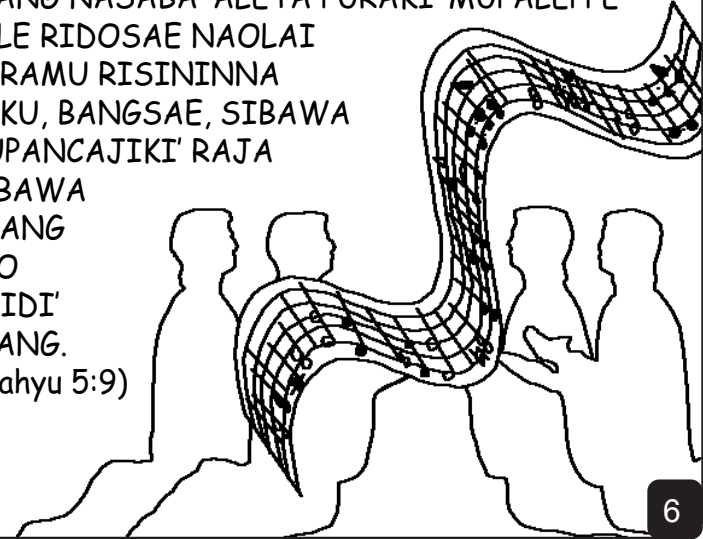

6

Ripaccappurena kitta'é suruga riasengtoi "Yerusalem baru". Temmaka loppona nakelilingi sappo loppo saliwenna. Sappo batu Jasper, mapaccing pada-pada Kristal.

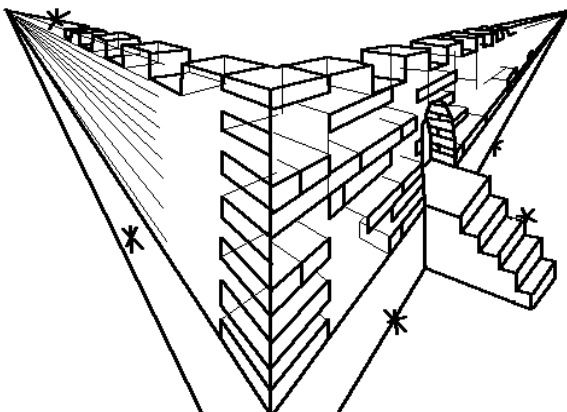

7

Permata sibawa batu-batu berharga mancajiwi pondasi iyaro sappoé, mattappa makkarupa-rupang. Tungke'-tungke' tange' gerbanna riabbu polé ri mutiara loppo.

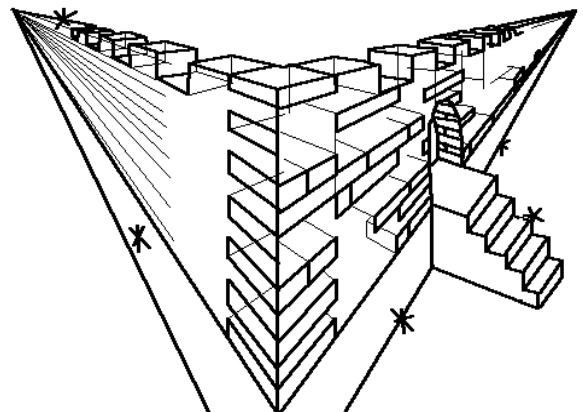

8

Iyaro tange' gerbanggé de' naengka natassampo. Tama'ni makkita-kita...WOW! Temmaka kessinna surugaé. Iyaro kotaé riyabbui polé ulaweng pada-pada kaca, tattanaéto riyabbu polé ulaweng.



9

Temmaka kessinna, salo mapaccing massolo' polé ri tudangenna Allataala. Engkato pong aju atuwong, iya engkaé ri dare' Eden ri pammula-mulanna. Iyaré pon ajué temmaka kessinna. Engka seppuladuwa rupanna buwa ri batanna, laing tungke'-tungke' uleng. Dau'-daunna iyanaritu pajjappana bangsa-bangsaé.

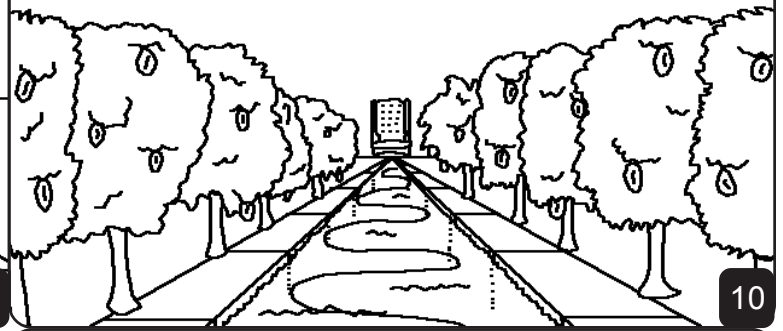

10

De'naparellu mataesso iyaréga kéteng ri suruga. Nasaba' kemuliaanNa Allataala cakkariwi. De'gaga wenni rionrongéro.

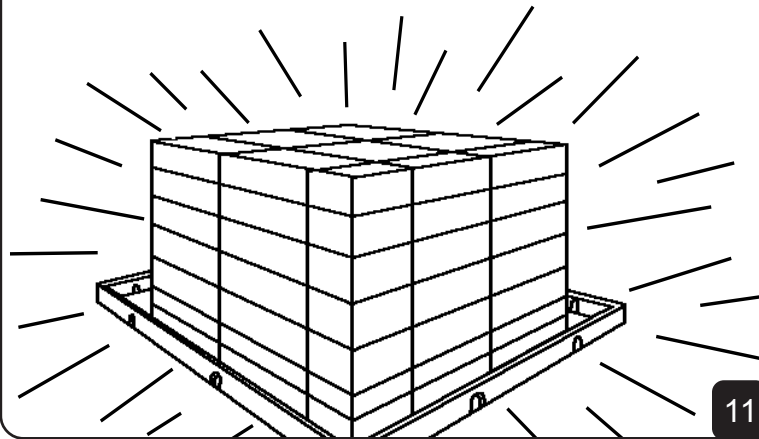

11

Olo-kolo' ri surugaé laing muto rupanna. Dé'gaga olo-kolo' maliya'. Asu ale' sibawa bémbala' manré wella massibawa. Namuni singaé manrétoi wella pada-pada sapingngé. Makkeda Puangngé, "Dé'gaga macilaka iyaréga mapeddi ri bulu' mapaccing-Ku."

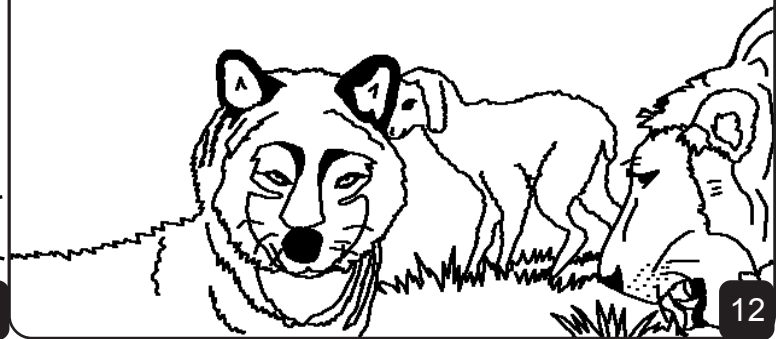

12

Narékkko makkitaki' risekelilitta, engka séddi de'gaga riruntu' ri Suruga. De'gaga ada-ada maja'riyangkalinga. De'gaga tau mallaga atau simmusu'.

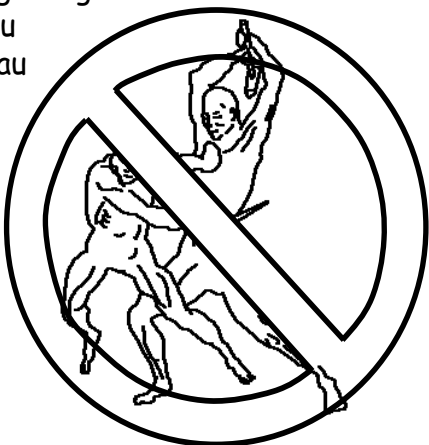

13

De'gaga goncing ri tange'é, nasaba' de'gaga panga ri suruga. De'gaga pa'bellé-bellé, pauno, sanro sehére, iyaréga tau maja sipa'. De'gaga dosa turunan ri suruga.



14

Dé'gaga uwai mata ri suruga.
Biasa tau mateppe'é kara'i
nasaba' anrasa-rasanna rilaleng
atuwonna. Ri suruga, Allataala
nasapu manengngi uwai mataé.



15

Dé'gaga amaténg risuruga. Tau mateppe'é engkai
tuwo mannengngeng ri suruga. De'gaga pessé na
anrasa-rasang, de'gaga
terri, de'gaga
peddi.



16

De'gaga lasa, pesta, iyaréga attampungeng.
Sininna engkaé ri suruga masennang manengngi
sibawa Allataala.



17

Iya madécénggé, suruga untu' worowané sibawa
makkunrai iya mateppe'é lao ri Isa Almasih
sélaku pappasalama'na sibawa
naturusiwi sélaku Puang.

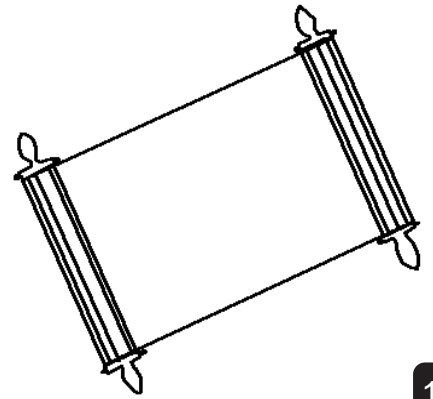

18

Ri suruga engka séddi bo'bo' riyaseng Bo'
Atuwong. Engka maéga aseng rilalenna.
Muwissengngiga niga aseng riyoki'
rilalenna? Sininna tau
iya mateppe'é lao
ri Isa. Engkaniga
asemmu kuwaro?

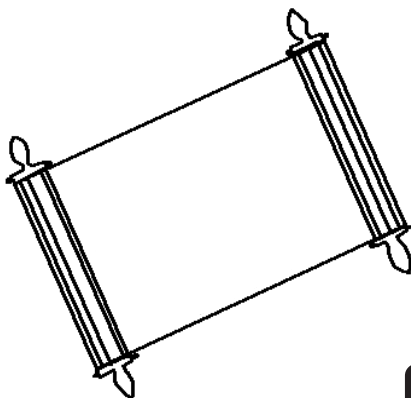

19

Ripaccappureнна kitta'é passalenna suruga engka
ada-ada iya kaminang makessingngé lao mobbi'ki'.



20

"Makkedani Roh Mapaccingnge sibawa bottinggé,
'Laoni maé!' Lappessani sininna maréngkalingaé
makkeda 'laoni Maé!'

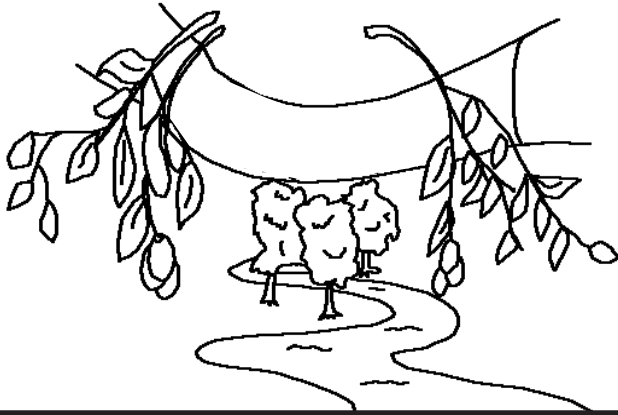

21

Lappessani tau madekkaé maddeppé. Sininna tau
parellué, lappessani tarima uwai atuwong sicara
cuma-cuma."

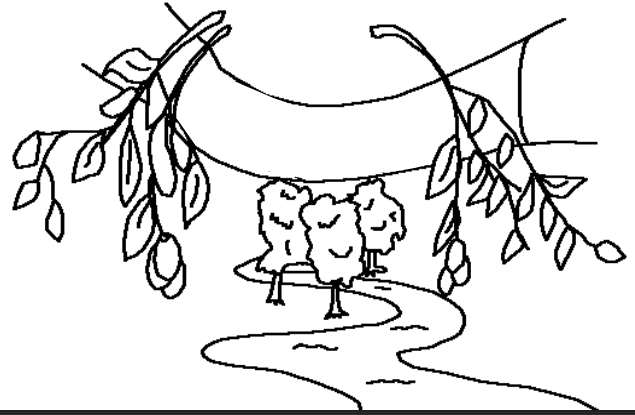

22

Suruga, Bolana Allataala iya makessinggé

Seddi curita polé riada-adanna Puang
Allataala, Al Kitab,

riruntu' rilaleng

Yohanes 14, 2 Korintus 5,
Wahyu 4, 21, 22

"Rekko ripakanessai, ma'bbérei tajang
pappaguruwam-Mu." Mazmur 119:130

Puangngé naissengngi makkeda purani ripogau' maja'é, iya
riyasenggé dosa. Pahukkungenna dosaé iyanaritu amaténg.

Iyakiya Puangngé makkumani namaséi ki' gangkana
nabbéréyangngi Ana' tungke'na, Isa, untu' maté ri aju salli'é
mpaja'l asalatta (dosata). Isa tuwoi paimeng sibawa réwe'l ri
suruga! Makkekkuwangngé naddampengiwi dosa-dosata
Puangngé.

Narétko maéloki' salaiwi dosata, mellauni' lao ri Puangngé: O
Puang, mateppe'ka makkéda Isa matéwi nasaba' aléku, iyakiya
tuwoi paimeng. Muttamani' ri atuwokku sibawa addampengiwi
dosa-dosaku, kuwammengngi utarimai atuwong mabarué
kowaétopa mannennungeng. Tulukka' tuwo sélaku ana'ta,
Amin. Yohanes 3:16

**Ribacawi kitta'é sibawa maddenuwangngi' lao
ri Puangngé esso-esso!**