

Bible for Children  
presents

# JONAH AND THE BIG FISH

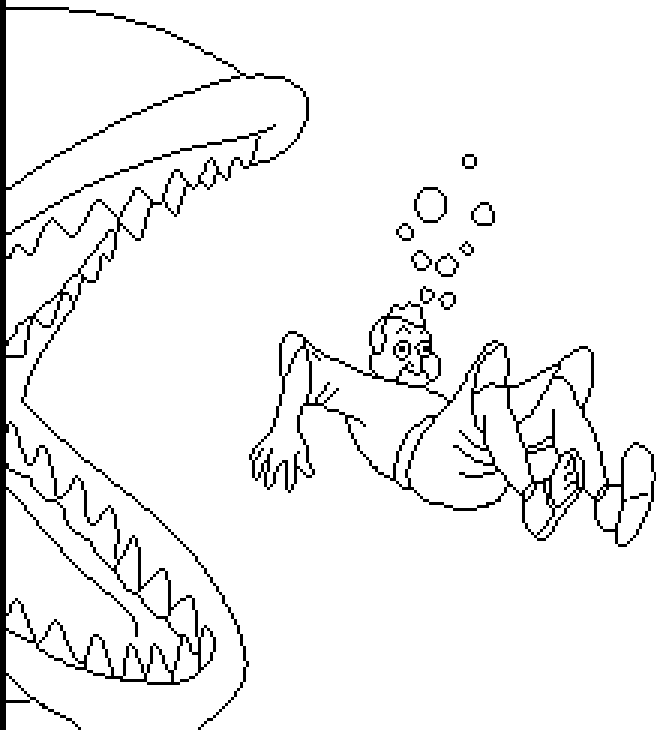

Written by: Edward Hughes  
Illustrated by: Jonathan Hay  
Adapted by: Mary-Anne S.  
Produced by: Bible for Children  
[www.M1914.org](http://www.M1914.org)

BFC  
PO Box 3  
Winnipeg, MB R3C 2G1  
Canada

©2007 Bible for Children, Inc.

License: You have the right to copy or print this story,  
as long as you do not sell it.



Many years ago, a man named Jonah lived in the land of Israel. One day, God told him to go to Nineveh, the biggest, most powerful city in the world.

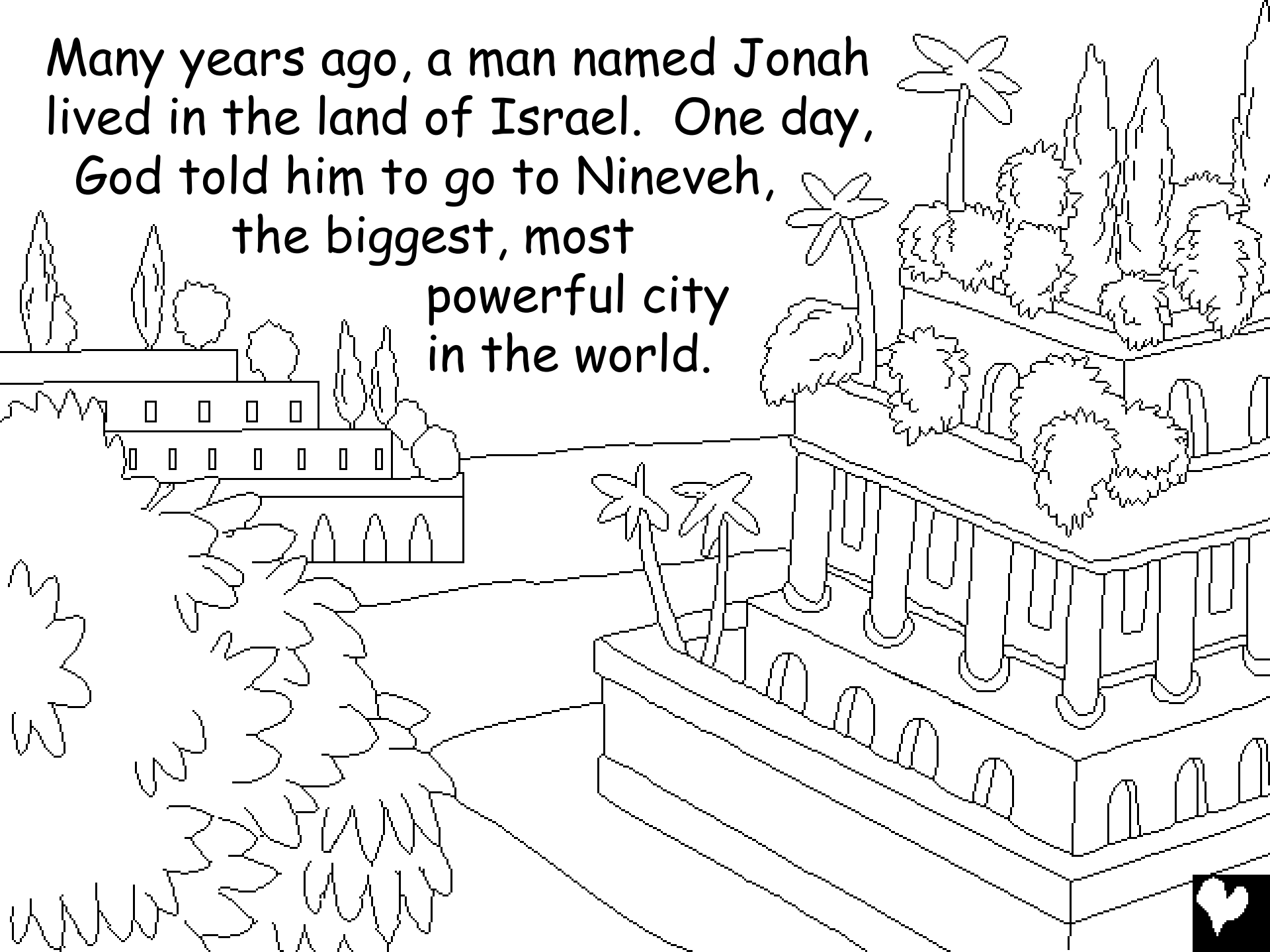

Jonah was to warn all the people there that God knew how wicked they were.

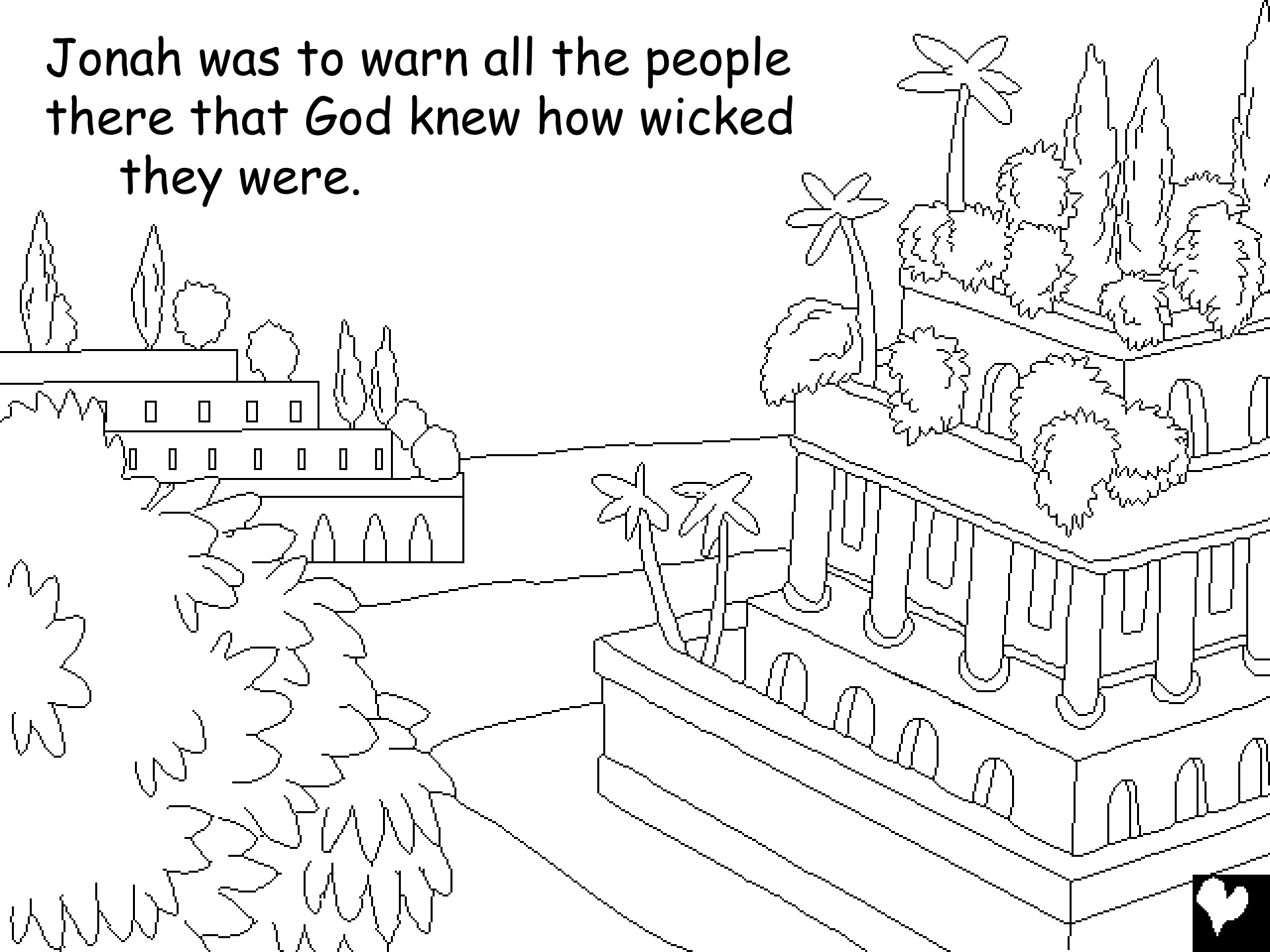

Jonah disobeyed God! Instead of going to Nineveh, Jonah got onto a ship and sailed away in the opposite direction to a place called Tarshish.

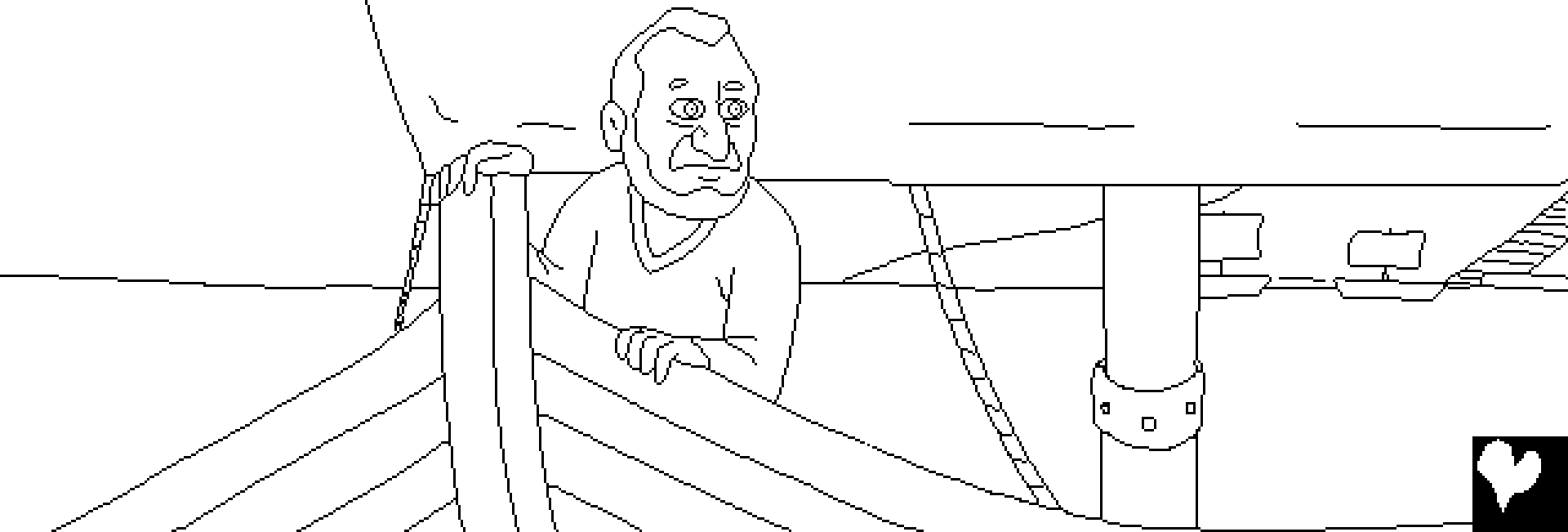

The LORD God sent out a great wind into the sea.  
There was a huge storm! The sailors feared the  
ship might break apart and sink.

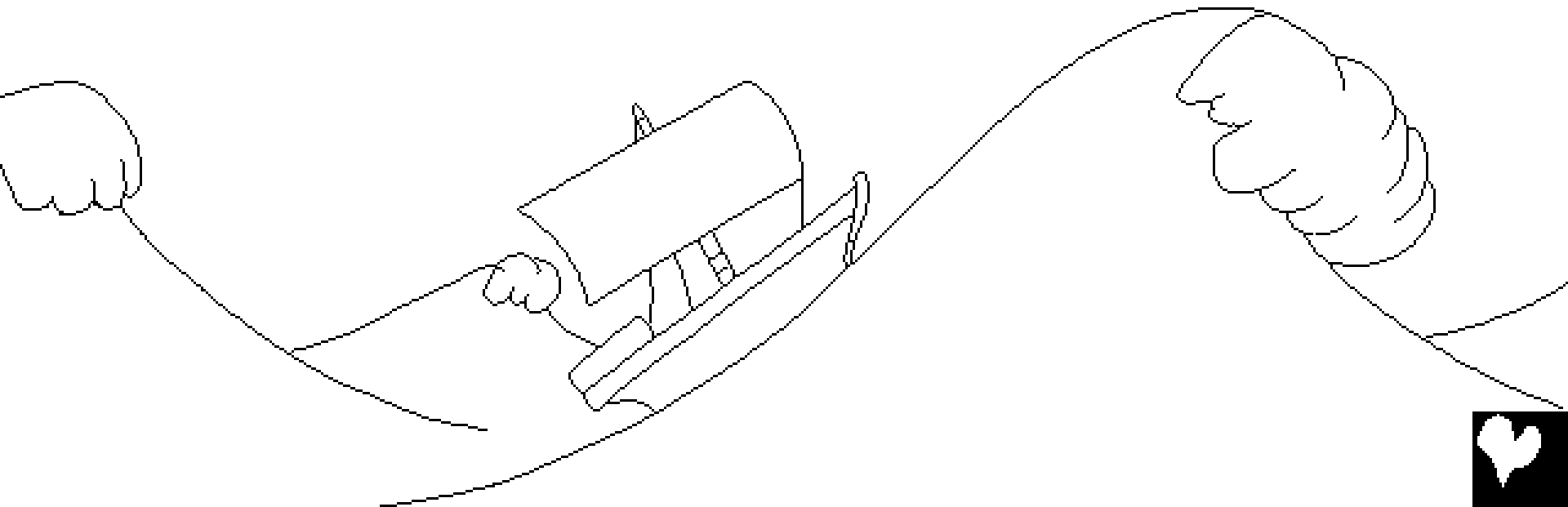

The storm got worse and worse. Terrified, the sailors prayed to their gods and threw all the cargo overboard to lighten the ship. But nothing helped.

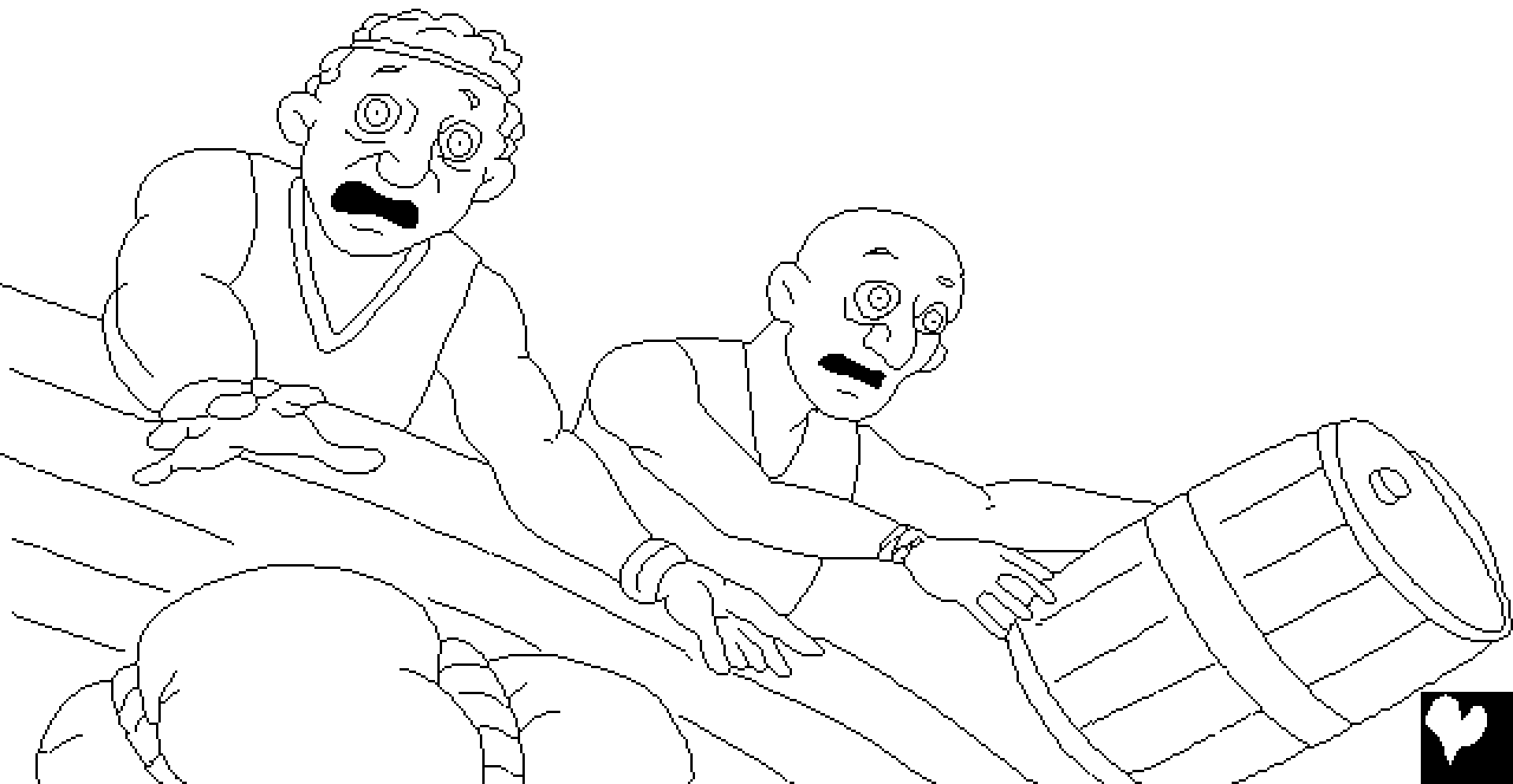

Jonah was the only person on board who wasn't praying. Instead, he was lying down inside the ship, sound asleep.

The ship's captain found him. "What are you doing sleeping? Get up! Say a prayer to your God! Maybe God will think of us, so that we will not be destroyed."





The sailors soon decided that their trouble had something to do with Jonah. He told them that he was running away from the LORD. They asked, "What should we do to you, so that the sea may become calm for us?" "Pick me up and throw me into the sea," Jonah replied.

"For I am certain that because of me this great storm has come on you."



The sailors didn't want to throw Jonah overboard. So they rowed hard to bring the ship to land. But they couldn't. There was only one thing to do!

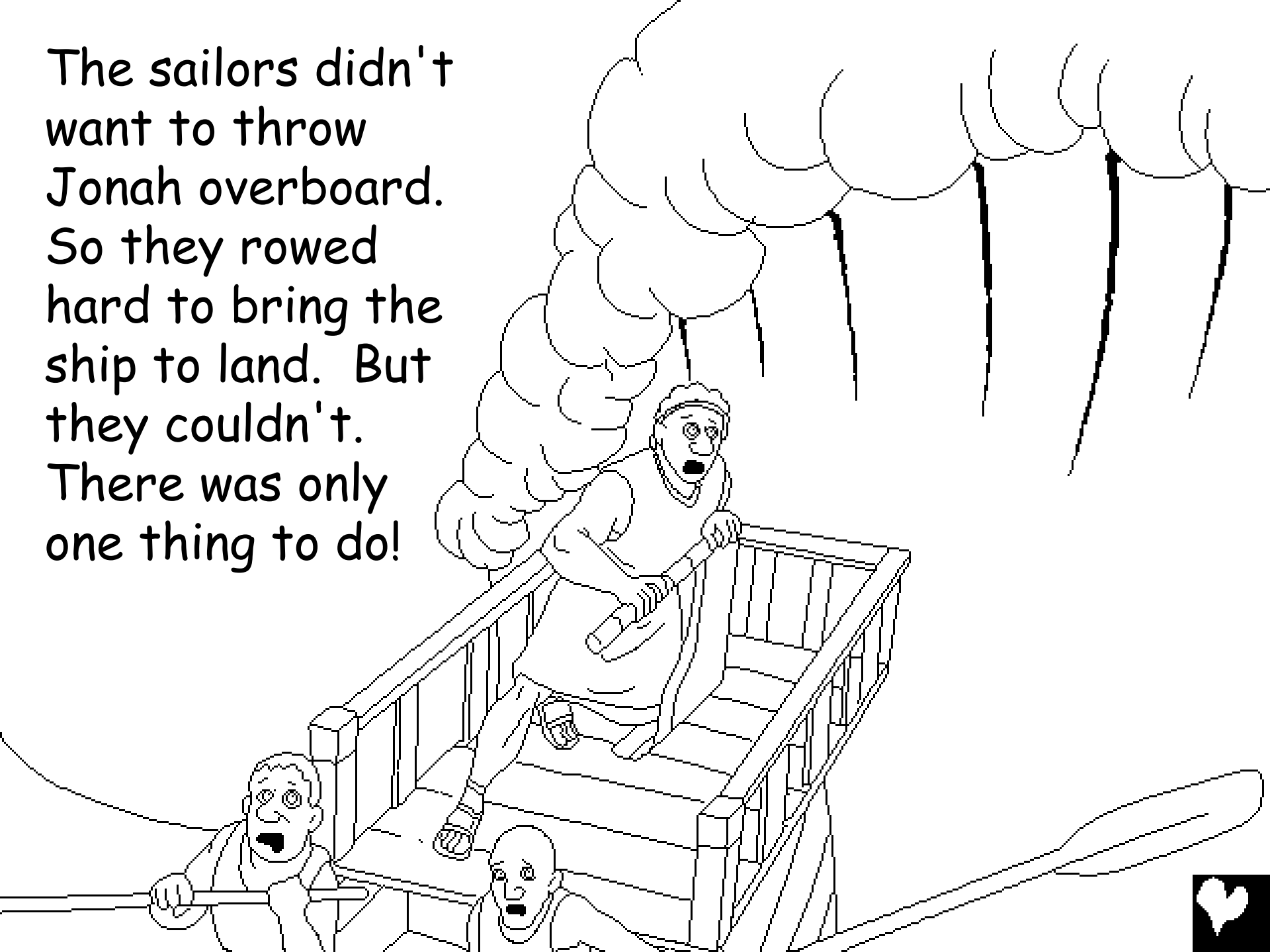

After praying for forgiveness, the sailors lifted Jonah up and tossed him over the side.

As Jonah disappeared below the waves, the sea became still and the wind died down. The sudden change in the weather scared the sailors more than the storm did. They must have known only God could do that. In fear and wonder, they worshiped the LORD.

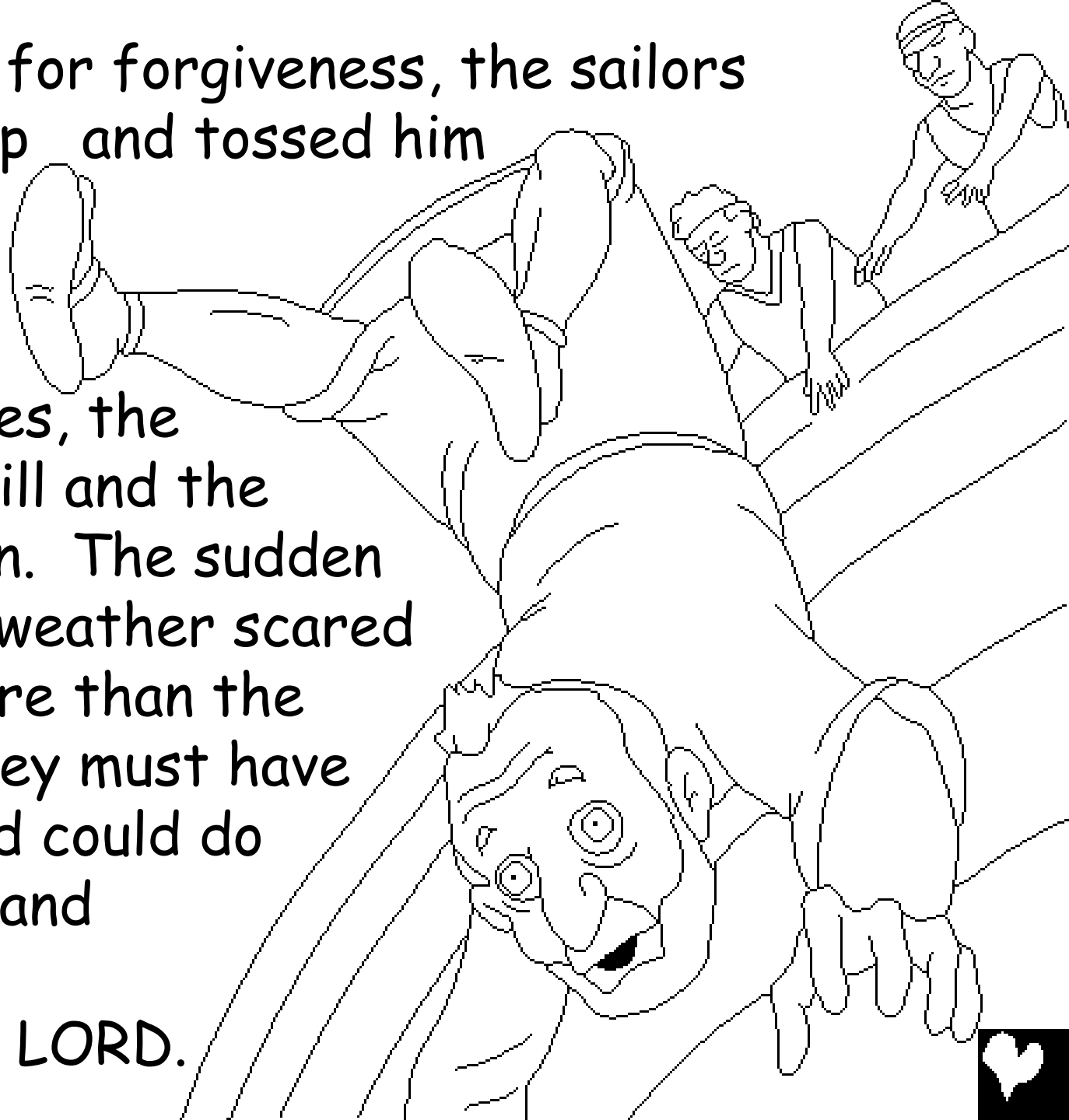

Meanwhile, the disobedient messenger got a big surprise. Helplessly sinking in the depths of the sea, Jonah knew nothing could save him from drowning. He would have drowned, too — but God had other plans.

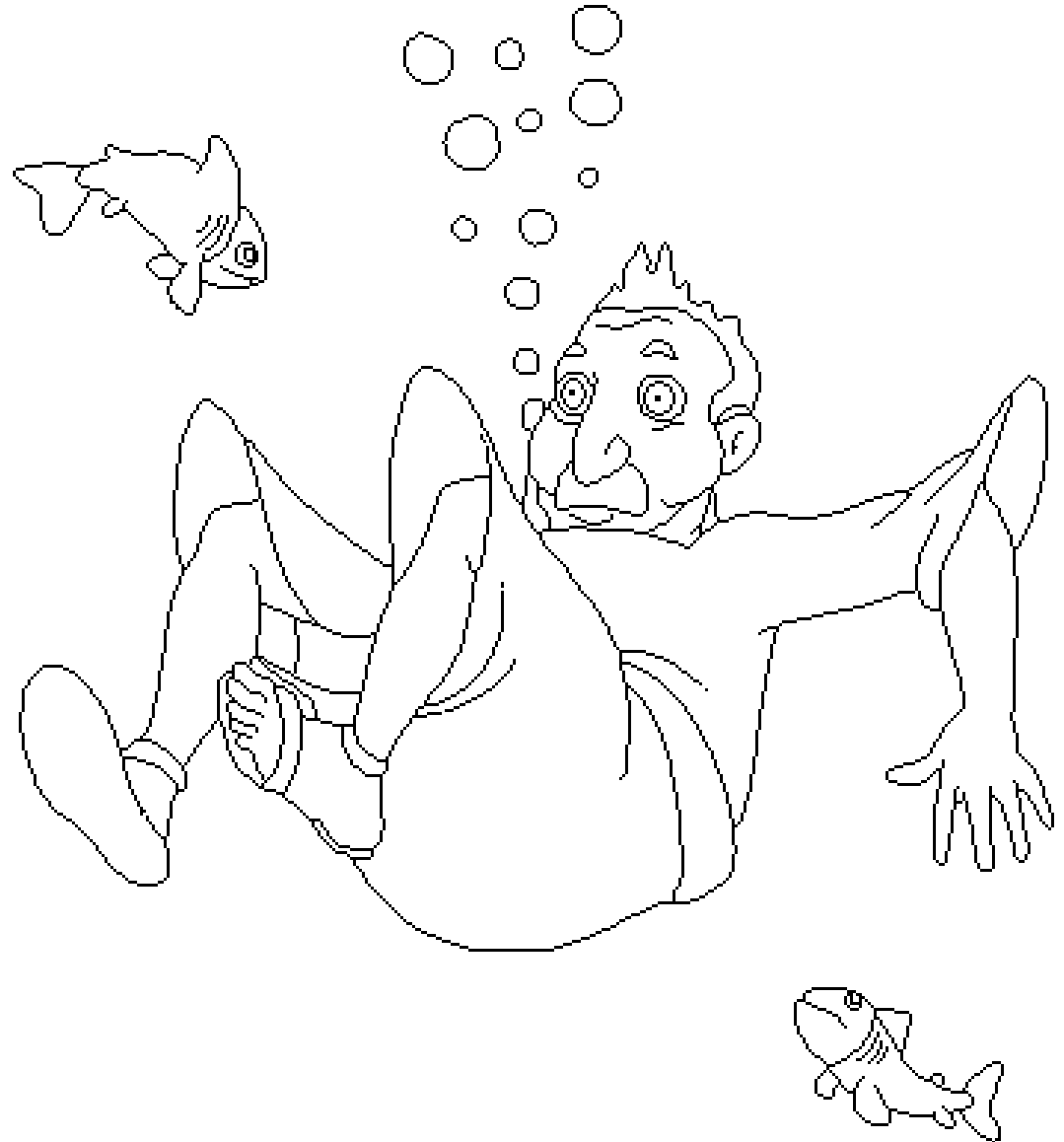

The LORD had prepared a big fish to swallow up Jonah. The fish was right on time! One gulp and Jonah was out of the sea and into the fish's belly. Jonah stayed inside the fish for three days. He had lots of time to think and pray.

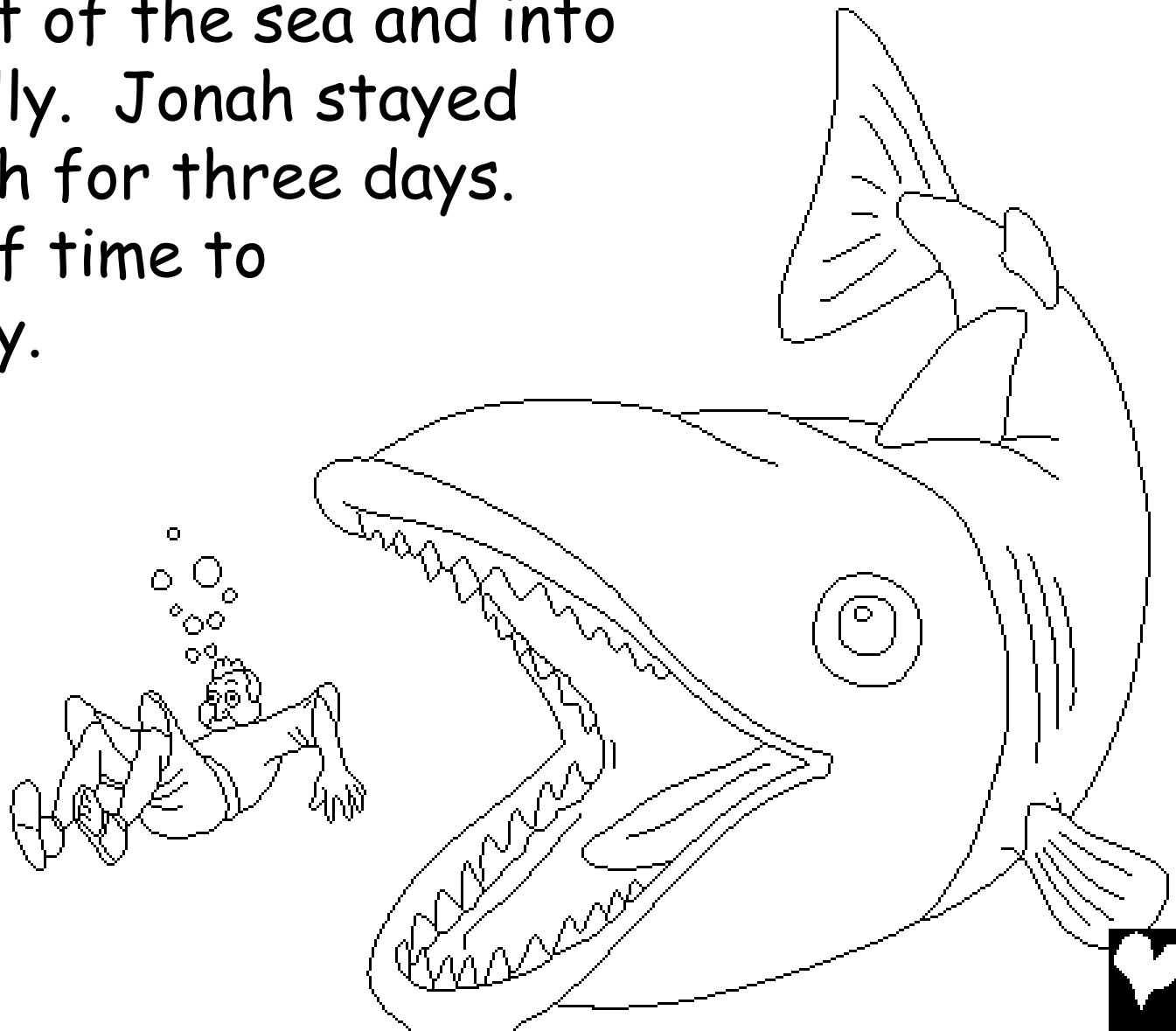

Three days later, Jonah finally promised to obey God. Right away, God spoke to the fish, and it vomited Jonah on to the beach.

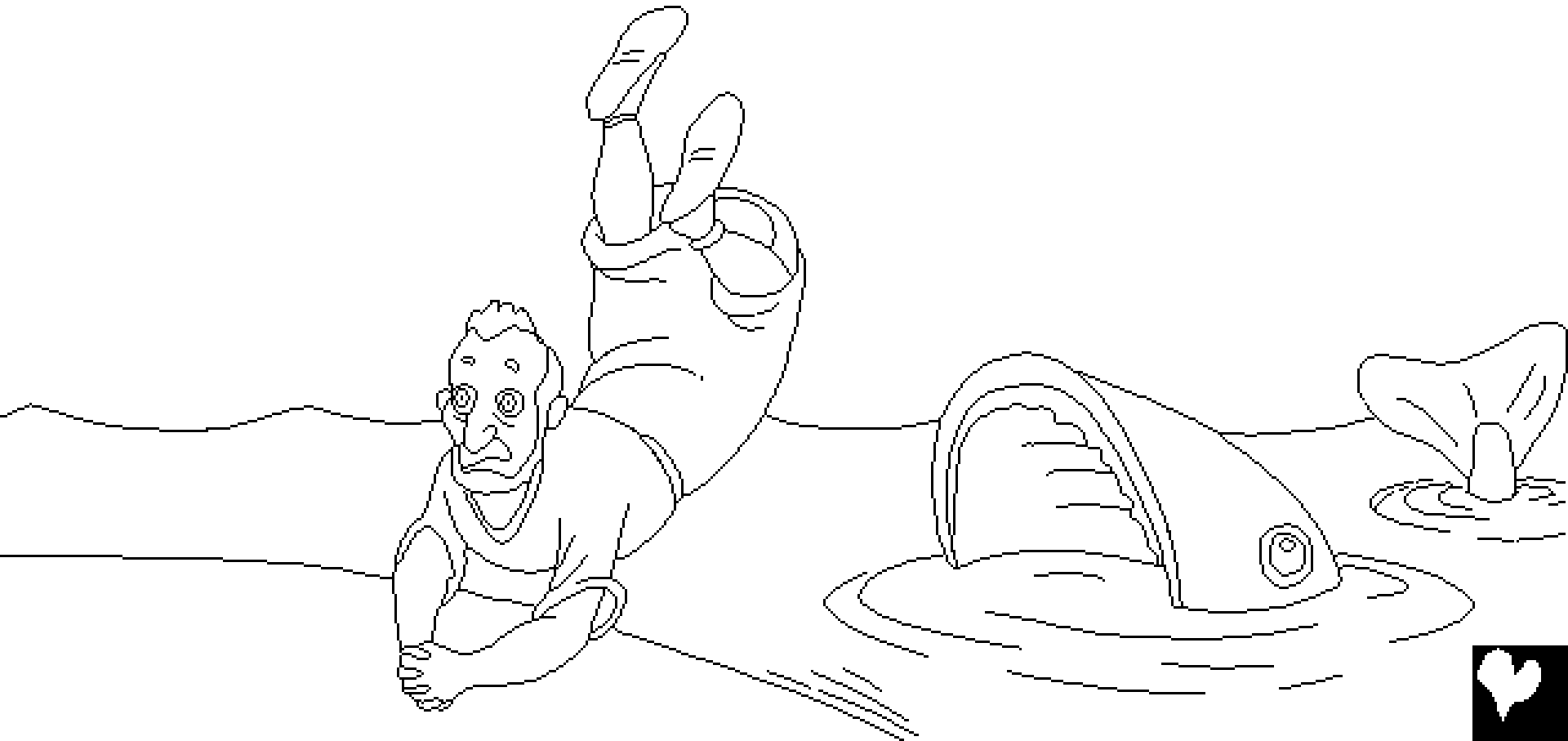

Once again, God told Jonah to go to Nineveh and preach God's word. This time, Jonah went! Jonah entered the city, shouting, "In forty days, Nineveh will be overthrown."



The people of Nineveh believed God's word. They went without food, and wore sackcloth to show God they were sorry for their sins. Even the king humbled himself before God. He got off his throne, put on sackcloth, and sat in ashes. He commanded everyone to turn from their wicked ways and violence, and to pray that the LORD would forgive them.





God DID forgive them! It must have been a wonderful day of joy in Nineveh when the people realized that God had forgiven them.

... But one person was very angry.  
Jonah!



Why was Jonah angry? He told God, "I knew that you are a gracious God, and merciful, slow to anger, and great in kindness." In other words, Jonah knew that God always forgives those who are sorry for their sins and obey God's Word. It seems that Jonah didn't like the people of Nineveh. He didn't want them to be forgiven.



Jonah was so angry with God that he said, "Take my life from me; for death is better for me than life."



Jonah sat outside the city, waiting to see what God would do next. The LORD God prepared a vine with big leaves. It grew quickly, and shaded Jonah from the hot sun all day.



The next morning, God sent a worm, which killed the plant. Then, the LORD prepared a hot, strong wind that blasted Jonah until he thought he would die. All of this made Jonah even angrier.



Then the LORD said to Jonah, "Have you any right to be angry? You had pity on the vine, for which you did no work and which you did not grow. It came up in a night and died in a night.

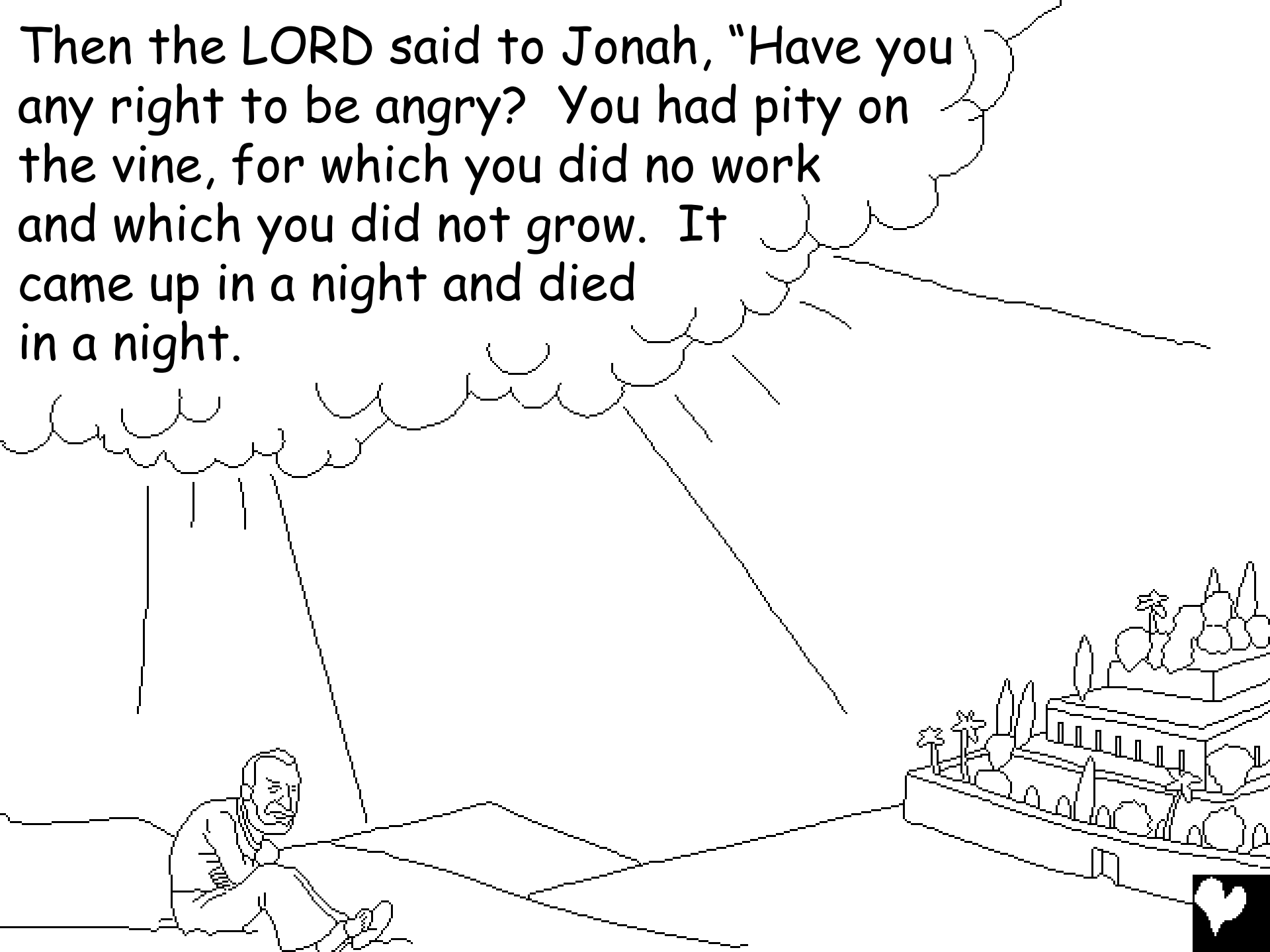

Why should I not have mercy on Nineveh, that great city, with its thousands of people?"



# Jonah and the Big Fish

A story from God's Word, the Bible,

is found in

Jonah

"The entrance of Your Words gives light."

Psalm 119:130





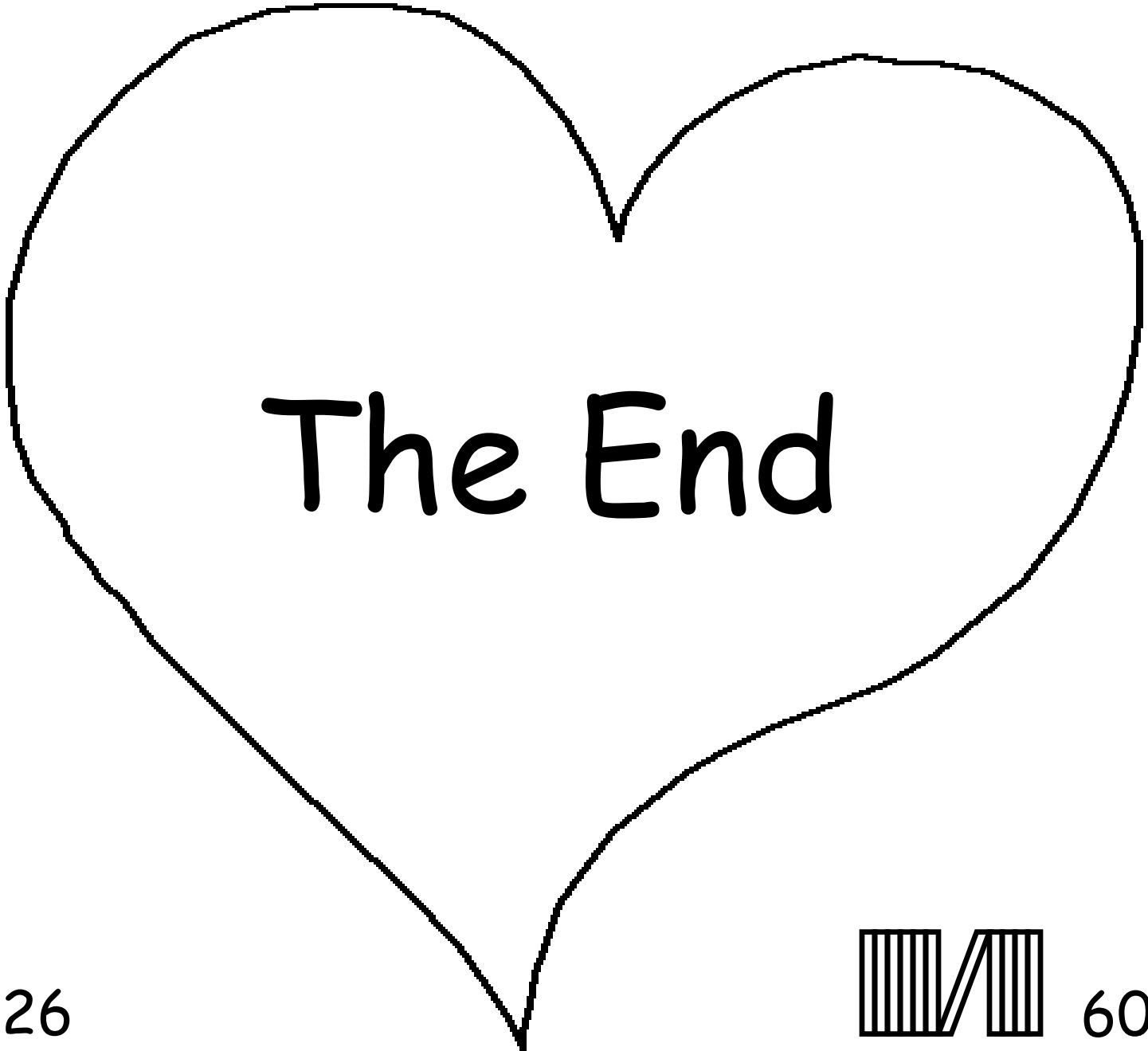

The End



This Bible story tells us about our wonderful God who made us and who wants us to know Him.

God knows we have done bad things, which He calls sin.

The punishment for sin is death, but God loves us so much He sent His Son, Jesus, to die on a Cross and be punished for our sins. Then Jesus came back to life and went home to Heaven! If you believe in Jesus and ask Him to forgive your sins, He will do it! He will come and live in you now, and you will live with Him forever.

If you want to turn from your sins, say this to God:

Dear God, I believe that Jesus died for me and now lives again. Please come into my life and forgive my sins, so that I can have new life now, and one day go to be with You forever. Help me to live for You as Your child. Amen.

Read the Bible and talk with God every day! John 3:16

