

Bibel fa Kjinja

brinjt junt

Samuel, Een
Jung dee Gott
deend



Jeschräwen von: Edward Hughes
Jemolt von: Janie Forest
Toom Pauss jestalt von: Lyn Doerksen
Äwasat von: Ed Zacharias
Hääjestalt von: Bible for Children
www.M1914.org

BFC
PO Box 3
Winnipeg, MB R3C 2G1
Canada

©2011 Bible for Children, Inc.

Jesazlich: Du doascht dise Jeschicht oppnämen ooda drekjen,
soo lang aus du dee nich vekjafst.



De Fru, Hana, un äa Maun, Elkana wieren goode
Menschen. See jleewden aun Gott un wieren
äare Nobasch goot. Oba Hana fäld
daut, daut see kjeen

Bäbe haud. See

luad, un see bäd un
hopt, un luad noch
mea. Doa wieren
kjeene Kjinja.

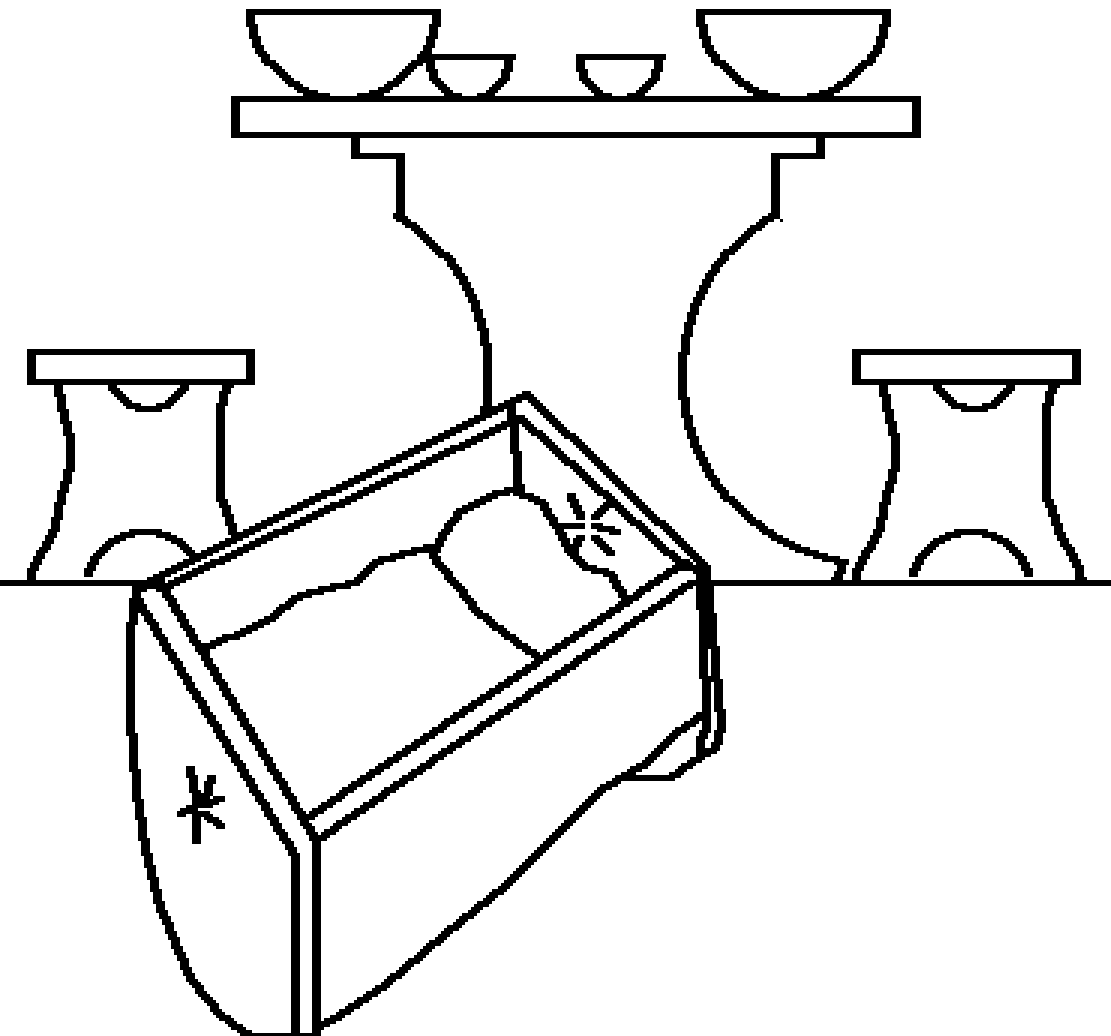

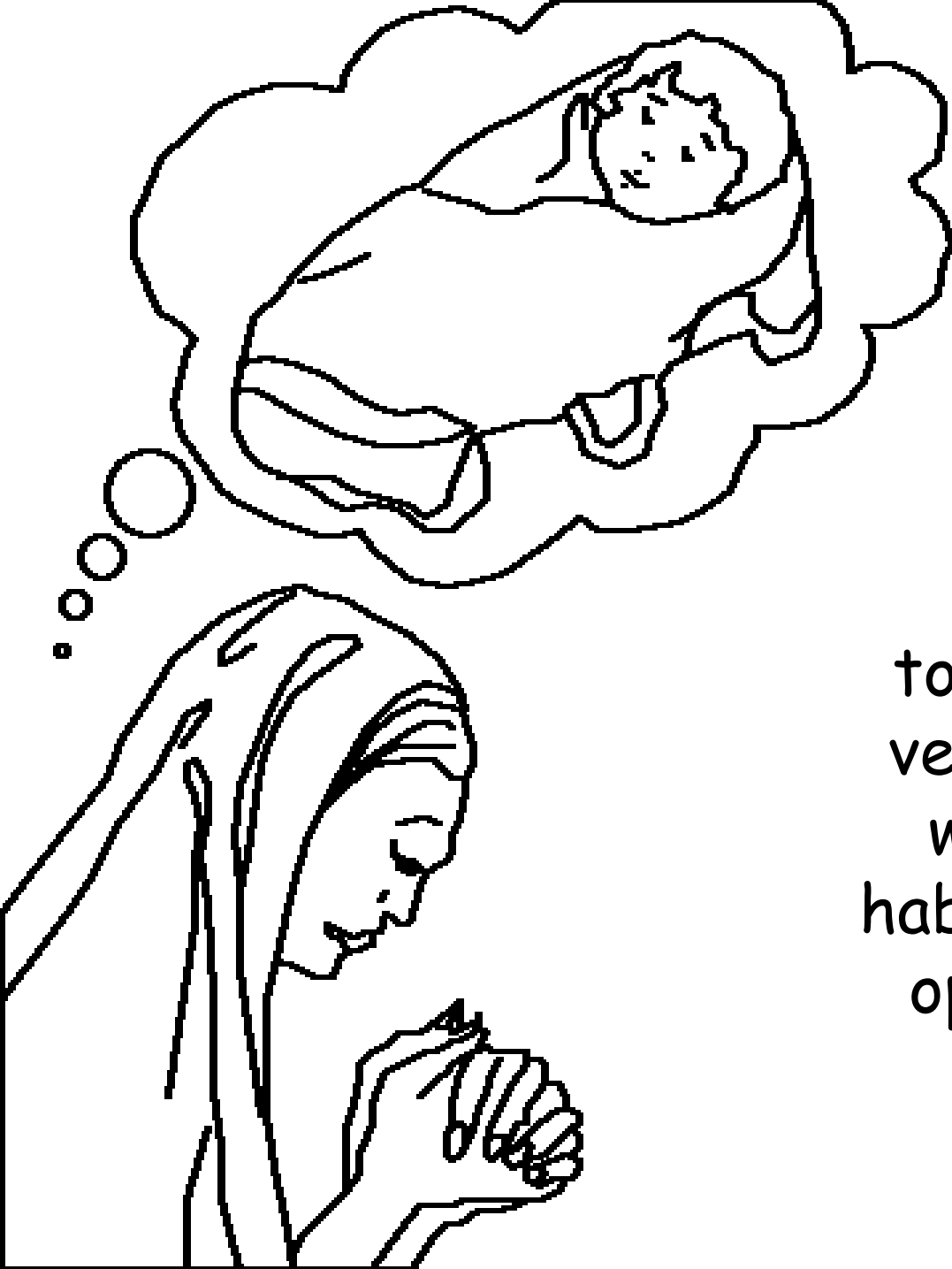

Jieda Joa jinkj Hana
nom Vesaumlungs-zelt
toom aunbäden. Eenmol
vespruak see Gott, daut
wan see kunn een Bäbe
haben wudd see am loten
opp emma Gott deenen.



De oola Priesta Eli
sach Hana bäden.
Hee docht see wia
besopen wiels äare
Leppen rieeden,
oba see säd
nuscht. Eli
schull Hana.





Oba Hana säd
Eli daut see fa
een Sän jebät
haud un waut see
vesproaken haud. Dan
säd Eli, "Go en Fräd.
Mucht Israel äa Gott
die daut jäwen om
waut du jebät hast."
Nu haud Hana Hopninj.



Nu kunn Hana sikj freien; un met de Tiet hauden see eenen Sän. See jeef am dän Nomen Samuel, wiels, soo säd see, ekj hab däm Harn doano jefroacht. Wudd Hana emdenkj hoolen waut see Gott vesproaken haud?

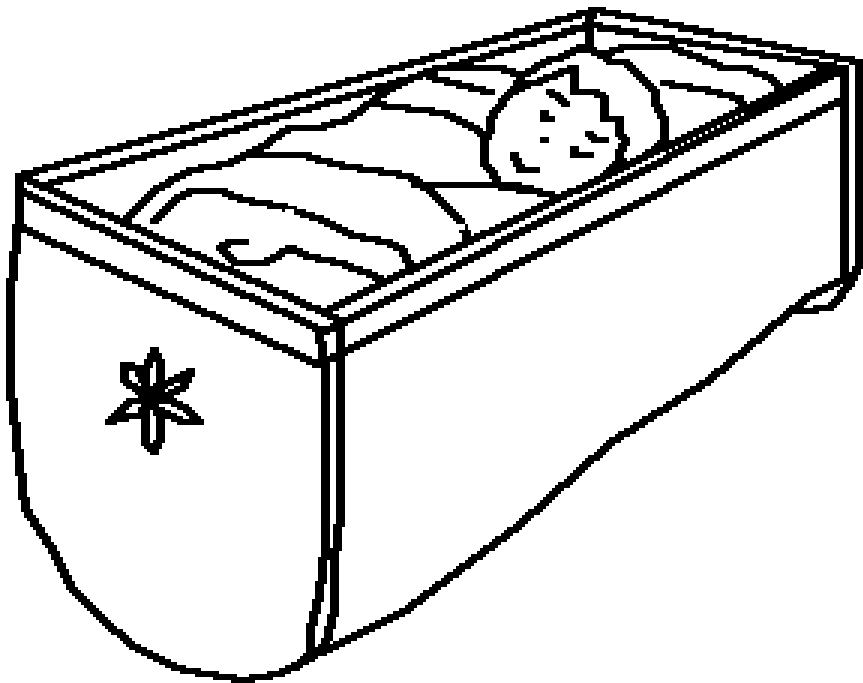



Daut näakjste Joa
jinkj Hana nich nom
Vesaumlungs-zelt.
Haud see äa
Vesprääkjen
vejäten? Nä,
Hana wull wachten
bat Samuel groot
jenuach wia toom em
Vesaumlungs-zelt
wonen, un Eli halpen
Gott deenen. Dan
brocht see am doahan.





Gott ieed Hana
daut see soo tru
wia. Gott jeef
Hana noch dree
Junges un twee
Mejales. Jieda
Joa jinkj Hana no
daut Vesaumlungs-
zelt toom Gott
aunbäden - un
Samuel een nieet
Hamd brinjen.



Doa wieren noch aundre waut Eli
holpen. Hee haud twee Säns, Hofni
un Pinhas, waut doa schauften. See
deeden schlaachte Dinja waut nich
em Tempel jehieeden. Eli prachad
an see sullen bāta
doonen, oba see
horchten nich.
De Lied wisten
daut daut
orrajcht wia.



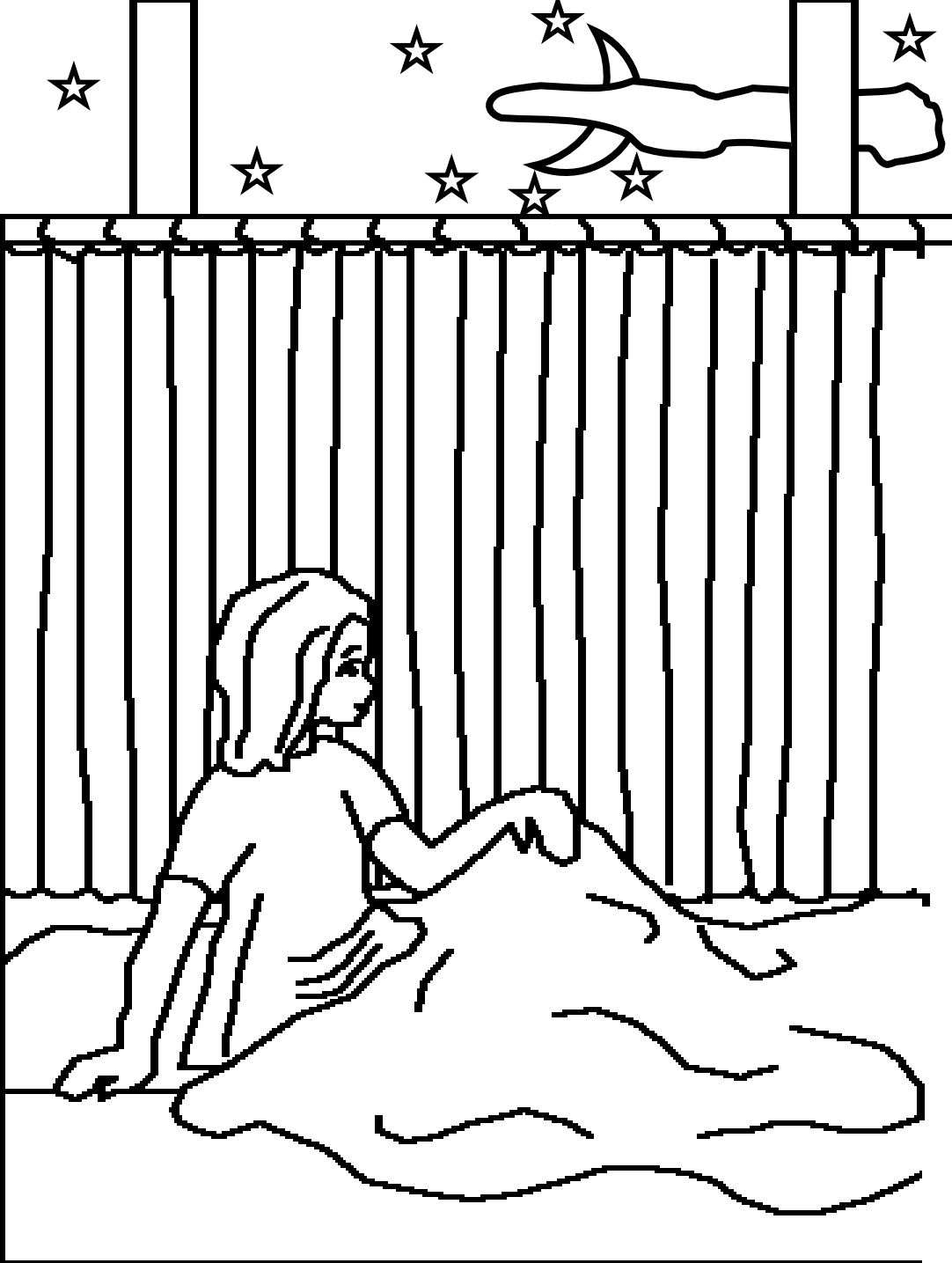

Eene Nacht hieed
Samuel eene
Stemm am roopen.
Hee docht daut wia
Eli, un hee jinkj no
am un säd, "Hia sie
ekj." "Ekj hab die
nich jeroopt," säd
Eli. Dit passieed
dree mol. Dan wist
Eli daut Gott
Samuel roopt.



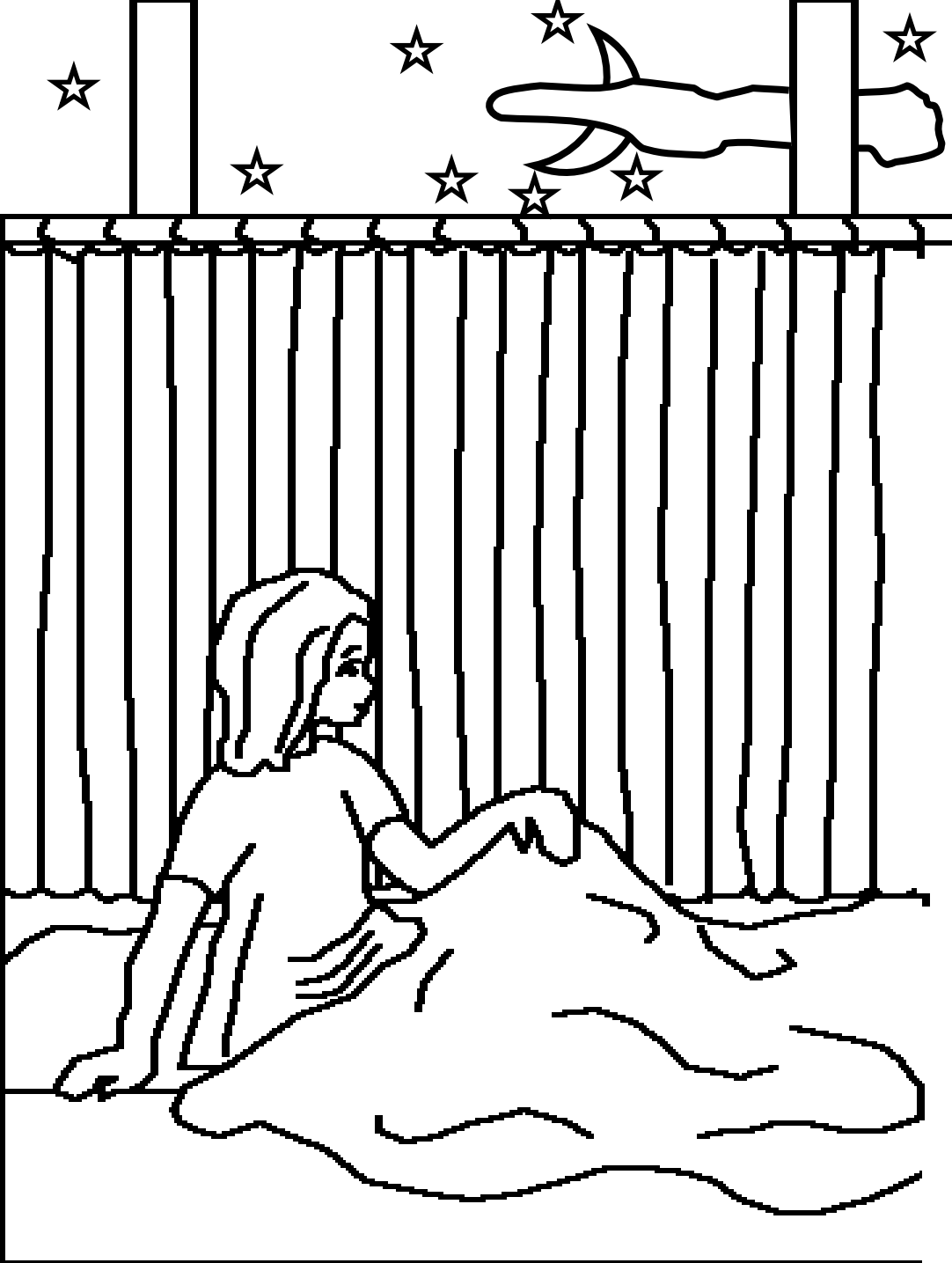

Eli säd, "Wan hee
wada roopt dan
saj, 'Räd Har,
dien Deena
horcht.'" Un
Gott roopt
noch wada un
jeef Samuel
eene wichtje
Norecht.



Zemorjes roopt Eli Samuel. Hee wull weeten waut de Har am jesajcht haud. Samuel säd am aules, wan daut uk waut schwoaret wia. Gott wudd Eli un siene Famielje ombrinjen wäajen Hofni un Pinhas soo schljacht wieren.



Waut Gott jesajcht haud, kjeem soo.
En eenen Kjrigh met de Filista,
druagen Hofni un Pinhas Gott siene
Kjist met de Israelitische Soldoten.
De Fient neem de Kjist, un
muaken Hofni un Pinhas
doot, un vâl Soldoten.
Aus Eli daut hieed, waut
jeworden wia, foll hee
von siene Benkj, bruak
sien Jenekj un
storf dän Dach.

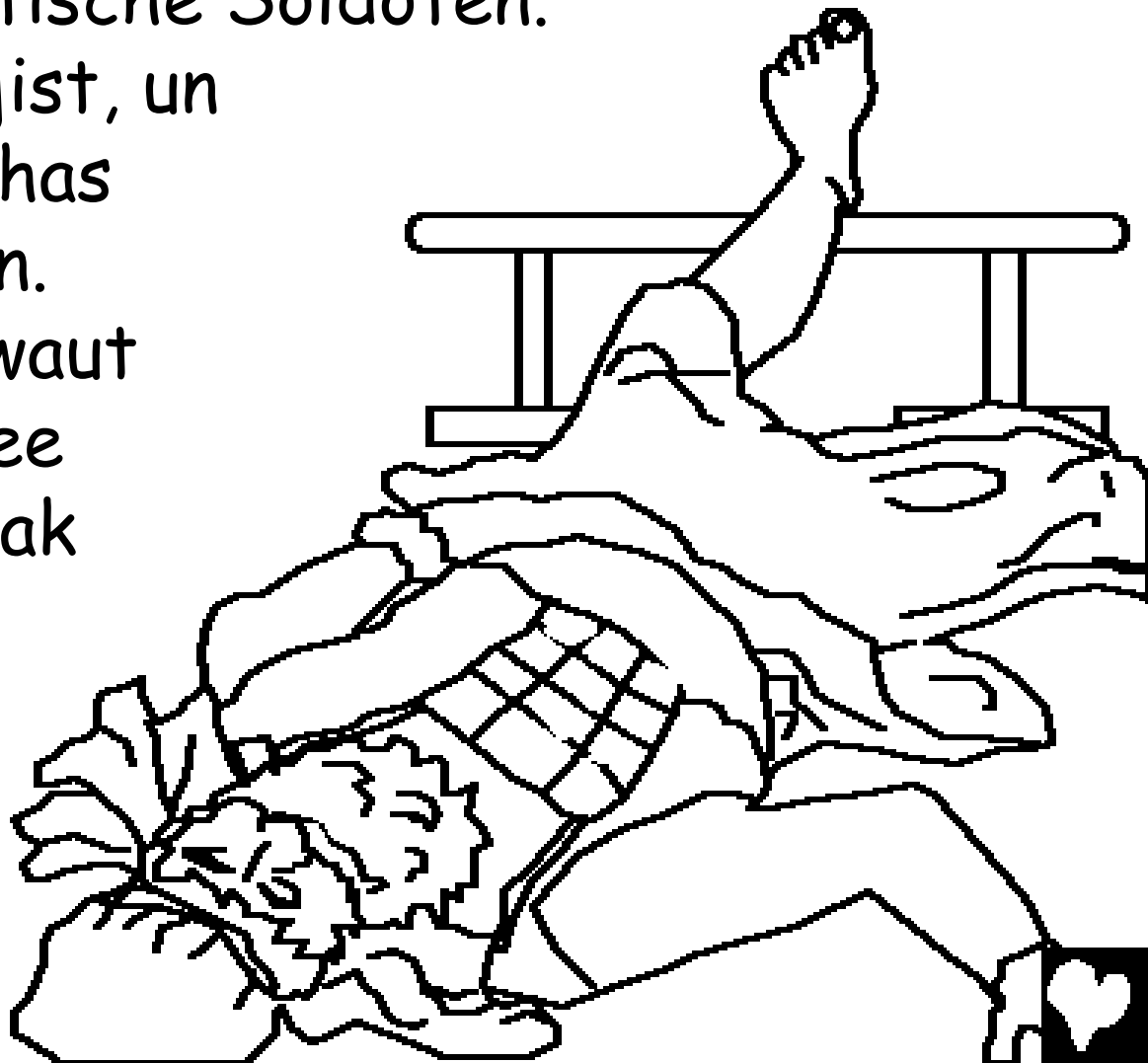

Gott siene Kjist brocht Trubbel fa de Filista. See
saden dee bie äaren Jetzen, Dagon. Dän näakjsten
Morjen wia de Dagon Jetzen opp sien Jesecht
jefollen. De Filista hoowen am opp, oba de
näakjste Nacht foll dee wada un bruak
en Stekja.

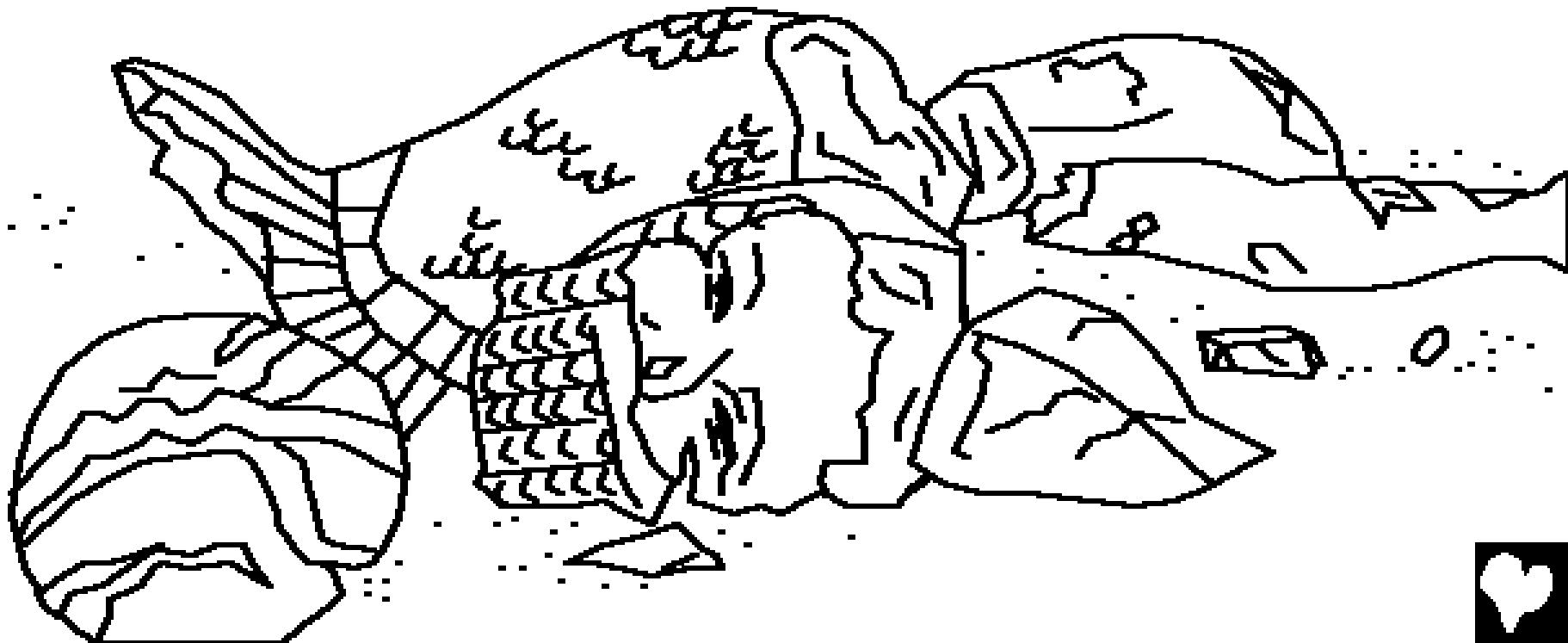

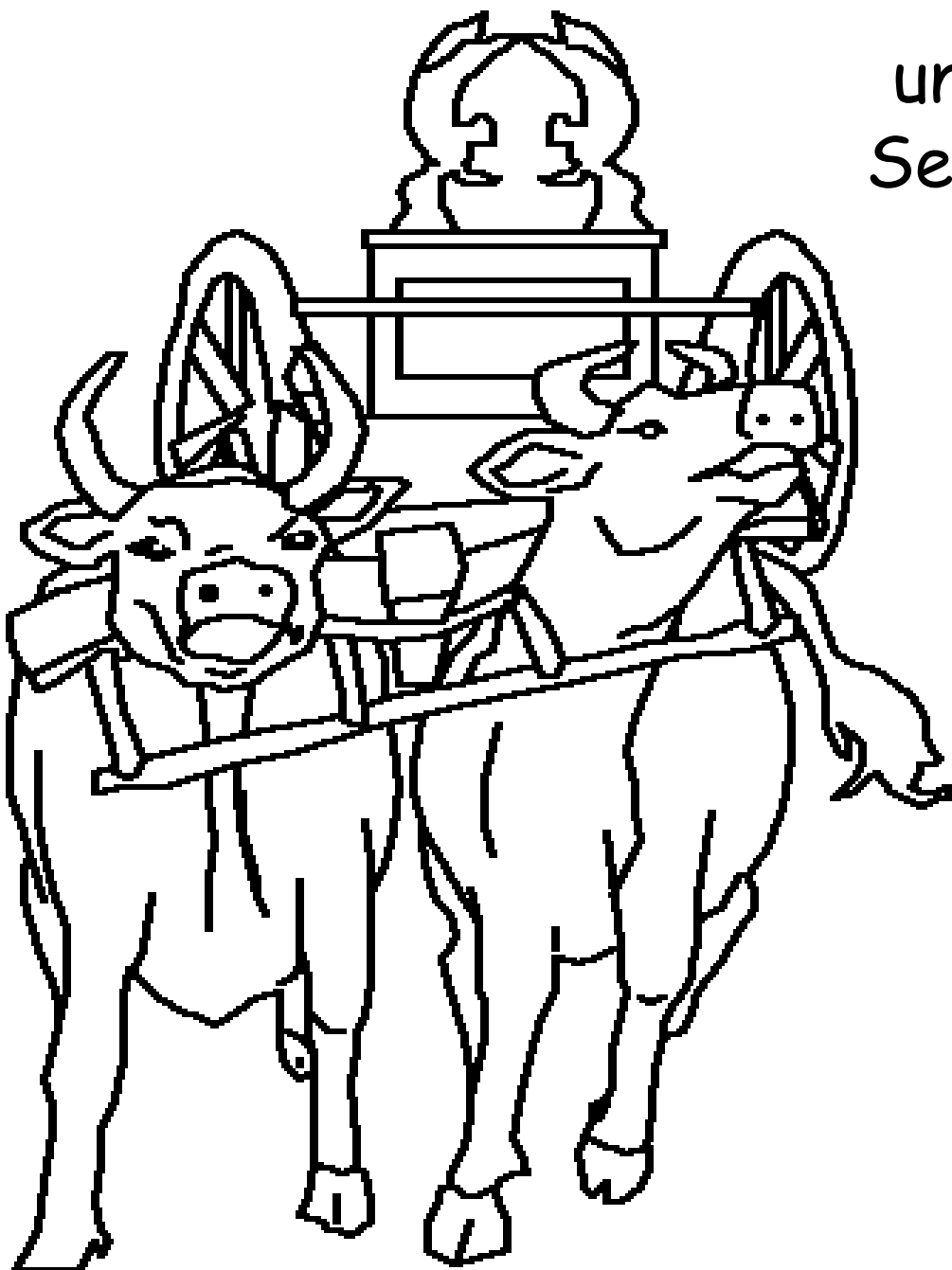

Nu kjeem doa Krankheit
un Doodes mank de Filista.
See wullen seenen auf Gott
an stroft. See saden de
Kjist opp een Woagen un
spaunden twee Kjeej
veropp. See hilden de
Kjalwa. "Wan de Kjeej
no Israel gonen un de
Kjalwa hinjen loten,
dan weet wie daut Gott
dit jedonen haft," säden
see. De Kjeej jinjen.



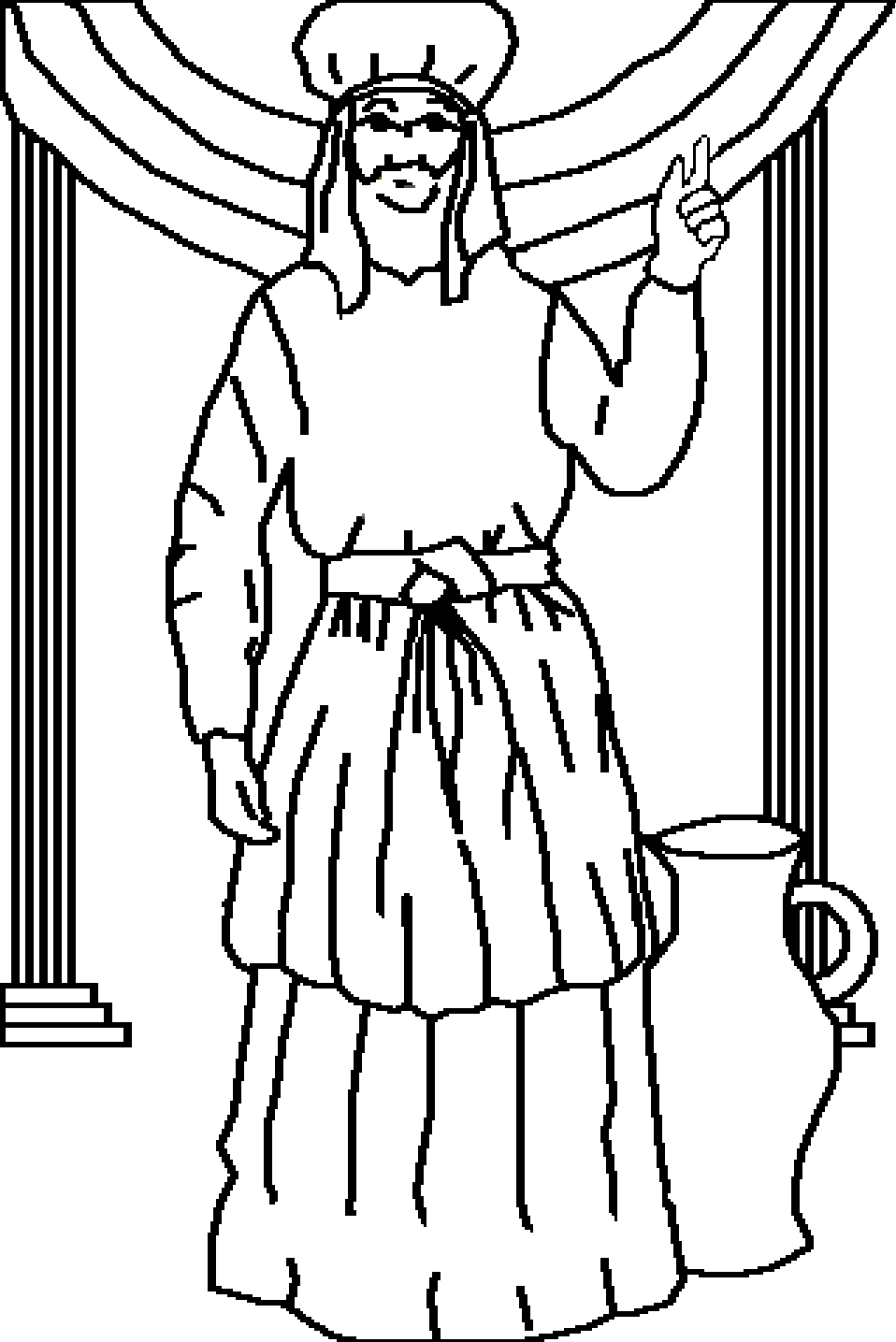

Samuel wia nu
oppjewossen, un hee
säd de Israeliten,
"Wan jie met jun
gaunset Hoat trigj
no däm Harn komen
... dan woat hee junt
ut de Filista äare
Macht raden."
De Menschen
jehorchten am, un
Har hilt de Filista
trigj en Samuel
siene Tiet.



Samuel, Een Jung dee Gott deend

Eene Jeschicht von en daut Wuat Gottes,
de Bibel

finjt eena en

1.Samuel 1-7

"Wan dien Wuat openboat woat,
jeft daut Licht." Psalm 119:130



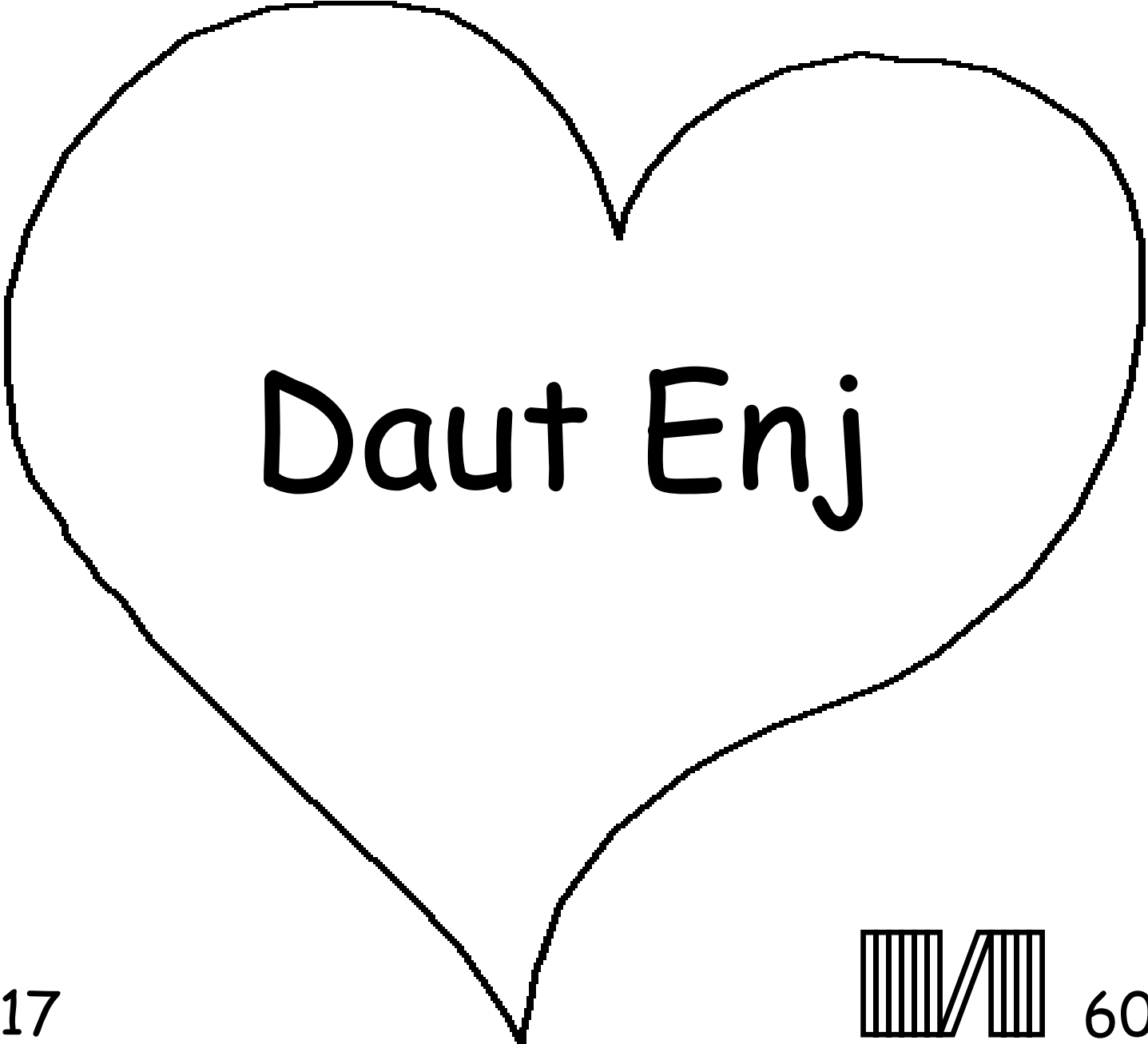

Daut Enj



Dise Biblische Jeschicht sajcht ons von onsen wundascheenen
Gott, see ons jemoakt haft un ons well kjanenlieren.

Gott weet daut wie schlaichtet jedonen haben, waut hee Sind
nant. De Strof fa Sind es de Doot, oba Gott siene Leew fa ons es
soo groot, daut hee sienen eensjen Sän, Jesus, schekjt, daut hee
aum Kjriez stoawen sull un de Strof fa onse Sind nämen sull. Dan
stunt Jesus vom Doot opp, un fua no sien Tus em Himmell! Wan du
dän Gloowen aun Jesus hast, un am frajchst diene Sind to
vejäwen, dan deit hee daut! Hee kjemt dan un läft en die, un du
woascht opp emma met am läwen.

Wan du dit jleewen kaust, dan saj to Gott:
Leewa Jesus, ekj jleew daut du Gott best, un worscht een Mensch
toom fa onse Sind to stoawen, un daut du nu wada läfst. Komm en
mien Läwen un vejeff mie miene Sinden, soo daut ekj nu nieet
Läwen haben kaun, un noch emol opp emma no die kom. Halp mie
daut ekj die jehuarsom sie, un fa die läw aus dien Kjint. Amen.

Lass de Bibel un räd jieda Dach met Gott! Joh. 3:16

