

Wainlalangare ole erere
Rurumong ake nge a Jona ome a silang aulonga

Jona na silang
aulonga

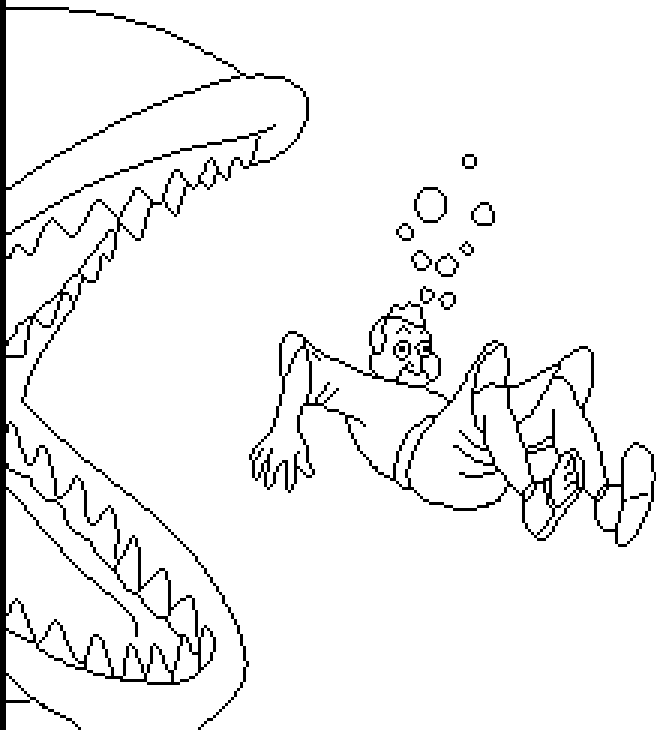

Ako Edward Hughes i wat i
Ako Jonathan Hay i wat a seire
Ako Mary-Anne S. i pakomkmoes i
Ako Hobson Mimi i eksing i
Wainlalangare ole erere ake
Bible for children i pavelpol i
www.M1914.org

BFC
PO Box 3
Winnipeg, MB R3C 2G1
Canada

©2017 Bible for Children, Inc.

I sivenga ako aro ong printim Rurumong ake na sung polpol i a
tokokoere nge. Ave mothong tova ong el umtun eve ur pelie nge
Rurumong ake omanga eve salimnga.



Nome nomenga ako a Israelre nge,
toko ako iion a Jona kene i voth nge.
Lama nge nang omole ako Patenger
i pake i a rempomnga a
Ninive. Na rempomnga
aken i mukal
nge

rempomnga
alavusnga
nge woplemi
aken.



Na Jona ile esong aken kene aro i
panongpol na i panakal toko na sengre
nge a Patenger ile riong, eneke
ole vothung kerengare
kene i auloleltun or lale
na nge ako
Patenger

ilemi
mire nge
ole vothung
kerenga
alavusnga
areken
mun lale.

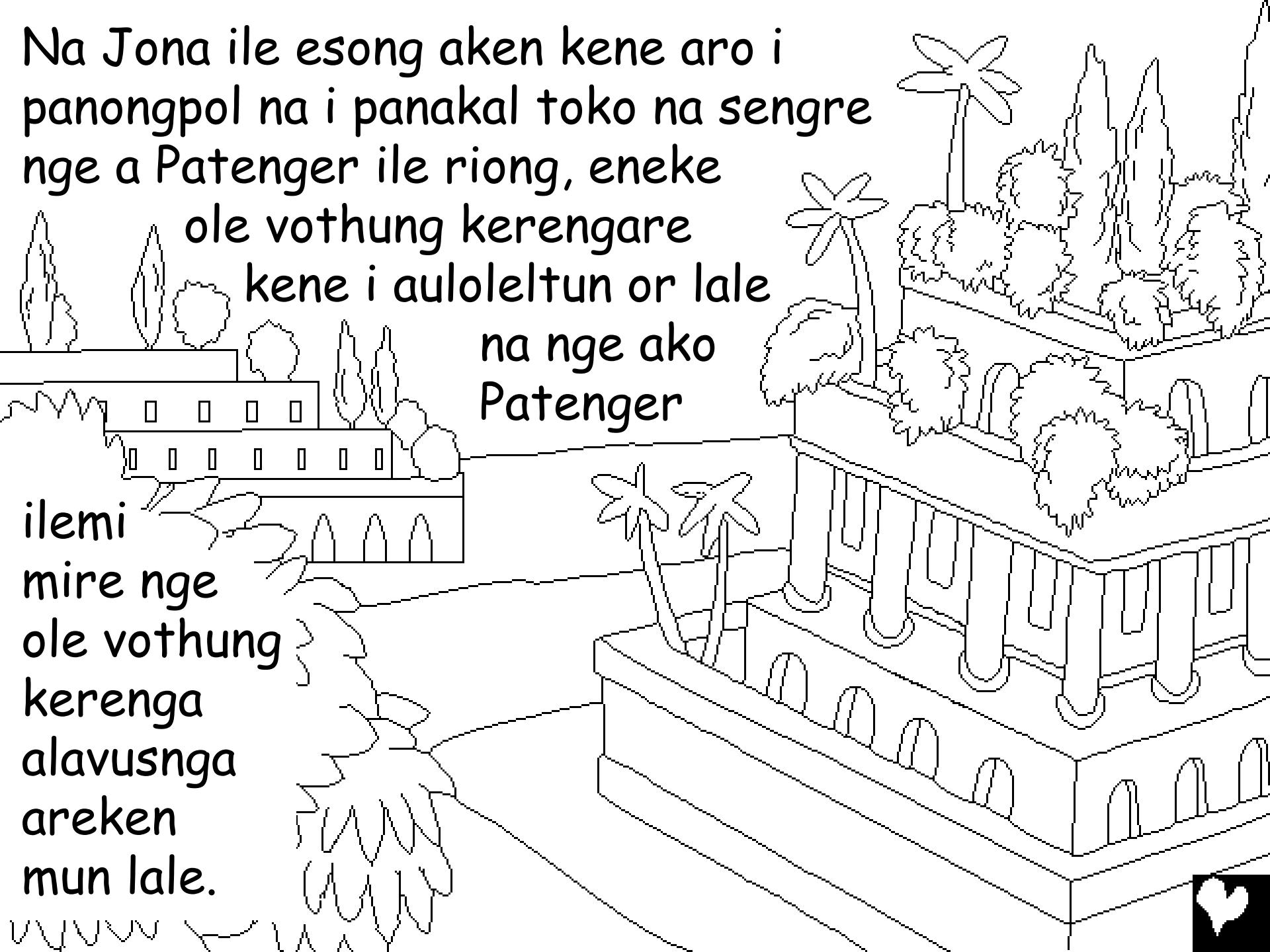

Aveto Jona i avsa Patenger
ile riong ma i roa nge imot
ma i lo a Tarsis la na i es a
Ninive ol a Ninive avele.



Mako Toko Pomnga i pake thue ome vit aulonga a
thev stha la ma thev ile punong i aulonga ma imot a
umongare o ngeip eneke o rivenga aro oa imot aken
aro i vlu.

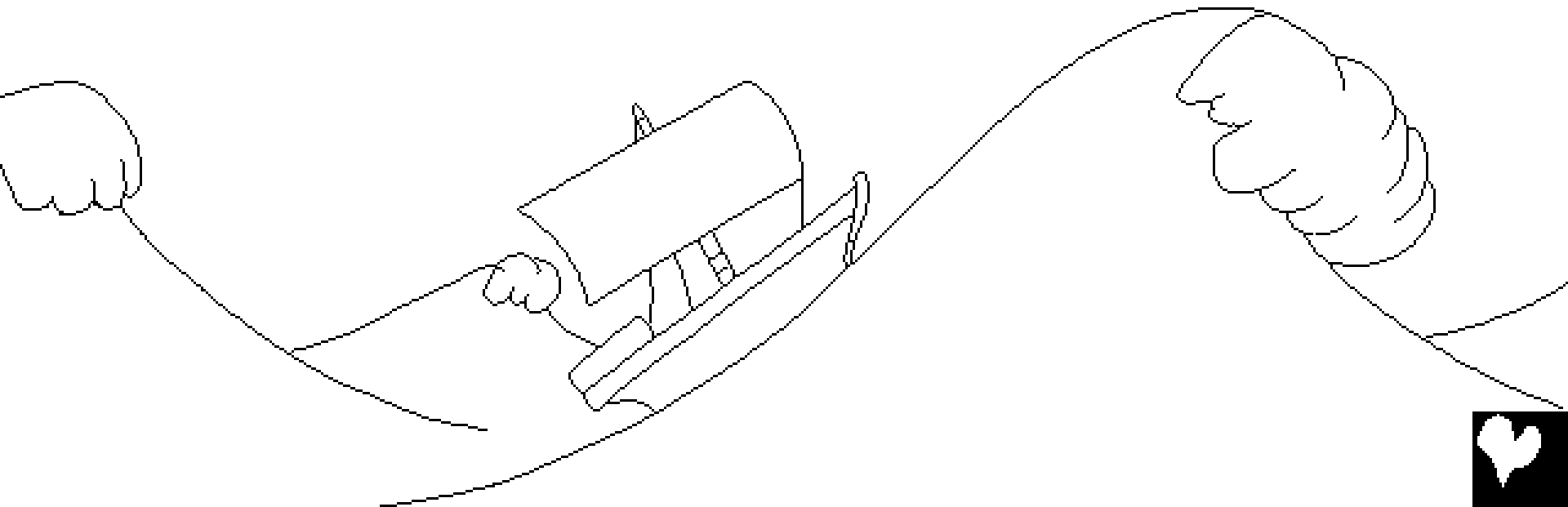

Ma rua ile punong aken i aulo aulo ma imot a
umongare sawir or ma o nong a ole avalare nge,
lamako o asissespot ole ur elonga pelie ako o paro
tomo i a imot nge, o oma venen
aken mo imot aken aro i vthoa
tie ave sivengaing
avele i velpol.

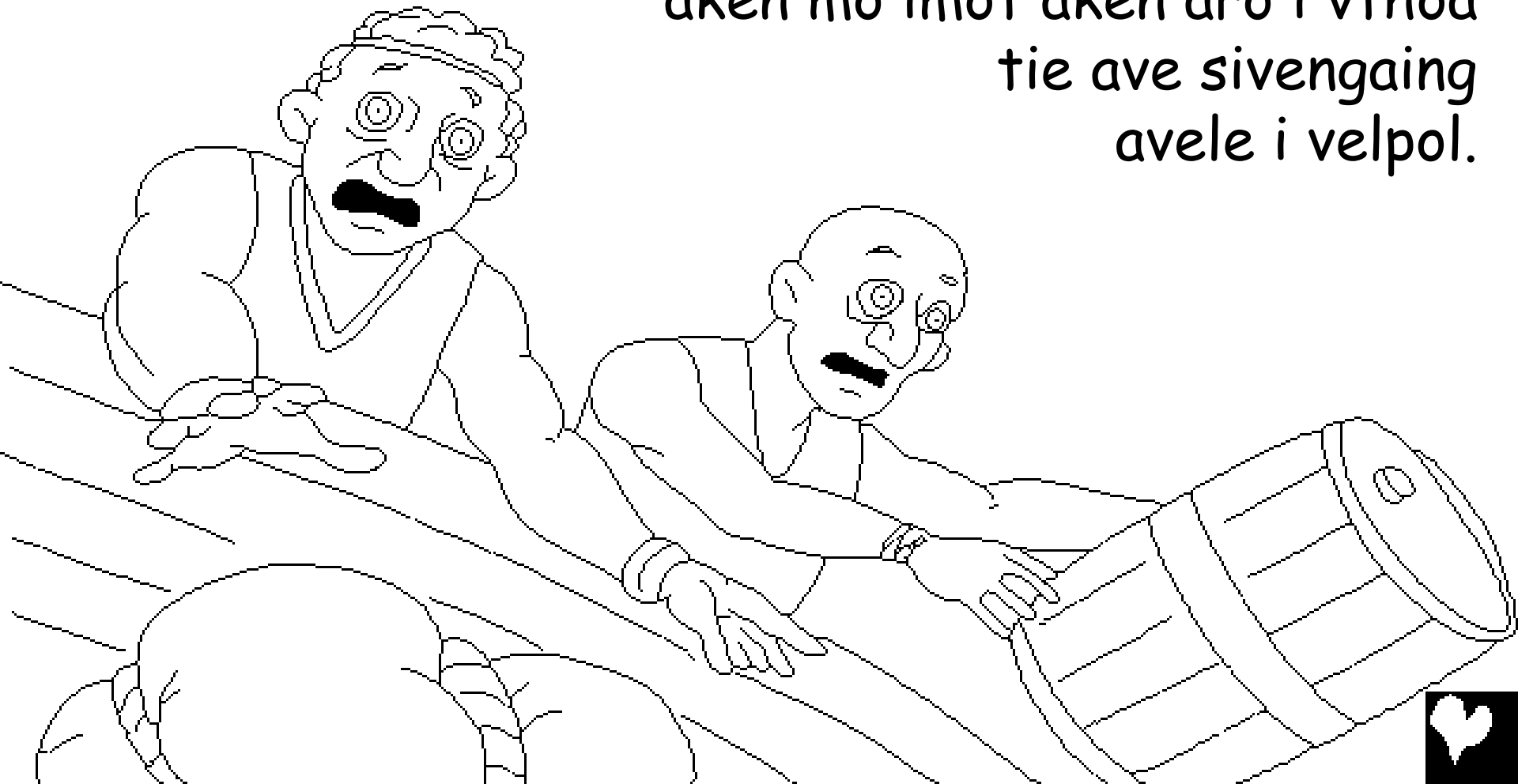

Na Jona i nongong vet inga ako a imot aken lemi na i nong vet avele ma imot aken a mukalinga i sangolo i ako i nongnongong ma i ria i ve, "Ke vo neke ake nongnong vet inga e? I pavurvur aro nong vet a lom Toko Pomnga nge avele, mo i opoal vet it ngekerengaing ake?"

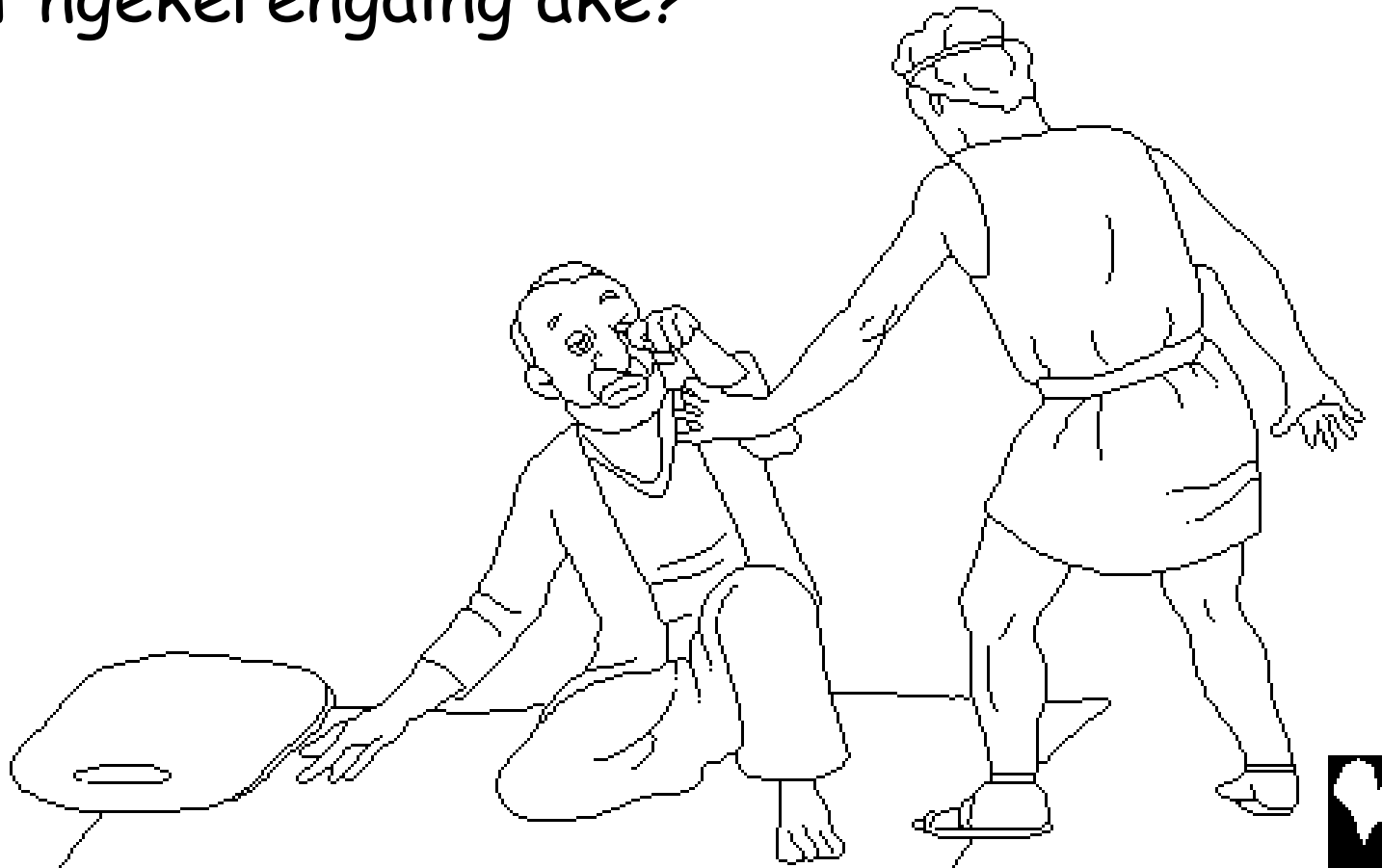

Lamako Jona i ria imot aken tokoningare ve ole kerengaing aken kene tepun ako a i nge, eneke i lo nge a Patenger ile pakeing, mako o nina i ve, "Varo them oma neke nge ong mo thev i ngo pis werer ol e?" Mako Jona i ria or ve, "Aro thomu o potuna tho mo o asespot tho a thev stha la. Akennga aro rua i ngo pisu ol."



Ma imot aken
umongare oniplong nge
a Jona iasespotnga
mako o tongporum
ve aro o pasong
viriviri imot aken
a wopo la ave o
pavurvur
avele.



Mako imot aken a umongare o nong ol inga a
Patenger nge,
nge a Jona ile
kerengaing
aken ve aro o
mit nge riong
avele lamako o asespot
ol a Jona a imot aken nge
ma i sivluku ol a thev lemi la
nakomala a ur e avele na
thue ome thev ile punong
aken i vus ol ma olemi
pelekpil na o ngeip
mako o lotual ol a
Toko Pomnga.

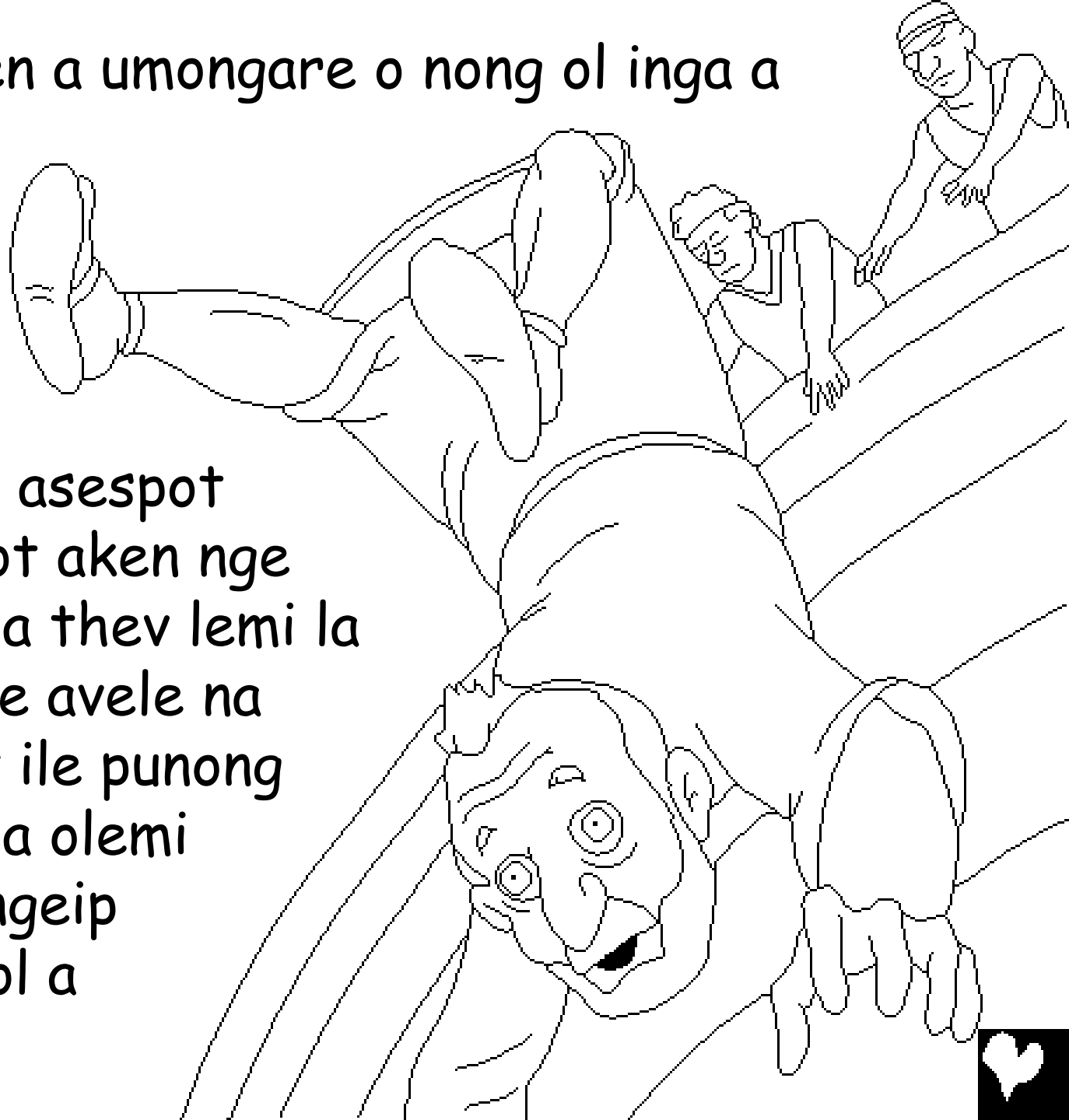

Na toko riong
avsanga aken i
rivenga aroko e
avele aro i opola
ol i na ilemi mire
avele ako aro
Toko Pomnga
aro i opolal
mun i.

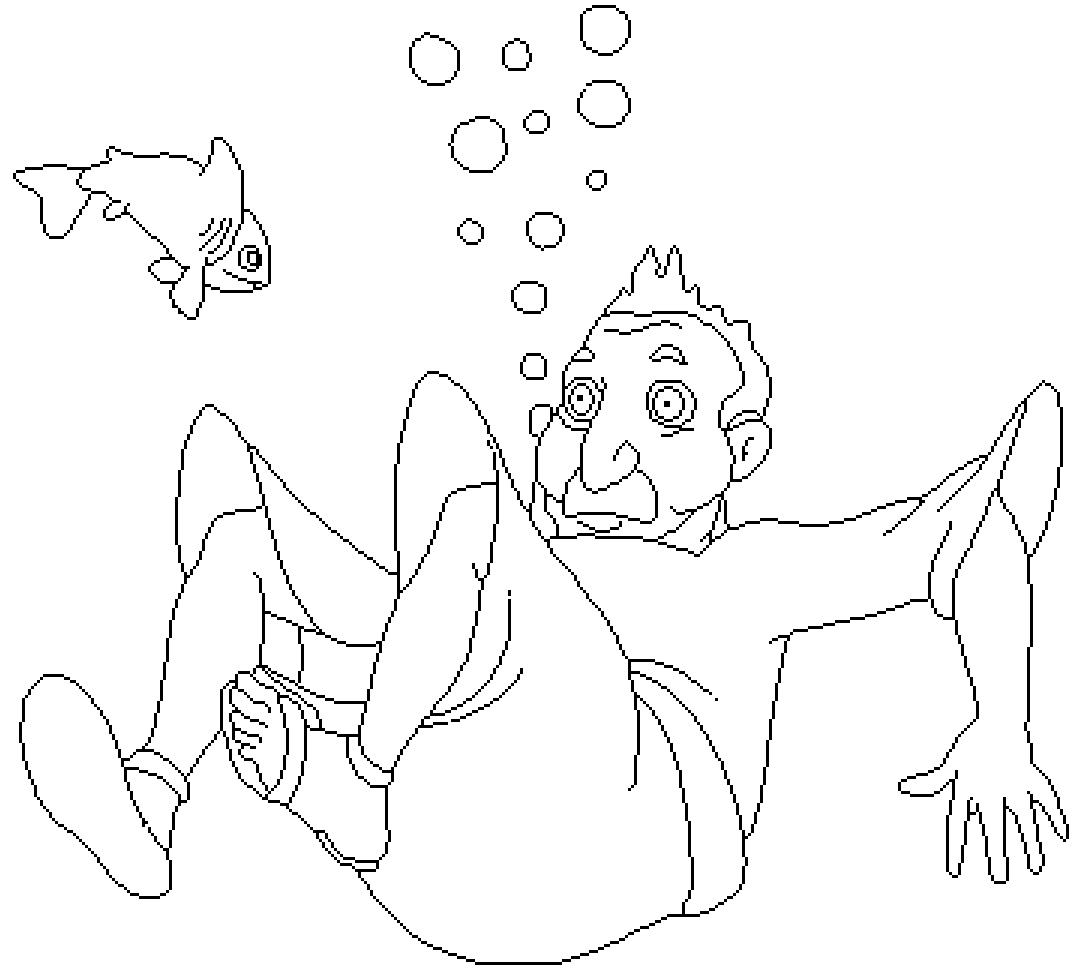

Ma Toko Pomnga i monsi silang
aulonga e ako ma i mit vengtun nge
pen ako Jona aro i sivluku nge, mako
a ur e avele na i onutetu a Jona. Ma
i voth a silang aken iopo lemi nge
nang orme.

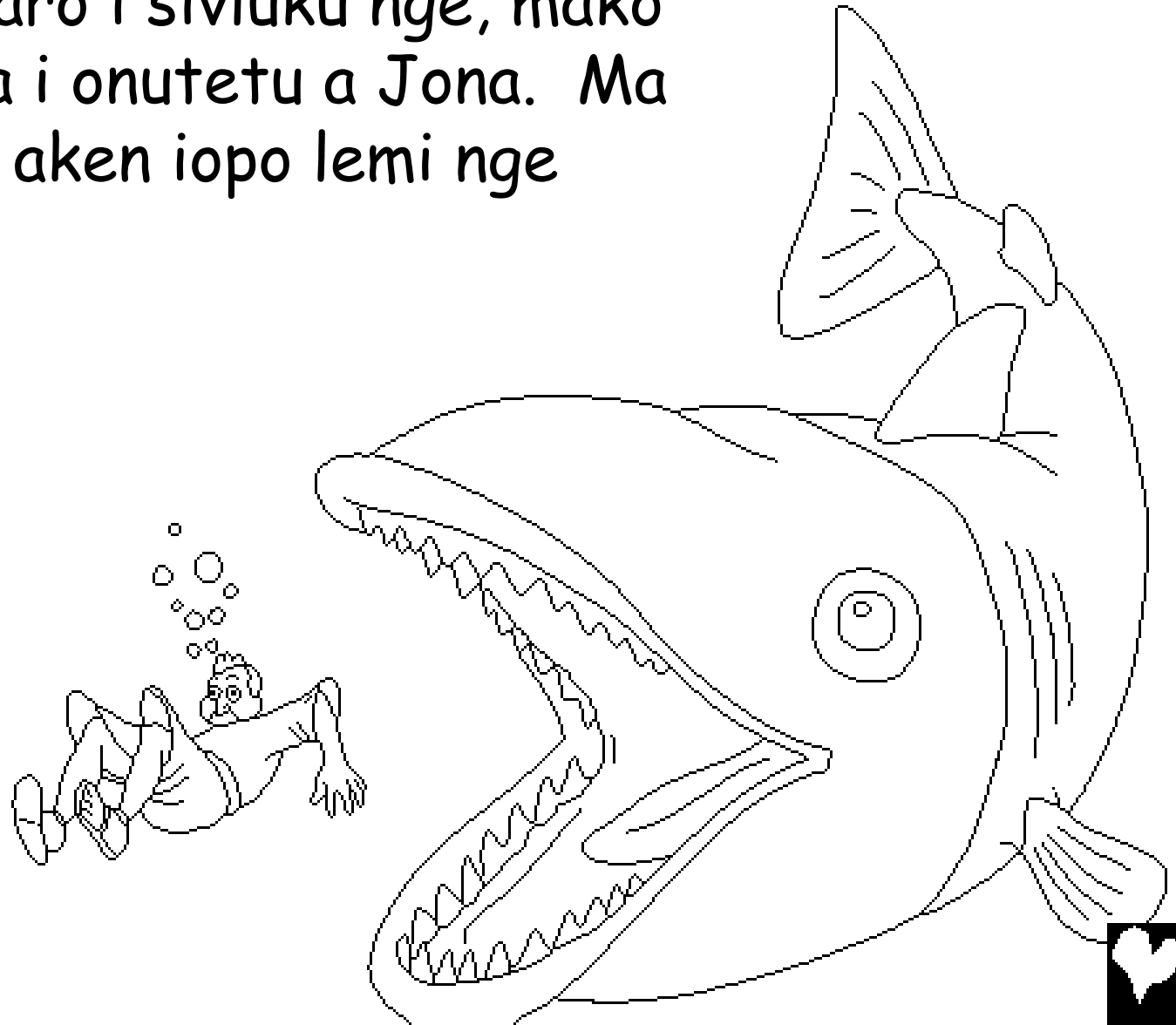

Ma nang orme i vus nako Jona i eksing ilemi ma i ria
ve aro i avsa ol a Toko Pomnga ile riong avele ol,
mako Patenger i ria ma silang aulonga aken mo i
paeso i a wopo la ma i muata i a wonwonpo.

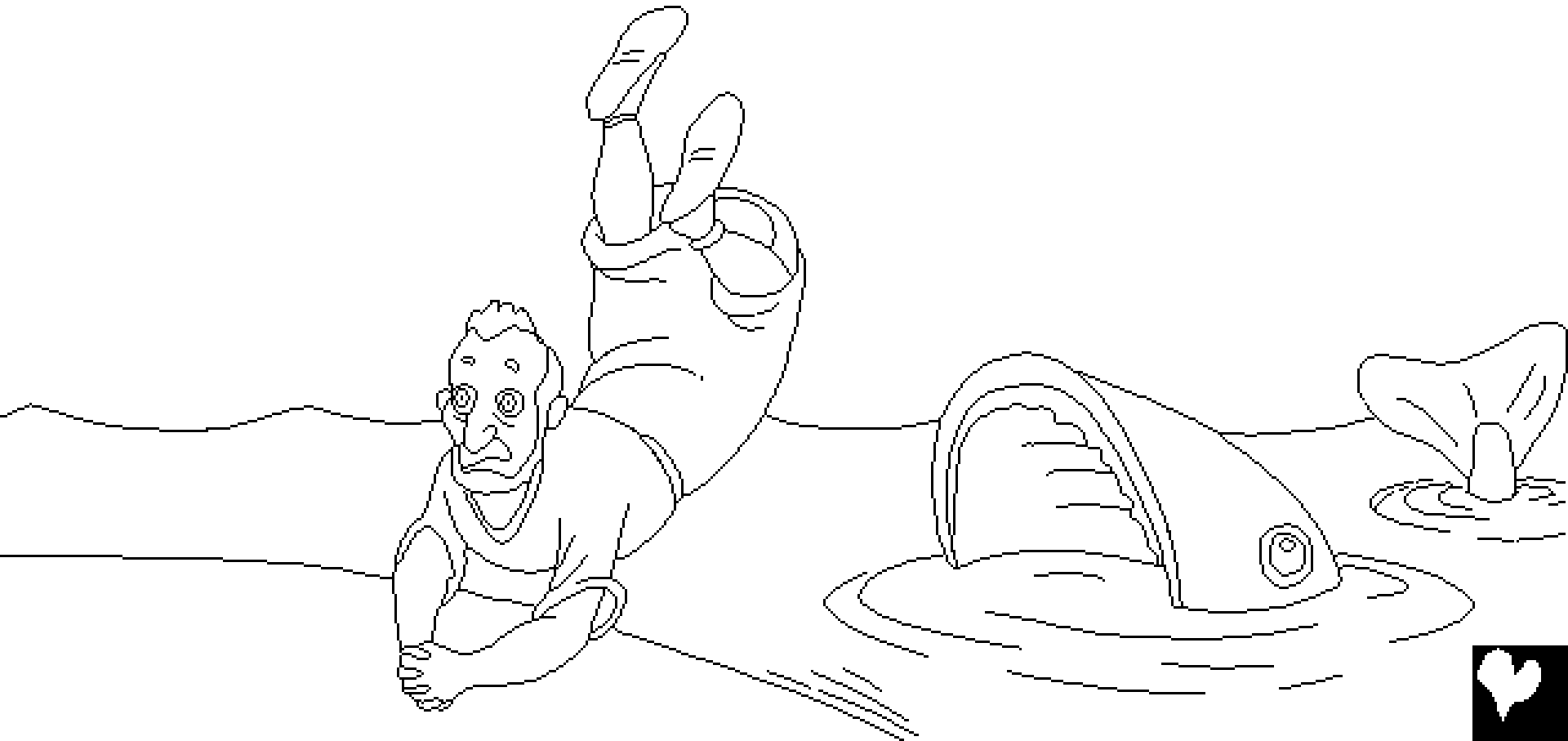

Mako Patenger i pake werer mun i ve aro
i es mo i panongpol nge ile riong a Ninive,
ma Jona i esa ol a Ninive la ma i avavras
ol ma i ri ve, "Nang or mulepapenel aro i
vus naro Ninive aro vusu."



Ma toko na seng Ninive anga areken tomo nge ole nepes olemio nge a Toko Pomnga ile riong aken, mako o eksing olemi ma o sem na o parara ole teunongre ma o vor vuvus a opo na o nong a Toko Pomnga nge mo i mothong tova i pakarenga or.

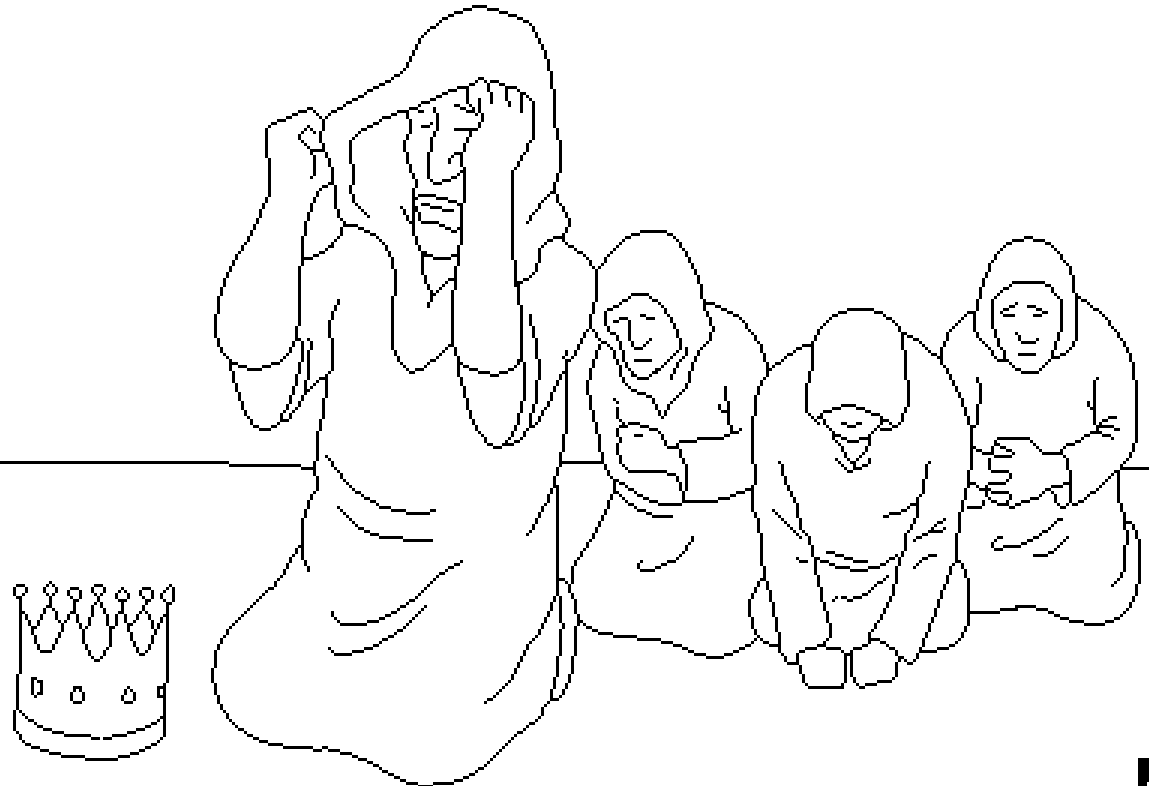

Ma Patanger ilemi eksing werer mako i ikris ile
kinong aken ma nge nang aken toko na seng

Ninive angare peraling
aulonga i voth
a or nge. ...

Ave toko inga
omole ako i
peral avele,
kene ini
a Jona.

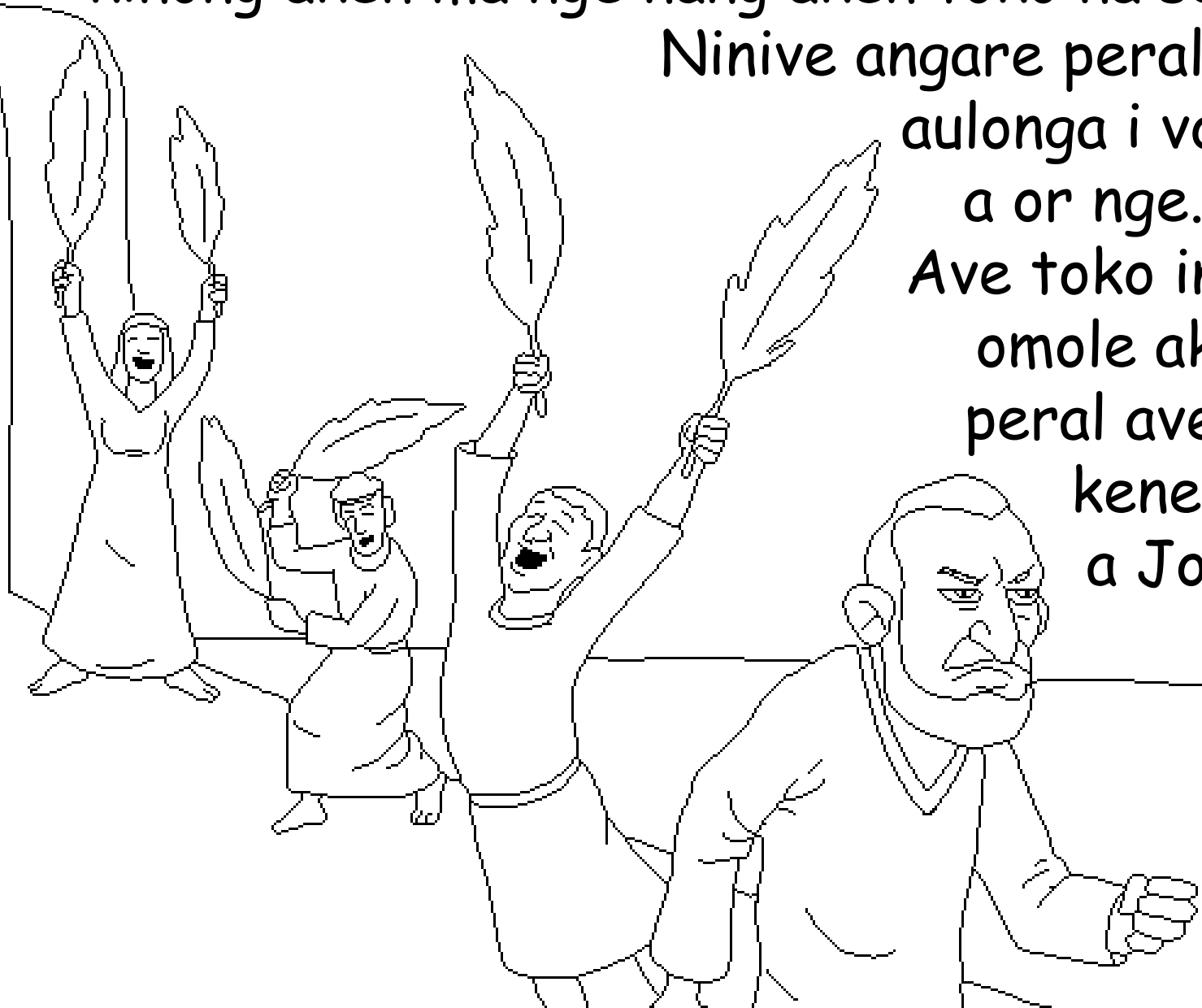

Na Jona ilemi kling
eneke Patenger i eksing
werer ilemi nge or mako i
ria Patenger ve, "Ong ini
toko asaguonga na ong
vual nge lemi esaling na
lomum kling viriri avele
na ong vual mun nge
vothung le sivengaing."
Na Jona i ri venen aken,
eneke ilemi mire lale ako
ve Toko Pomnga ilemi
esal werere or lale.



Ave Jona kene ilemi kling rintet mako i ria Patenger
ve, "Eltetpot lek mimiong eneke mimiong ake i
sivenga ol a tho nge avele, na i sivenga
tova tho rin inga."



Mako Jona i espot a remponga aken, ma i menen mo
i thepol vet ako aro Toko Pomnga aro i oma neke nge
i, ave Petenger i monsi we e ako ma i pom viriria inga
nge nang aken ma i velpol
ini a Jona ile mlil.



Lamako nge rulponga nge nang ainiga Patenger i pake mana e ako ma i an vustetpot we aken thoingre mako we aken i rin selele. Lama Patenger i oma nang ma anresalinga i aulonga rintet ma i antun a Jona ma toth ile rinong ma nge tepun ake Jona ile lemikilngong kene i anangal seles ol.



Lamako Toko Pomnga i ria Jona ve,
"Ini lom neke ako lomum kling e?
Na lomum esal we aken ini lom
omaing? Na i ploa aken pemlik
naro i rin mun pemlik.



Naro lemik esal rempomnga a Ninive
avele ke, rempomnga aken toko na
sengre nge mengmeng avelle?"



Jona na silang aulonga

God ile erere a rurumong i voth nge

Jona

"God, lom riong i sung mire ninenga a
tokoere nge." Voing 119:130



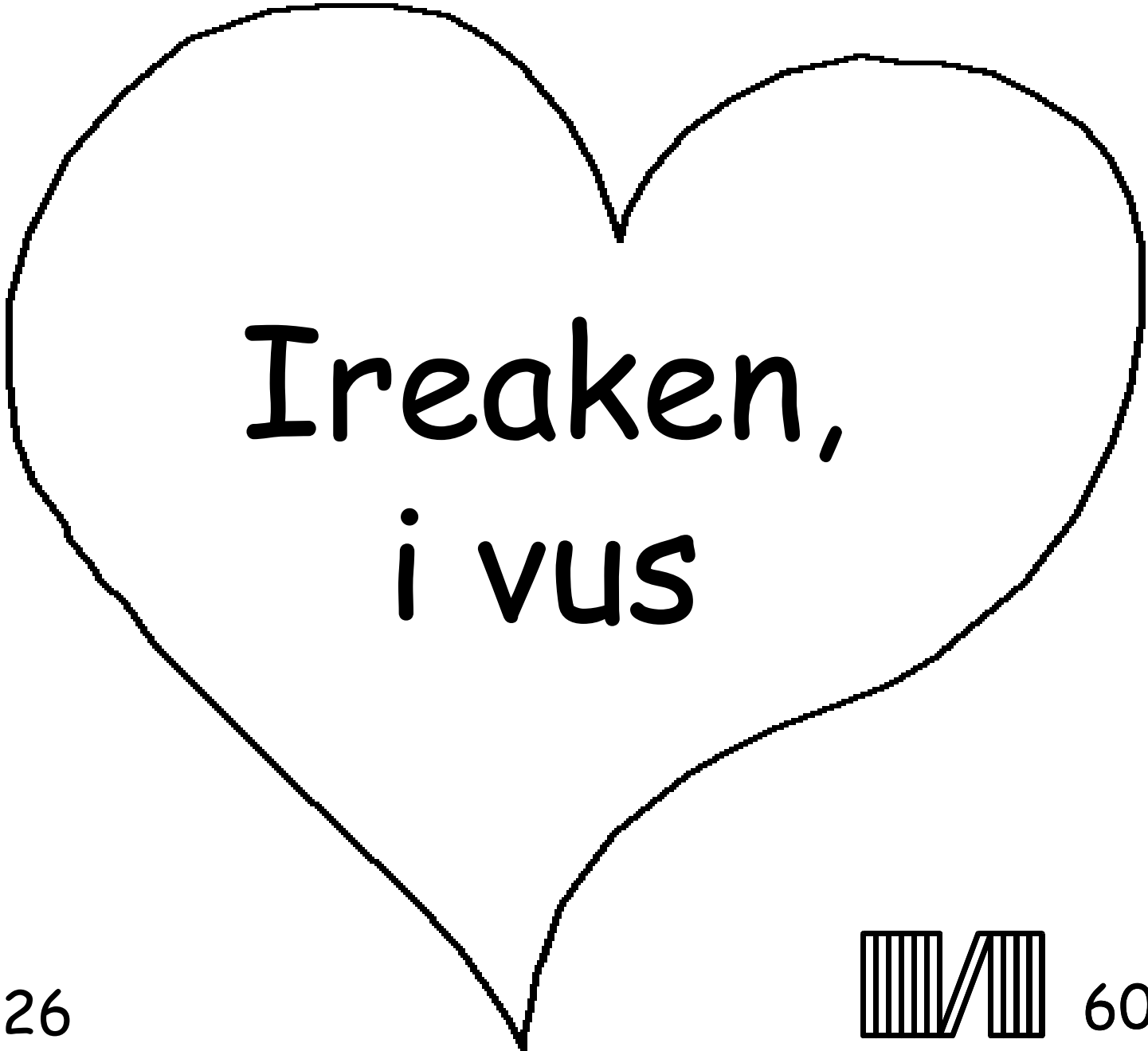

Ireaken,
i vus



Rirumong sivesivengaere ako i voth a Patenger ile erere
lemi ako i pamen it alavusnga na i sis ve aro lemire mire nge ako ve ini ao.

Patenger ilemi mire nge ler vothung kerengare lale, na vothung kerenga
kene onga ini rinong, aveto Patenger ke kene ile asaguong i aulonga
rintet, mako i pakeu itun omolenga ako mo aro i mon a won ngoronga nge
mo ini ler vothung kerengare paolalnga. Ma i rin mako i mimi werer mun,
mako i voth ol a penaurvet! Na arove lomumo nge i na ong nong
tangosinga a i nge aro i eltetpot lom vothung kerenga na akennga i
nunganga aro i velpol ini ol om pomnga naro i mimi a ong nge naro i voth
tomo nge ong evelelnga ako aro ile vusonga avele.

Tova ve lomumo ve riong ake i nunganga aro ong nong ve, O, teik a Jisas
ong ini ok pomnga na ong ini Patengemem mun na ong velpol ini toko ma
ong rin nge lememe vothung kerengare lama ong mimi werera mun, make
ponange tho nong tangosinga a ong nge wot mo ako aro lomum simikal lek
vothung kerengare naro tho el mimiong ponganga. Na nge nang sivenga
omole aro tho voth tomo nge ong evelelnga naro ong opoal mun tho mo aro
tho nongal keum, naro tho panes ong ranga ve ini tum. Inunganga

Evelelnga aro ong tital a Toko Pomnga ile erere naro
ong lengleng tomo nge i nge nongong. Jon. 3:16

