

Buku Taroma li Lowalangi
(Ni'amoni'ö) ba ndraono
Ni'fa'aso

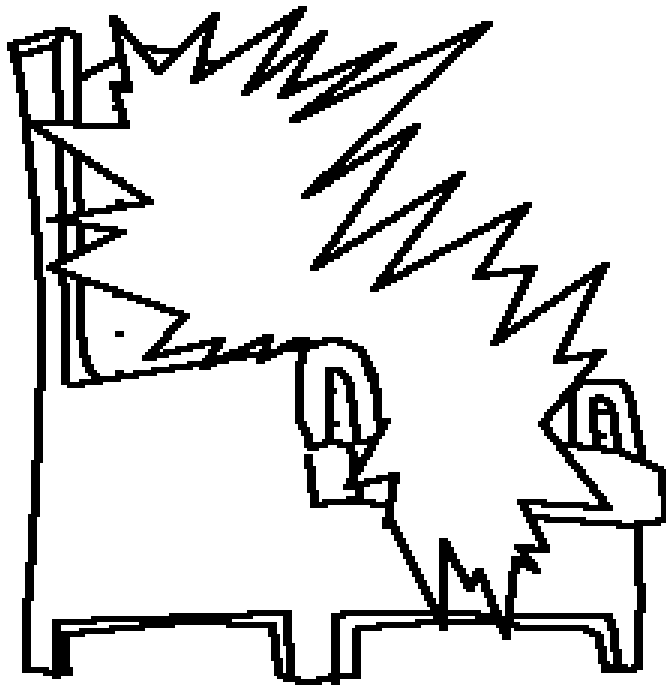

Sorugo,
nahia si
sokhi
sibai



Ni'sura: Edward Hughes
Ni'amaedolagö: Lazarus
Ni': Bob Davies; Sarah S.
Ni'fo'eluha: Dorkas Orienti Daeli
Ni': Bible for Children
www.M1914.org

BFC
PO Box 3
Winnipeg, MB R3C 2G1
Canada

©2011 Bible for Children, Inc.

Lisensi: So sitobali dana (hak) ba wango'oya'ö
nidunö'dunö andre asala lö lafamawa.



Me so Yesu ba gulidano ba no I'ombakha'o khora
nifahao-Nia sorugo andro. Ifotoi da'o "Nahia
Nama-Gu", ba imane ba da'o oya
nahia segebua. No ebolo
sibai, ba sokhi sibai.
Sorugo andro ba no
nahia si sokhi moroi
ba nomo si so ba
gulidano andre.



Ba imane Yesu, "Möido ba wama'anö nahia khöu. Ba na no U'fa'anö nahia da'ö ba U'fulido wamaondragö yaugö ba U'ohe ami khögu." Ba mangawuli Ia ba zorugo me no maoso Ia moroi ba ngai zi mate. Ba la'ila da'ö ndra nifahaö-Nia. Ba me tefazawa Ia miyawa ba so lawuo solohe Yaia.

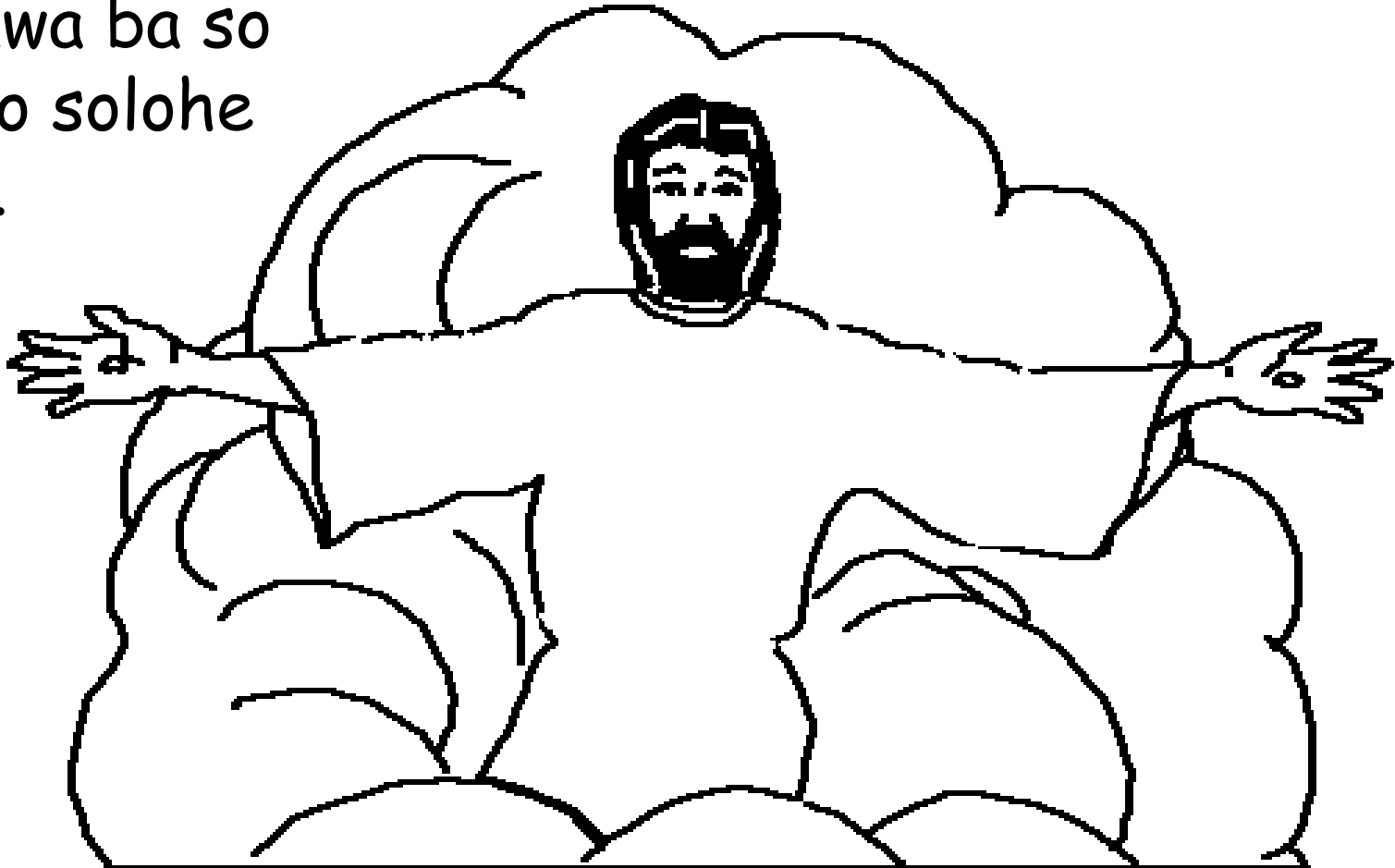

Ba I'otarai da'ö ba la törö'törö tödöra niha keriso.
Ba I'wa'ö Yesu si lö mu'ila ginötö we'aso-Nia si lö
mudöna'döna. Ba hewisa niha keriso
si no mate fatua lö si so Ia?
Ba no Ifaduhu'ö taroma li
Lowalangi wa fao göi ira
khö Yesu dania, ba zi
so Lowalangi andrö.

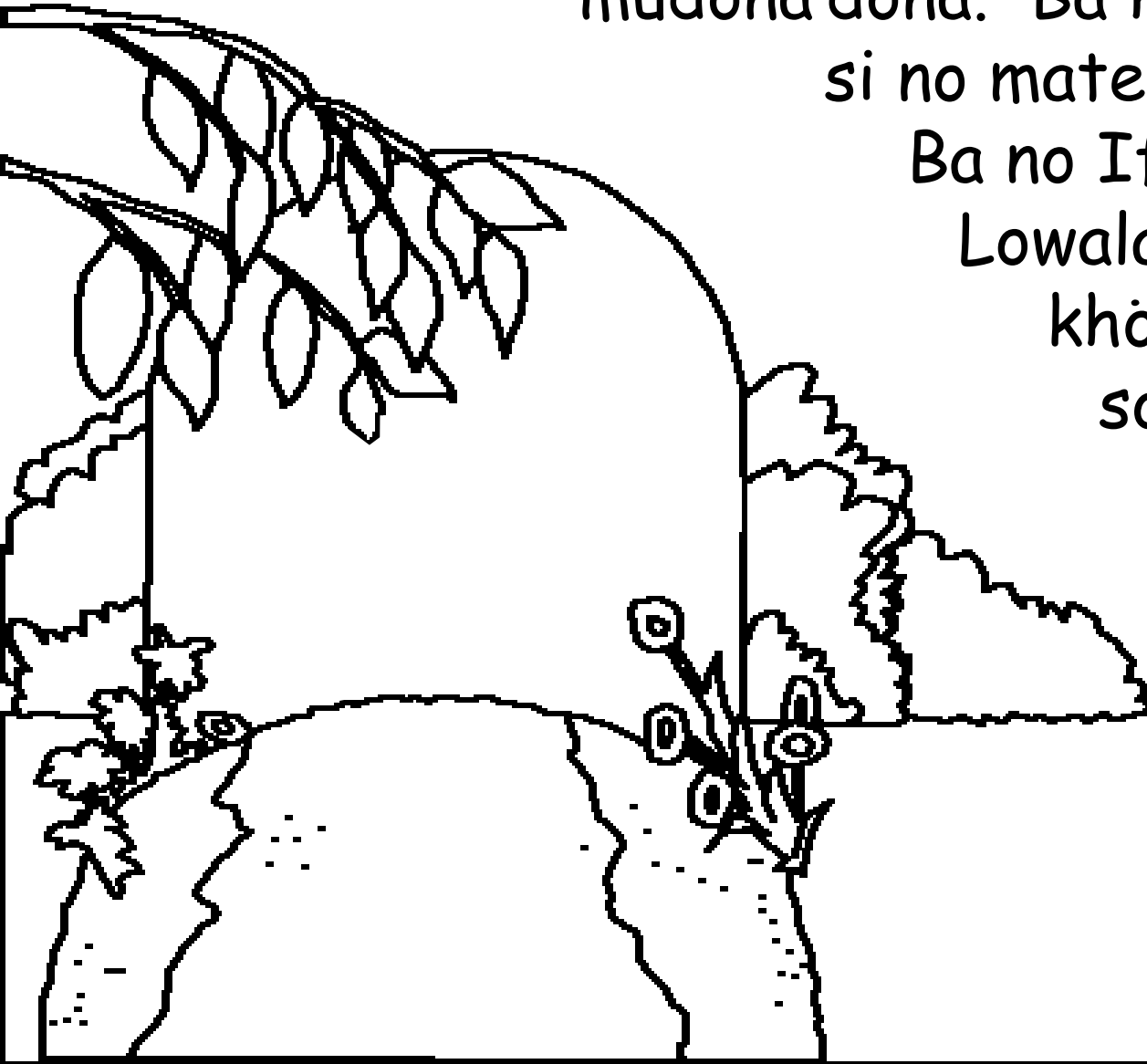

Sura wama'ele'ö no sura afuriata ba mbuku daroma li Lowalangi, tefaduhu'ö wa hawa'asökhi zorugo andrö dania. Lö si sökhi baeronia, ba lö famaedo lalania. Me sorugo andrö ba no omo Lowalangi. Gofu heza so ba so Lowalangi ba dadaoma-Nia ba ha ba zorugo.

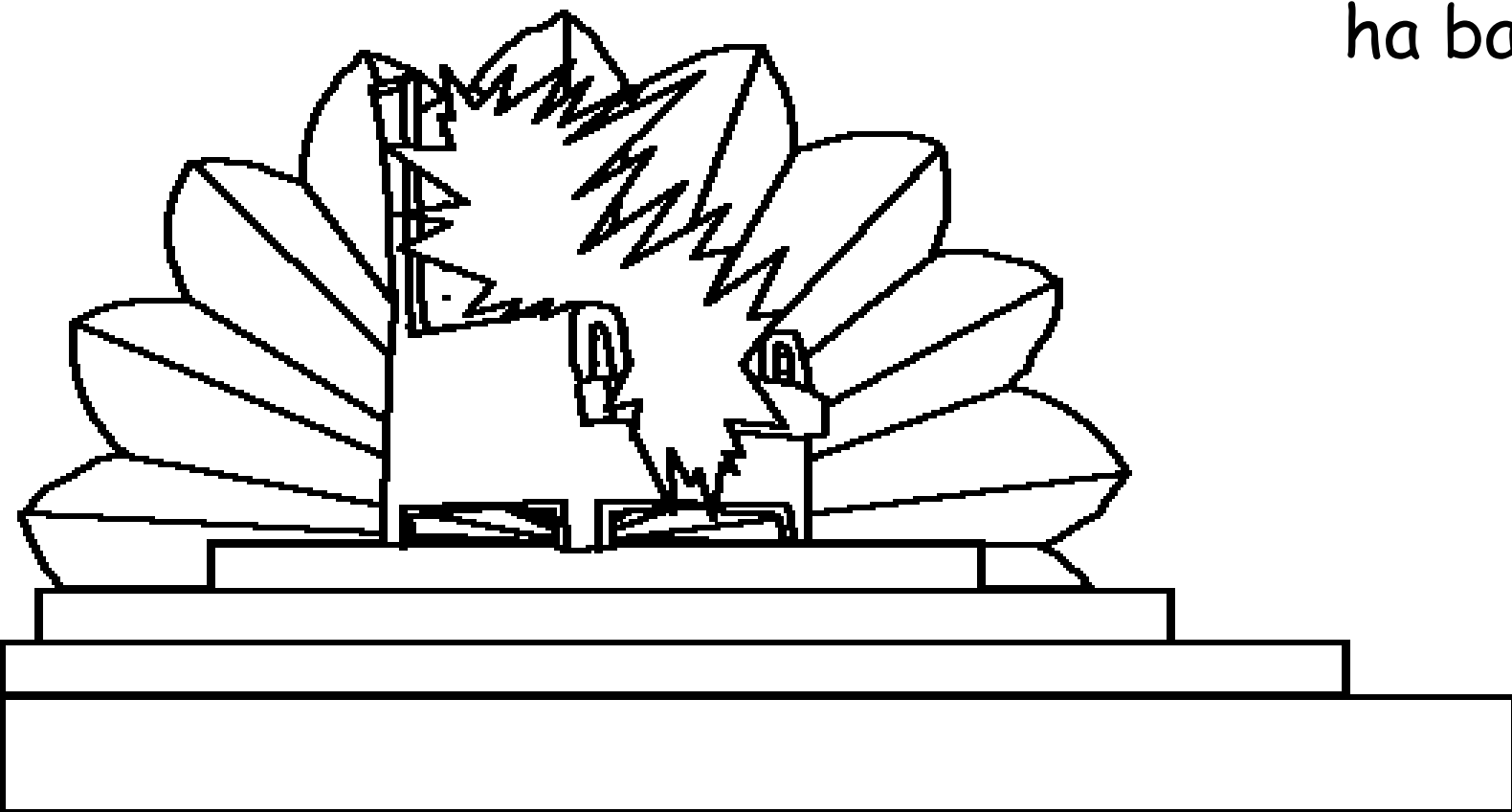

Fefu ndra malaika ba zorugo
ba oi lasuno Lowalangi. Ba
simanö solo'ö Lowalangi si no
mate ba gulidanö andre ba
zorugo so ira. Ba fefu ira
manunö lasuno
Lowalangi.



Ba la'anunöisi sambua zinunö: Sinangea Ndra'ugö
ba wangai buku andrö ba ba wamokai tandronia.

Börö me no mutaba Ndra'ugö
ba ndro-Mö irege no Öhöli niha
khö Lowalangi moroi ba ngawalö

mado fefu, ngawalö
li ba ngawalö
soi ba moroi
ba ngawalö
niha fefu.

(Fama'ele'ö
5:9)

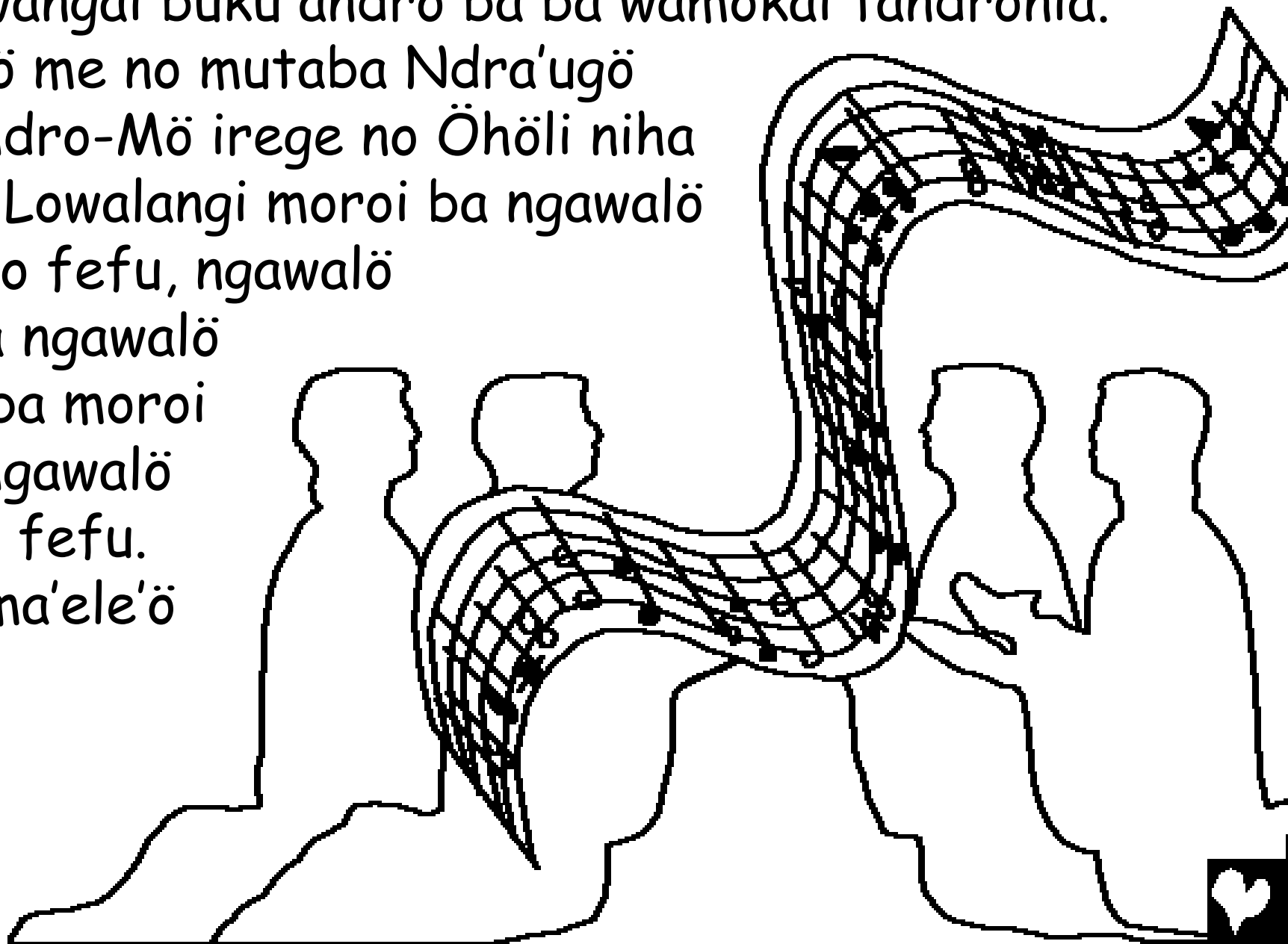

Ba nga'örö afuriata ba buku daroma li Lowalangi,
te'ombakha'ö khöda zorugo andrö yaia "Yeruzalema
sibohou". Ebua ba alawa sibai gölinia. Ba'a'ba'ania
ba moroi ba gara safusi si no muhaogö.

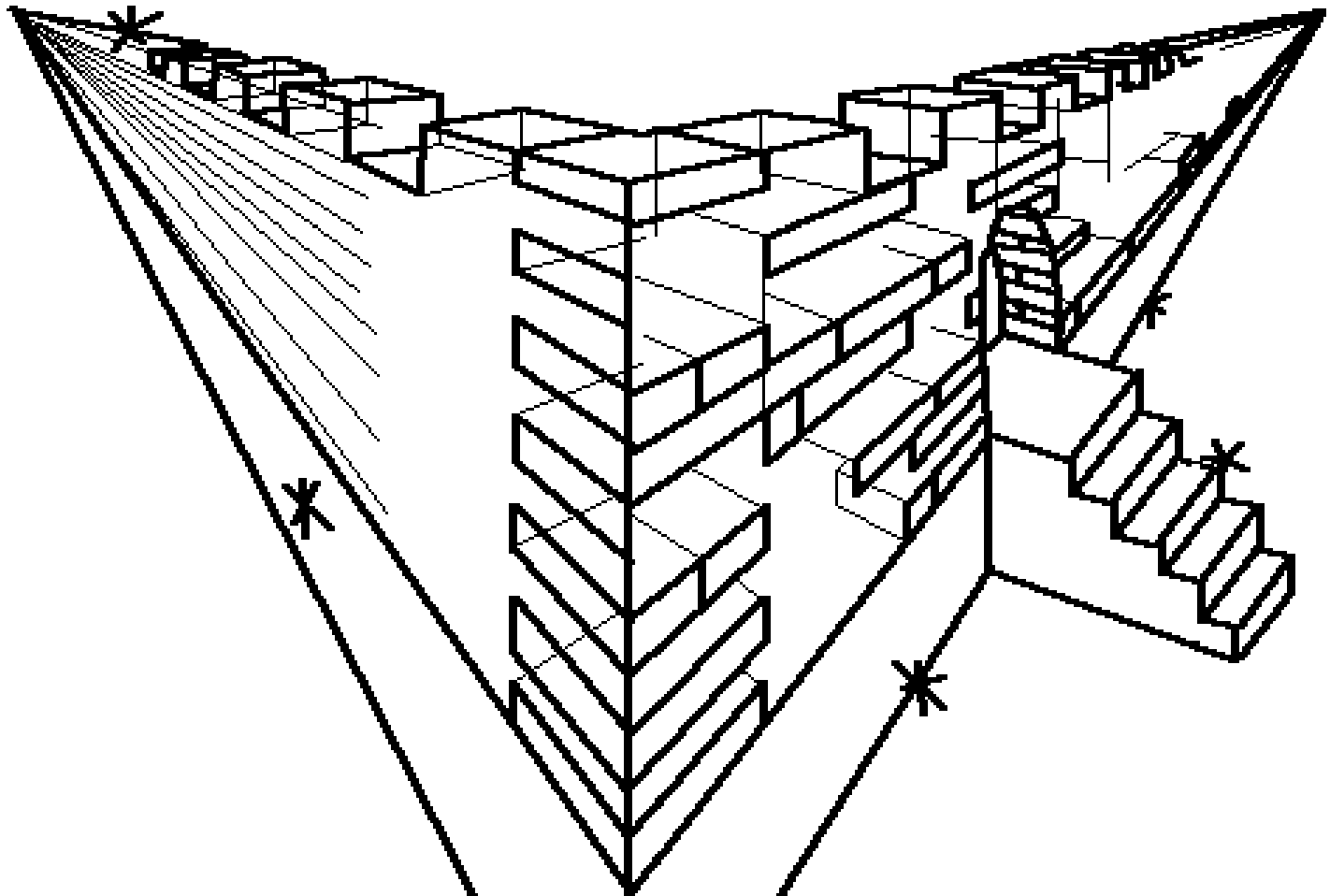

Bagolönia moroi ba gara safusi ba si takile.
Feremata ba hulö gara baduri sinasa zombalugö
danedanenia, oi takile ba oya ngawalö la'a'la'ania si
sökhi sibai. Ero bawandruhö mbanua tefazökhi ba
manimani sebua böli.

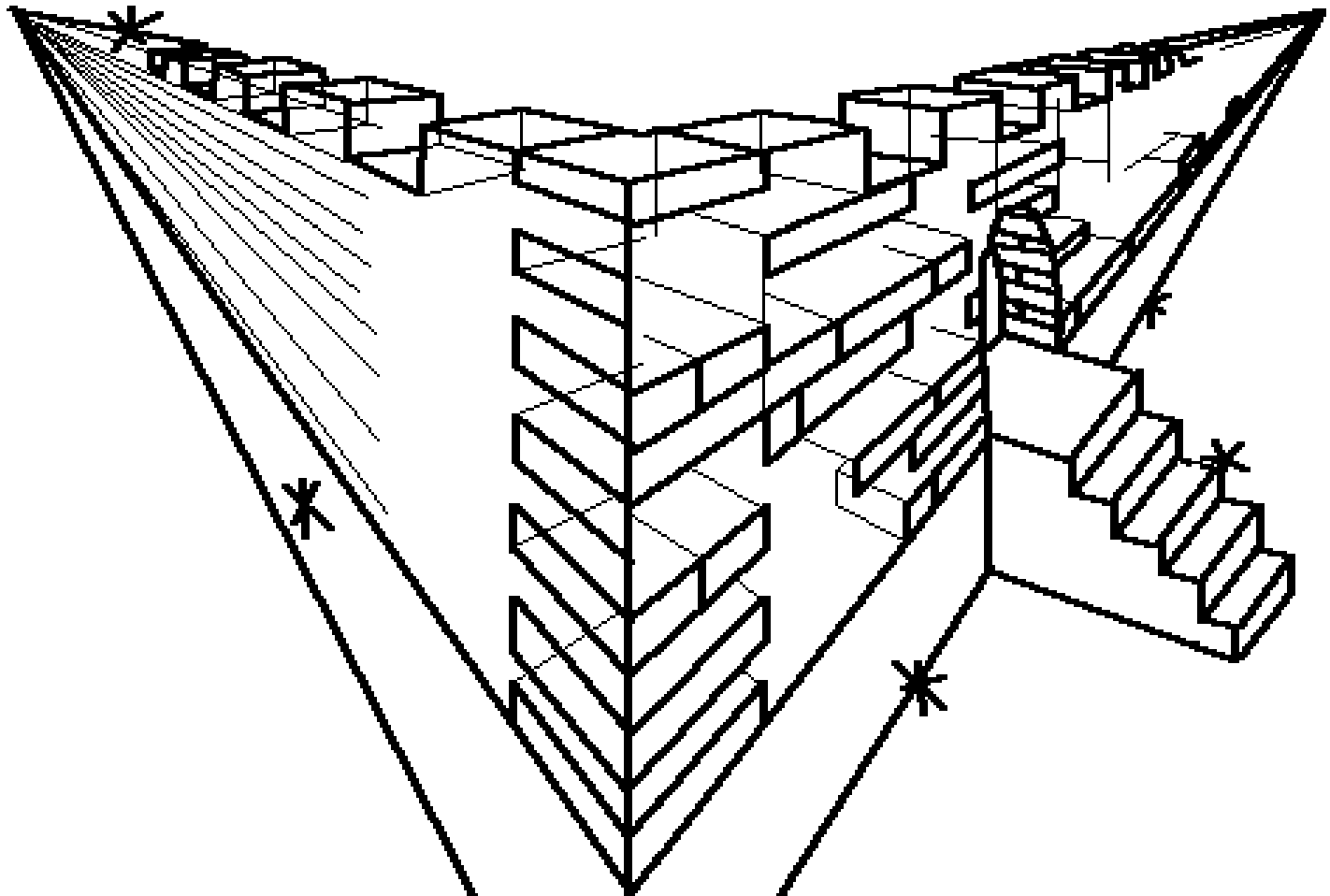

Baŵa göli manimani sebua andrö, ba lö irai teduhö.
"Mi'aine ba mifaigi" hawa'asökhi yomo, oi moroi ba
gana'a si sökhi mane sörömi safusi ba moroi
ba gana'a fefu
la'a'la'ania.



Ba no si sökhi, so nidanö sohahau mangele moroi
ba dadaoma Lowalangi andrö. Ba zinga nidanö tanö
bö'ö ba so döla geu fangorifi simane si so ba kabu
gedena. Tola geu andre ba I'owuaini 12 ngawalö bua,
si fabö'ö'bö'ö ero waêa. Ba bulu geu fangorifi andrö
ba no sitobali wangorifi fefu soi ba guli danö.

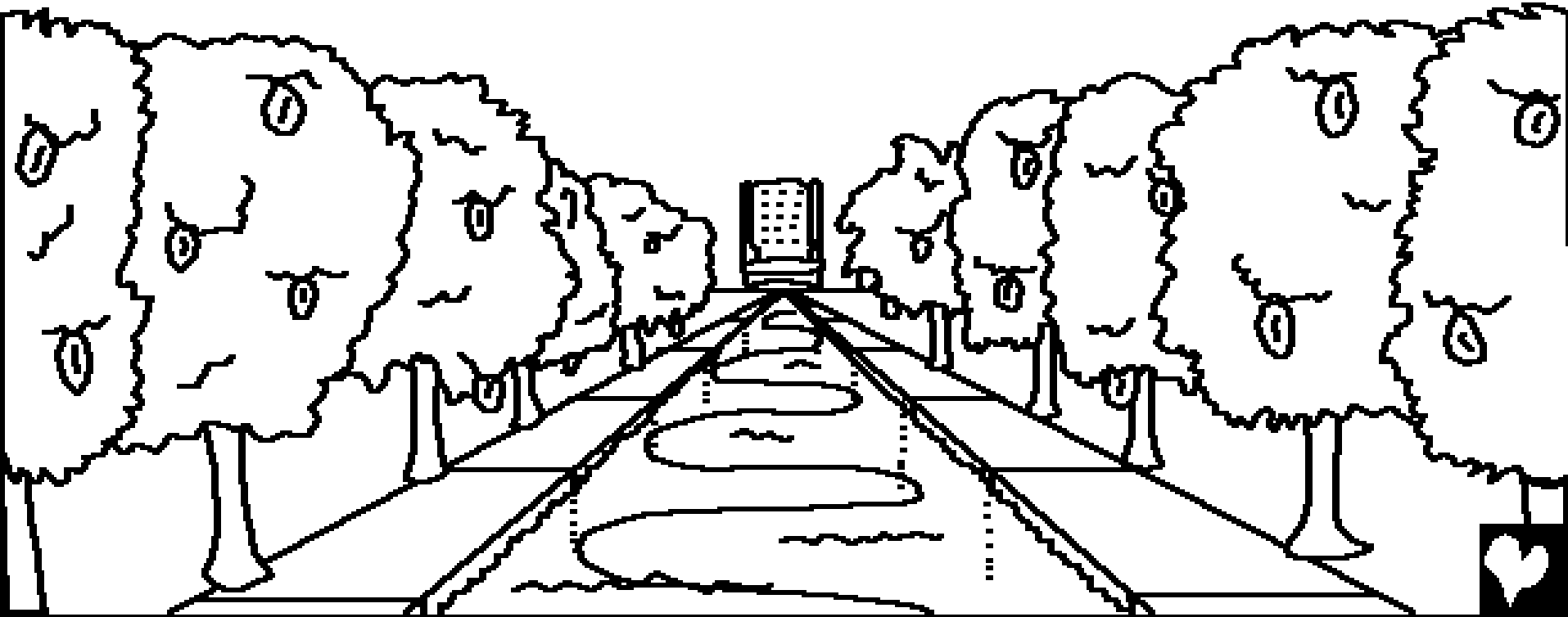

Ba sorugo andrö ba lö moguna haga luo ba ma haga
baŵa sohagaini. Ba no lakhömi Lowalangi andrö
sohagaini. Irege lö zi bongi ba da'ö.

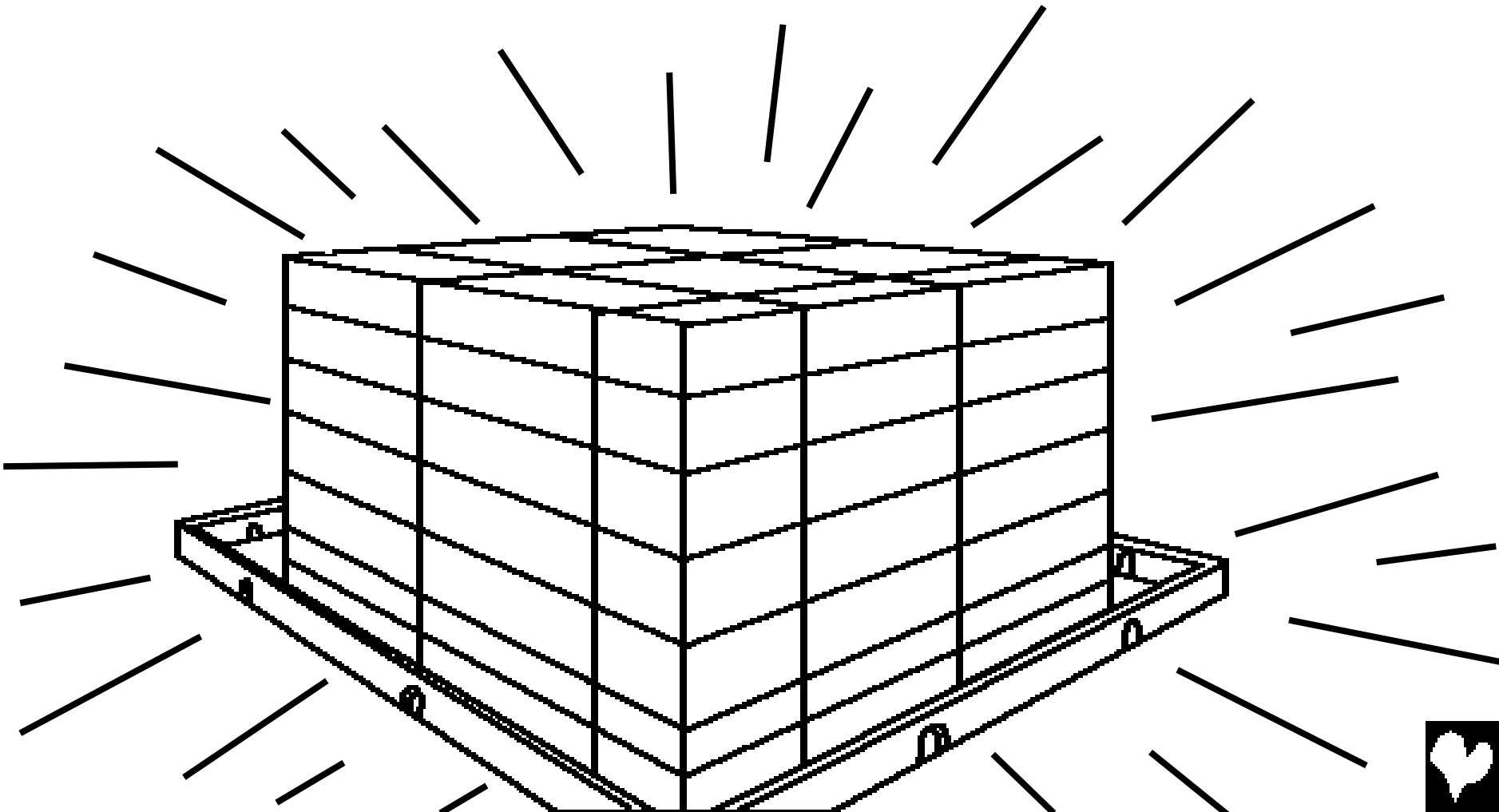

Ba no fabö'ö gurifö si so ba zorugo andrö. No gurifö sifahuwu si so ba da'ö. Asu gatusa ba orudu la'a ndrö'u ba biribiri. Ba simanö zingo ba lö mamakiko gofu hadia ia si so ba hili Ni'amoni'ö andrö khö Yehowa.

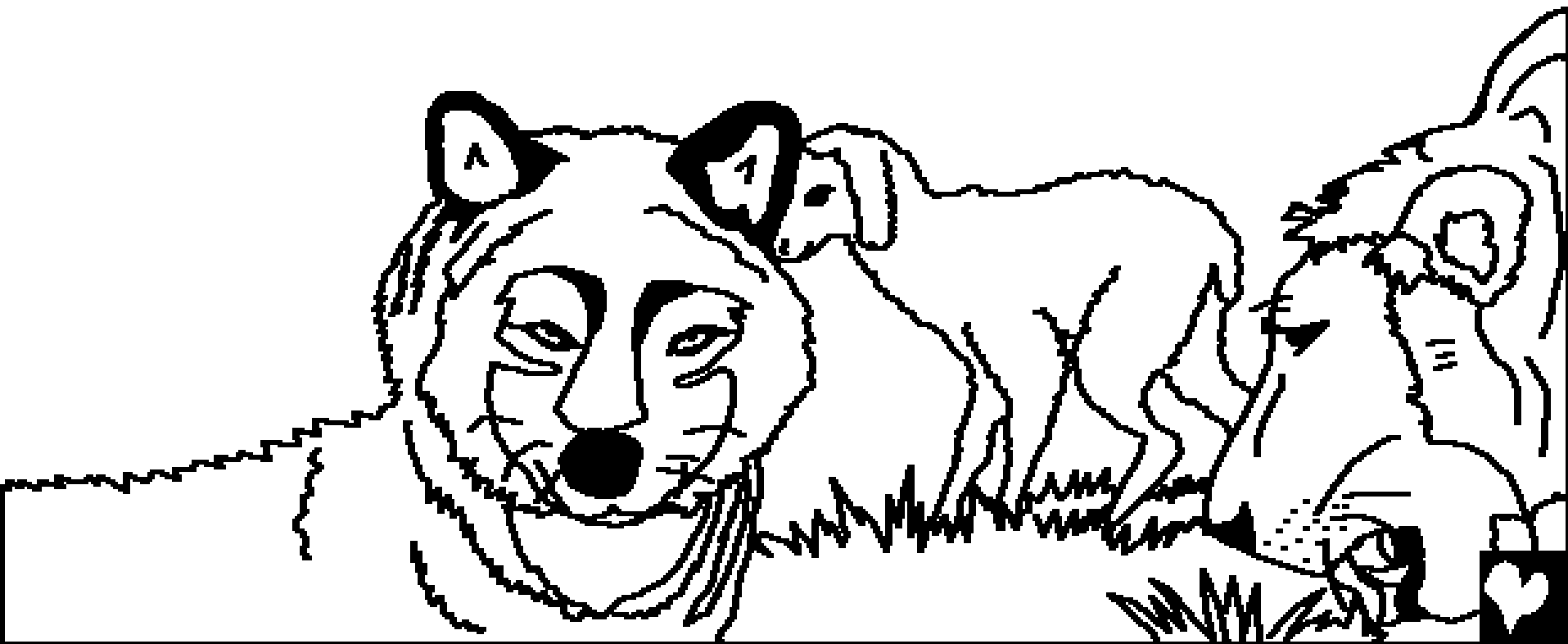

Simane si no aboto ba dödöda, me no te'ombakha'ö
khöda, wa lö hadöi so'amböta ba zorugo andrö. Lö
hadöi sofönu'fönu,
lö sifa'udu,
ba ma so
angeraigö
khönia
manö.

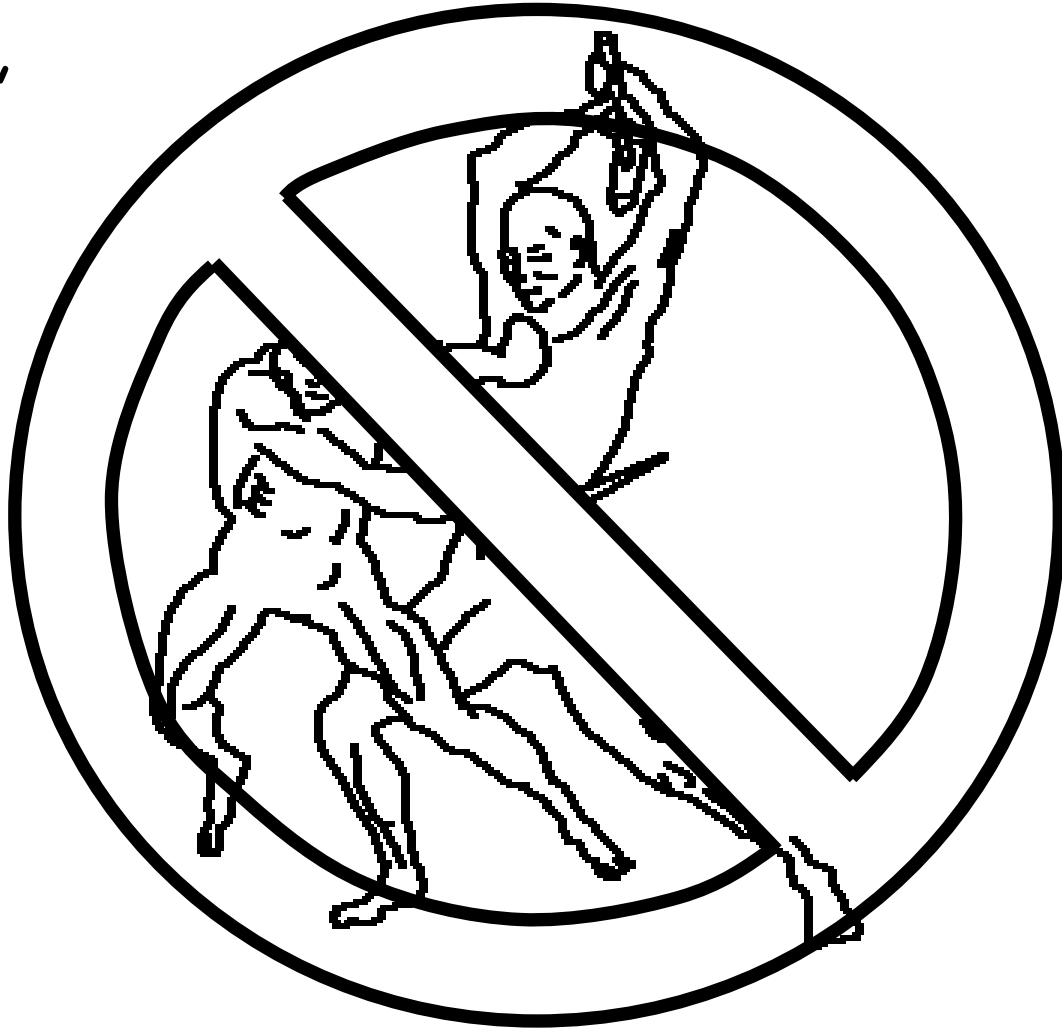

Lö moguna nono kusi bawandruhö, börö me lö sanagö
ba zorugo. Lö sifalimo, samunu niha, ba lö niha si lö
sökhi amuata. Lö
samalua horö
ba zorugo
andrö.

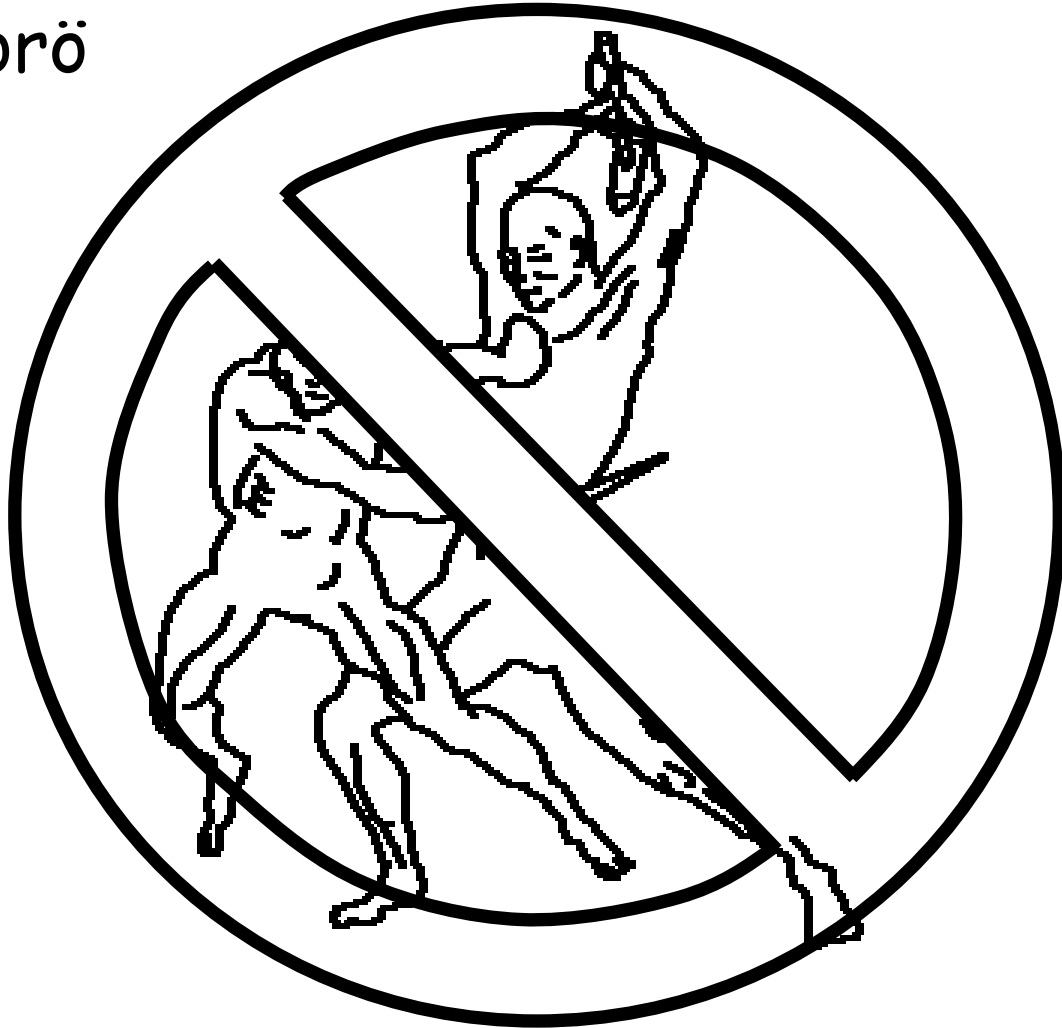

Ba zorugo ba zi so
Lowalangi andrö ba lö
taûa hörö. Itaria niha ba
gulidanö andrö ba alua
we'e börö wa'abu dödöra.
Ba ba zorugo, iheta daûa
hörö andrö Lowalangi.



Ba da'ö lö tesöndra wa'amate. Niha samati nifotöi nono Lowalangi fao khö Lowalangi irugi wa'ara. Lö fa'abu dödö, lö se'e, lö fa'afökhö, lö sangalui dana khönia, lö hadöi lewatö. Dozi si so ba zorugo ba no somuso'muso tödö me fao'fao khö Lowalangi.



Si sökhi ba niha andrö, ba no sorugo andrö he ba ndra matua ba he ba ndra alawe ba zamati khö Yesu Keriso sitobali sangorifi ba wa'aurira ba ni'o'öra li ba khö Lowalangi. Ba zorugo andrö ba so mbuku nifotöi mbuku wangorifi nono biribiri. Ba

afönu töi niha mbuku andrö.

Hadia ö'ila töi niha ni sura

ba da'ö? Yaia

niha same'e

fa'aurinia

ba khö Yesu

andrö. Hadia so

döimö ba da'ö?

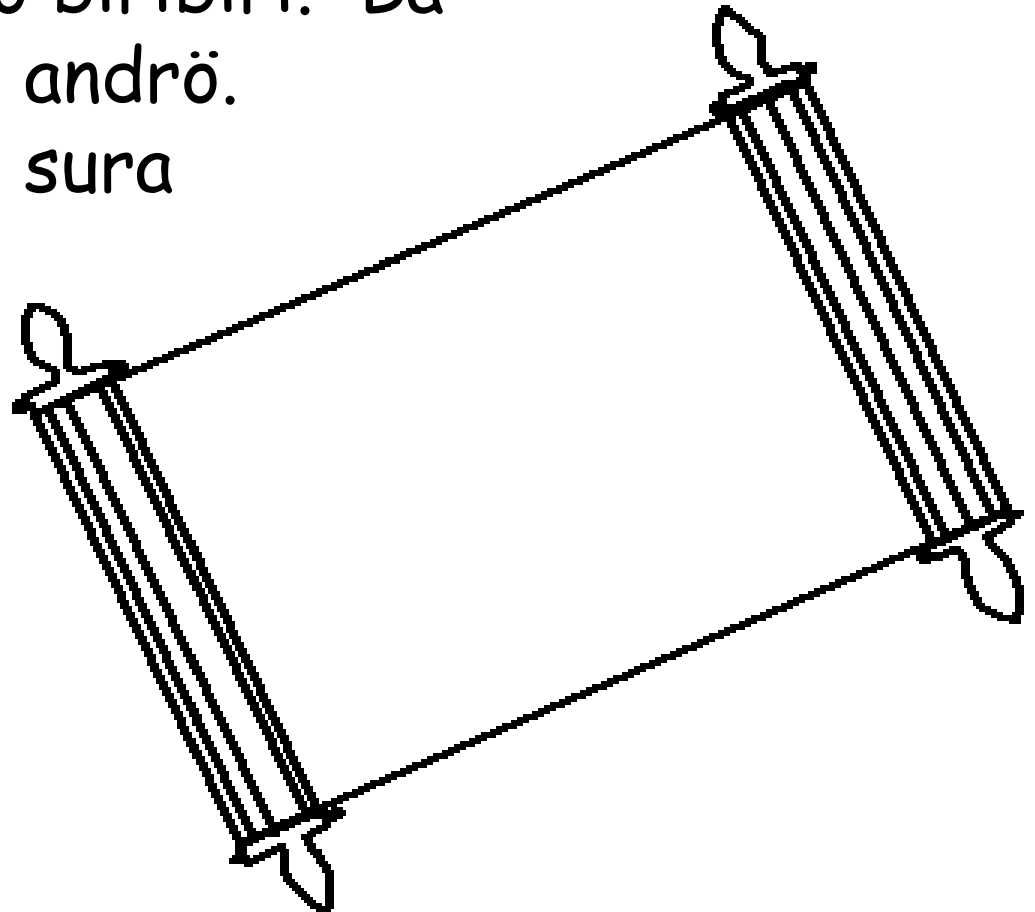

Ba ösi zura safuria si so ba mbuku Taroma li ba no fogaoni. "Ba Geheha Ni'amoni'ö ba Ono Nihalö andrö lamane 'Aine!' Ba niha zamondrongo da'e ba lamane 'Aine!' Ba niha zowökhi tödö, ba yamöi ia! Ba haniha zomasi ba yamuhälö nidanö fangorifi andrö."

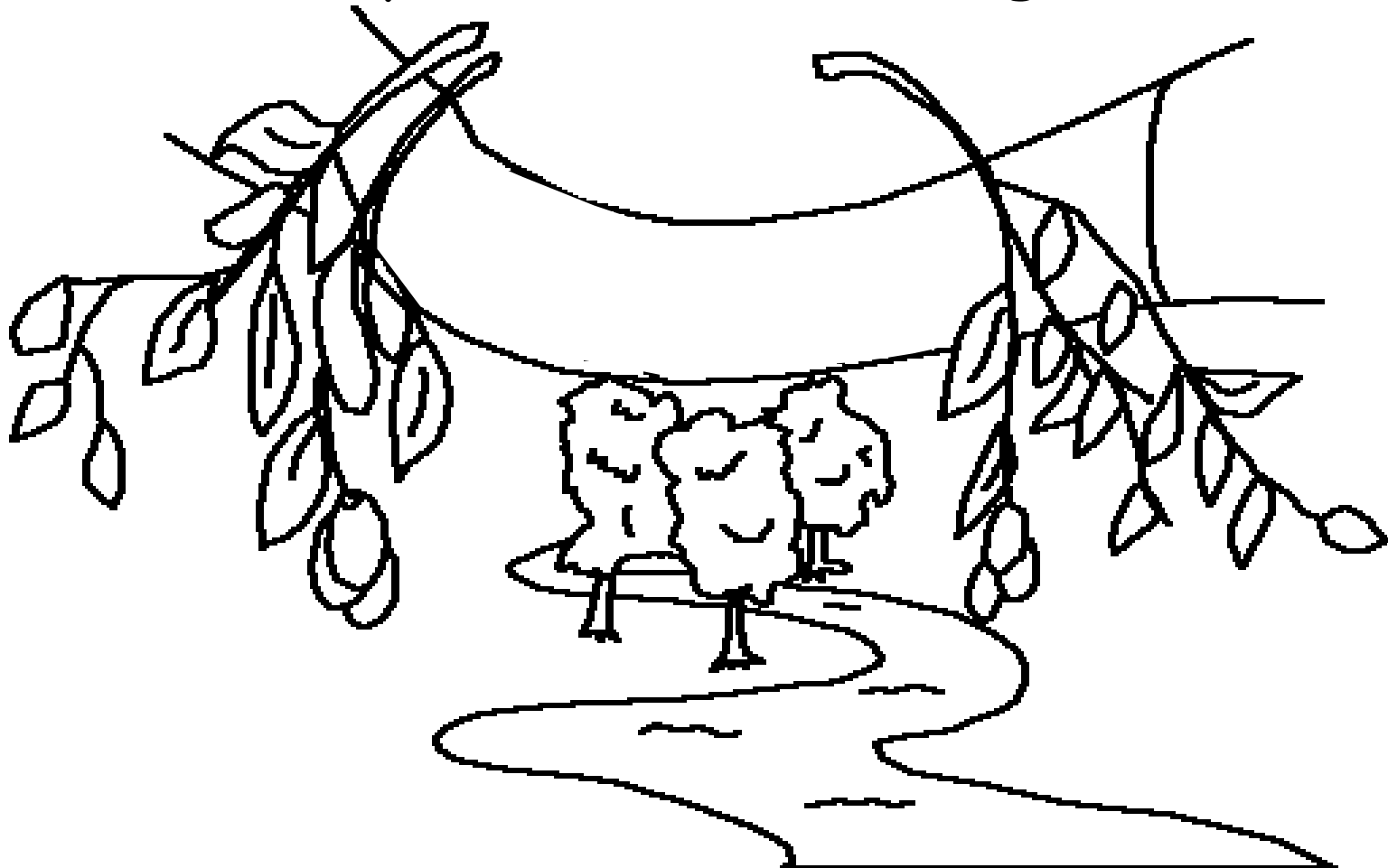

Sorugo, nahia si sokhi sibai

Sambua nidunö'dunö sitobali goroisa Lowalangi

Tesondra ba

Yohane 14, 2 Korindro 5,
Fama'ele'ö 4, 21, 22

"Famahaö Lowalangi andrö ba ibe'e haga."
Sura Sinunö 119:130



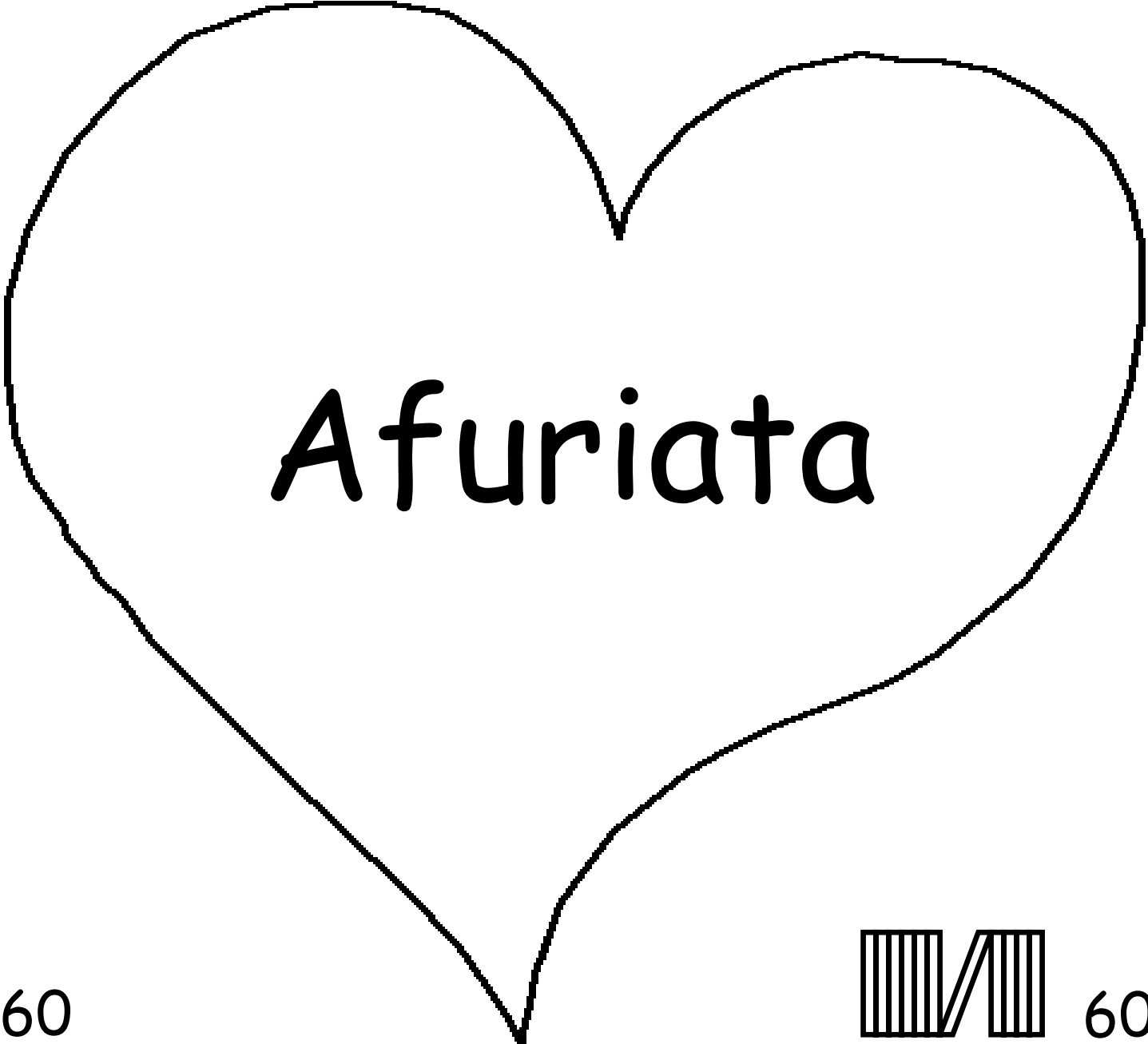

Afuriata

60

60



Ba buku daromali Lowalangi da'a ba te'ombakha'ö khöda wa'abölö
Lowalangi ba wamazökhi yaita ba ena'ö göi ta'ila Ia.

Ba I'ila Lowalangi fefu hadia ia si lö sökhi nifaluada, ba latötöi niha
andrö yaia horö. Ba huku horö andrö ba fa'amate, ba hiza Lowalangi
I'omasiö sibai niha irege Ifatenge nono-Nia si hasamösa, Yesu andrö
mate ba döla röfa ba ni'huku börö fefu horöda. Ba hiza Ifuli maoso
ia ba mangawuli Ia ba zorugo. Ba na faduhu dödömi khö Yesu ba
mi'andrö fangefa ba horömi andrö, ba I'efa'ö. Ba ifuli so dania ba
wa'aurida, ba so wa'auri andrö ba khöNia irege ba zi lo aetu.

Ba na faduhu dödöu ba zura andre, ba ömane khö Lowalangi:
khö Yesu, mamatido khöu wa Zo'aya ndra'ugö ba no tobali ösi niha ba
wa'amate börö horö andrö fefu, ba iada'a ba no auri ia. Ena'ö mi'ae'e
ba wa'aurigu ba efa'ö fefu horögu, irege usöndra fa'auri sibohou, ba
samuza ma'ökhö ba sifao khö Lowalangi irugi zi lö aetu. Ba fasugi
khögu ba wolo'o ba sauri ba khoNia simane nonoNia andrö, yaduhu.

La baso buku daroma li Lowalangi andrö ba fahuhuo
khö Lowalangi seroma'ökhö! Yohane 3:16

