

Buku Taroma li Lowalangi (Ni'amoni'ö) ba ndraono Ni'fa'aso

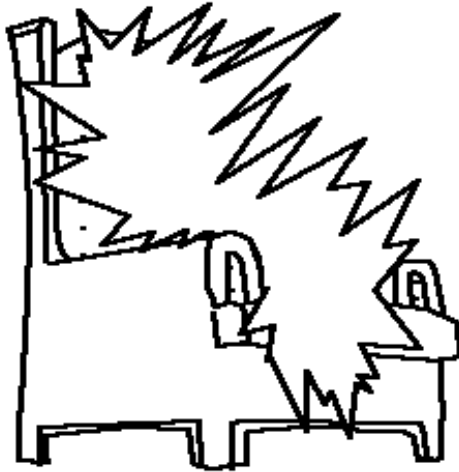

Sorugo,
nahia si
sokhi
sibai



Ni'sura: Edward Hughes
Ni'amaedolagö: Lazarus

Ni'fo'eluha: Dorkas Orienti Daeli
Ni': Bob Davies; Sarah S.

Nidunö'dunö i'otarai 60 irugi 60

www.M1914.org

Bible for Children, PO Box 3, Winnipeg, MB R3C 2G1 Canada

Lisensi: So sitobali dana (hak) ba wango'oya'ö nidunö'dunö andre asala lö lafamawa.

Nias

Me so Yesu ba gulidano ba no I'ombakha'o khora nifahao-Nia sorugo andro. Ifotoi da'o "Nahia Nama-Gu", ba imane ba da'o oya nahia segebua. No ebolo sibai, ba sokhi sibai. Sorugo andro ba no nahia si sokhi moroi ba nomo si so ba gulidano andre.



1

Ba imane Yesu, "Möido ba wama'anö nahia khöu. Ba na no U'fa'anö nahia da'ö ba U'fulido wamaondragö yaugö ba U'ohe ami khögu." Ba mangawuli Ia ba zorugo me no maoso Ia moroi ba ngai zi mate. Ba la'ila da'ö ndra nifahao-Nia. Ba me tefazawa Ia miyawa ba so lawuo solohe Yaia.



2

Ba I'otarai da'ö ba la törö'törö tödöra niha keriso.
 Ba I'wa'ö Yesu si lö mu'ila ginötö we'aso-Nia si lö mudöna'döna. Ba hewisa niha keriso si no mate fatua lö si so Ia?
 Ba no Ifaduhu'ö taroma li Lowalangi wa fao göi ira khö Yesu dania, ba zi so Lowalangi andrö.

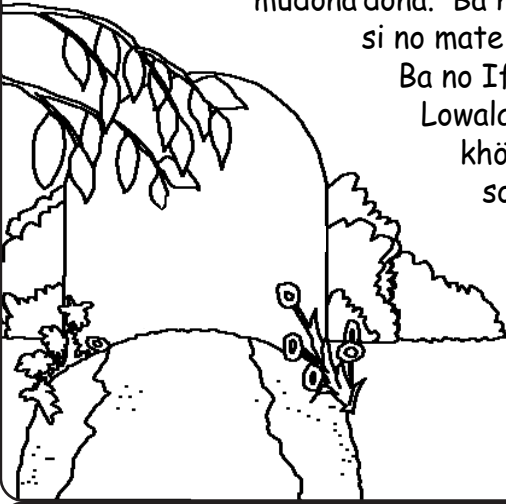

3

Sura wama'ele'ö no sura afuriata ba mbuku daroma li Lowalangi, tefaduhu'ö wa hawa'asökhi zorugo andrö dania. Lö si sökhi baeronia, ba lö famaedo lalania.
 Me sorugo andrö ba no omo Lowalangi. Gofu heza so ba so Lowalangi ba dadaoma-Nia ba ha ba zorugo.

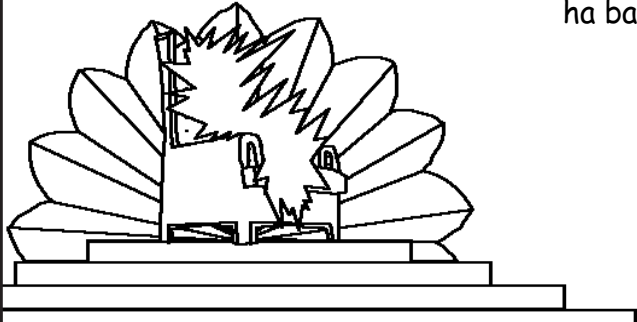

4

Fefu ndra malaika ba zorugo ba oi lasuno Lowalangi. Ba simanö solo'ö Lowalangi si no mate ba gulidanö andre ba zorugo so ira. Ba fefu ira manunö lasuno Lowalangi.

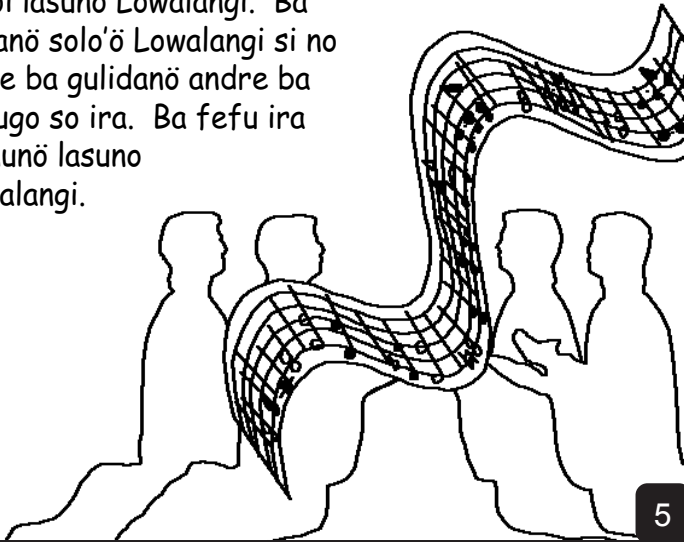

5

Ba la'anunöisi sambua zinuö: Sinangea Ndra'ugö ba wangai buku andrö ba ba wamokai tandrönia.
 Börö me no mutaba Ndra'ugö ba ndro-Mö irege no Öhöli niha khö Lowalangi moroi ba ngawalö mado fefu, ngawalö li ba ngawalö soi ba moroi ba ngawalö niha fefu.
 (Fama'ele'ö 5:9)

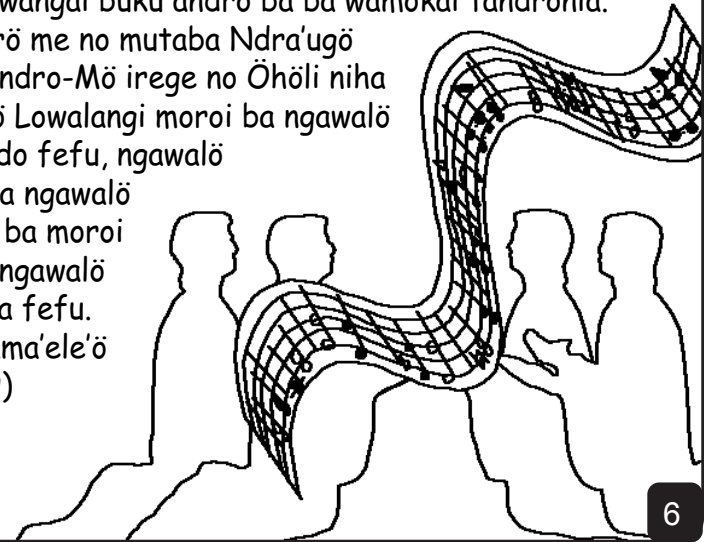

6

Ba nga'örö afuriata ba buku daroma li Lowalangi, te'ombakha'ö khöda zorugo andrö yaia "Yeruzalema sibohou". Ebu ba alawa sibai gölinia. Ba'a'ba'ania ba moroi ba gara safusi si no muhaogö.

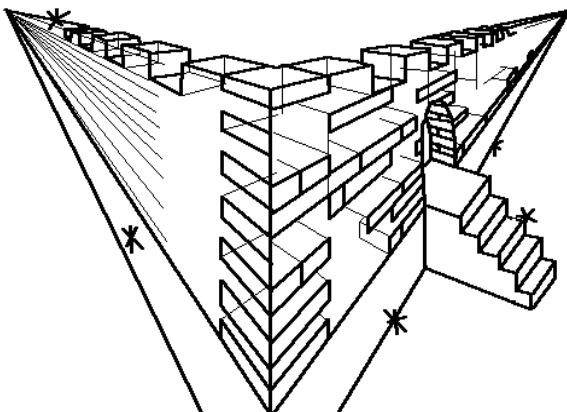

7

Bagolönia moroi ba gara safusi ba si takile. Feremata ba hulö gara baduri sinasa zombalugö danedanenia, oi takile ba oya ngawalö la'a'la'ania si sökhi sibai. Ero bawandruhö mbanua tefazökhi ba manimani sebua böli.

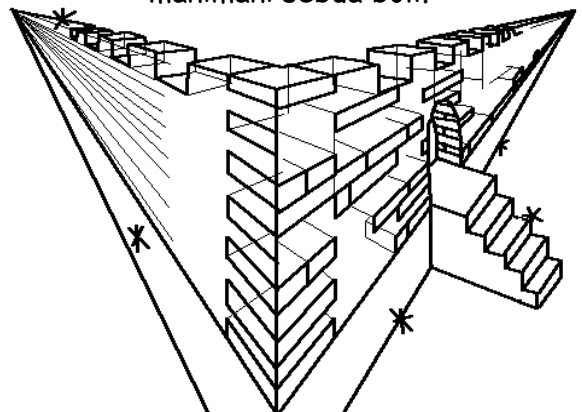

8

Baŵa göli manimani sebua andrö, ba lö irai teduhö. "Mi'aine ba mifaigi" hawa'asökhi yomo, oi moroi ba gana'a si sökhi mane sörömi safusi ba moroi ba gana'a fefu la'a'la'ania.



9

Ba no si sökhi, so nidanö sohahau mangele moroi ba dadaoma Lowalangi andrö. Ba zinga nidanö tanö bö'ö ba so döla geu fangorifi simane si so ba kabu gedena. Tola geu andre ba I'owuaini 12 ngawalö bua, si fabö'ö'bö'ö ero waŵa. Ba bulu geu fangorifi andrö ba no sitobali wangorifi fefu soi ba guli danö.

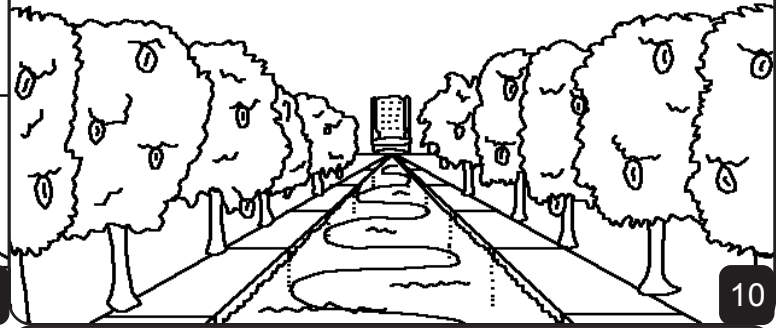

10

Ba sorugo andrö ba lö moguna haga luo ba ma haga baŵa sohagaini. Ba no lakhömi Lowalangi andrö sohagaini. Irege lö zi bongi ba da'ö.

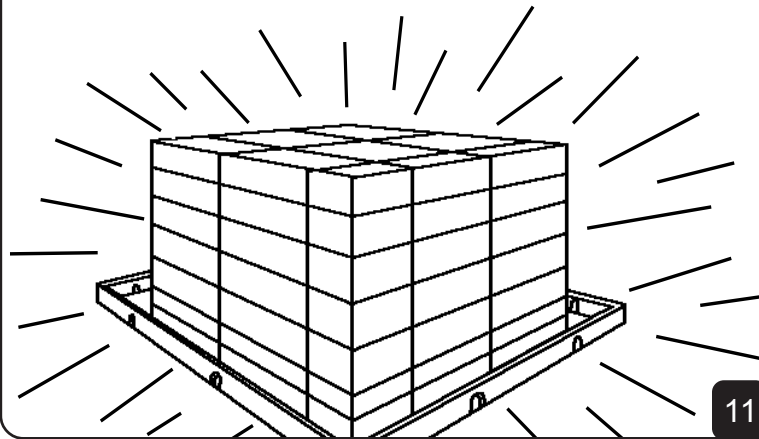

11

Ba no fabö'ö gurifö si so ba zorugo andrö. No gurifö sifahuwu si so ba da'ö. Asu gatua ba orudu la'a ndr'u'u ba biribiri. Ba simanö zingo ba lö mamakiko gofu hadia ia si so ba hili Ni'amonio andrö khö Yehowa.

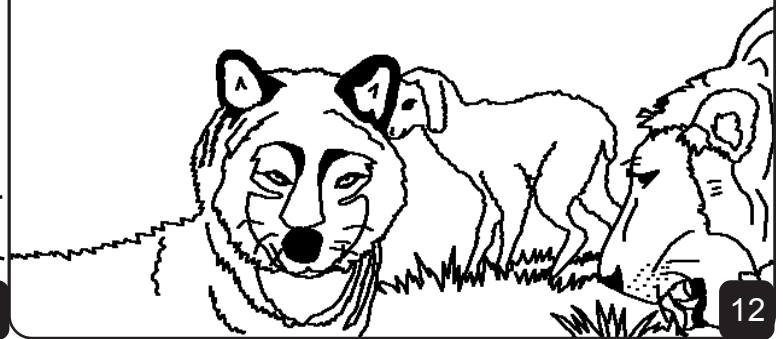

12

Simane si no aboto ba dödöda, me no te'ombakha'ö khöda, wa lö hadöi so'amböta ba zorugo andrö. Lö hadöi sofönu'fönu, lö sifa'udu, ba ma so angeraigö khönia manö.

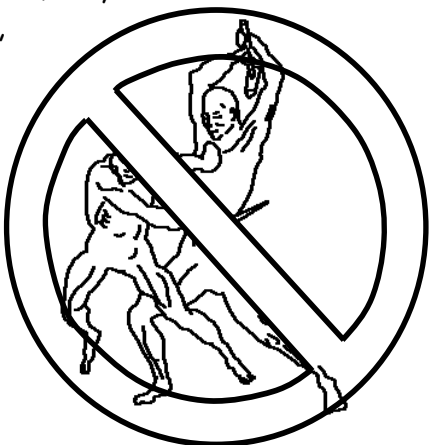

13

Lö moguna nono kusi bawandruhö, böro me lö sanagö ba zorugo. Lö sifalimo, samunu niha, ba lö niha si lö sökhi amuata. Lö samalua horö ba zorugo andrö.

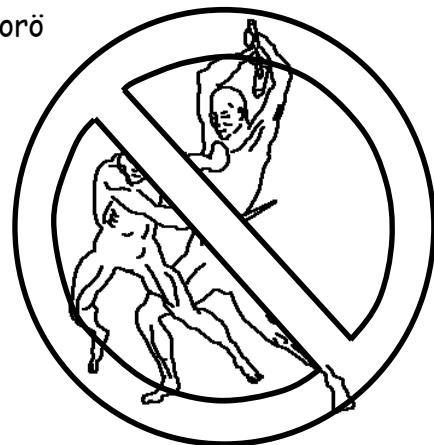

14



Ba zorugo ba zi so Lowalangi andrö ba lö ta'wa hörö. Itaria niha ba gulidanö andrö ba alua we'e börö wa'abu dödöra. Ba ba zorugo, iheta da'wa hörö andrö Lowalangi.

15

Ba da'ö lö tesöndra wa'amate. Niha samati nifotöi nono Lowalangi fao khö Lowalangi irugi wa'ara. Lö fa'abu dödö, lö se'e, lö fa'afökhö, lö sangalui dana khönia, lö hadöi lewatö. Dozi si so ba zorugo ba no somuso'muso tödö me fao'fao khö Lowalangi.



16

Si sökhi ba niha andrö, ba no sorugo andrö he ba ndra matua ba he ba ndra alawe ba zamati khö Yesu Keriso sitobali sangorifi ba wa'aurira ba ni'o'öra li ba khö Lowalangi. Ba zorugo andrö ba so mbuku nifotöi mbuku wangorifi nono biribiri. Ba afönu töi niha mbuku andrö. Hadia ö'ila töi niha ni sura ba da'ö? Yaia niha same'e fa'aurinia ba khö Yesu andrö. Hadia so döimö ba da'ö?

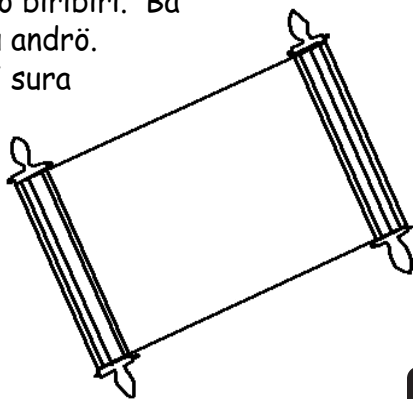

17

Ba ösi zura safuria si so ba mbuku Taroma li ba no fogaoni. "Ba Geheha Ni'amoni'ö ba Ono Nihalö andrö lamane 'Aine!' Ba niha zamondrongo da'e ba lamane 'Aine!' Ba niha zowökhi tödö, ba yamöi ia! Ba haniha zomasi ba yamuhälö nidanö fangorifi andrö."

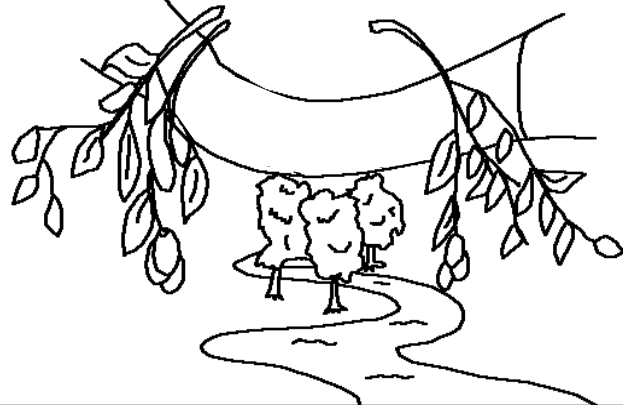

18

Sorugo, nahia si sökhi sibai

Sambua nidunö'dunö sitobali goröisa Lowalangi

Tesondra ba

Yohane 14, 2 Korindro 5,
Fama'ele'ö 4, 21, 22

"Famahaö Lowalangi andrö ba ibe'e haga."
Sura Sinunö 119:130



Ba l'ila Lowalangi gofu hadia ia si lö sökhi nifaluada nifotönia horö. Ba huku horo andrö ba fa'amate.

Ba Lowalangi l'omasiö sibai ita irege lfatenge nono Nia andrö Yesu ba wa'amate ba döla röfa ba wamu'a horöda niha ba gulidanö andre. Ba maoso la ba möi yawa ba zorugo! la da'a ba l'efa'ö horöu Lowalangi.

Ba na omasi'ö aefa ba huku horö, ba ömane khö Yesu: Khö Lowalangi, ya'o mamati wa Yesu no mate ba khögu ba ia da'e ba auri la. Edöna te'asogo la ba wa'aurigu ba efa'o fefu horögu, irege usöndra wa'auri sibohou ia da'e, sifaö khö Nama ba zi lö aetu. Yohane 3:16

La baso buku daroma li Lowalangi andrö ba ena'ö so inötö fahuhuo khö-Nia sero'ma'ökhö!