

Alkitab keu aneuek-aneuek  
Jipeuseumah lé

Yunoeh dan  
Eungköt  
Rayeuek



Jitoeléh lé: Edward Hughes

Jiconto lé: Jonathan Hay  
Alastair Paterson

Jipeujelah lé: Mary-Anne S.

Ji-aréetikan lé: Ernawati

Jipeugèt lé: Bible for Children  
[www.M1914.org](http://www.M1914.org)

©2024 Bible for Children, Inc.

Lisensi: Droen jeuet copy atauwa ceutak calitra nyoe,  
asei droen hana geupubloe.



Bak jamén dillé, ji Israel na sidroe  
ureuëng agam nan jih Yunoeh. Bak sie  
uroe, Tuhan beufiereuman bak  
jih keu geujak u Niniwe,  
saboeh banda nyang  
teurayeuek  
dan paleueng

ramée  
ji Donya  
bak watée  
nyan.

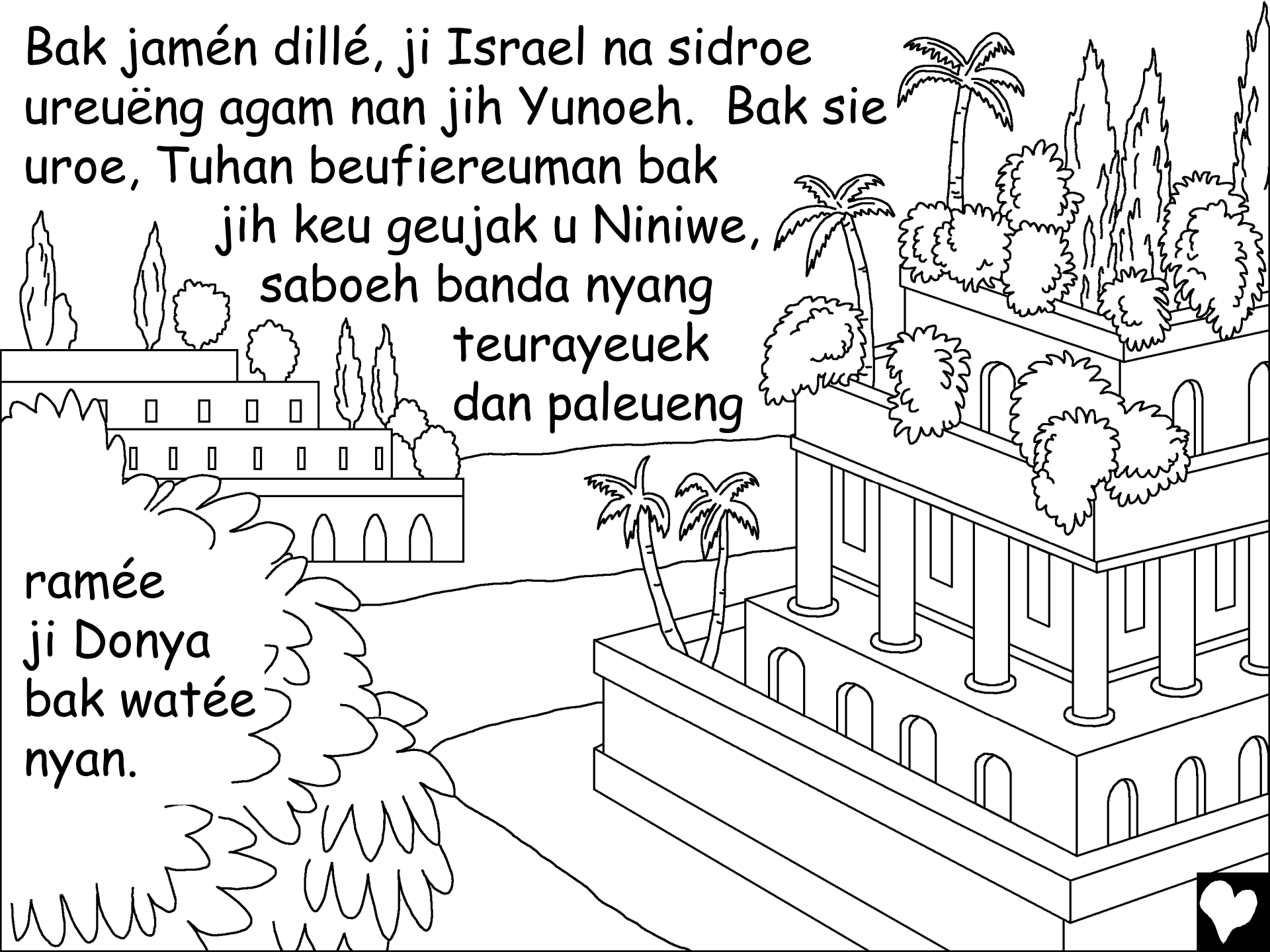

Yunoeh harôh geupeuringat  
kheueh ureuëng-ureuëng ji sidéh  
bahwa Tuhan geuteupeu beutapa  
meudesya jih awaknyan.

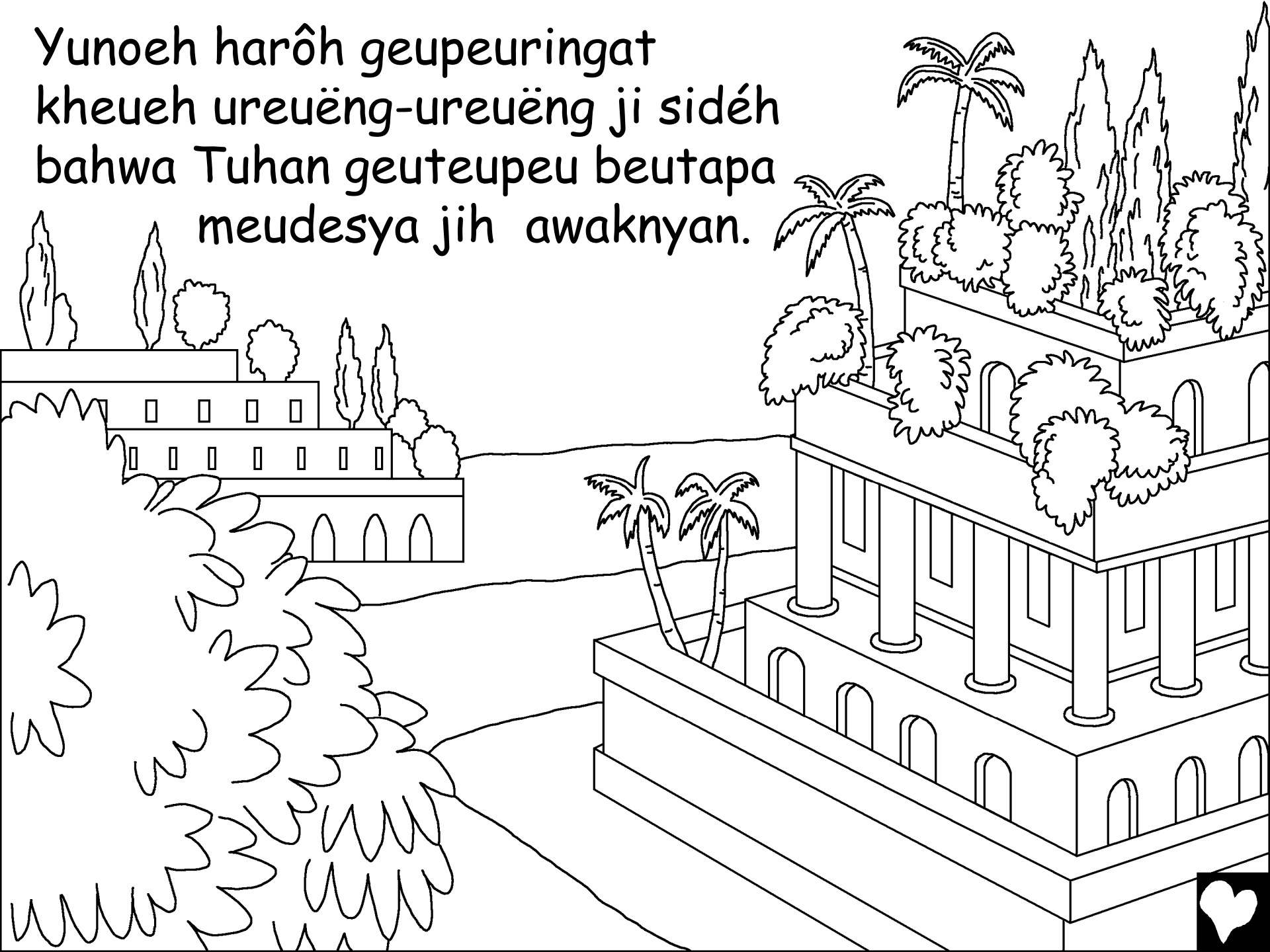

Teuma Yunoeh hana geupatoeh  
peurintah Tuhan! Bukoen jih  
geujak u Niniwe, geuhnyan malah  
geuplueng droe geutumpang  
saboeh kapai u arah nyang jiôh  
dari Niniwe geutujoe u saboeh  
teumpat nyang nan jih Tarsus.



Tuhan óh lheueh nyan geukirém angén taupan dan badée u laôt. Para awak kapai ji ateueh kapai nyang ji ék lé yunoeh jeuet teumakoet, kalau-kalau kapai hancou dan lam.

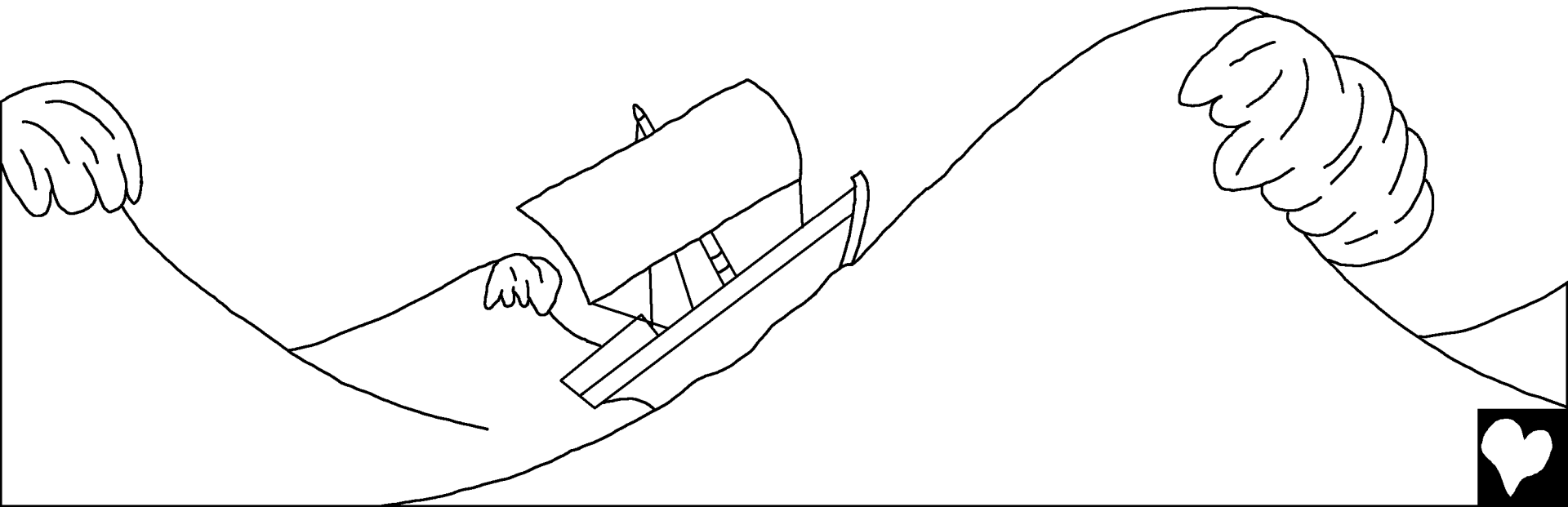

Badée ngon angén seumakin meutamah rayeuek dan keuncang. Seubab keuteumakoet, para awak kapai geumulai meudoá bak deuwa-deuwa awaknyan dan geuboeh banmandum barang-barang dari ateueh kapai keu geupeupui kapai. Teuma hana beuhasé meureuda badée.



Yunoeh sidroe droe jih peunupang ji ateueh kapai nyang hana meudoá. Geuhnyan malahan teungoeh teungeuet ji dek paléng yueb lam kapai. Nahkoda kapai teuka meureumpôk jih. "Hey... peu nyang gata peugeuet? Teungeuet? Jak beudoeh! Meudoá kheueh bak Tuhan gata! Mungkén Tuhan keuneuek geugaséh geutanyoe, seuhingga geutanyoe hana jibinasa."





Para awak kapai pieh mulai geutudoeh Yunoeh seubagoe peunyebab kapai awaknyan jiseurang badée. Yunoeh geupeugah bak awaknyan bahwa meumang geuhnyan geuplueng dari peurintah Tuhan.

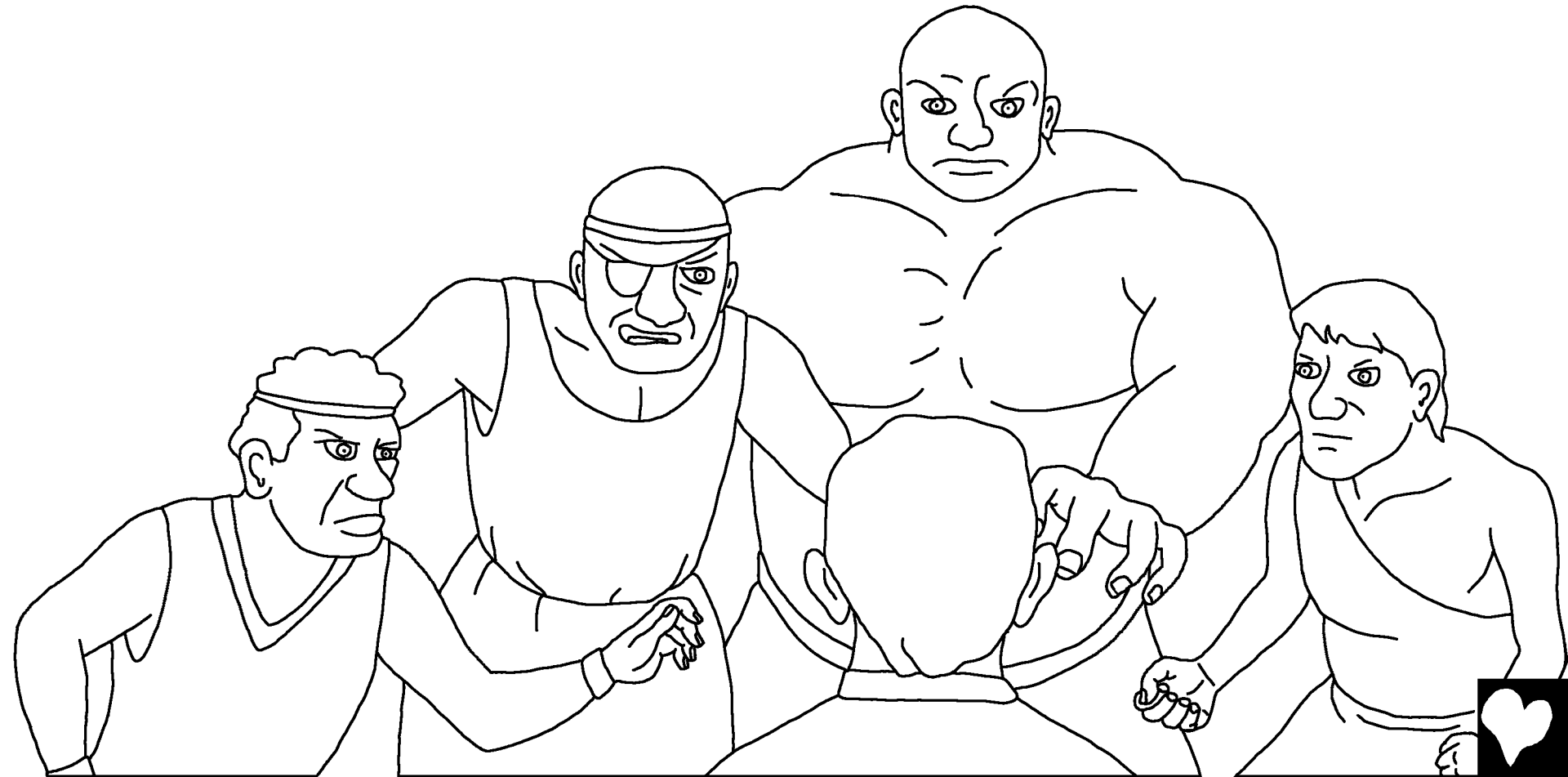

Awaknyan geutanyoeng, "kalau lageu nyan, peu nyang harôh awaknyan peugeuet teuhadap jih keu geureuda badée nyan?" geuJaweueb Yunoeh, "Beuôt kheueh ulôen dan boh u laöt! Seubab ... ulôen". Yakén badée nyoe teujadi seubab keusalahan ulôen.

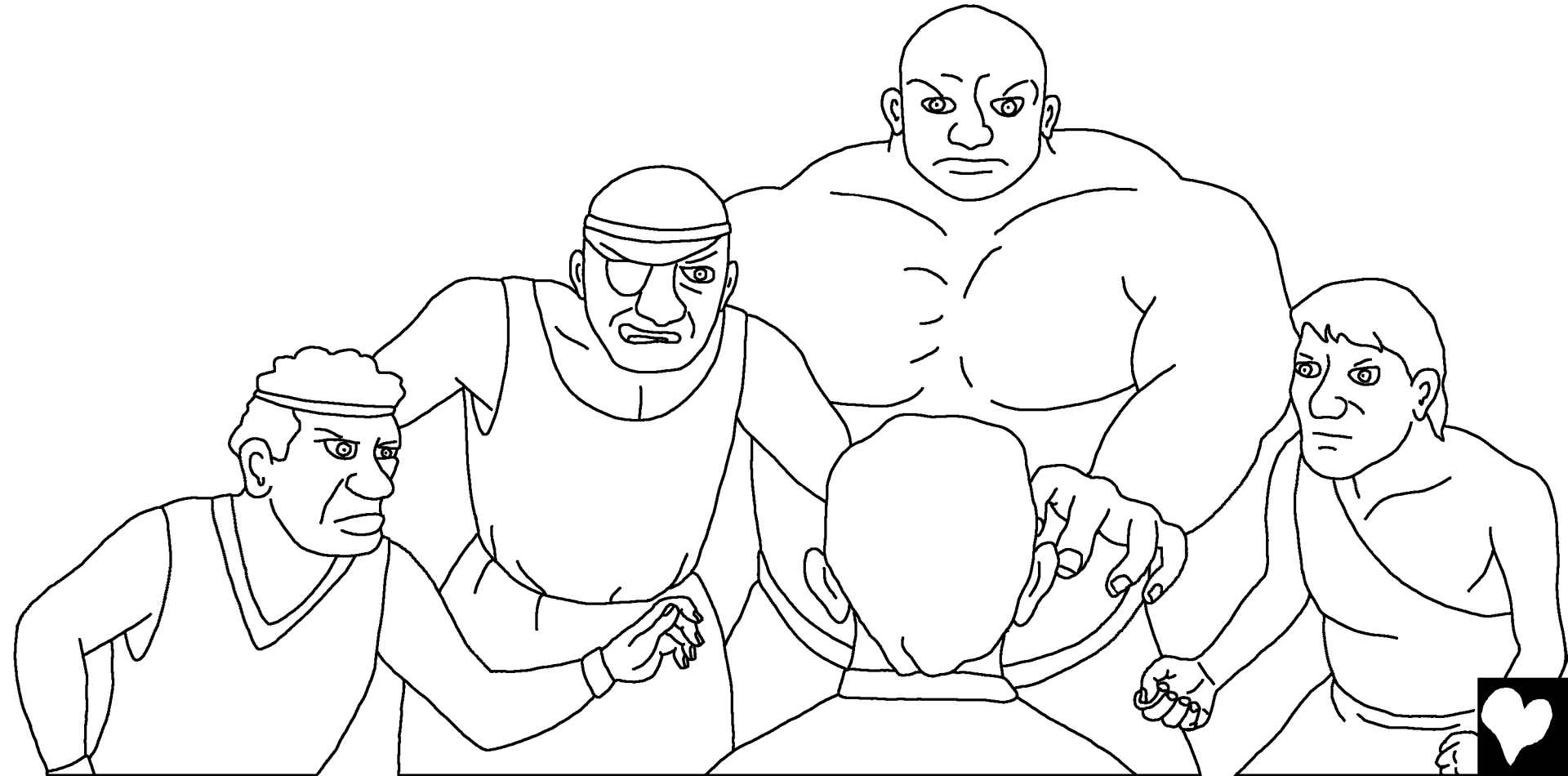

Para Awak kapai hana  
keupingien geupeurôt  
Yunoeh u laöt. Óh  
Iheueh nyan awaknyan  
geukayouh sekuat  
teunaga keu geuarah  
kheueh kapai u arah  
darat. Teuma  
awaknyan hana  
mampu. Cuma  
tinggai saboeh  
hai nyang

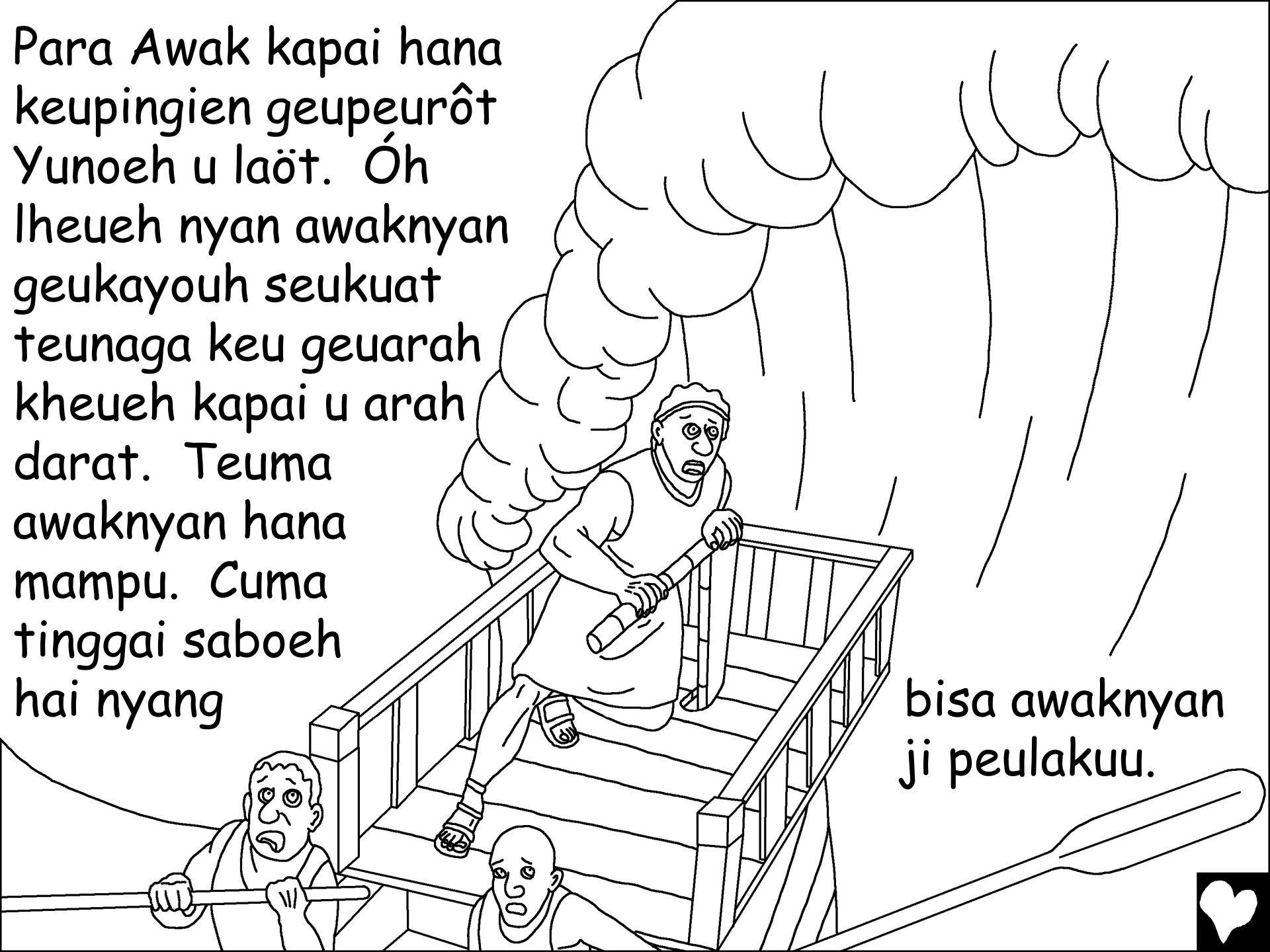

bisa awaknyan  
ji peulakuu.



Óh kalheueh meudoá peumponan, awak kapai  
lajúu geubeuôt Yunoeh u ateueh  
dan geuboh jih  
u laöt. Lajúu  
óh lheueh  
Yunoeh gadôh  
ji út geulumbang,  
deungon hana jisangka  
laöt luwah jeuet teunang  
dan badée geupiôh.

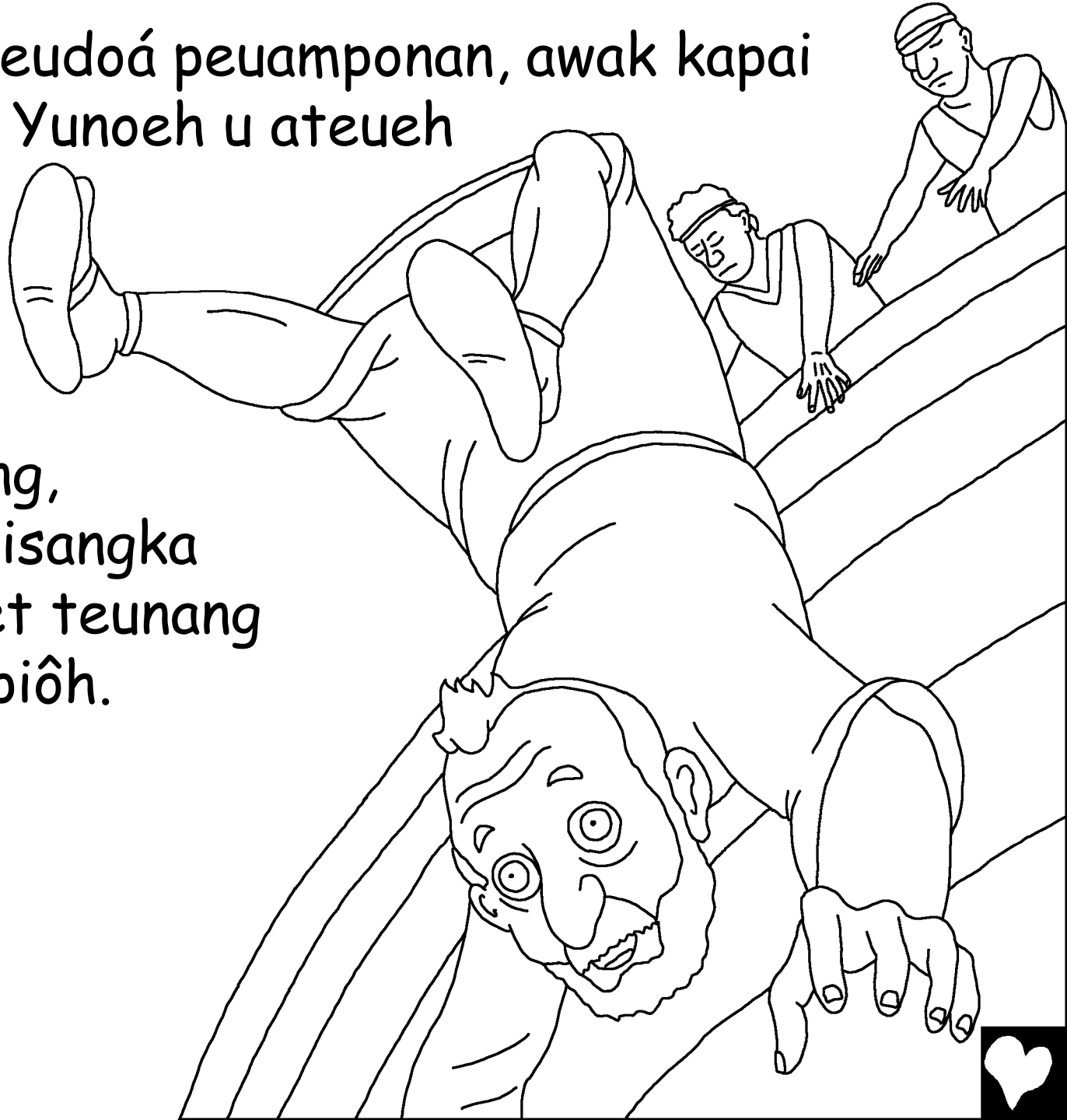

Peubahan cuaca nyang bagah that  
nyan jipeugeuet teumakoet para  
awak kapai,  
leubheueh  
teumakoet  
dari pada  
badée nyang baroe  
mantong gadoeh. Awaknyan  
sadar bahwa Cuma Tuhan  
nyang sanggôp geupeugeuet  
nyan. Lam teumakoet  
dan takjôb, awaknyan  
geupujoe-pujoe Tuhan.

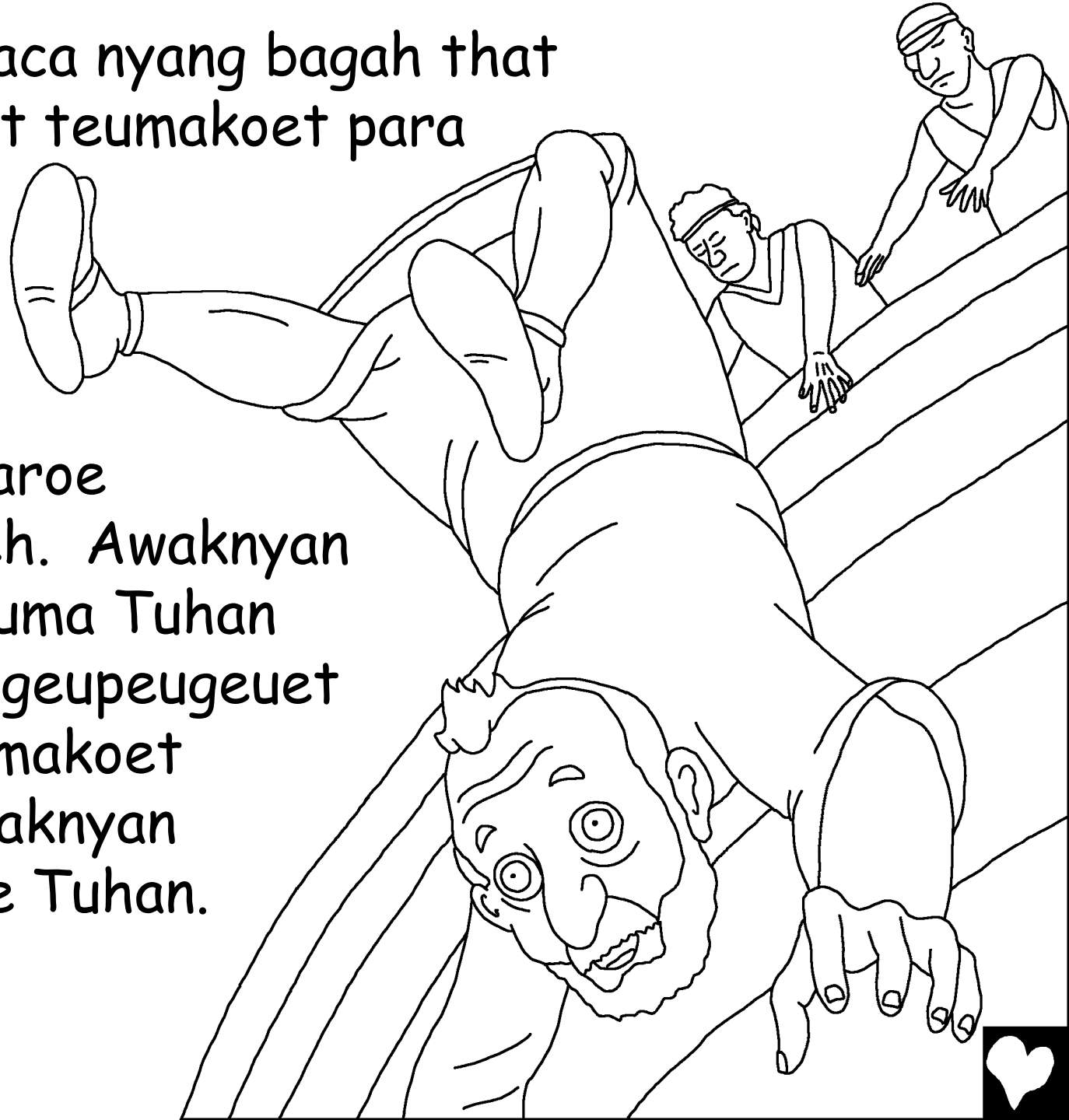

Seumeuntara nyan,  
si utösan (Yunoeh)  
nyang hana geutaát  
peurintah Tuhan  
geualami saboeh  
keujôtan rayeuek.  
Hana beudaya teulam  
ji keudalaman laöt  
raya, Yunoeh sadar  
bahwa hana  
meusidroë nyang  
bisa geutuloeng jih  
lée. Geuhnyan keuneuek  
maté lam, teuma Tuhan na  
reuncana-reuncana laén keu jih.

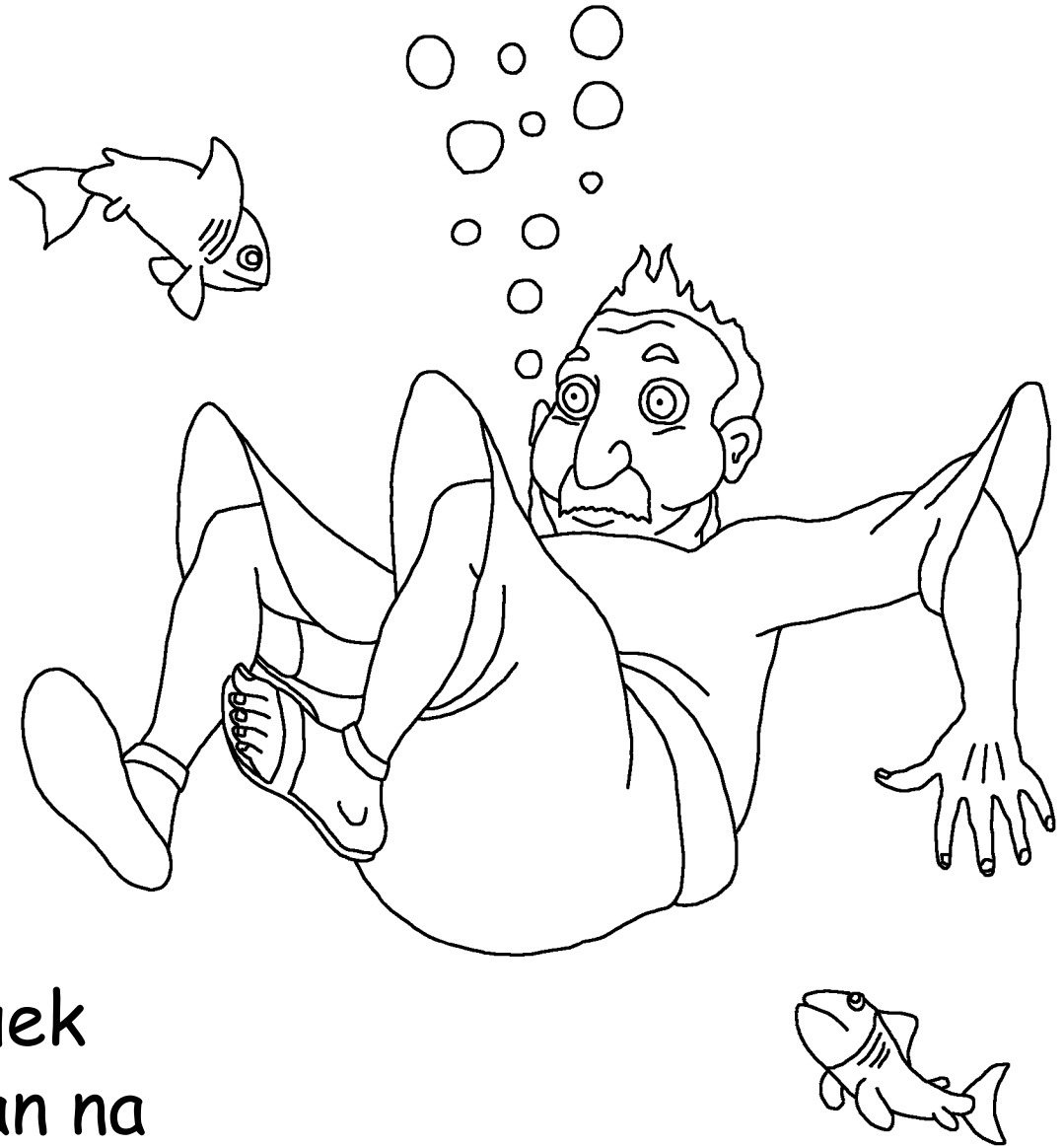

Tuhan ka geupeusiap kheueh saboeh eungköt rayeuek keu geu ût Yunoeh. Eungköt rayeuek teuka teupat bak watée jih! Dan lam sigô áp, Yunoeh ji ût dan tamoeng u lam pruet eungköt rayeuek nyan. Yunoeh tinggai ji lam pruet eungköt seulama lhee uroe. Geuhnyan na lée watée keu meureunung dan meudoá.

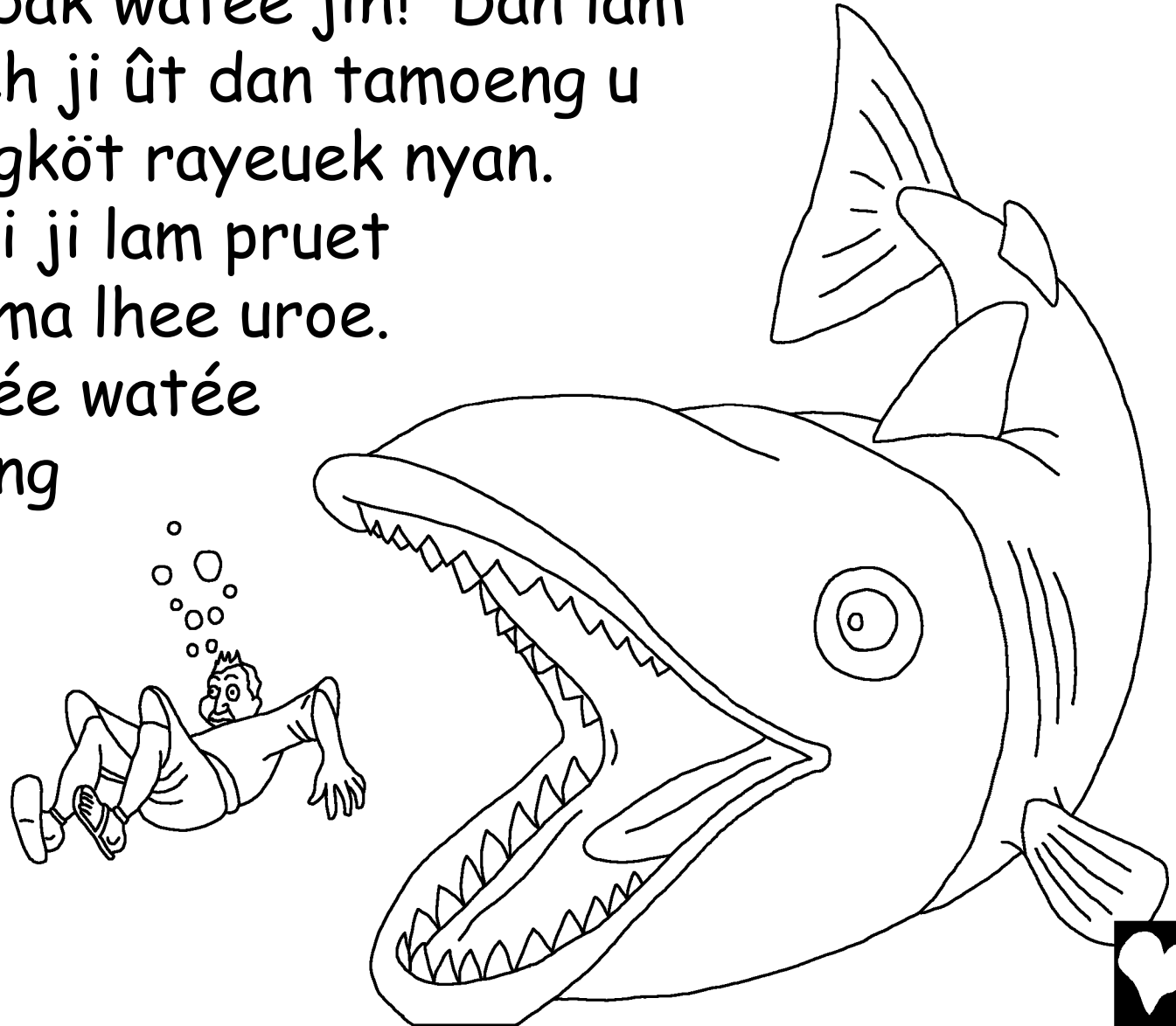

Óh kalheueh lhee uroe, Yunoeh akher jih meujanjie  
keu geupatoeh peurintah Tuhan. Óh lheueh nyan  
Tuhan geupeurintah eungköt rayeuek, keu  
geupeumuntah Yunoeh ji bineueh pasie.

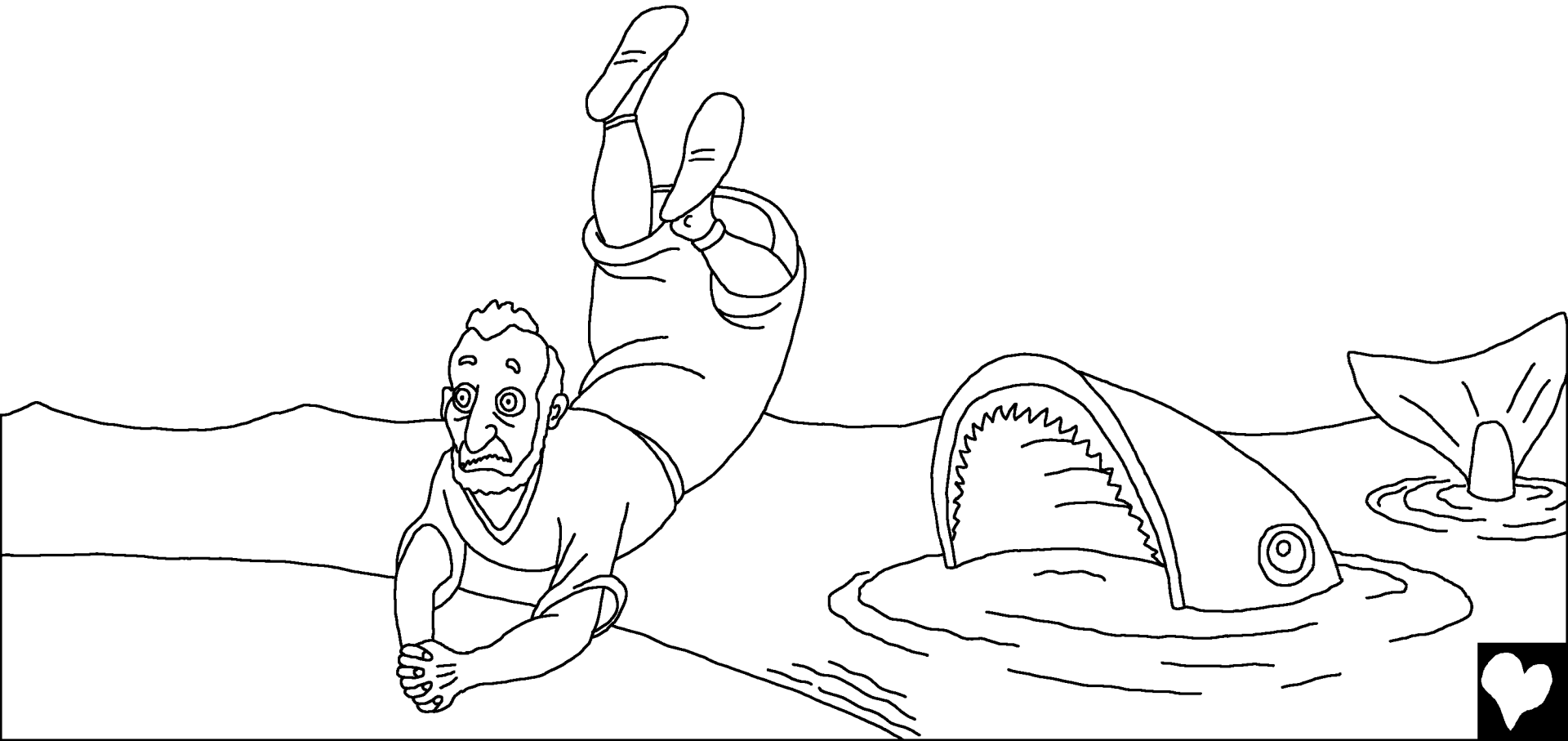



Si gô theuek, Tuhan geupeurintah Yunoeh keu geujak u Ninniwe dan geupeurunoe Fiureuman Tuhan. Si gô nyoe, Yunoeh patoeh dan geujak u Niniwe. Yunoeh troek u banda Niniwe dan geupeukabáa kheueh, "Bahwa lam peuet ploeh uroe, Niniwe keuneuek ji peuhancoe."



Rakyat Niniwe peucaya teuhadap peuringatan dari Tuhan. Awaknyan beupuasa dan geupakék pakaian beukabông keu geumohon ampônan ateueh desya-desya awaknyan bak tuhan. Bahkan raja awaknyan pieh geupeureundah droe ji keu Tuhan. Geuhnyan geuploeh mahkota jih, geupakék pakaian beukaboeng dan geuduek lam abée.

Raja geupeurintah tiep ureuëng keu geubaléék dari keukreah that, dan desya-desya awaknyan

dan meudoá seubab  
Tuhan keuneuek  
geupeuampoen  
awaknyan.

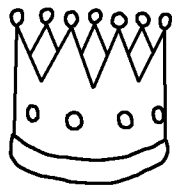

Tuhan beuna-beuna geupeuampoen awaknyan! Nyan  
kheueh uroe nyang paléng meunakjôpkan dan peunoeh  
keuseunangan ji Niniwe watée ureuëng-  
ureuëng geusadar bahwa  
Tuhan kaleueh  
geupeuampoen  
desya-desya  
awaknyan.



... Teuma na sidroe ureuëng nyang keubhiet that beungeueh. Yunoeh!



Pakhoen Yunoeh beungeueh? Geuhnya geupeugah bak Tuhan, "Ulôen teupée bahwa Droeneueh nakheueh Tuhan nyang peunoeh beureukat, dan peumurah, treb jeuet beungeueh, dan peunoeu keujroeh." Deungoen

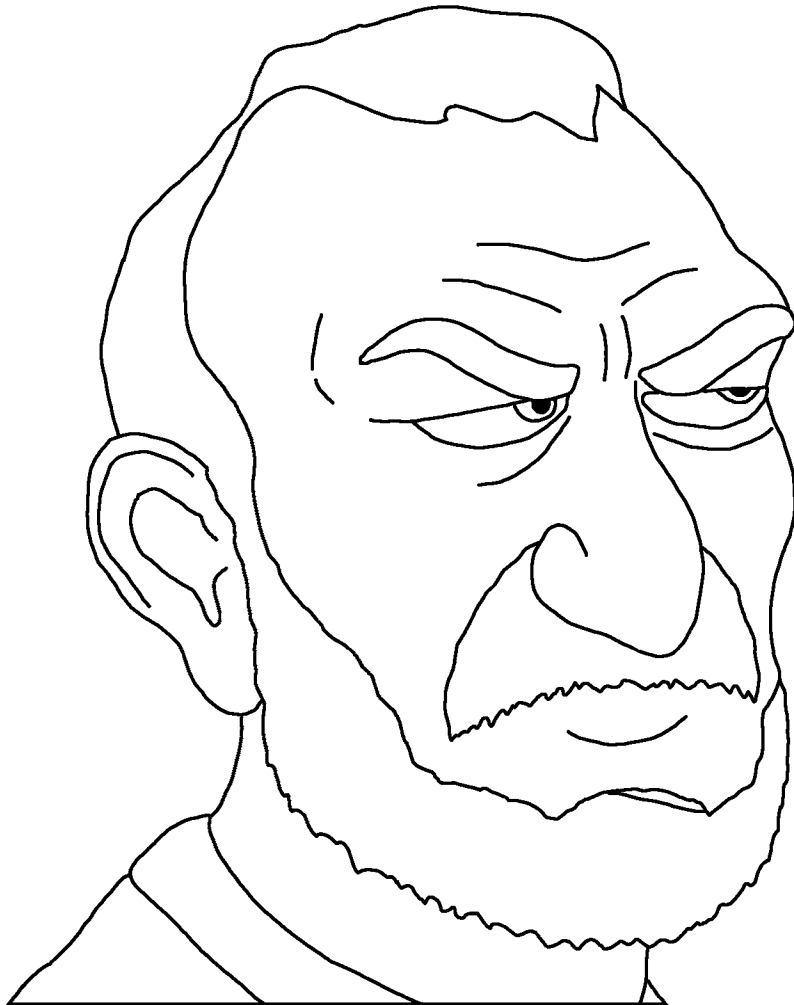

kheuen laen, Yunoeh geusadar droe jih bahwa Tuhan sabée geupeuampoen ureuëng-ureuëng nyang meumohoen ampoen ateueh desya-desya awaknyan dan geupatôh Fiereuman Tuhan. Takaloen Yunoeh hana seunang kalau Tuhan geupeuampôn rakyat Niniwe.



Yunoeh jeuet keubhiet that beungeueh bak Tuhan dan geukheuen, "Coek kheueh udép lôen; seubab keumaöt leubheueh geuet bagi lôen dari pada keu udép."



Yunoeh geuduek ji luwa banda sambée geupreah  
peu nyang keuneuek Tuhan peugeuet óh lheueh  
nyan. Tuhan ka geupeusiap kheueh saboeh sanaman  
deungon ôn-ôn nyan rayeuek. Sanaman nyan timoeh  
deungon bagah that, dan  
geupeuteuduh kheueh Yunoeh  
dari seu um mata uroe  
seupanyang uroe.



Singoeh uroe jih, beungoeh-beungoeh that, Tuhan geukireuem ulat nyang geupeumatée sanaman nyan. Óh lheueh nyan Tuhan geupeuteuka kheueh angén keuncang dan seu um nyang geuhantam Yunoeh seuhingga Yunoeh beupikée bahwa geuhnyan keuneuek bagah maté. Banmandum hai nyoe geupeugeuet Yunoeh seumakén meutamah beungeueh.

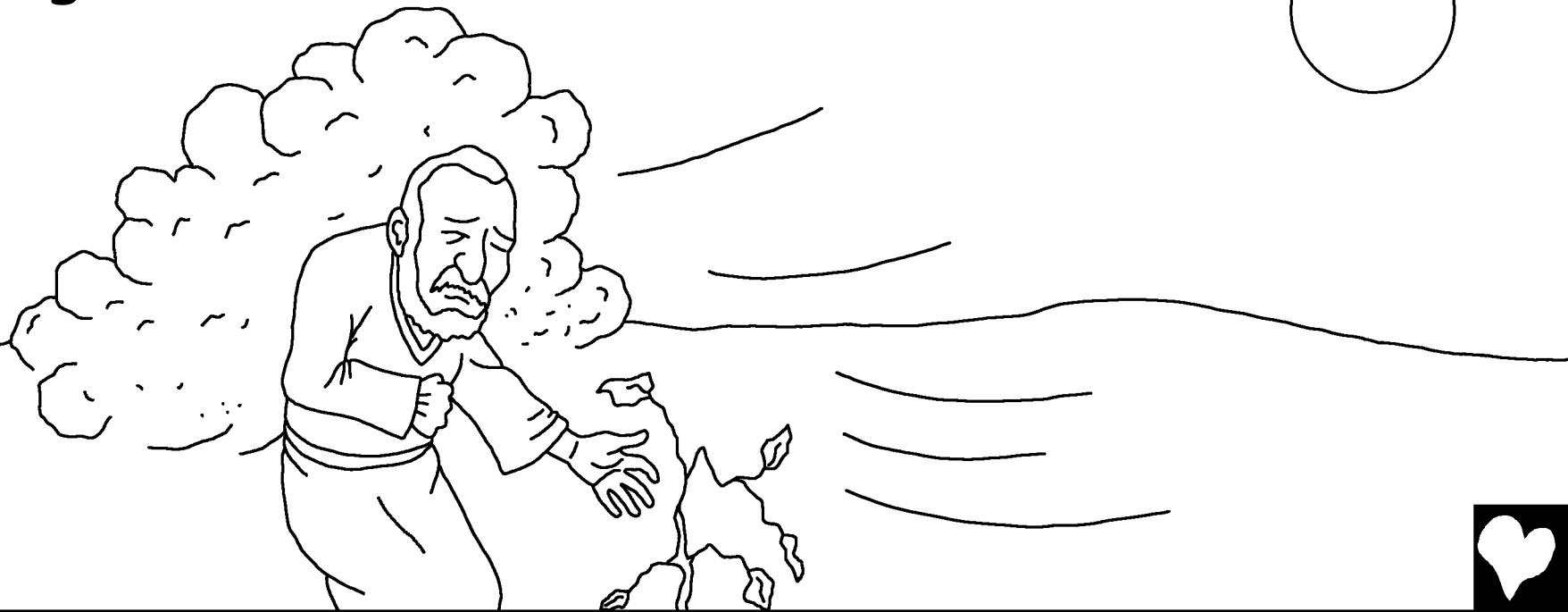



Óh lheueh nyan Tuhan geukheuen bak Yunoeh, "Peukheueh droeneueh na hak keu beungeueh? Droeneueh peuduli deungon bak kayée anggor nyang hana gata tanom dan hana gata peu udép.

Nyan keuneuek na lam seumalam dan maté lam seumalam.

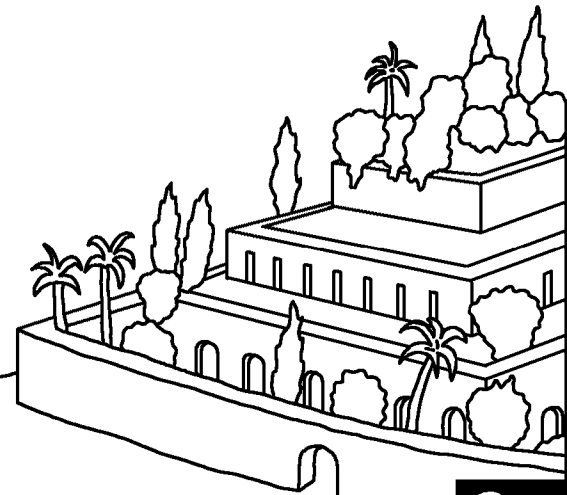
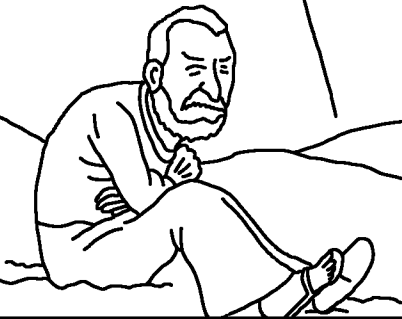

Pakhoen Ulôen han jeuet meumbrie  
Keumurahan-Lôen bak Niniwe, banda  
rayeuek deungon meuribée  
rakyat jih?"



Yunoeh dan Eungköt Rayeuek

Saboeh kisah nibak feureuman Tuhan, Alkitab,  
jiteumeung jidalam

Yunoeh

"Feureuman Droen neujok peunerang."  
Zabur 119:130



Seuleusoe

26

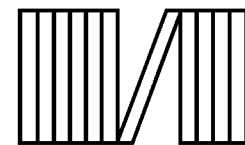

60



Calitra Alkitab jisinoe teukisah bak geutanyoe bhaih Allah Geutanyoe nyang lua biasa jeuet gata thürie-Gobnyan.

Allah geuteupéu geutanyoe ka tapeuget buet-buet nyang jahèt, nyang dipeugah lè Gobnyan desya. Huköm desya na kheueh mawöt, tapi Allah geugaseh that gata, Gobnyan geu-utus Aneuek Gobnyan nyang sidroe, na kheueh Isa, keu matéé jiateuh kayée saleb dan ji huköm kareuna desya-desya gata, oh lheueh nyan udéb lôm dan ék u syuruga! Meunyoe gata peucaya bak Isa dan geulakée peuamphonan Gobnyan ateueh desya-desya gata, Gobnyan teuma geupeuamphon! Gobnyan teuma trôk dan udéb lam gata dan gata teuma udéb meusajan-sajan ngon Gobnyan seulama jih.

Meunyoe gata peucaya nyoe na kheueh keubeunaran, beudoa lagée nyoe bak Allah: Tuhan Isa, loen peucaya bahwa Droen na kheueh Allah, nyang ka jeaet manusia keu matéé bagi desya-desya uloen, dan jinoe Droen bangkét. Keunoe geutamong u lam udéb loen dan peuamphon desya-desya loen, jeaet loen na udéb nyang baroe, dan saboeh masa jak meusajan-sajan ngon Droen seulamajih. Tuloeng loen keu ta` at bak Droen dan udéb keu Droen sebagoe aneuek Droen, Amin.

Baca Alkitab dan mariep ngon Tuhan tièp uroe! Yahya 3:16

