

Macaafa Qulqulluu Daa'immaniif Dhihaate

Ilma
Waaqayyoo
Tajaajilaa
Saamu'eel



Kan barreeffame: Edward Hughes

Kan ibsame: Janie Forest, Alastair Paterson

Kan dagaagsame: Lyn Doerksen

Kan hiikkame: Zemendale Translation Service
email: zemendale@gmail.com
Po Box 32155, Addis Ababa, Ethiopia

Kan qophaa'e: Bible for Children
www.M1914.org

©2024 Bible for Children, Inc.

Eeyyama: Seenaa kana hamma hin gugurreetti garagalfacuu
ta'ee Maxxansiifacuu ni dandeessu.



Haannaan dubartii gaariin nama gaarii Elqaanaanitti heerumte. Lamaan isaanii Waaqayyoon waaqessuun gaarummaa isaa namoota birootti agarsiisaa turan. Garuu waanti tokko jireenya Haannaa keessaa hir'uu

ture. Mucaa godhachuu barbaaddi. Oh akkamitti mucaa barbaadde! Egeeun kadhatte yeroo baayyee eeggatte. Mucaan hin argamne!

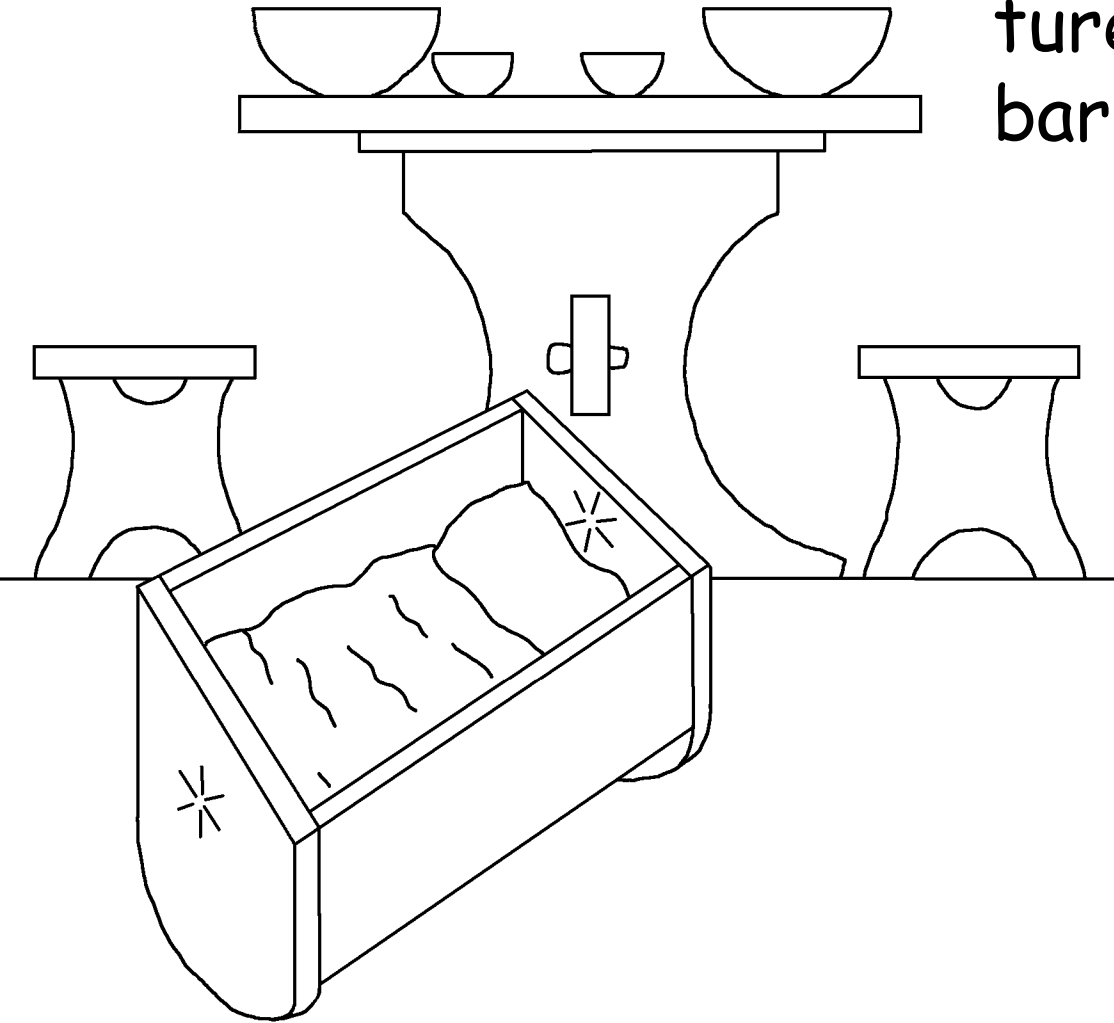

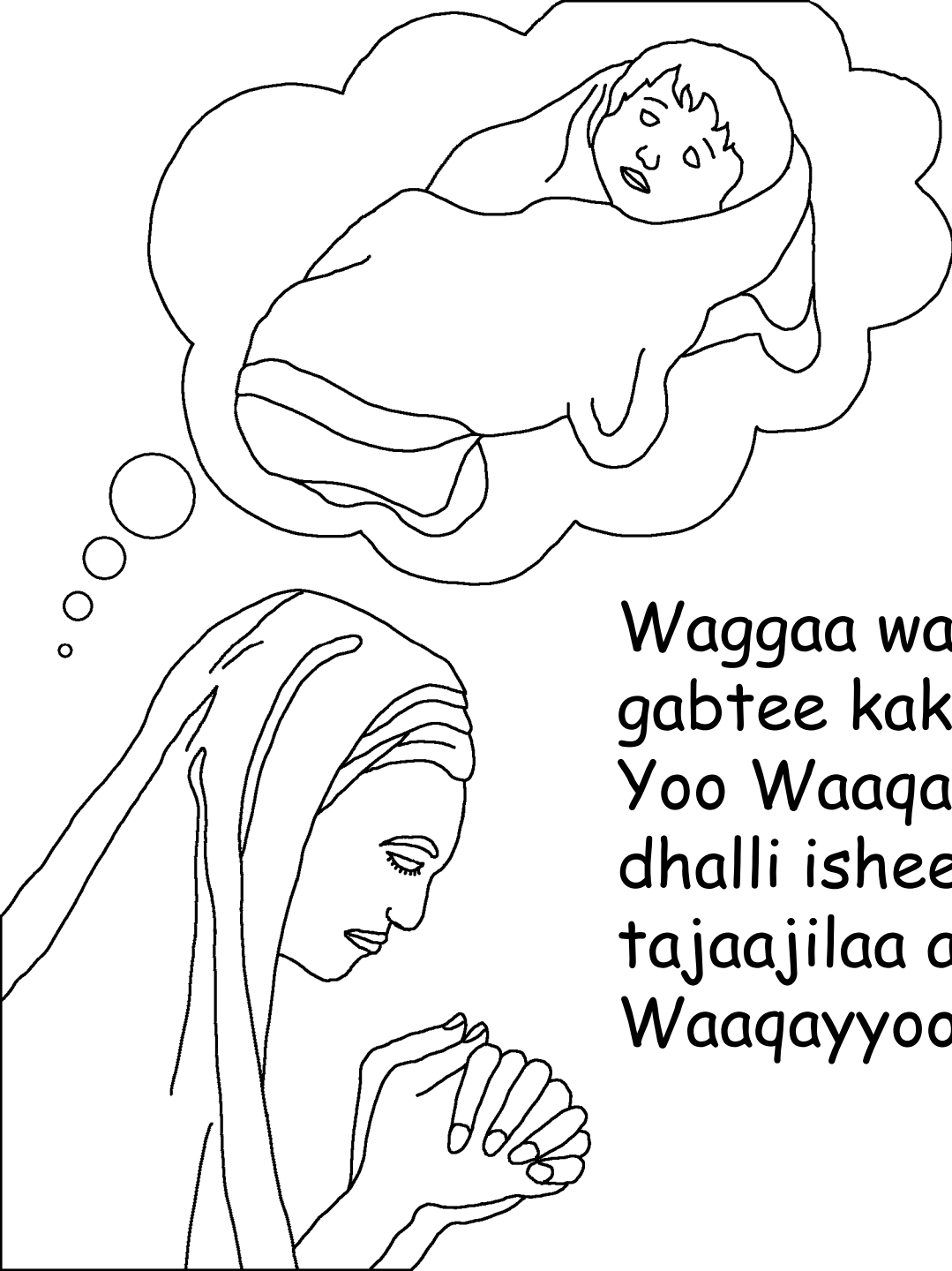

Waggaa waggaaan, Haannaan
gabtee kakuutti sagaduuf deemti.
Yoo Waaqayyo dhala isheef laate,
dhalli ishee bara isaa guutuu
tajaajilaa akka taasiftu
Waaqayyoof wadaa seente.



Lubi Eliin kadhannaa
Haannaa dhaga'e.
Yeroo kadhattu
hidhii Haannaa qofiti
waan socho'uuf waan
dhugaatii wayiniin
machoofta Eliitti
fakkaate.



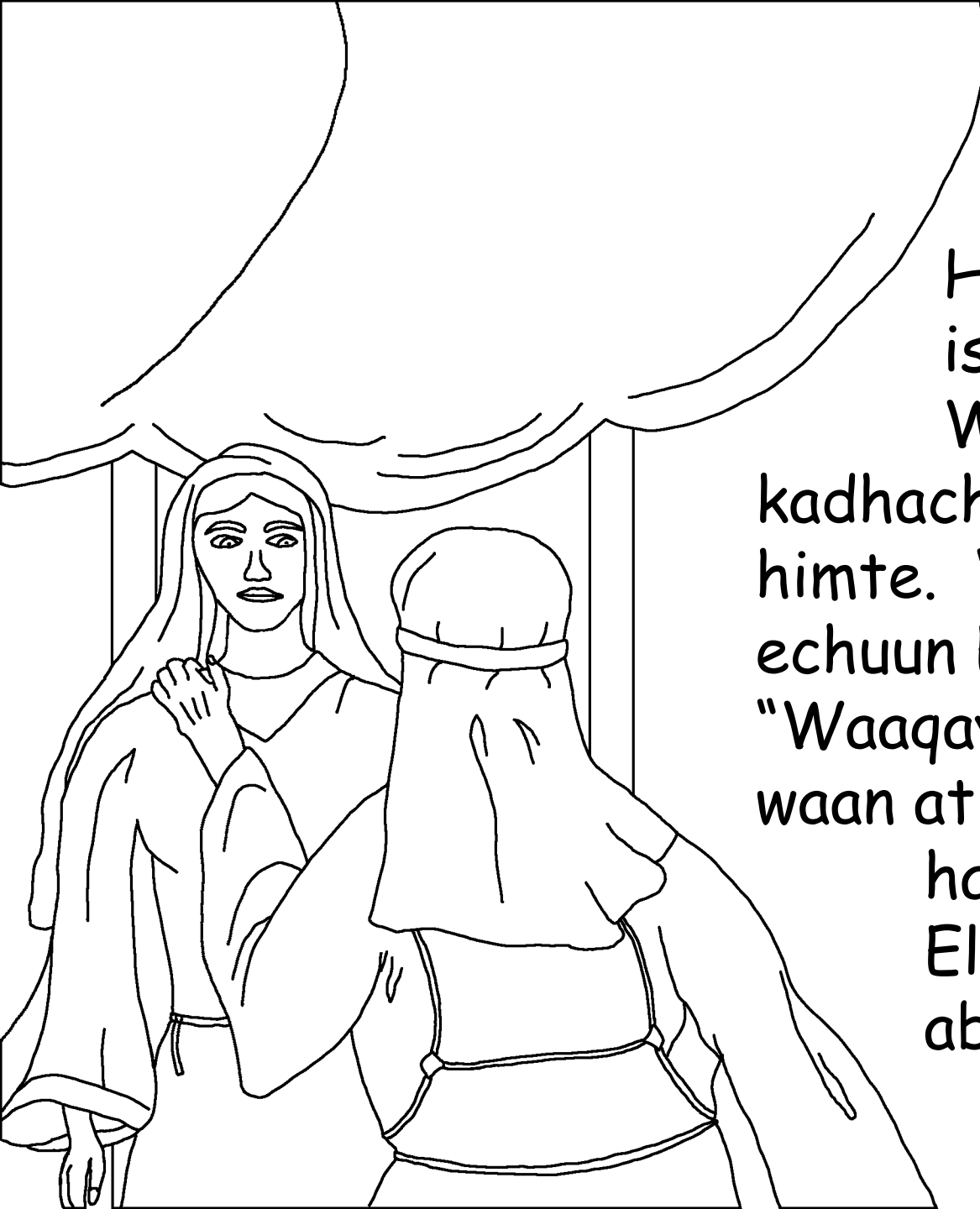

Haannaa mucaa dhaba
ishee fi waadaa
Waaqayyoof gaaluu
kadhachaa akka jirtu Eliitti
himte. "Nagaan dhaqi,"
echuun Eliin deebiseef.
"Waaqayyo inni kan Israa'el
waan ati isa kadhatte siif
haa kennu!" Jechooti
Elii Haannaatti
abdii hore.



Baattaluma sanaan gammachuu guddaan laphee
Haannaatti guutame. "Waaqayyo ishee yaadate"
kadhanna isheef deebii laate. Ishee fi Elqaanaan
mucaa maqaan isaa Saamu'eel jedhamu godhatan
(Hiikaan maqichaa "dhaga'uu Waaqayyoo") ti. Garuu
waadaa isheen galte waliin Waaqayyo yaadatee?

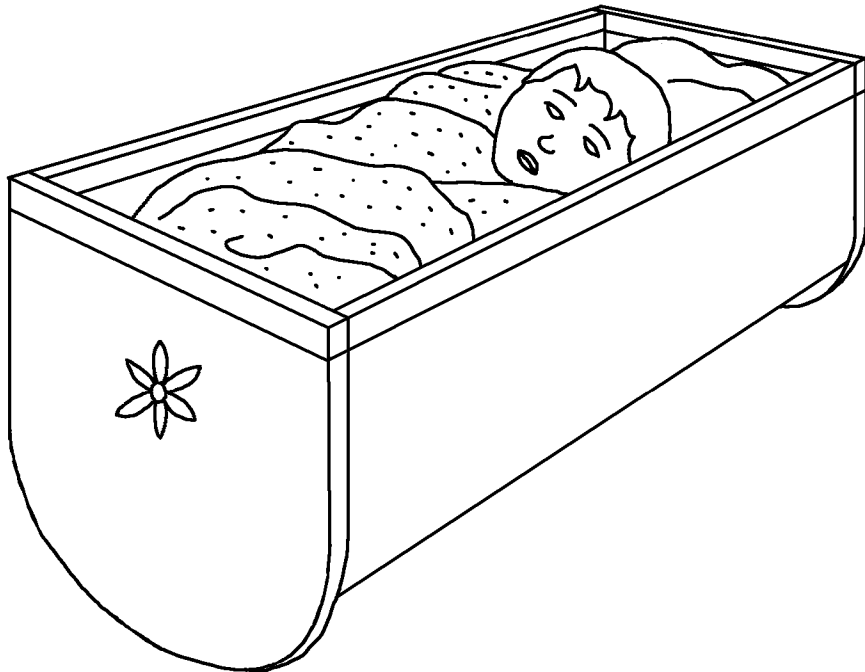



Waaqeffannaa waggaa
waggaan waaqessitu
Haannaan in dhaabde.
Oh waadaa Waaqayyof
galte in cabsitee?
Lakkii hin cabsine
hamma Saamu'eel
bara isaa guutuu Elii
gargaaruun Waaqayoon
tajaajiluu eegaa
turte. Achii booda,
gara gabatee kakuu
Israa'elootaa
jirutti fidde.



Amantii gutuu qabaachuu isheen Waaqayyo

Haannaa in
ulfeesse.

Saamu'eeliin

booda ilmaan dhiiraa
sadii fi dhalaa lama
deesse. Waggaa
waggaadahaan
waaqessuu yeroo
deemtu dirata fuula
isa quncee talbaa
irraa hojjetamee
diratee akka
tajaajiluuf haaraa
fidaafii turte.





Saamu'eel Eii gofaa utuu hin taane
ilamaan Eii Hophiin fi Phinehaas
bakka sanaa hojjechaa turan
gargaaraa ture. Garuu waan
Waaqa duratti hin tolle hojjechuun

Waaqayyoo ulfina
dhowwata hamma
abbaan isaanii
Eliin isaan
kadhatutti illee
gocha cubbu
hojjechuu irraa
hin deebine.



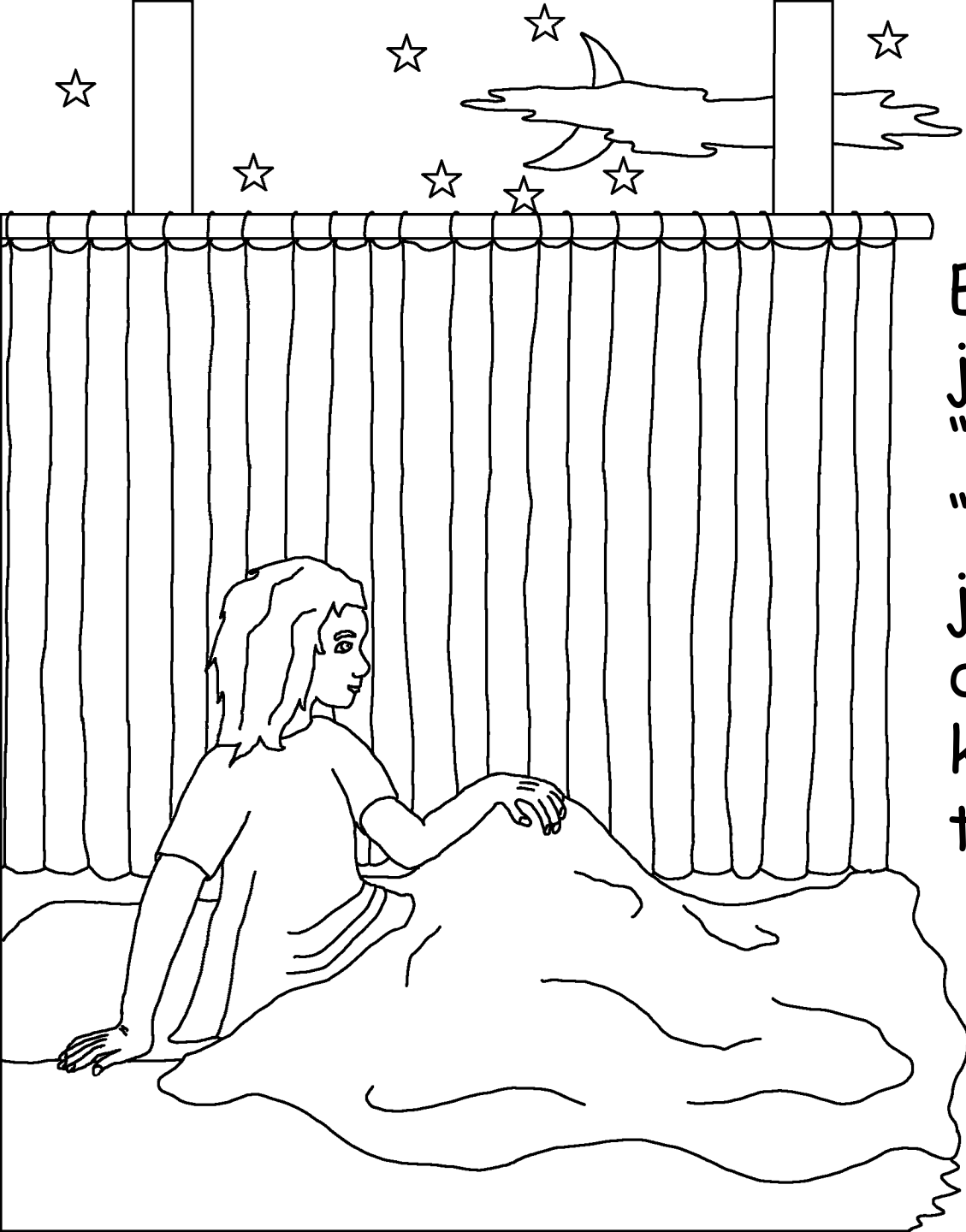

Halkan tokko,
Saamu'el sagalee
waamichaa dhaga'e.
Eliin akka isa waamaa
jiru ijoolleen itti hima.
"Ani asan jira," jedhe.
"Ani si hin waamne,"
jechuun Eliin
deebiseef. Taateen
kun yeroo sadaffaaf
ta'e. Waaqayyo akka
Saamu'eelitti
dubbachuu akka
barbaade Eliin bare.



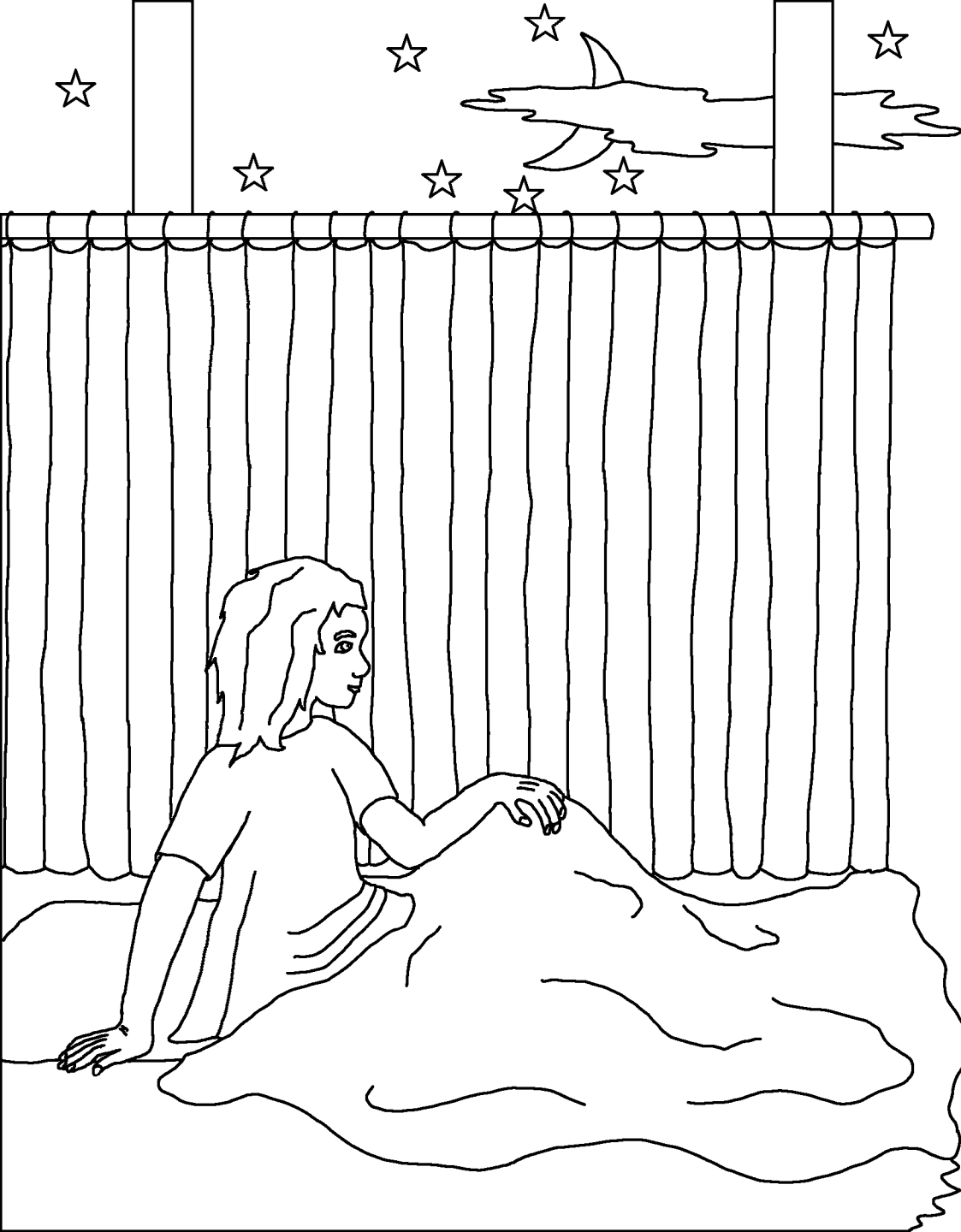

"Yeroo Waaqayyo
si waamu asan jira
garbicha keetti
dubbadhu gooftaa
jechuu qabda
jedhee Eliin
Saamu'eelitti
hime." Gooftaan
lammaffaa irra
deebi'ee hin
waamine ergaa
baayyee
barbaachisaa
ta'e itti laate.



Ganama Eliin Saamu'eeliin waame. "Waaqayyo maal sitti hime jedhee gaafate?" Qeerroon Saamu'ee waan hundumaa itti hime. Ergaan sun ergaa namatti hin tolle sababa gocha cubbuu Hofnii fi Fiinehaas irraa ka'een maatii Elii hundumaa akka balleessuf akka ta'e itti hime.



Akeekkachiis Waaqayyo dhugaa ta'e mul'ate.
Yeroo lola Filisxeemota waliinii cubbamooti
ijoollee Elii lameen gabatee kakuu baachuun
loltoota Israa'el dursaa turan.

Filisxeemonni Ilmaan Elii lameen
ajjeessuun gabatee kakuu fi
Israa'eloota danuu booji'an.

Eliin yeroo kana dhaga'e,
teessoo isaa irraa kufe,
boquunsaa isaa cabee,
achumaan du'e.



Gabateen kakuu Waaqayyoo haala gaddisiisaan harka warra Filisxeemotaa gale. Mana waaqeffannaa isaanii Daagon waaqas sobaa keessa kaa'an. Dagon isaanii gabtee kakuu duratti addaan gombifamee argan.

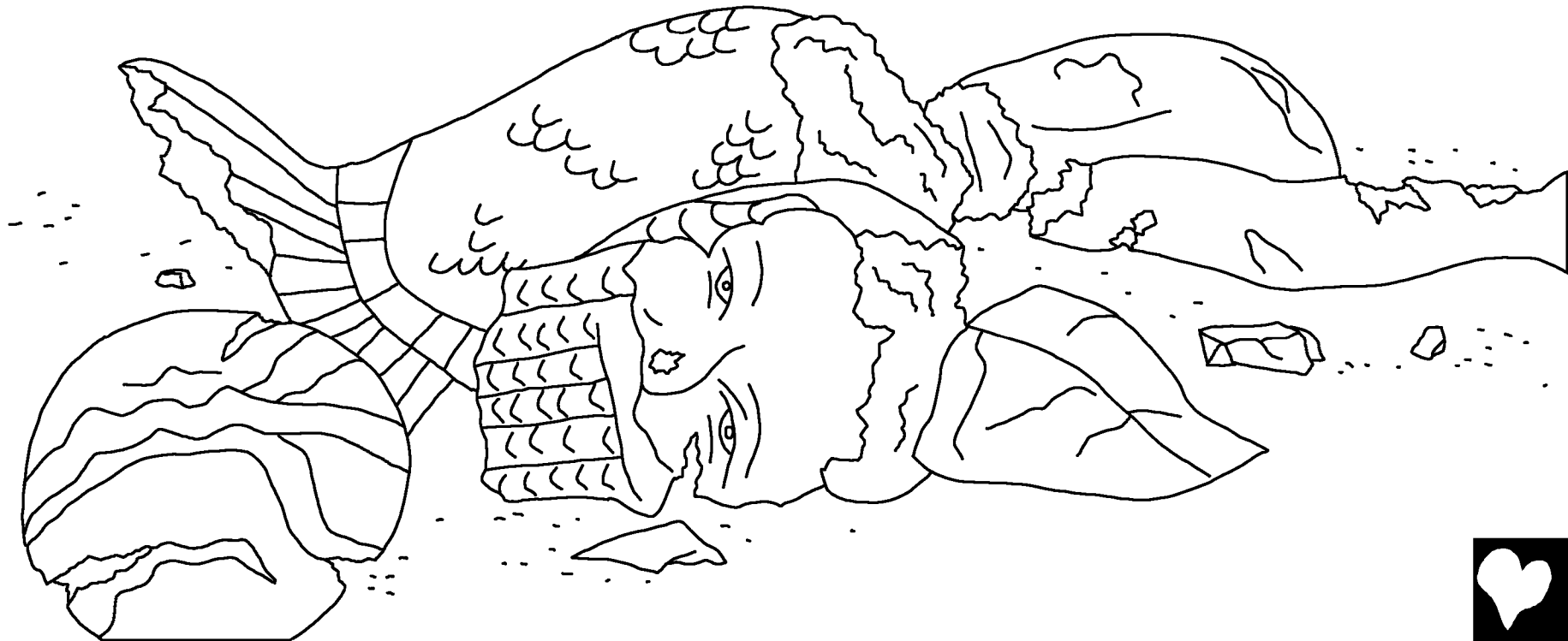

Daagon fuudhanii bakka isaatti deebisa. Guyyaa itti aanus yeroo dhaqan ammas saanduqa kakuu duraatti gombifamee argan. Alana garuu dhaqinasaa duwwaatu achi ture malee, mataan isaa fi harki isaa lamaan ciccitanii buusaa balbalaa galmichaa irra bubbu'anii turan.

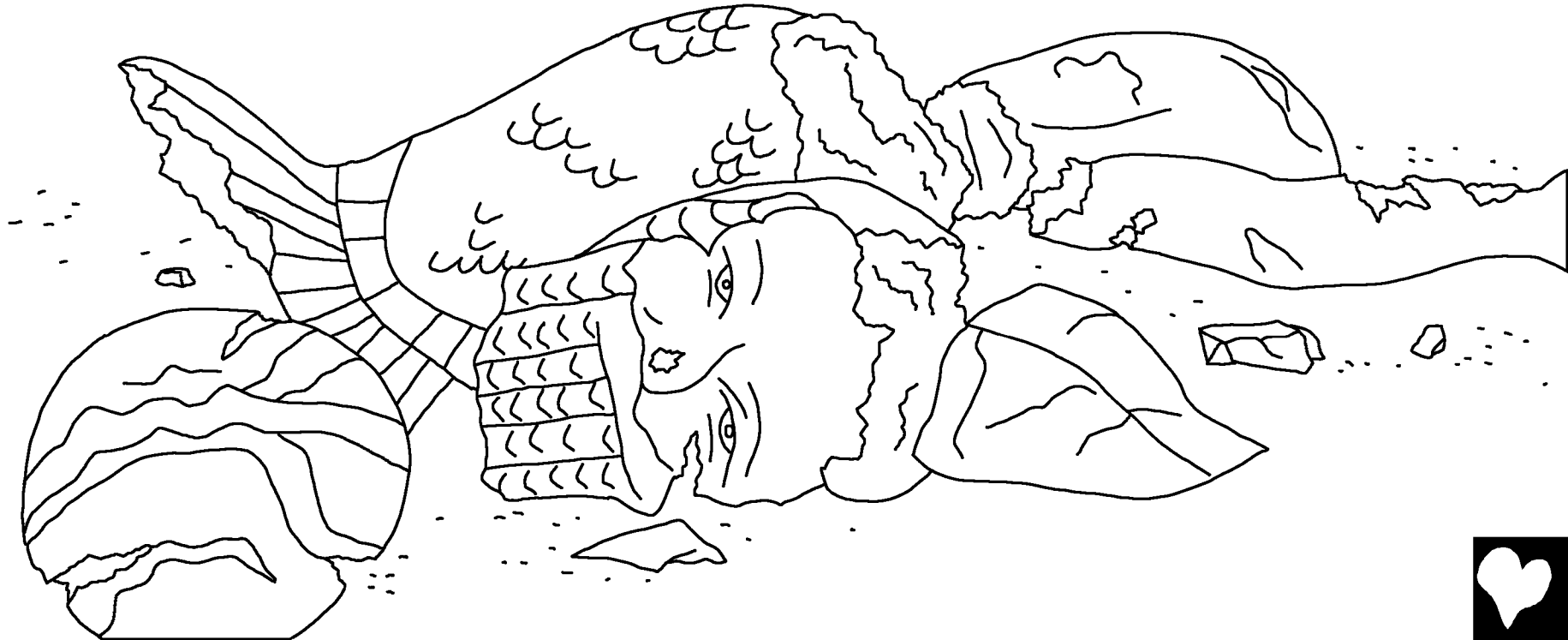

Dhibee fi du'i Filisxeemota
irratti ta'e. Akka dheekamsa
Waaqayyoo ta'e beekuuf
konkolaataa saawwaan
harkifamu fi gabatee
kakuu biyya isaanii alatti
ergan. Jabboota isanii
manatti hanbisan. "Yoo
saawwan sun jabbiilee
isaanii dhiisanni
Israa'eliin deeman, akka
dheekkamsa Waaqayyo
ta'e hubanna," jedhan.
Saawwan sun in sokkan!

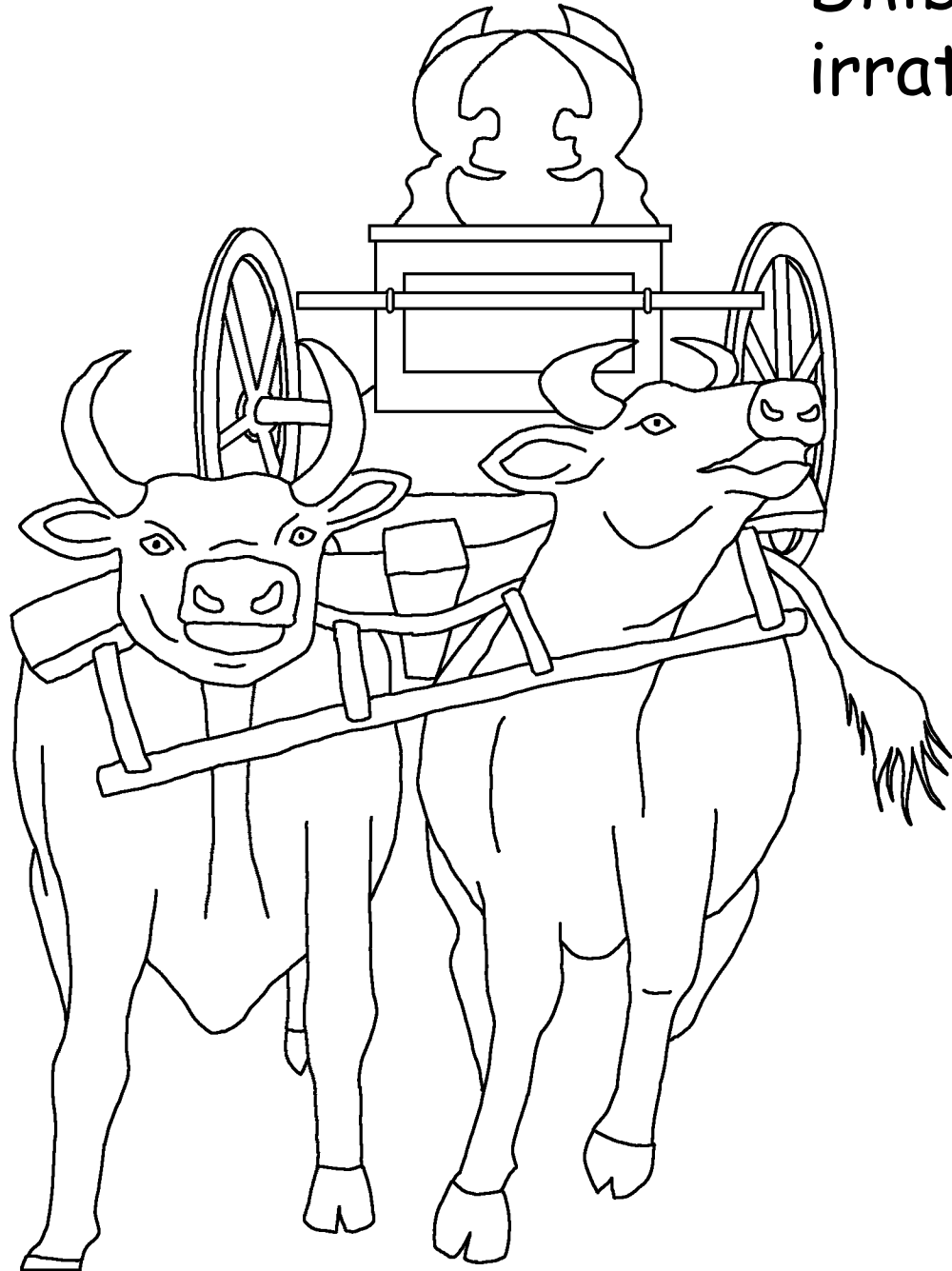

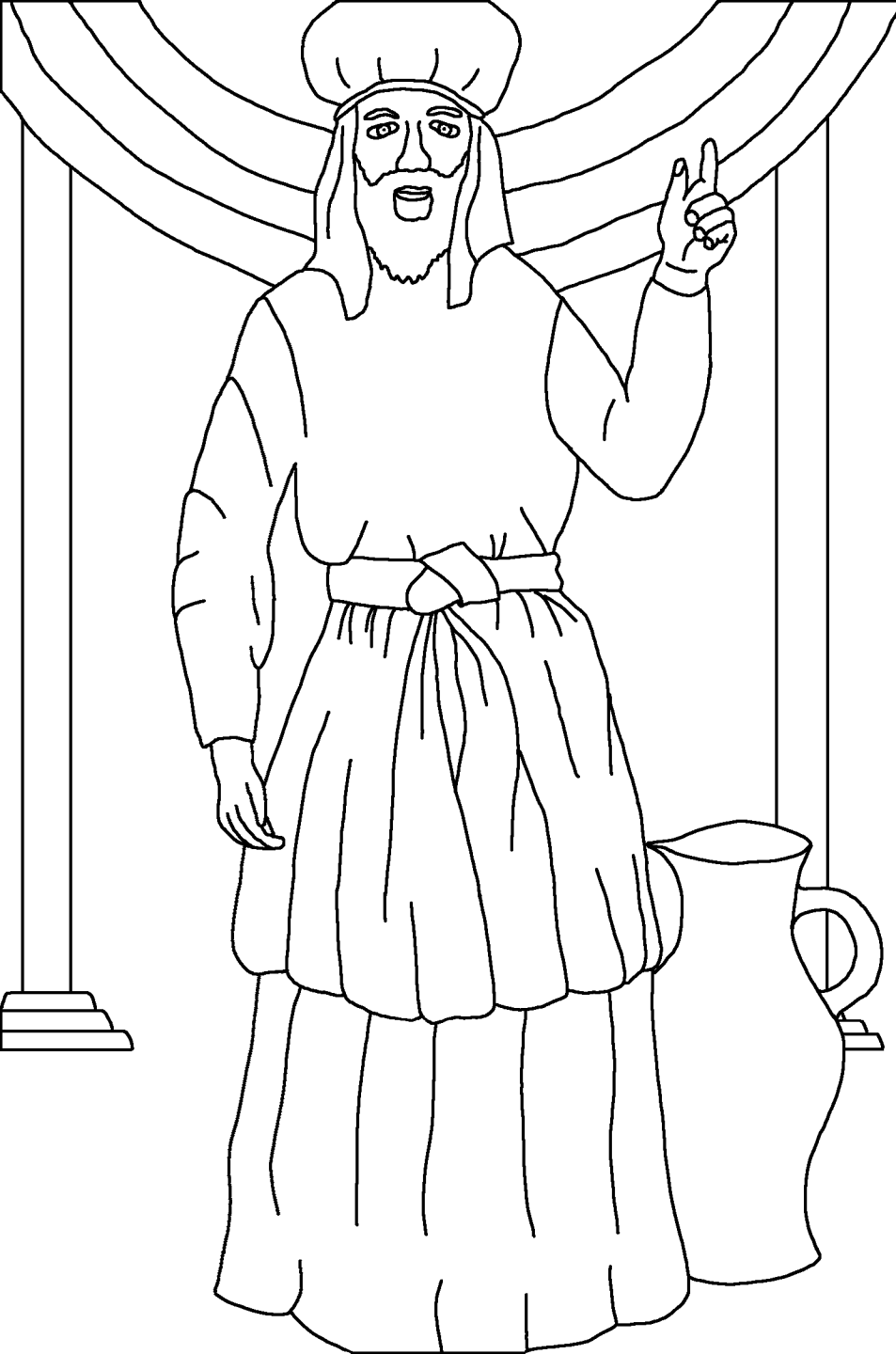

Isa booda namin
guddachaa jiru
Saamu'eel saba Israa'el
hundumaatti dubbate.
"Yoo isin laphee keessan
gutuudhaan gara
Waaqayyotti deebitan
..... haraka warra
Filisxeemotaa
keessaa isin baasa."



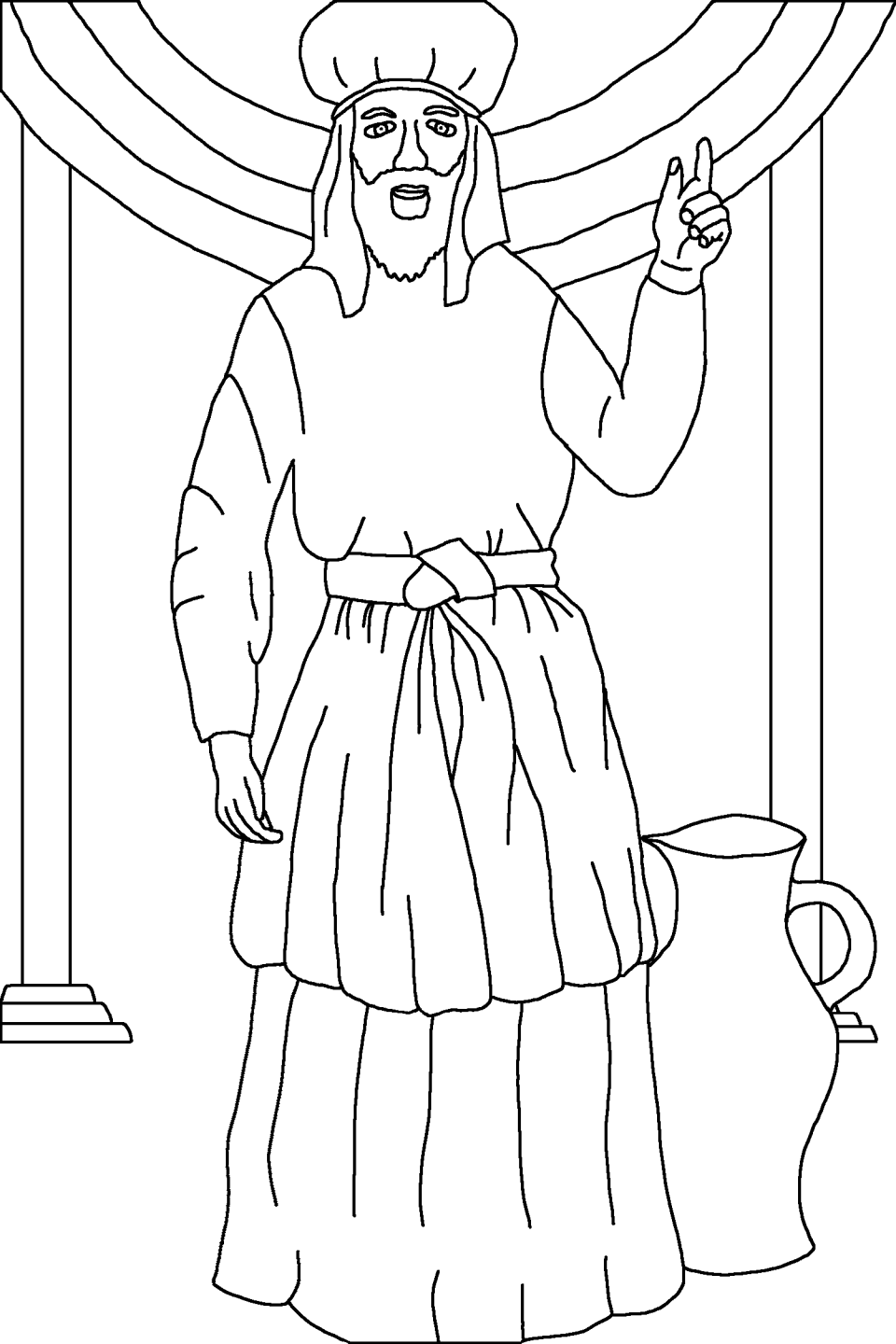

Raajii amantiin guutame
kanaaf sabin Israa'e
dhaga'uun Waaqayyoof
abboomame. Guyyaa
Saamu'el hundumaatti
harki Waaqayyoo
faallaa warra
Filisxeemotaa ta'e.



Ilma Waaqayyoo Tajaajilaa Saamu'eel
Seenaa Sagalee Waaqayyoo Macaafa Qulqulluu
kan keessatti argamu
Saamu'eel isa duraa 1-7

"Saaqamuun dubbii keetii ifa in kenna."
Faarsaa 119:130



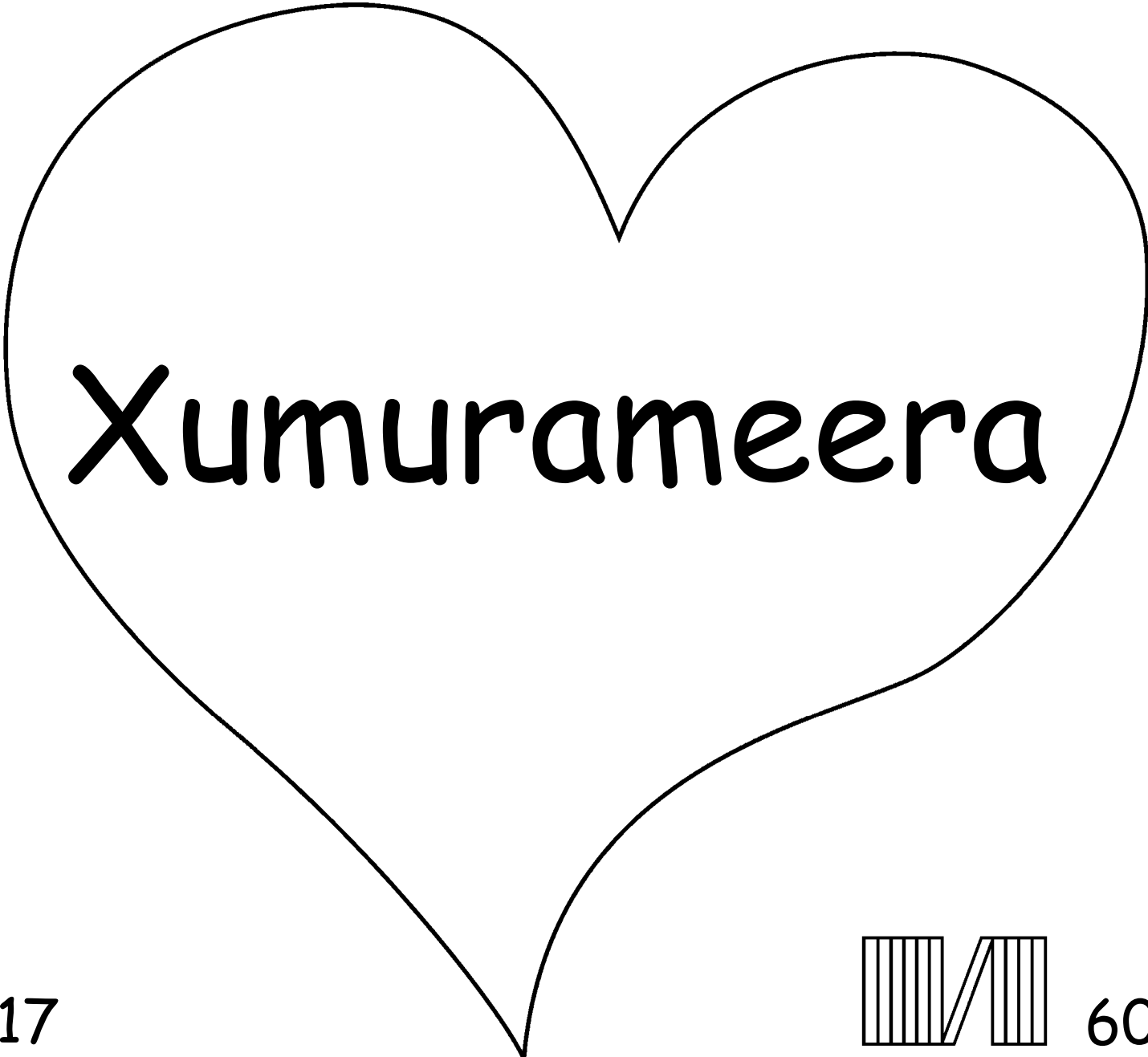

Xumurameera



17



60



Seenaan Macaafa Qulqulluu kun kan haasa'u waa'ee Waaqayyo keenya
Isa dinqii Isa nu uumeefi Isa akka Isa beeknu barbaaduuti.

Waaqayyo wanta hamaa isa Inni cubbuu jedhuun akka raaw'anne ni
beeka. Adabbiin cubbuu du'a. Waaqayyo garuu guddaa si jaallata,
kanaaf cubbuu keetiif akka fannoorratti du'uufi akka adabamuuf
Tokkicha Ilma Isaa Yesuus dabarsee siif ni kenne. Sana booda Yesuus
gara jireenyaatti deebi'ee gara iddoo jireenya Isaa gara Waaqaa ni
deeme! Yesuusitti amantee cubbuu keetiif akka siif dhiisuuf yoo Isa
gaafatte, Inni siif ni dhiisa! Yeroo kana dhufee si wajjin ni jiraata,
akkasumas immoo atis Isaa wajjin bara baraaf ni jiraatta.

Inni kun dhugaa ta'uu isaa yoo amante, Waaqayyoon akkas jedhiin:
Yaa Yesuus, Ati Waaqayyo ta'uu kee fi cubbuu kootiif du'uuf jettee
akka annaf dhufte nan amana, ammas kunoo deebitee ni jiraatta.
Maaloo gara jireenya kootti koottuutii amma jireenya haaraa akkan
jiraachuu akkan danda'uufi guyyaa tokko sin wajjin bara baraaf
jiraachuuf gara kee akkan dhaquuf cubbuu kootiif naaf dhiisi.
Abboommii kee akkan eeguufi akka mucaa keetti akkan jiraadhuuf
na gargaari. Ameen.

Macaafa Qulqulluu dubbisiitii guyyuma hundumaa Waaqayyoo
wajjin dubbadhu! Wangeela Yohaannis 3:16

