

Macaafa Qulqulluu Daa'immaniif Dhihaate

Ilma
Waaqayyoo
Tajaajilaa
Saamu'eel



Kan barreeffame: Edward Hughes

Kan ibsame: Janie Forest, Alastair Paterson

Kan dagaagsame: Lyn Doerksen

Kan hiikkame: Zemendale Translation Service
email: zemendale@gmail.com
Po Box 32155, Addis Ababa, Ethiopia

Kan qophaa'e: Bible for Children
www.M1914.org

©2024 Bible for Children, Inc.

Eeyyama: Seenaa kana hamma hin gugurreetti garagalfacuus
ta'ee Maxxansiifacuu ni dandeessu.

Haannaan dubartii gaariin nama gaarii Elqaanaanitti
heerumte. Lamaan isaanii Waaqayyoon waaqessuun
gaarummaa isaa namoota birootti agarsiisaa turan.
Garuu waanti tokko jireenya Haannaa keessaa hir'uu

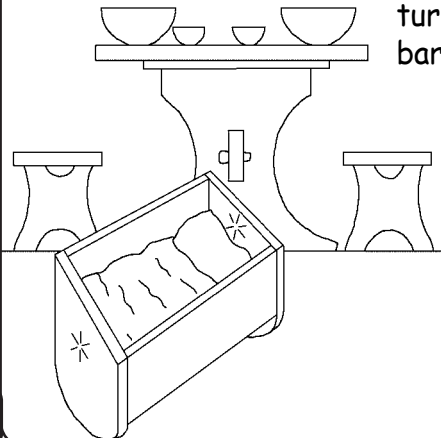

ture. Mucaa godhachuu
barbaaddi. Oh akkamitti
mucaa barbaadde!
Egeeun kadhatte
yeroo baayyee
eggatte. Mucaan
hin argamne!

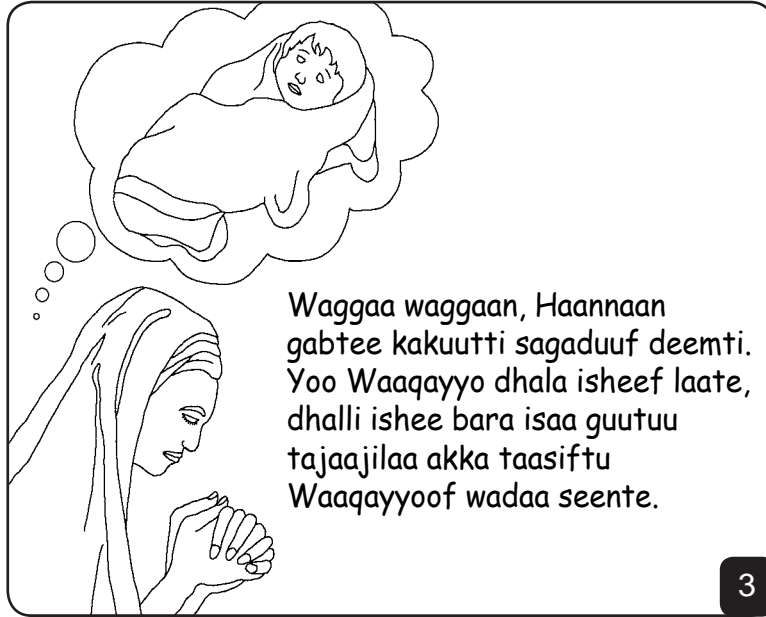

Waggaa waggaa, Haannaan gabtee kakuutti sagaduuf deemti. Yoo Waaqayyo dhala isheef laate, dhalli ishee bara isaa guutuu tajaajilaa akka taasiftu Waaqayyoof wadaa seente.

3



Lubi Eliin kadhannaa Haannaa dhaga'e. Yeroo kadhattu hidhii Haannaa qofiti waan socho'uuf waan dhugaatii wayiniin machoofte Eliitti fakkaate.

4



Haannaa mucaa dhaba ishee fi waadaa Waaqayyoof gaaluu kadhachaa akka jirtu Eliitti himte. "Nagaan dhaqi," echuun Eliin deebiseef. "Waaqayyo inni kan Israa'el waan ati isa kadhatte siif haa kennu!" Jechooti Elii Haannaatti abdi hore.

5

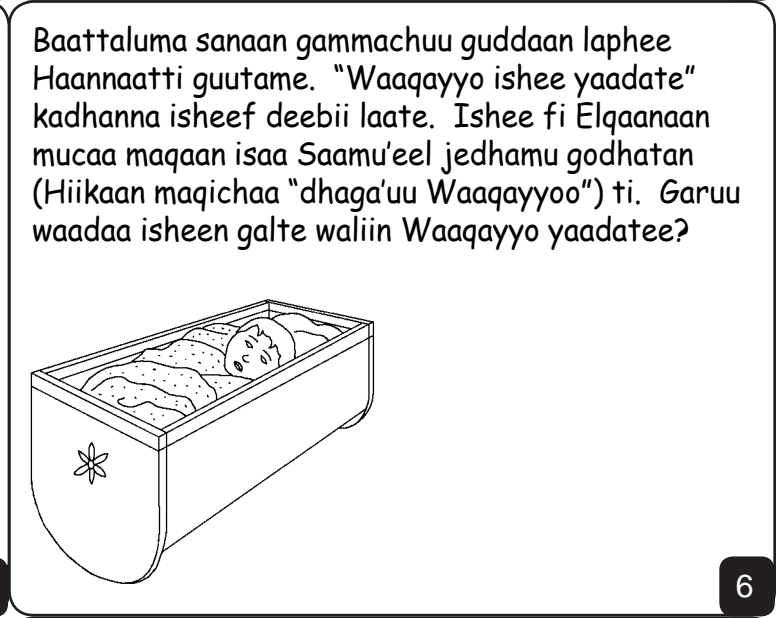

Baattaluma sanaan gammachuu guddaan laphee Haannaatti guutame. "Waaqayyo ishee yaadate" kadhanna isheef deebii laate. Ishee fi Elqaanaan mucaa magaan isaa Saamu'eel jedhamu godhatan (Hiikaan maqichaa "dhaga'uu Waaqayyoo") ti. Garuu waadaa isheen galte waliin Waaqayyo yaadatee?

6



Waaqeffannaa waggaa waggaa waaqessitu Haannaan in dhaabde. Oh waadaa Waaqayyof galte in cabsitee? Lakkii hin cabsine hamma Saamu'eel bara isaa guutuu Elii gargaaruun Waaqayyoon tajaajiluu eegaa turte. Achii booda, gara gabatee kakuu Israa'elootaa jirutti fidde.

7



Amantii gutuu qabaachuu isheen Waaqayyo Haannaa in ulfeesse.

Saamu'eeliin booda ilmaan dhiiraa sadii fi dhalaa lama deesse. Waggaa waggadaahan waaqessuu yeroo deemtu dirata fuula isa quncee talbaa irraa hojjetamee diratee akka tajaajiluuf haaraa fidaafii turte.

8

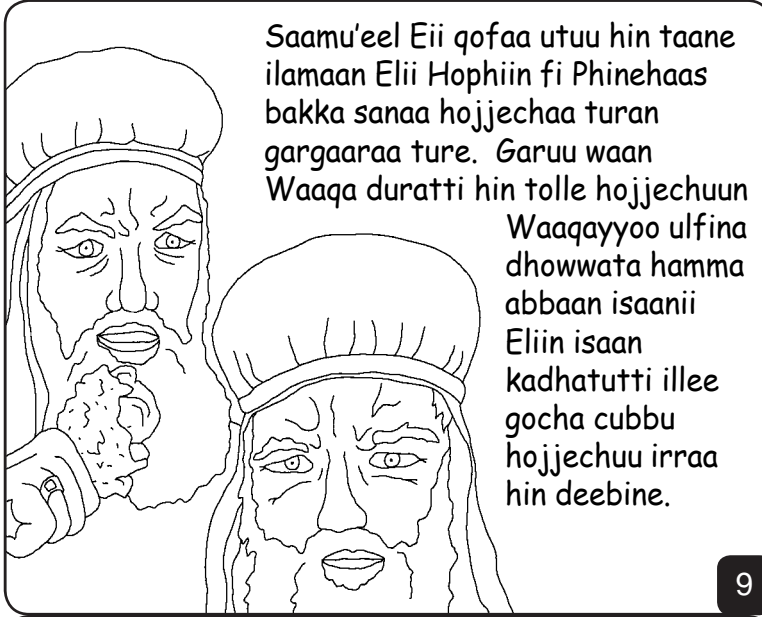

Saamu'eel Eii gofaa utuu hin taane ilamaan Elii Hophiin fi Phinehaas bakka sanaa hojjechaa turan gargaaraa ture. Garuu waan Waaqa duratti hin tolle hojjechuun Waaqayyoo ulfina dhowwata hamma abbaan isaanii Eliin isaan kadhatutti illee gocha cubbu hojjechuu irraa hin deebine.

9

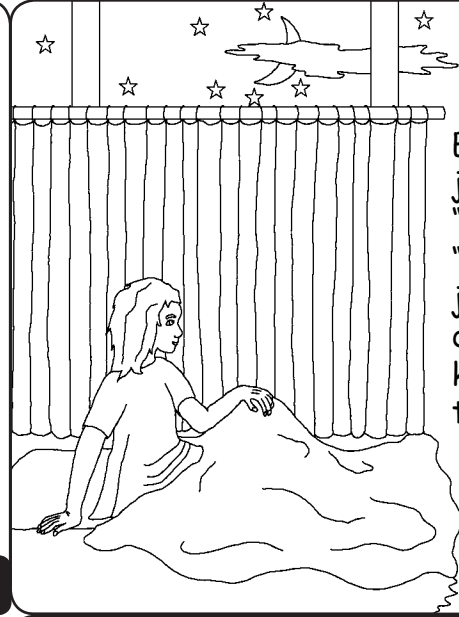

Halkan tokko, Saamu'el sagalee waamichaa dhaga'e. Eliin akka isa waamaa jiru ijoolleen itti hima. "Ani asan jira," jedhe. "Ani si hin waamne," jechuun Eliin deebiseef. Taateen kun yeroo sadaffaaf ta'e. Waaqayyoo akka Saamu'eelitti dubbachuu akka barbaade Eliin bare.

10

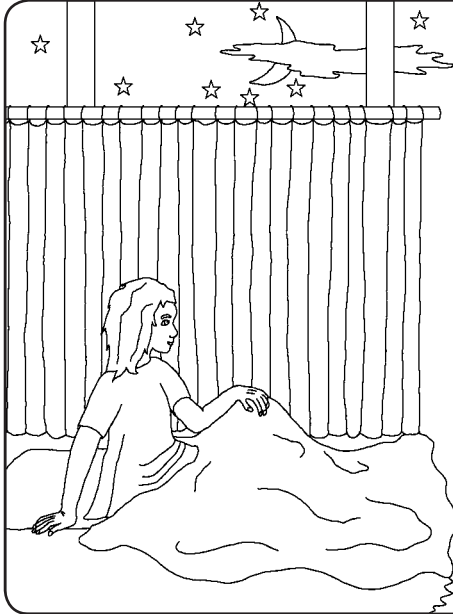

"Yeroo Waaqayyoo si waamu asan jira garbicha keetti dubbadhu gooftaa jechuu qabda jedhee Eliin Saamu'eelitti hime." Gooftaan lammaffaa irra deebi'ee hin waamine ergaa baayyee barbaachisaa ta'e itti laate.

11



Ganama Eliin Saamu'eeliin waame. "Waaqayyoo maal sitti hime jedhee gaafate?" Qeerroon Saamu'ee waan hundumaa itti hime. Ergaan sun ergaa namatti hin tolle sababa gocha cubbu Hofnii fi Fiinehaas irraa ka'een maatii Elii hundumaa akka balleessuf akka ta'e itti hime.

12

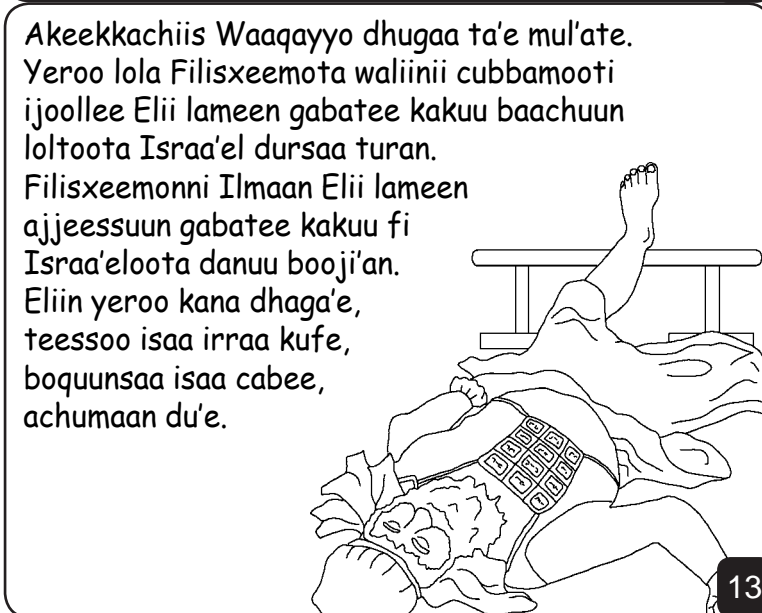

Akeekkachiis Waaqayyoo dhugaa ta'e mul'ate. Yeroo lola Filisxeemota waliinii cubbamooti ijoollee Elii lameen gabatee kakuu baachuun loltoota Israa'el dursaa turan. Filisxeemonni Ilmaan Elii lameen ajjeessuun gabatee kakuu fi Israa'eloota danuu booji'an. Eliin yeroo kana dhaga'e, teessoo isaa irraa kufe, boquunsaa isaa cabee, achumaan du'e.

13

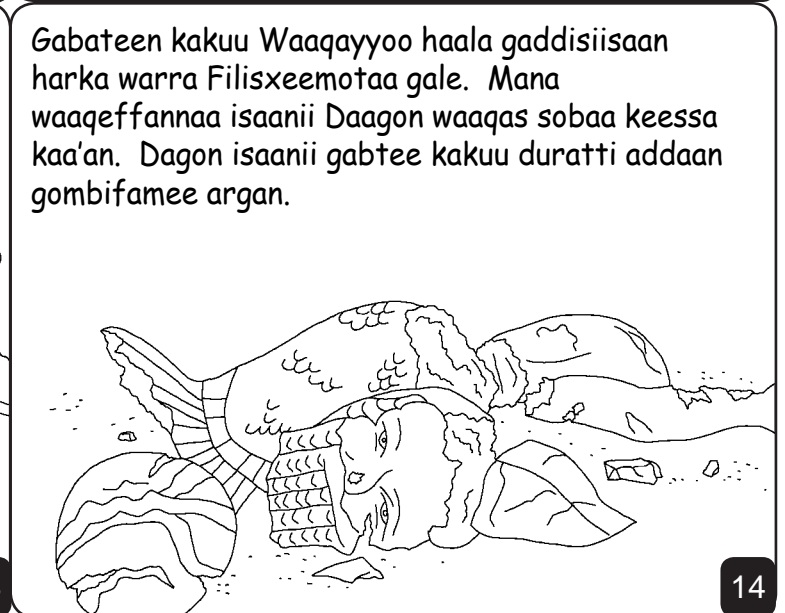

Gabateen kakuu Waaqayyoo haala gaddisiisaan harka warra Filisxeemotaa gale. Mana waaqeffannaa isaanii Daagon waaqas sobaa keessa kaa'an. Dagon isaanii gabtee kakuu duratti addaan gombifamee argan.

14

Daagon fuudhanii bakka isaatti deebisa. Guyyaa itti aanus yeroo dhaqan ammas saanduqa kakuu duraatti gombifamee argan. Alana garuu dhaqinasaa duwwaatu achi ture malee, mataan isaa fi harki isaa lamaan ciccitanii buusaa balbalaa galmichaa irra bubbu'anii turan.

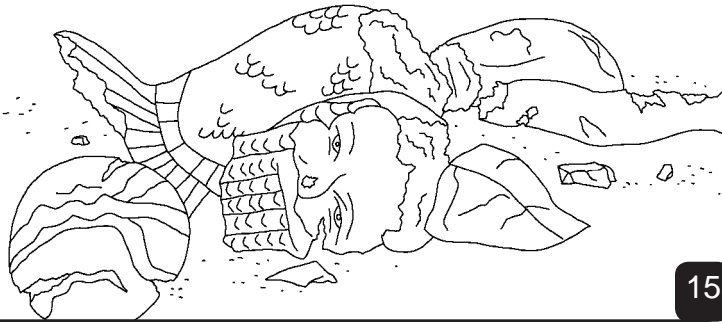

15

Dhibee fi du'i Filisxeemota irratti ta'e. Akka dheekamsa Waaqayyoo ta'e beekuuf konkolaataa saawwaan harkifamu fi gabatee kakuu biyya isaanii alatti ergan. Jabboota isanii manatti hanbisan. "Yoo saawwan sun jabbiilee isaanii dhiisanni Israa'eliin deeman, akka dheekamsa Waaqayyoo ta'e hubanna," jedhan. Saawwan sun in sokkan!

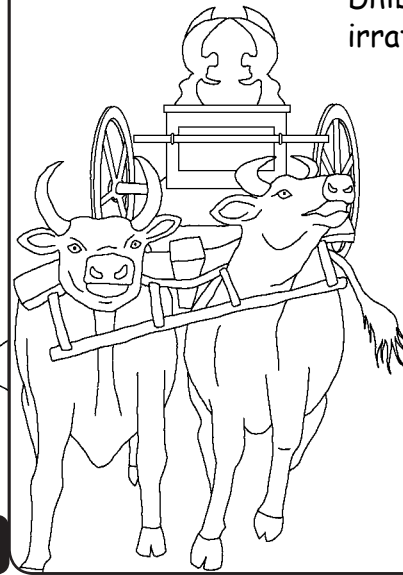

16

Isa booda namin guddachaa jiru Saamu'eel saba Israa'el hundumaatti dubbate. "Yoo isin laphee keessan gutuudhaan gara Waaqayyotti deebitan haraka warra Filisxeemotaa keessaa isin baasa."

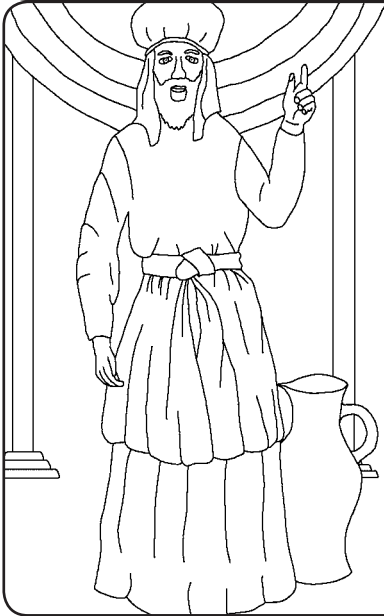

17

Raajii amantiin gutame kanaaf sabin Israa'e dhaga'uun Waaqayyooof abboomame. Guyyaa Saamu'el hundumaatti harki Waaqayyoo faallaa warra Filisxeemotaa ta'e.



18

Ilma Waaqayyoo Tajaajilaa Saamu'eel
Seenaa Sagalee Waaqayyoo Macaafa Qulqulluu
kan keessatti argamu
Saamu'eel isa duraa 1-7

"Saaqamuun dubbii keetii ifa in kenna."
Faarsaa 119:130

19

Xumurameera

17



60 20

Seenaan Macaafa Qulqulluu kun kan haasa'u waa'ee Waaqayyo keenya
Isa dinqii Isa nu uumeefi Isa akka Isa beeknu barbaaduuti.

Waaqayyo wanta hamaa isa Inni cubbuu jedhuun akka raaw'anne ni beeka. Adabbiin cubbuu du'a. Waaqayyo garuu guddaa si jaallata, kanaaf cubbuu keetiif akka fannoorratti du'uufi akka adabamuuf Tokkicha Ilma Isaa Yesuus dabarsee siif ni kenne. Sana booda Yesuus gara jireenyaatti deebi'ee gara iddoo jireenya Isaa gara Waaqaa ni deeme! Yesuusitti amantee cubbuu keetiif akka siif dhiisuuf yoo Isa gaafatte, Inni siif ni dhiisa! Yeroo kana dhufee si wajjin ni jiraata, akkasumas immoo atis Isaa wajjin bara baraaf ni jiraatta.

Inni kun dhugaa ta'uu isaa yoo amante, Waaqayyoon akkas jedhiin: Yaa Yesuus, Ati Waaqayyo ta'uu kee fi cubbuu kootiif du'uuf jettee akka annaf dhufte nan amana, ammas kunoo deebitee ni jiraatta. Maaloo gara jireenya kootti koottuutii amma jireenya haaraa akkan jiraachuu akkan danda'uufi guyyaa tokko sin wajjin bara baraaf jiraachuuf gara kee akkan dhaquuf cubbuu kootiif naaf dhiisi. Abboommii kee akkan eeguufi akka mucaa keetti akkan jiraadhuuf na gargaari. Ameen.

Macaafa Qulqulluu dubbisiitii guyyuma hundumaa Waaqayyoo
wajjin dubbadhu! Wangeela Yohaannis 3:16