

# Macaafa Qulqulluu Daa'immaniif Dhihaate



## Mootii Daawwiti (Kutaa 2)



Kan barreeffame: Edward Hughes

Kan ibsame: Lazarus, Alastair Paterson

Kan dagaagsame: Ruth Klassen

Kan hiikkame: Zemendale Translation Service  
email: zemendale@gmail.com  
Po Box 32155, Addis Ababa, Ethiopia

Kan qophaa'e: Bible for Children  
[www.M1914.org](http://www.M1914.org)

©2024 Bible for Children, Inc.

Eeyyama: Seenaa kana hamma hin gugurreetti garagalfacuus  
ta'ee Maxxansiifacuu ni dandeessu.

1

Kibba Israa'elitti Daawwiti  
mootii Yuudaa ture.

Garuu guutummaan  
Israa'el Ish-Bosheetiin  
dhhunfatamee jira,  
ilma mootii Saa'ol,  
Lolli waliin  
waliin waggaa  
torbaaf isaan  
gidduutti ta'e.  
Yeroo kanatti  
Daawwiti daran  
jabaachuun  
guddachaa dhufe.

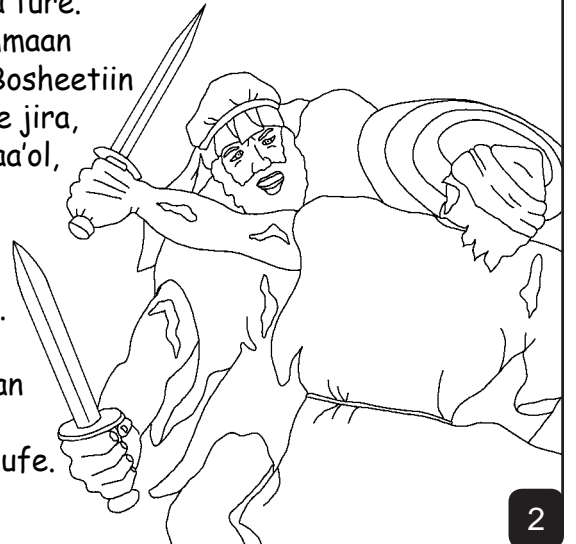

2

Xumura iratti mootiin Ishi-Bosheeti ilmaan isaa loltuu lamaan ajjeefame.

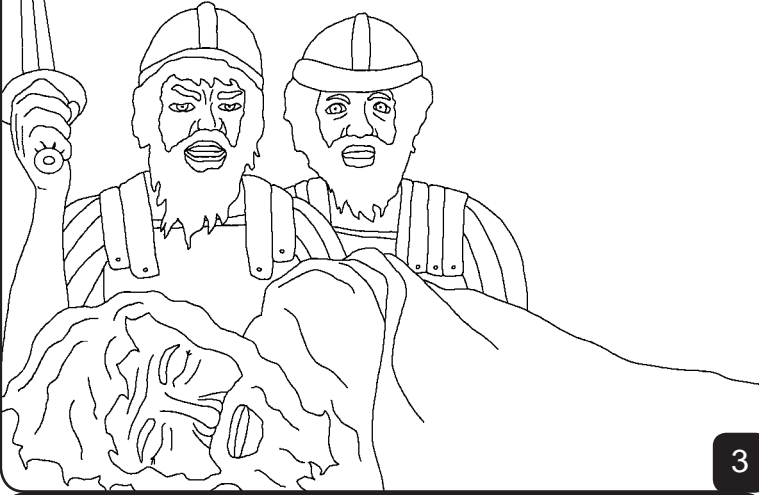

3

Isa booda Sabin Israa'el hundi gara Daawwiti isa dibamee ta'uun mootii ta'eef. Saba Israa'el hundumaa irratti yeroo dhumaaf Daawwiti mootii ta'e.

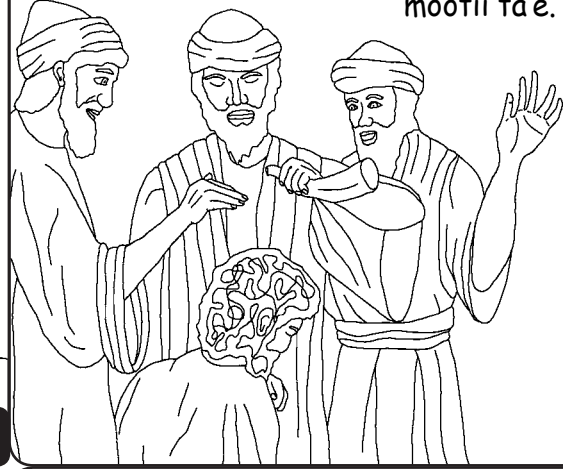

4

Daawwiti gochaa isaa isa jalqabaatiin Yarusaleemiin to'ate. Magaalaa Daawwiti jechuun beekamte. Akka isheen lammaffaa diinaan hin weeraramnetti irra deebi'ee magaalaa Yarusaleemiin ijaare.

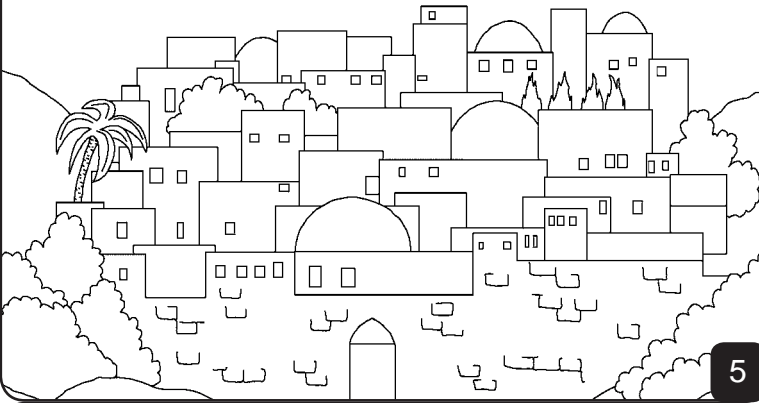

5

Daawwiti itti aansuudhaan, gabatee kakuu Waaqayyoo gara Yarusaleemitti fide. Gabateen kakuu sun abboommii Waaqayyoo kurnanii fi koppii seerora biroo Waaqayyoon Museetti laataman ofi iirraa qaba. Gabateen kakuu Waaqayyoo guddummaa Waaqayyoo fi barbaachisummaa isaaf abboomamuu saba Israa'eliin yaadachiise.

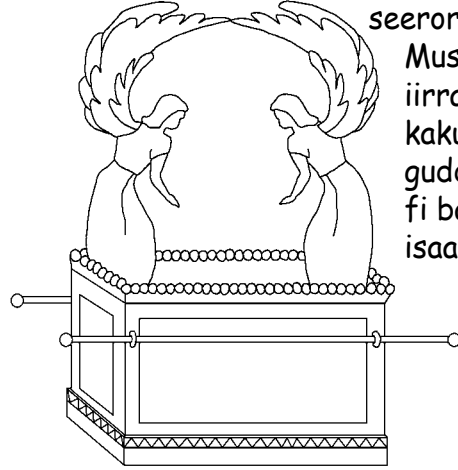

6

Utuu gara mootii ta'utti hin dhufin dura Daawwiti dirree lolaa danuu irratti hirmaate ture. Yeroo kanatti Daawwiti loltuu abshaala, qajeelfamoota Waaqayyoo eeguuf kadhatu fi nama fuula Waaqayyoo duratti gad of qabu ture.

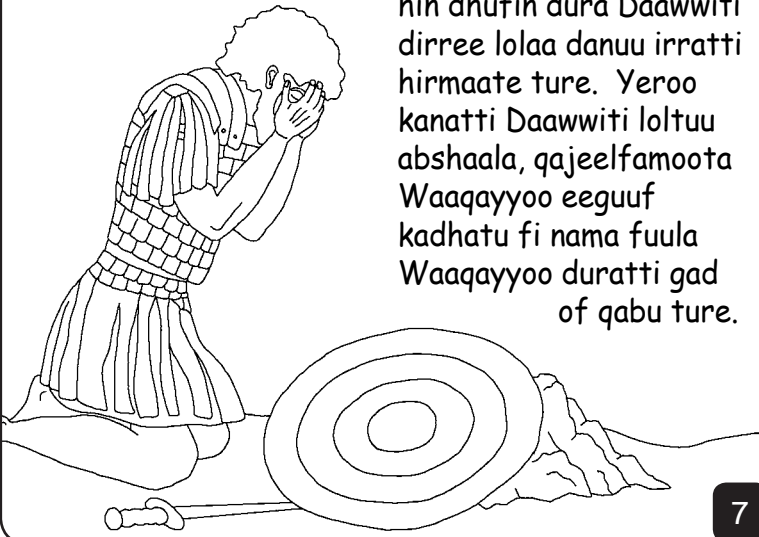

7

Daawwiti gabateen kakuu Waaqayyoo godoo keessa taa'ee inni mana gaarii keessa jiraachuu isaatti waan dhiphateef Mana qulqullummaa ijaaruu murteesse. Raajiin Waaqayyoo Daawwiti yaada isaa kana akka raawwatuu itti hime.

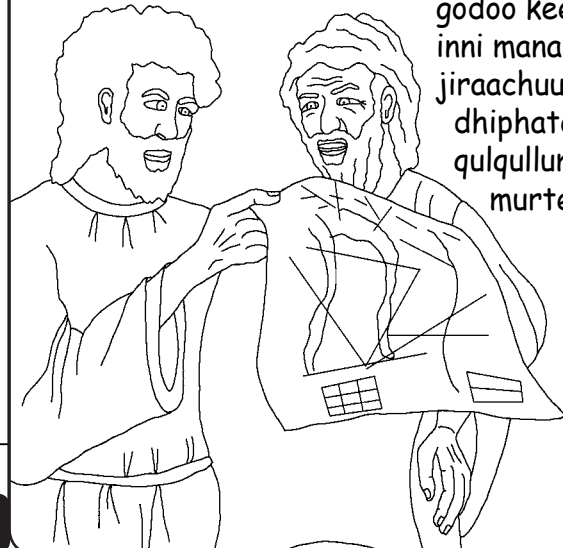

8

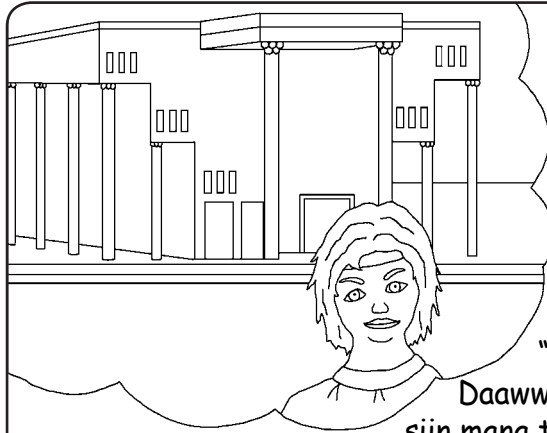

Halkan sana,  
Waaqyyo  
ergaa  
Daawwititti  
erge.

"Garbicha koo  
Daawwiti, Waaqayyo  
siin mana taasisa. Yeroo

guyyichi ga'u abbootii keetii waliin itti in boqotta,  
ilmaan kee si boodaan dhufan mootii taasisa. Maqaa  
koof jecha manaicha in ijaaru masaraa isaan  
dhaaban immoo hamma barabaraatti in ta'a."

9

Daawwiti maatii Saa'ol gargaaruu barbaade.  
Sababa madaa'utiin kan deemuu hin dandeenya  
Ilma Yoonataan Mephibosheetii arge.  
"Akka ilamaan mootiitti maaddii  
hanyaatu," jedhe Daawwiti.  
Sababa abbaan isaa  
Yoonataa michuu gaarii  
Daawwiti tureef  
Mephibosheetiif  
gaarummaa qaba.

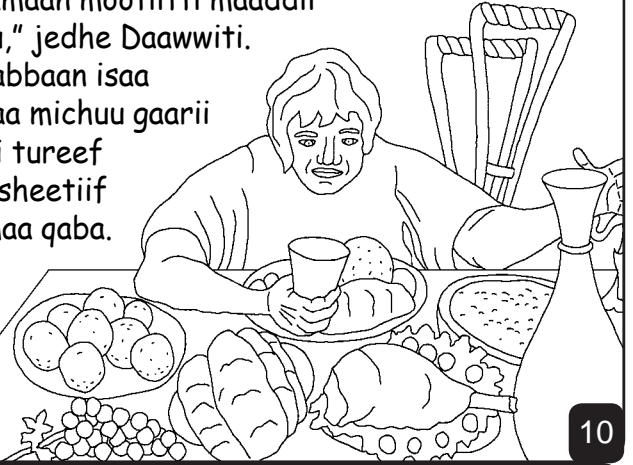

10

Akkuma Daawwiti  
Waaqayyoon amanateen  
dubbii sagalee Waaqaa  
abboomameen, Daawwiti  
badhaadhummaatti akka  
ce'uuf Waaqayyo isa  
gargaare. Garuu guyyaa  
tokko gaaddidduun cubbuu  
tokko jireenya Daawwiti  
irratti kufe.

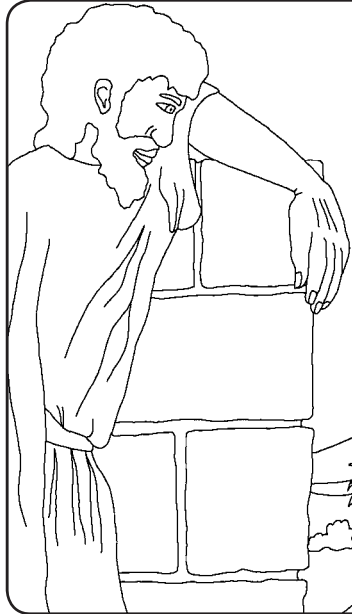

11

Halkan guyyaa tokkoo,  
rafuu dadhabe. Guutuu  
mmanaa irra ba'ee asiif achi  
deemee magaalaa ilaale.



12

Yeroo kanatti dubartii bareedduu  
dhagina dhiqattu arge. Maqaan  
ishee Baat-Sheebaa jedhama.  
Abbaan manaa Baati-Sheebaa  
Uriyaan loltuu Daawwiti  
isa goota ta'us Daawwiti  
Baat-Sheebaa waliin cubbuu  
hojjete. Isa booda ulfa ta'u  
ishee yeroo Daawititti himtu  
cubbuunsaa rakkoo dabalee  
uumaa akka jiru bare.



13

Bakka Waaqayyoon  
dhugaa ba'u Daawwiti  
rakkoo isaa dhokisuuf  
dadhabe. Innis isa oolchuu hin dandeenye!  
Dirree waraanaa irraa Uriyaa gara manaatti waame,  
mucaan dhalachuuf jedhu akka kansaa isaa ta'uu isa  
abdachiise. Uriyaan garuu utuu hiriyootti isaa dirree  
lola irra jiranii mana ta'uu fedha isaa hin turre.  
Uriyaan balbala dura mootiitti rafe.

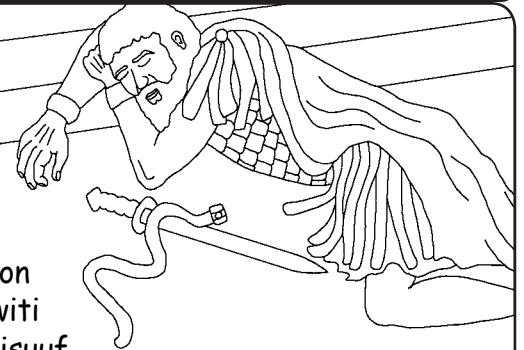

14

Daawiti cubbuu badaa dabalee hojjete. Xalayaa waliin Uriyaa gara dirree lolaatti deebisee erge. Xalayichi ajajaan waraanaa dirree lolaa irratti Uriyaan akka du'u egaa jedhu qabatee jira. Yeroo Uriyaan du'u Daawit Baati-Sheebaa haadha manaa godhatee.



15

Cubbuu Daawiti hojjete itti agarsiisuuf Waaqayyo garbicha isaa Naataaniin itti erge. Naataan oduu waa'ee nama sooressaa fi hiyyeessaa itti hime. Namichi sooressa hoolota dhibba tokko qaba. Namichi hiyyeessi garuu hoolaa tokkittii akka intala durbaa isaatti kan ilaalu qaba.



16

Yeroo imaltooti gara namicha isa sooressaa dhufan, isaan nyaachisuuf hoolota isaa keessa tokko hin qalleef, bakka isaa hoolaa isa hiyyeessaa fuudhee qaleef.

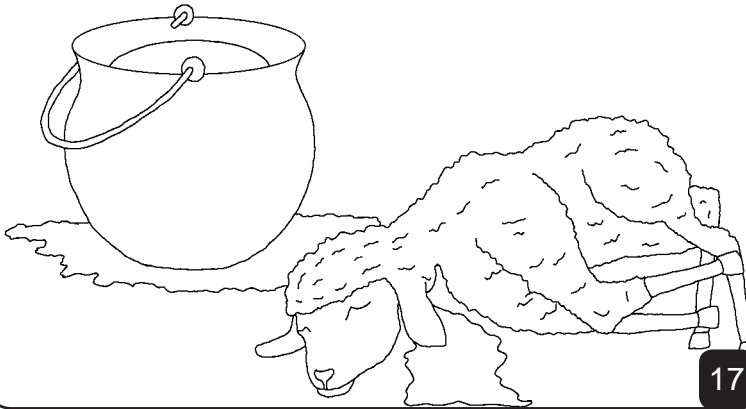

17

Ofjaalchuu namicha sooressaatti Daawit aare. Hin iyye, "Namichu akkas godhe du'uu qaba jedhe."



18

Yoonaaanis, "Ati namicha sana!" jedhee Daawititti hime. Waanti Daawit hojjete waan namichi sooressi oduu sana keessatti raawwateen oli.

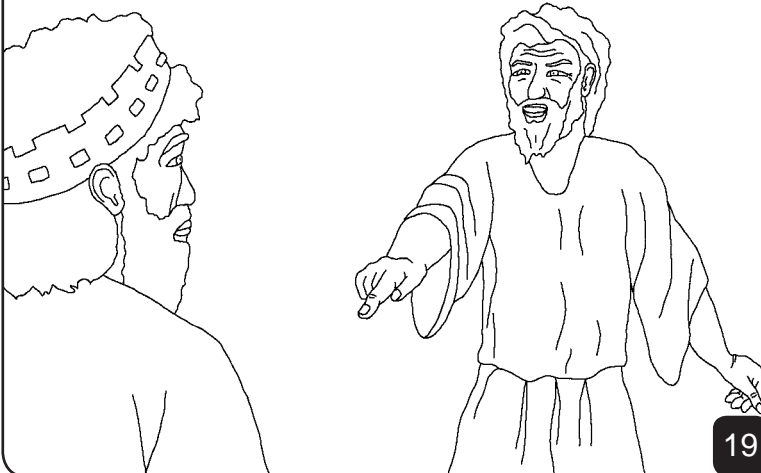

19

Waaqayyo Daawiti cubbamaa akkamii akka ta'e itti agarsiise. Daawiti cubbuu hojjetetti in gaabbe. "Siyaakeera jedhee Daawit Waaqayyotti dubbate." Waaqayyos Daawiti dhiifama taasise. Garuu mucaan Baati-Sheebaa baayyee dhukkubsate, battaluma dhalatteen duute.



20

Waaqayyo cubbuu Daawitiif  
dhiifama taasise. Baati  
Sheebaan mucaa biraa  
Solomoon Daawititti aanee  
kan mootii ta'u qabdi ture.  
Garuu mootii Daawiti ijoollee  
biraa baayyee qaba ture,  
baayeen isaanii  
gadda taa'aniiru.



21

Mootii Daawwiti (Kutaa 2)

Seenaa Sagalee Waaqayoo Macaafa Qulqulluu

kan keessatti argamu

Saamu'eela isa lammaffaa 1-12

"Saaqamuun dubbii keetii ifa in kenna."  
Faarsaa 119:130

22

Xumurameera

21



60

23

Seenaa Macaafa Qulqulluu kun kan haasa'u waa'ee Waaqayyo keenya  
Isa dinqii Isa nu uumeefi Isa akka Isa beeknu barbaaduuti.

Waaqayyo wanta hamaa isa Inni cubbuu jedhuun akka raaw'anne ni  
beeka. Adabbiin cubbuu du'a. Waaqayyo garuu guddaa si jaallata,  
kanaaf cubbuu keetiif akka fannooratti du'uufi akka adabamuuf  
Tokkicha ilma Isaa Yesuus dabarsee siif ni kenne. Sana booda Yesuus  
gara jireenyaatti deebi'ee gara iddoo jireenya Isaa gara Waaqaa ni  
deeme! Yesuusitti amantee cubbuu keetiif akka siif dhiisuuf yoo Isa  
gaafatte, Inni siif ni dhiisa! Yeroo kana dhufee si wajjin ni jiraata,  
akkasumas immoo atis Isaa wajjin bara baraaf ni jiraatta.

Inni kun dhugaa ta'uu isaa yoo amante, Waaqayyoon akkas jedhiin:  
Yaa Yesuus, Ati Waaqayyo ta'uu kee fi cubbuu kootiif du'uuf jettee  
akka annaf dhufte nan amana, ammas kunoo deebitee ni jiraatta.  
Maaloo gara jireenya kooti koottuutii amma jireenya haaraa akkan  
jiraachuu akkan danda'uufi guyyaa tokko sin wajjin bara baraaf  
jiraachuuf gara kee akkan dhaquuf cubbuu kootiif naaf dhiisi.  
Abboomii kee akkan eeguufi akka mucaa keetti akkan jiraadhuuf  
na gargaari. Ameen.

Macaafa Qulqulluu dubbisiitii guyyuma hundumaa Waaqayyoo  
wajjin dubbadhu! Wangeela Yohaannis 3:16

24