

Macaafa Qulqulluu Daa'immaniif Dhihaate

Yonaas fi
Qurxummii
Guddicha



Kan barreeffame: Edward Hughes

Kan ibsame: Jonathan Hay

Kan dagaagsame: Mary-Anne S.

Kan hiikkame: Zemendale Translation Service
email: zemendale@gmail.com
Po Box 32155, Addis Ababa, Ethiopia

Kan qophaa'e: Bible for Children
www.M1914.org

©2024 Bible for Children, Inc.

Eeyyama: Seenaa kana hamma hin gugurreetti garagalfacuu
ta'ee Maxxansiifacuu ni dandeessu.



Waggaa dheeraa dura, naming maqaan
isaa Yoonaas jedhamu Irsaa'el keessa
in jiraata ture. Guyyaa tokko

magaalaa baayee guddittii
cintuu addunyaa
Nanawee

dhaqi
jechuun
Waaqayyo
itti dubbate.

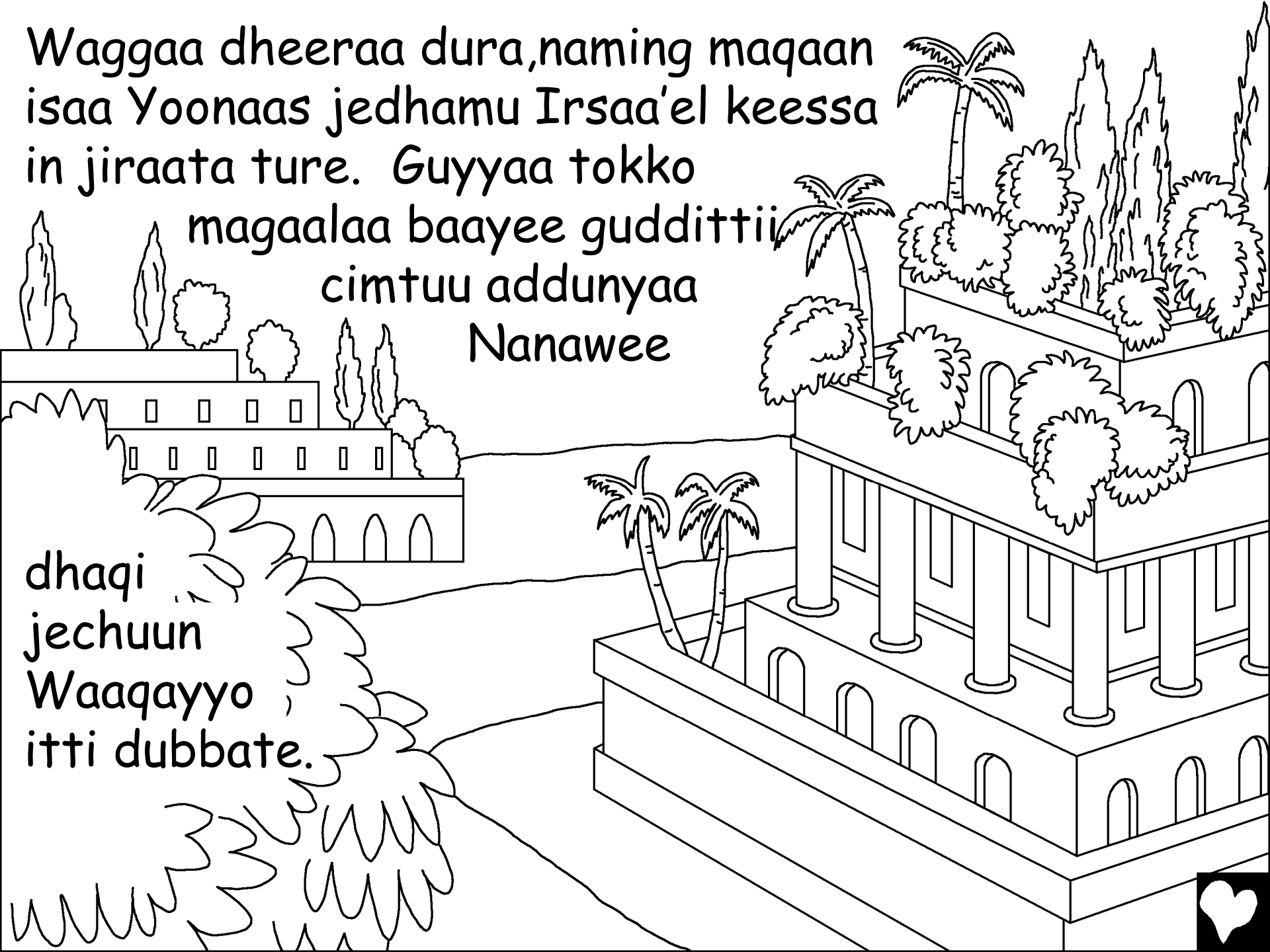

Namooti achi jiran cubbuu hojjechuu
Waaqayyoon bareef Yoonaas akka
isaan akeekkachhisuuf itti eege
Waaqayyo.

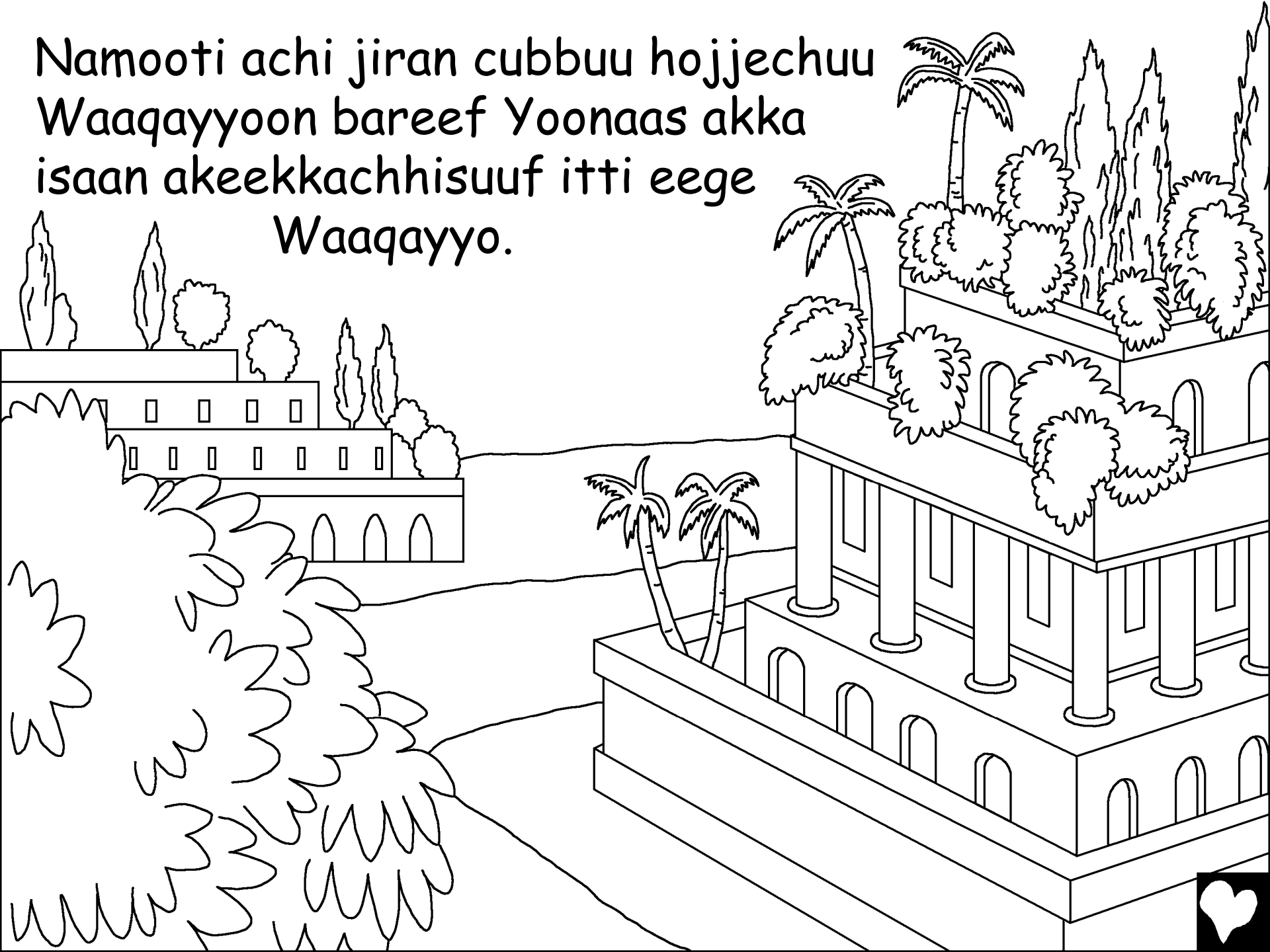

Yonaas Waaqayyooof
abboomamuu dide!
Nanawee dhaquu didee
bidiruu yaabbatee gara
faalla ishee bakka
Tashiishitti deeme.

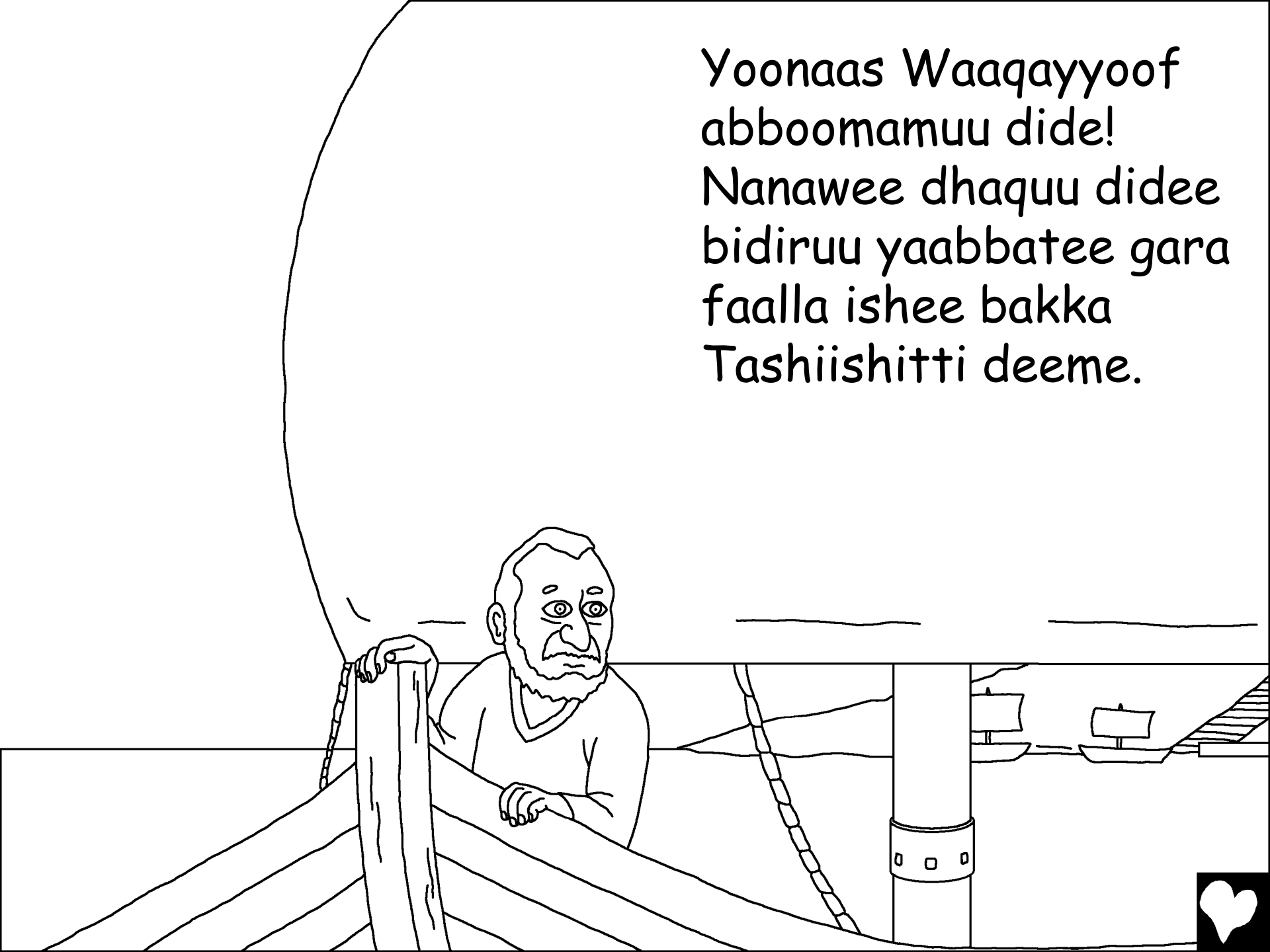

Waaqayyo bidiruu inni ittiideemaa jirutti qilleensa
jabaa itti kaase. Hunkura guddaanis galaana irratti
ta'e! Qaamin bidiruu caccabuun galaanaan liqimfama
jechuun sodaa guddaa keessatti kufan.

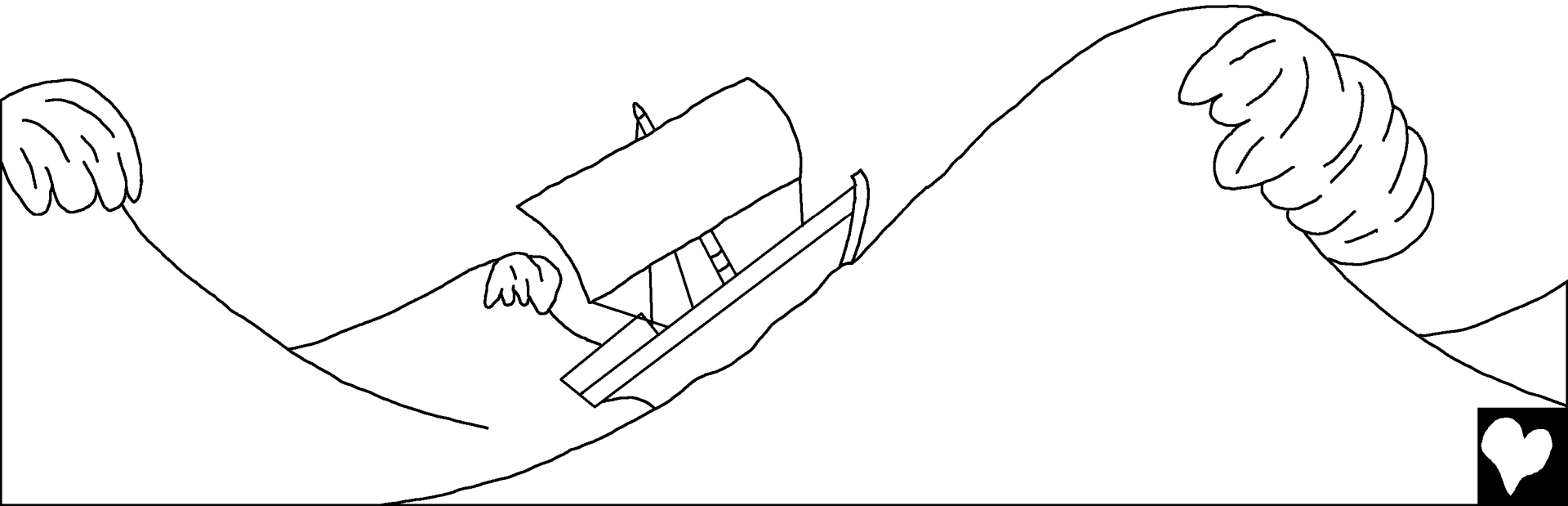

Hunkuramin galaana irraa dabalaa dhufe. Kan bidiroo sana keessaatti argaman du'a ooluuf in kadhatan, ba'aab akka salphatuuf waan bidiruucha keessaa gad darbatan. Garuu waanti fooyya'e hin turre.



Namoota hundumaa bidiruu sana keessaa kan hin kadhanne Yoonaas gofa ture. Kadhachuun hafee bidiruu keessa rafee ture. Kaappiteenni bidiruu sanaa isaa rafa jiruu isa arge. "Maal hojjechaa jirta rafa jirtaa? Ka'i! Waaqa kee kadhadhu jedheen! Waaqayyo nuyaadachuu danda'a, badiisas in oolla."



Namootin bidiruu keessaa sodaan guutaman
sun Yoonaas waliin rakkoon tokko akka jiru
adda baafata. Yoonaas Waaqayyo irraa akka
baqachaa jiru isaanitti hime.

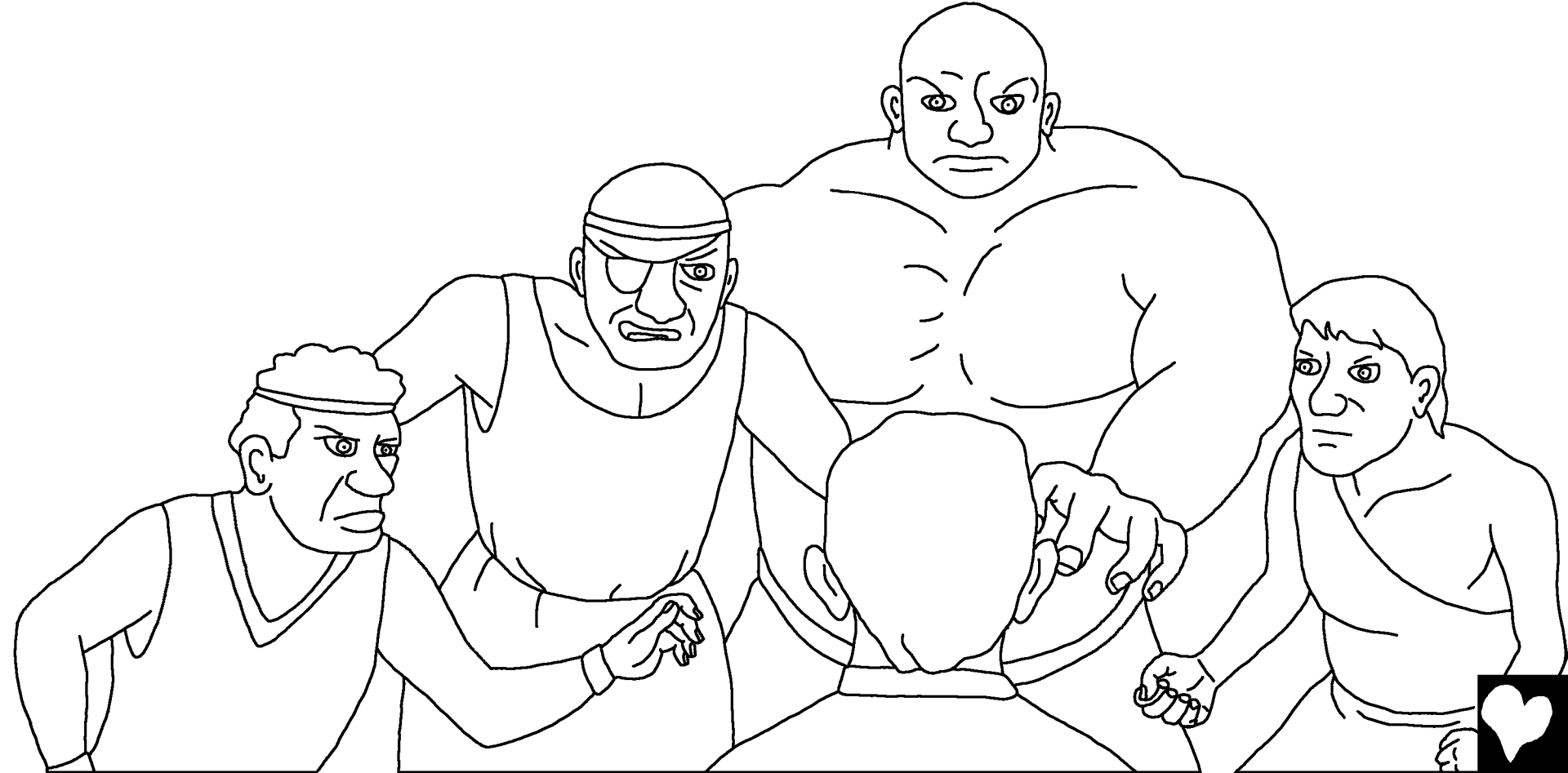

"Waa'ee keef maal goonu jedhanii gaafataniin?
Hunkurama Galaanichaan akkamitti gab nuuf jedha?"
jedhanii gaafata. "Ana fuudhaatii galaana keessa
nabuusaa!" Yoos galaanichi isin irraa gab in jedha;
bubbee humna qabeessi isinitti ka'e kunis sababa
kootiif ta'uusaa anoo
beekeera," jedhee
isaaniin deebise.

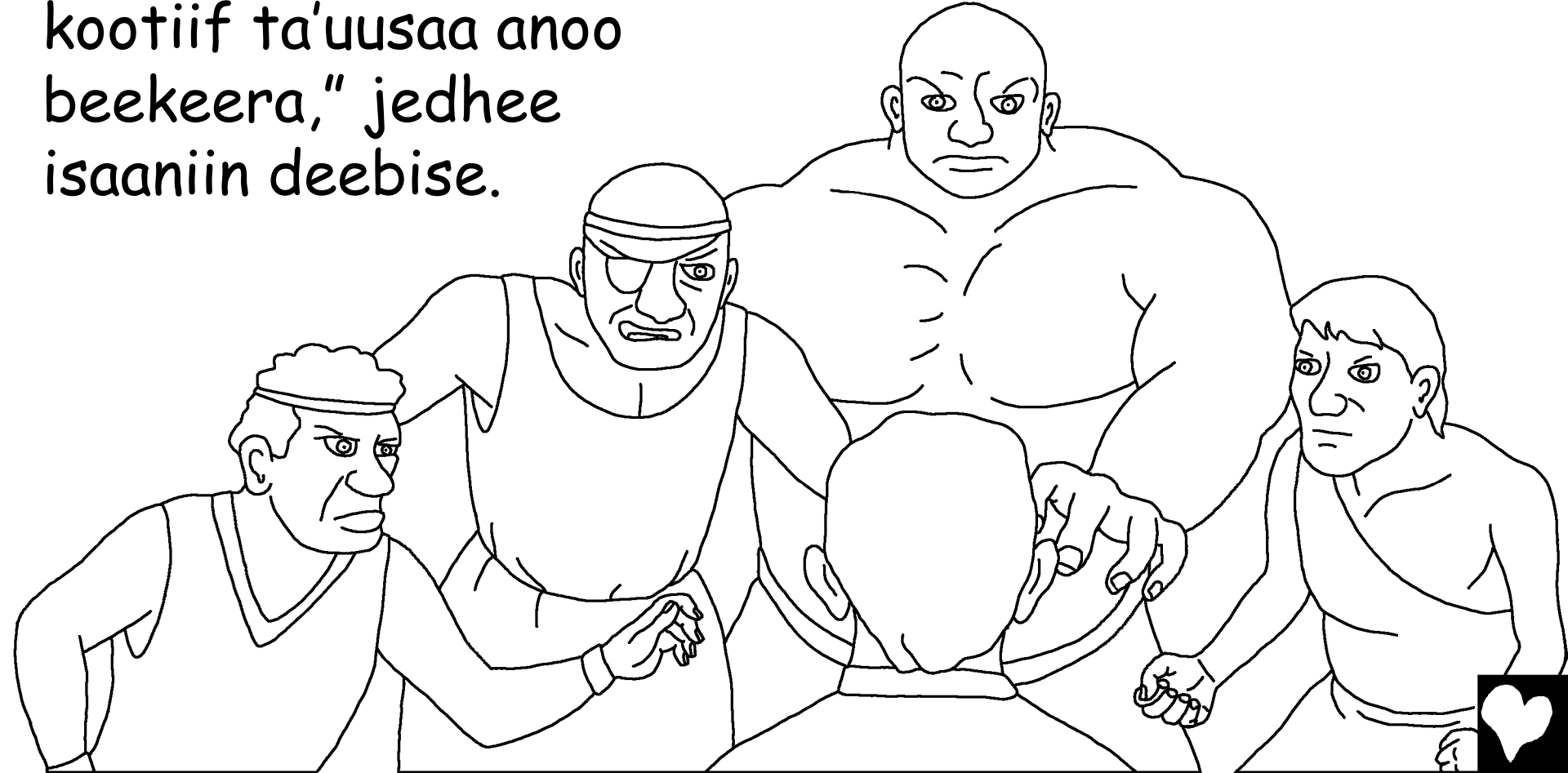

Jaarris bidiruu sana
gara lafaatti baasuuf
jabeessanii in mooqan;
garuu hunkuramuun
galaanichaa isaanitti
dabalaa waan
adeemeef, waan
tokko qofaa
gochuu qabu ture.



Kadhata dhiifamaa erga kadhatanii booda,
Yoonaasii fuudhanii galaanichatti
gad darbatan
galaanichi
hunkurama
isaa in dhaabe.

Battalumatti jijjiirama
qilleensaan gadda hunkurama
duraa caalu keessatti kufan.
Waaqayyo duwwaatu beeka
kan raawwates Waaqa.
Sodaa fi dinqisiisfannaa
keessa ta'uun
Waaqayyoon waaqessa.



Yeroo gababaa keessati,
ergamaan abboommii
dide misiraachoo
guddaa argate.

Keessagalaanaatti gadi
liqimfamuun, Yoonaa
eenyu illee galaanaan
liqifamuu irraa akka
isa hin oolchine in
beeka ture. Carraa
inni qabu liqimfamuu
qofaadha - Waaqayyo
garuu karoora biraa qaba ture.

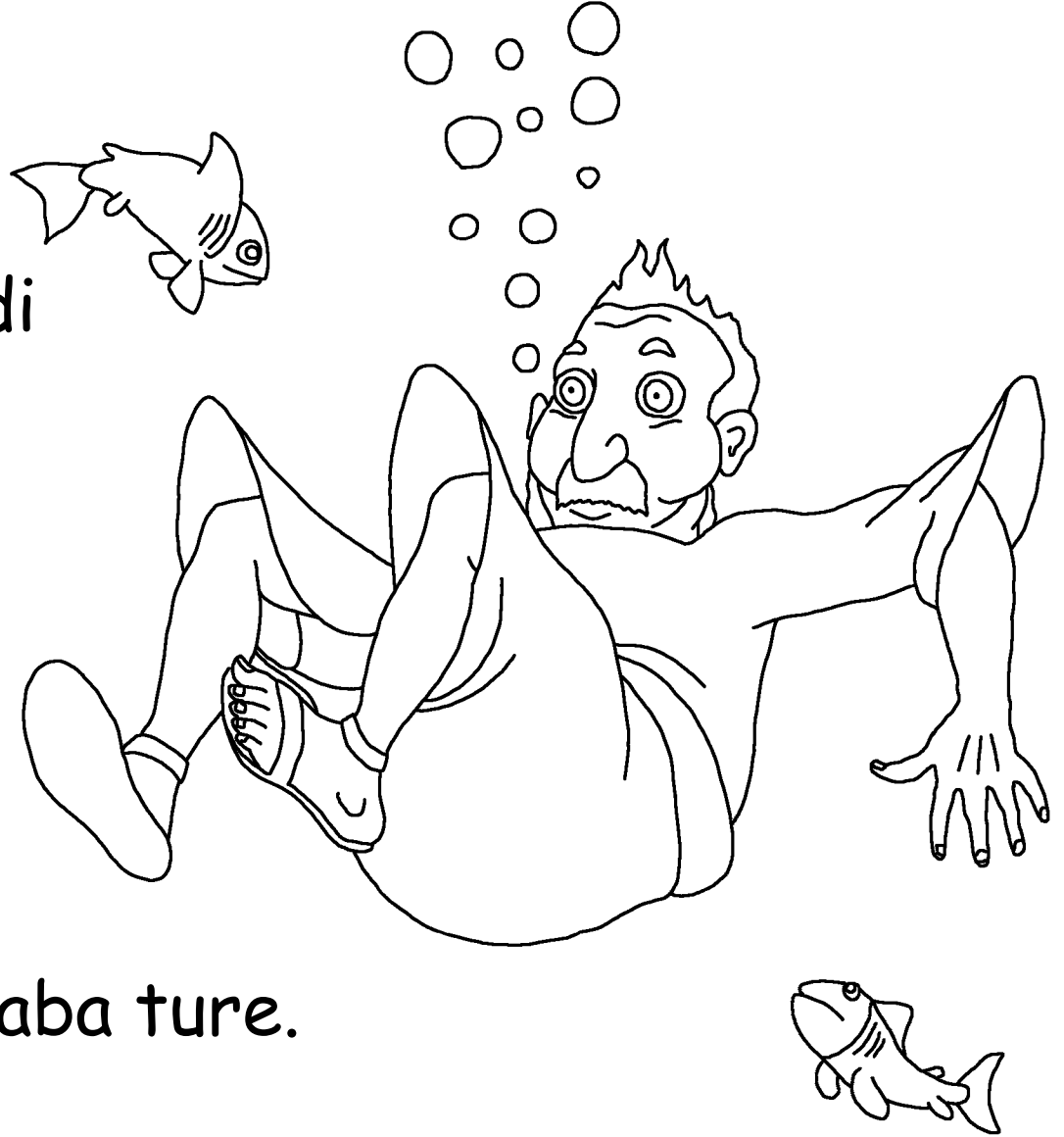

Waaqayyo qurxummii guddicha Yoonaasiin liqimsu
qopheessee ture. Qorxummichi jalqabatti
sirrii ture! Garaa qurxummii keessaa
Yohaannis guyyoota sadiif taa'e.
Yeroo kadhatuu fi yaaduu isaa dhabe.



Guyyaa sadiin booda, Yoonaas Waaqayyoof
abboomamuu eegale. Daandii sirrii yeroo inni
qabatu Waaqayyo qurxummichatti dubbatu
Yoonaasiin qarqara galaanaatti isa balaqame.



Yeroo jalqabaa isa dhumaa, Yoonaas Nanawee deemee dubbii sagalee Waaqayyoo akka lallabu itti hime. Yeroo kana Waaqayyo gara sanatti qajeele! Yoonaas magaalaa Nanawee seene, sagaleesaa olkaase, "Guyyoota afurtama keessatti Nanaween in garagalti."



Warri Nanawee dhaamsa Waaqayyoo kana amananii fudhatan; dhiifama cubbuu isaaniif gurguddoonni xixinnaanis akka soomaan labsan, uffata gaddaas in uffatan. Mootiin illee Waaqa duratti gad of deebisuun teessoo isaa irraa bu'uun uffata isaa isa suura qabeessa ofi irraa fuudhee, uffata gaddaa uffatee daaraa keessa in taa'e.



Waaqayyo isaaniif in dhiisaa! Karaa isaanii isa
hamaa irraa deebi'uu isaanii in arge; inni
waan hamaa hamaa isaanitti

fiduuf
dubbate sana
in dhiiseef,
irrattis
hin fidine.



Guyyaan sunis isaaniif guyyaa gammachuu
fi Waaqayyoo dhiifama isaaniif gochuu itti
hubatan ta'us garuu waa'ee
kanaaf
baayyee
dallanee,
aaree in
boo'es Yoonaas!



Yoonas maaliif aare? Waaqayyoon akkas jedhe,
Ati Waaqa araara qabeessa, o'a qabeessa, aariitti
suuta-jedhaa waan taateef hamaa fiduuf jettes
in dhiifta; ani kana beekkeen harka si dursee

Tarshiishiitti sokke. Jecha
biraan, warra cubbuu isaanii
beekanii araaraa kadhatanii
fi abboomamaniif Waaqayyo
yeroo hundumaa dhiifama
akka godhu Yoonas beeka.

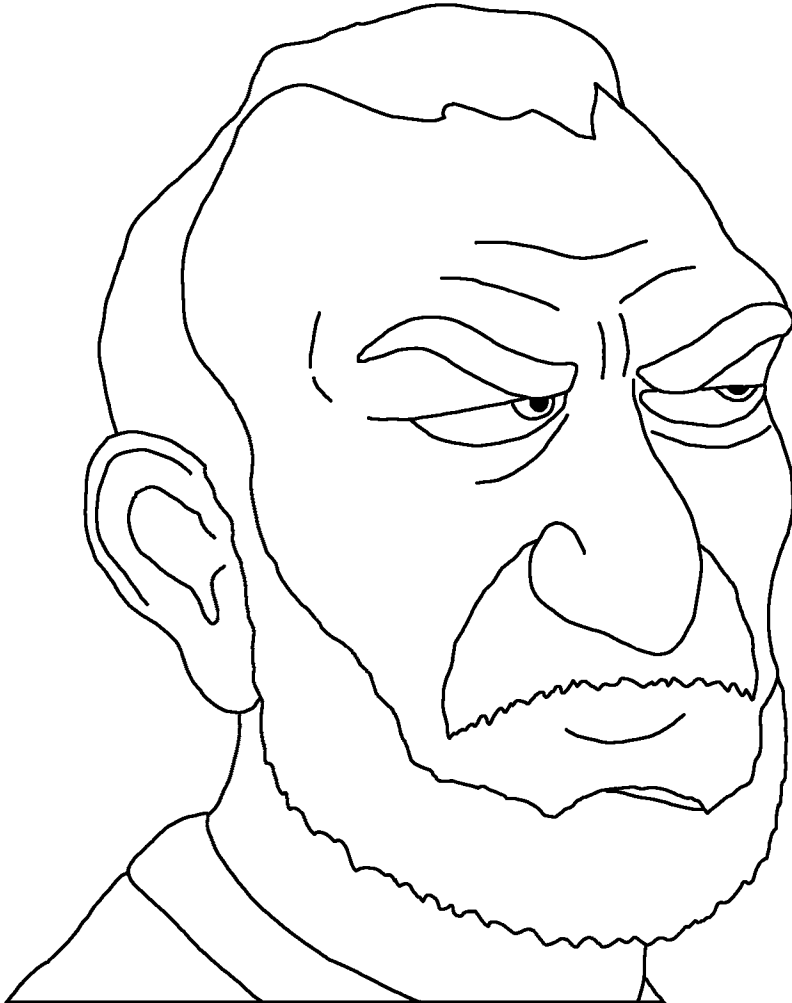

Waan Waaqayyo jedhetti Yoonaas in aare.
"Lubbuu koo fudhadhu jiraachuu koo irra
du'atu anaaf ta'a," jedhe.



Yonaas magaalaa ala taa'ee, waan Waaqayyo
ittaansee raawwatu ilaauuf eege. Bqilaa baala
baayyee qabu qopheesse Waaqayyo. Saffisaan
lalisee, Yonaasiif gaaddisa
ta'uun gubaa aduu irraa
yeroo hundumaa isa ittise.



Borumtaa isaa, Waaqayyo raammoo biqiloota
gokisu erge biqiltuun sunis in goge. Isa booda
Waaqayyo qilleensa ba'a-biiftuu inni gubaan
akka isatti qilleensa'u in godhe; aduunis hamma
Yonaasiin gaggabsutti mataa isaa araane;
yammus inni, "Jiraachuu irra du'uu anaaf wayya,"
jedhe du'uu in hawwe.



"Ati waa'ee biqiltuu sanaaf aaruu
intolchitee?" Waaqayyo Yoonaasiin
jedhe. Ati biqiltuu waan tokko
itti hin dadhabin, isa hin
guddisiniif, isa halkan

tokkotti ba'ee
halkanuma
tokkotti immoo
badeef in gaddita.

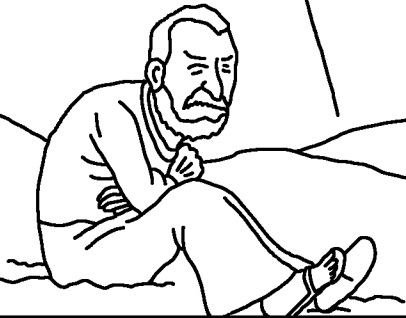

“Egaa ani immoo maaliifan mandara gudditti namoonnii kumaatamaa fi horiin hammasii keessa jiraatan Nanaweef maaliifan araara hin taasisuree kanaaf garaan ana hin jibbuu ree?” jedhe.



Yoonas fi Qurxummii Guddicha

Seenaa Sagalee Waaqayoo Macaafa Qulqulluu

kan keessatti argamu

Yoonas

"Saaqamuun dubbii keetii ifa in kenna."

Faarsaa 119:130



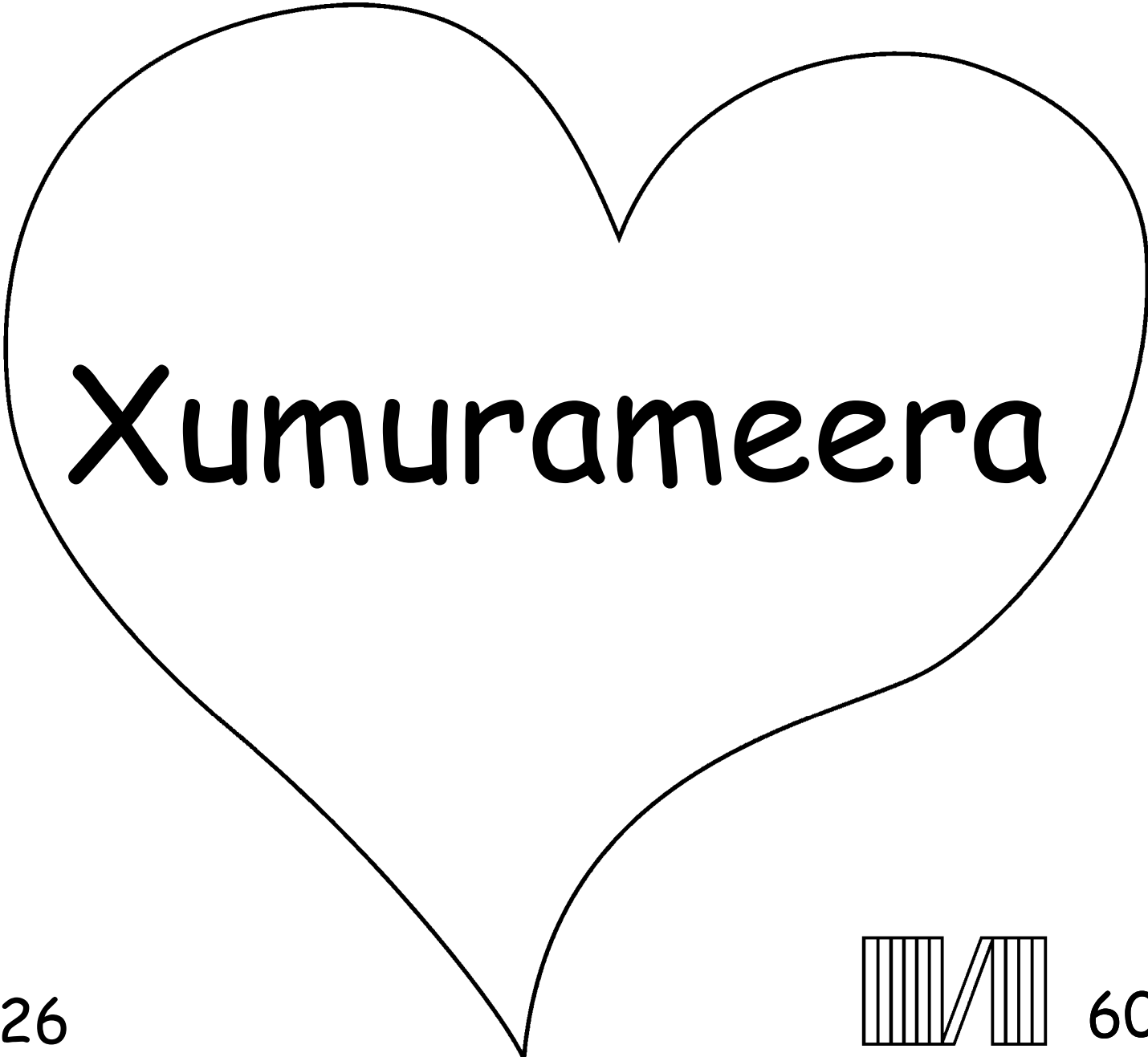

Xumurameera



26

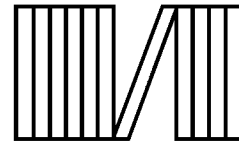

60



Seenaan Macaafa Qulqulluu kun kan haasa'u waa'ee Waaqayyo keenya
Isa dinqii Isa nu uumeefi Isa akka Isa beeknu barbaaduuti.

Waaqayyo wanta hamaa isa Inni cubbuu jedhuun akka raaw'anne ni
beeka. Adabbiin cubbuu du'a. Waaqayyo garuu guddaa si jaallata,
kanaaf cubbuu keetiif akka fannoorratti du'uufi akka adabamuuf
Tokkicha Ilma Isaa Yesuus dabarsee siif ni kenne. Sana booda Yesuus
gara jireenyaatti deebi'ee gara iddoo jireenya Isaa gara Waaqaa ni
deeme! Yesuusitti amantee cubbuu keetiif akka siif dhiisuuf yoo Isa
gaafatte, Inni siif ni dhiisa! Yeroo kana dhufee si wajjin ni jiraata,
akkasumas immoo atis Isaa wajjin bara baraaf ni jiraatta.

Inni kun dhugaa ta'uu isaa yoo amante, Waaqayyoon akkas jedhiin:
Yaa Yesuus, Ati Waaqayyo ta'uu kee fi cubbuu kootiif du'uuf jettee
akka annaf dhufte nan amana, ammas kunoo deebitee ni jiraatta.
Maaloo gara jireenya kootti koottuutii amma jireenya haaraa akkan
jiraachuu akkan danda'uufi guyyaa tokko sin wajjin bara baraaf
jiraachuuf gara kee akkan dhaquuf cubbuu kootiif naaf dhiisi.
Abboommii kee akkan eeguufi akka mucaa keetti akkan jiraadhuuf
na gargaari. Ameen.

Macaafa Qulqulluu dubbisiitii guyyuma hundumaa Waaqayyoo
wajjin dubbadhu! Wangeela Yohaannis 3:16

