

www.BibleForChildren.org

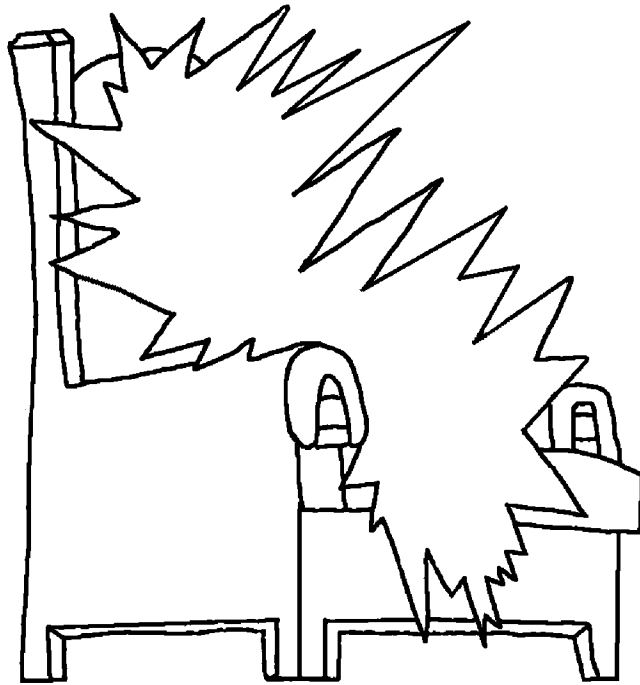

Yaolhaq 14



Yeiqsul aqyu juq bhai ge bhiq-a nail: "Nul juq nail
neema bhai haq aoq thaq nl. Miqyail bhai neema thaq
tsaol yaoq, ngaq bhai iqsanl neema thaq tsaol yaoq.
Ngaq nail Aqbhu nail ilkhaol bhai jaol duq jiav gao
nail ngaol.

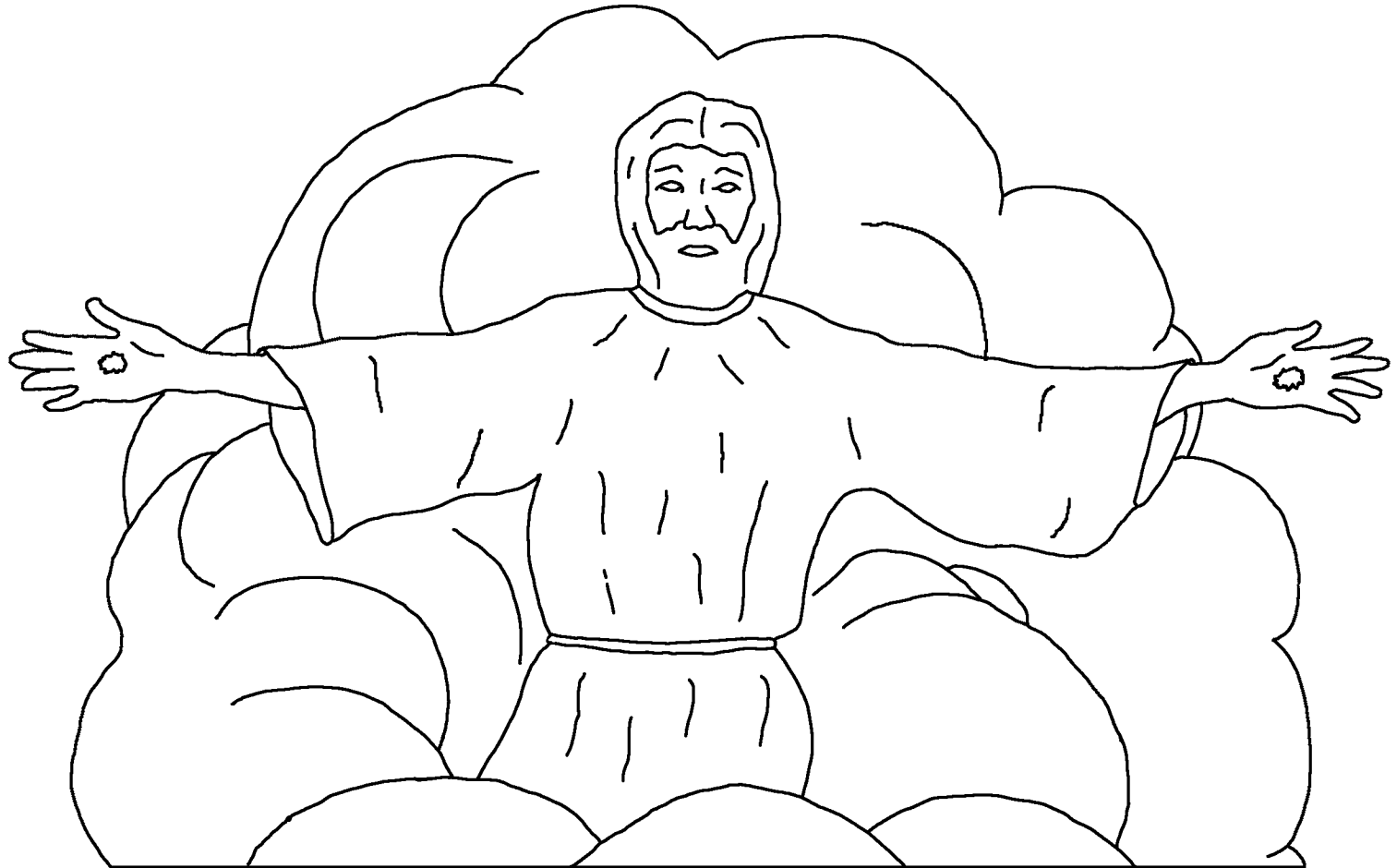

Ngal nul juq nail haqbhoil jaol duq lav sav lai naol.
Jaol duq maq jiav-ail nul neq, maq jiav-ail dai, ngal
daol coev dai, ge bhiq nail ngaol. Ngal jaol duq lav sav
gaq-u phao, nul juq bhai gaoq hevq lee khi, ngaq-ai
nee mail bhi jaol lal naol."

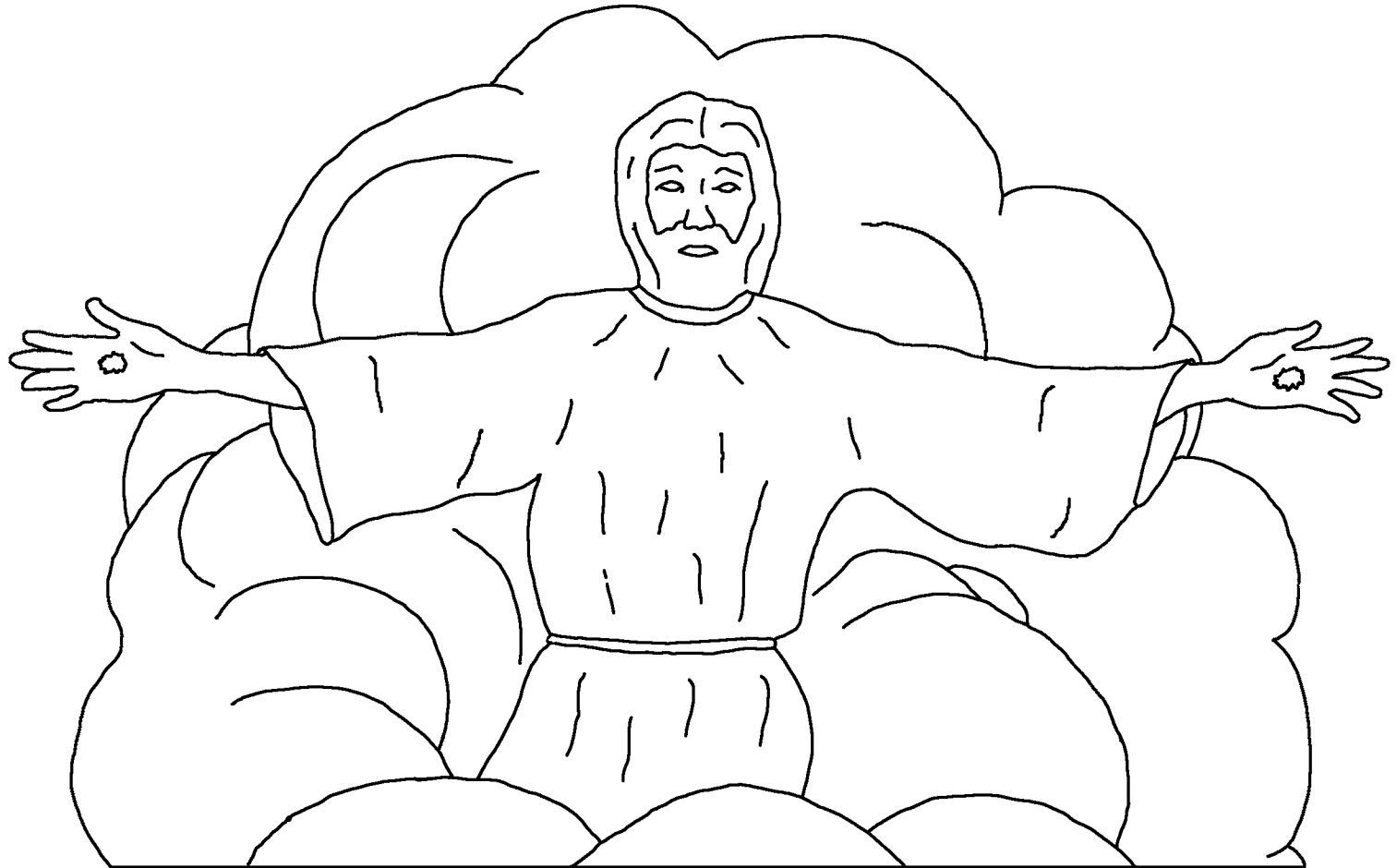

Ngal neq, nul juq nail aqivq jaqbheq Yaol haq
ngaol. Khoeq nail pha q bhai maqkhaiq, Miqyail
Milkhaoq bhai maqkhaiq, ol nail pha q

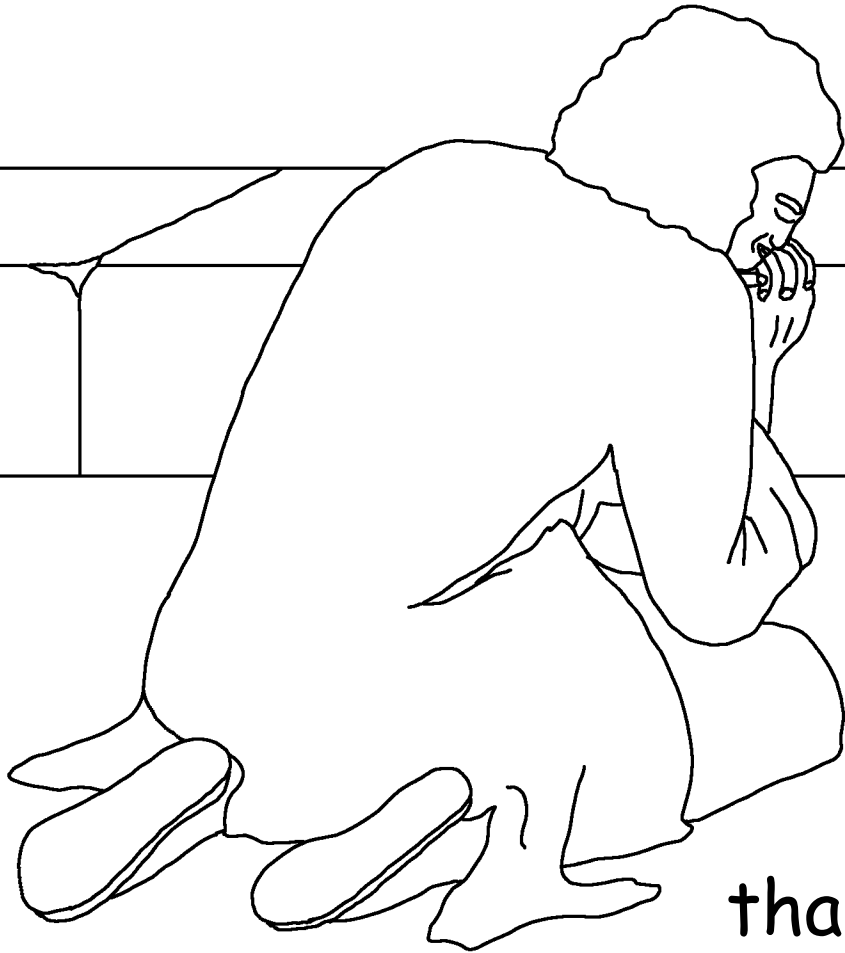

bhai maqkhaiq,
Yeiqsul nail
lavqkhoel ngal nul
juq nee mail daq
thail thaiq nail ngaol.



Ngal Miqyail nail daoq cavq cavq ail, Yeiqsul nail
ganl salkhil khanq nail bhaq da nee, Bhaqmol
khul nail eel jaollaol-n bhai bhi nieil

dai aivq-a nail ngaol.

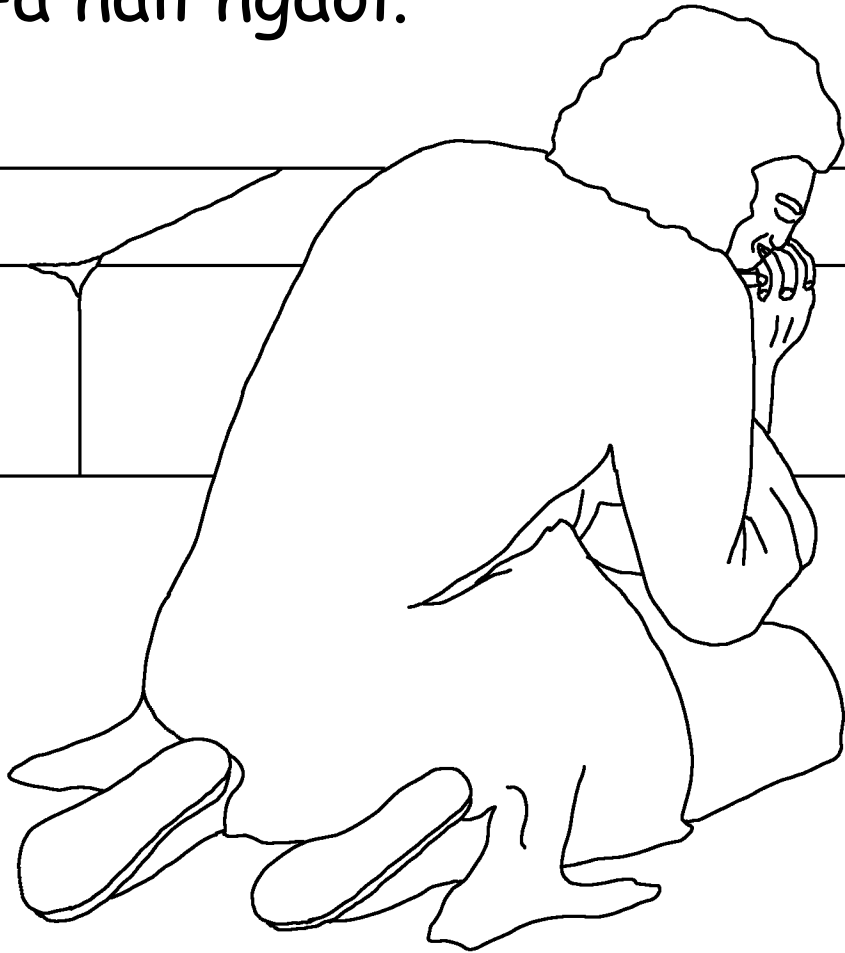

Aq-u phao, teevq pov taivq-ail, Aqhaqlal Miqyail ngaq
bhai uv thaiq lee-a nail ngaol. Hel daiq dei-eiq. Nqtavq
kovtavq bhair doiqbev bev ma jlav nail bhair maqkhaiq,
doiqbev bev ma al bhair teevq gaq jaol deel-nvq thaq
nail bhair maqkhaiq, ngal
ya moel-a nail ngaol.

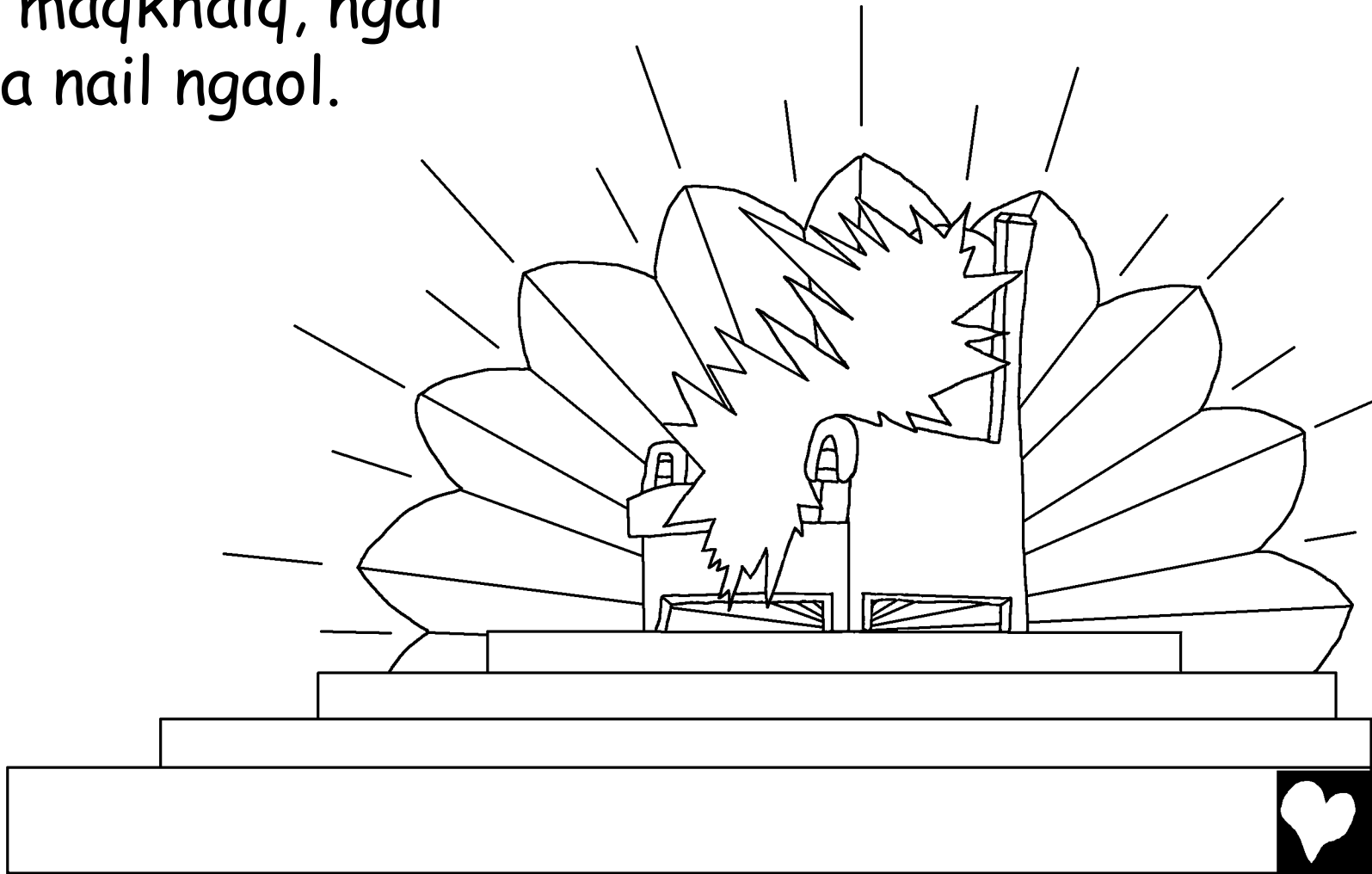

A bhai nee ngal-aq, nqtavq kovtavq bhai jaol nail juq
maqkhaiq, miltsaq bhai jaol nail juq maqkhaiq,
miltsaq kov-uvq bhai jaol nail juq
maqkhaiq, iqyaaq iqma bhai jaol
nail juqmaqkhaiq, al juq iqsanl
mail niail hai ge nail bhai ngal
ya gaiq-a nail ngaol:



“Joiqjaq doiqbev bev ma bhai jaol deel-nvq
thaq nail gaq bhai maqkhaiq, Yaolyaq bhai
maqkhaiq, nqmaq maqluv halyeel
tsiq eeq nail phaqaq, ev nail phaqaq,
seiqlaiq khaoqsail khi mail uv
thaiq nail bhaqaoq jiav dei-eiq”
dai, aqyu juq gul nail ngaol.

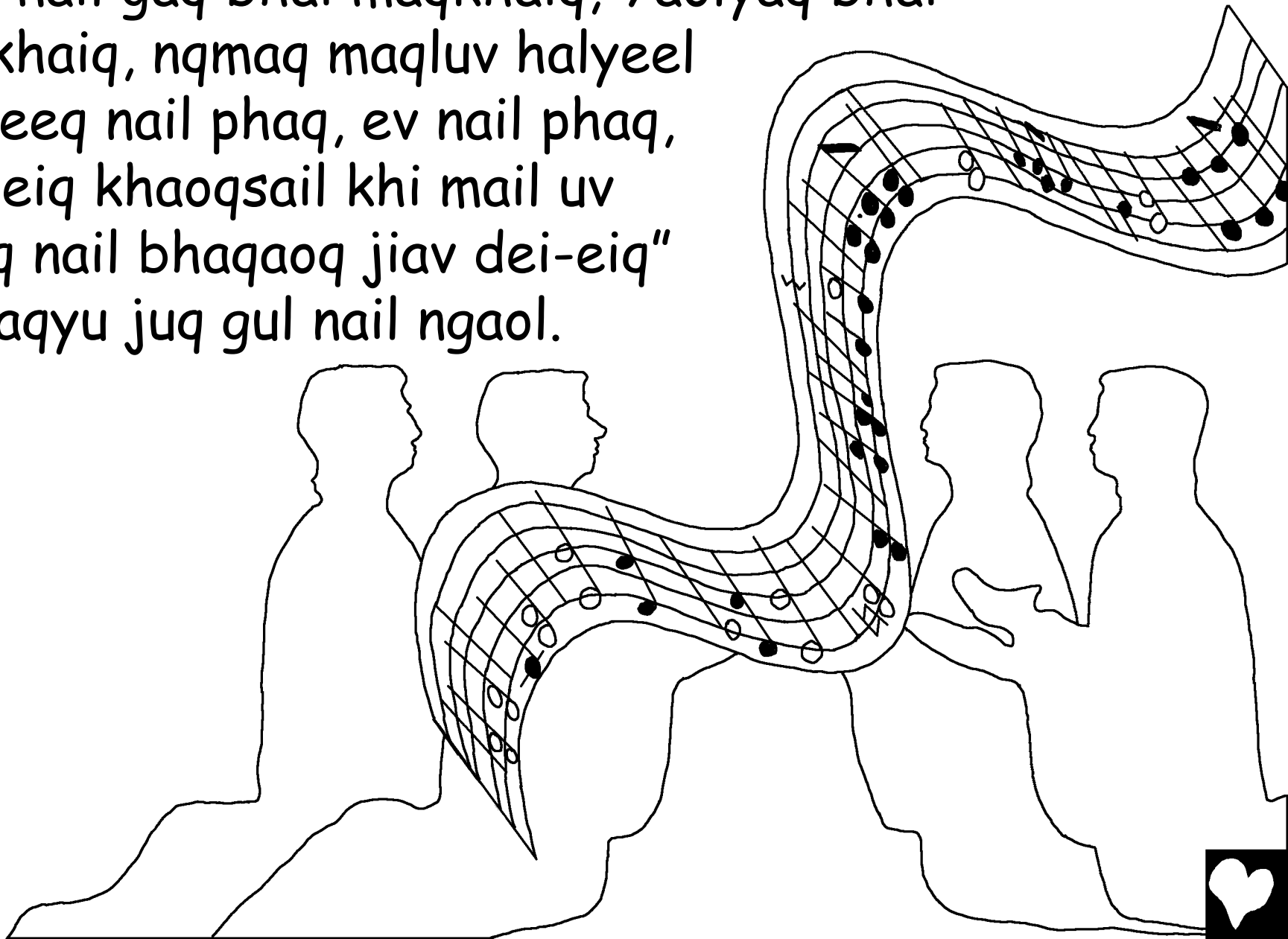

Aq-u phao, meeq nail haol nail Yeiglulsaqlaiq meenq
aqsivq Miqyail jaol nail nqtavq kovtavq nee yavq kha
lee thail thaiq nail bhai, ngal ya moel-a nail ngaol.

Meenq al meenq neq, maol ail nail yaqmai-aq yaqnoil
khe-ai,

aqmeeq-ai
lainq-ai thaq
nail ngaol.

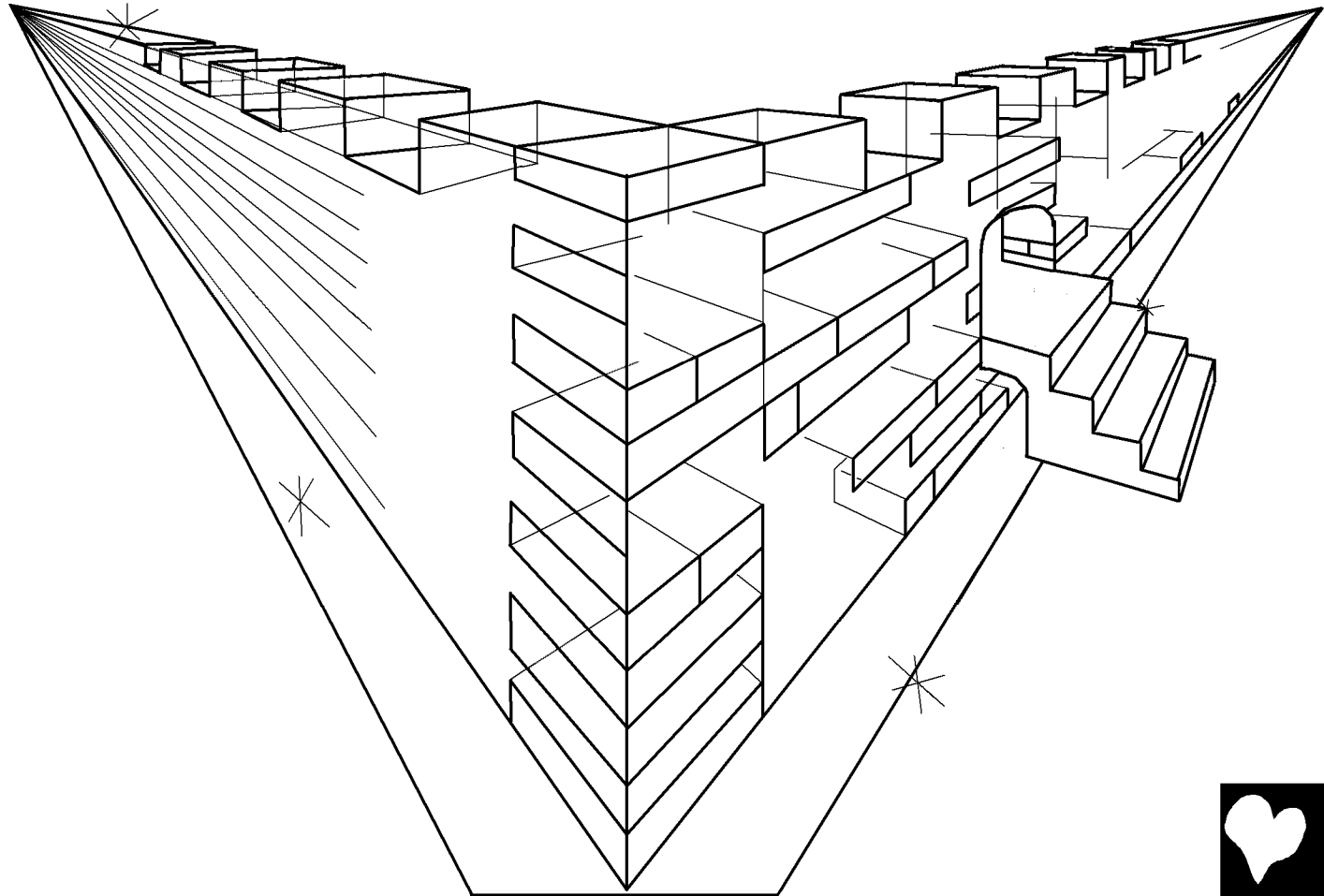

Doiq bev bev ma nee mail, kav dee dee nail aqthel gul
dov-ai leevq nail bhai, ngal ya gaiq-a nail ngaol. Aq
thel al neq, niail hai gul nail ngaol: "Hel daiq dei-eiq.
Miqyail nail jaol duq tsaol-aq jaol nail bha jiav lee khi,
aivq tsaol-aq yaq nee mail jaol nail ngaol. Aqyu juq

neq, Miqyail
nail tsaol-aq
pevq khi,
Miqyail iqsanl,
aqyu juq nee mail
jaol nail ngaol."

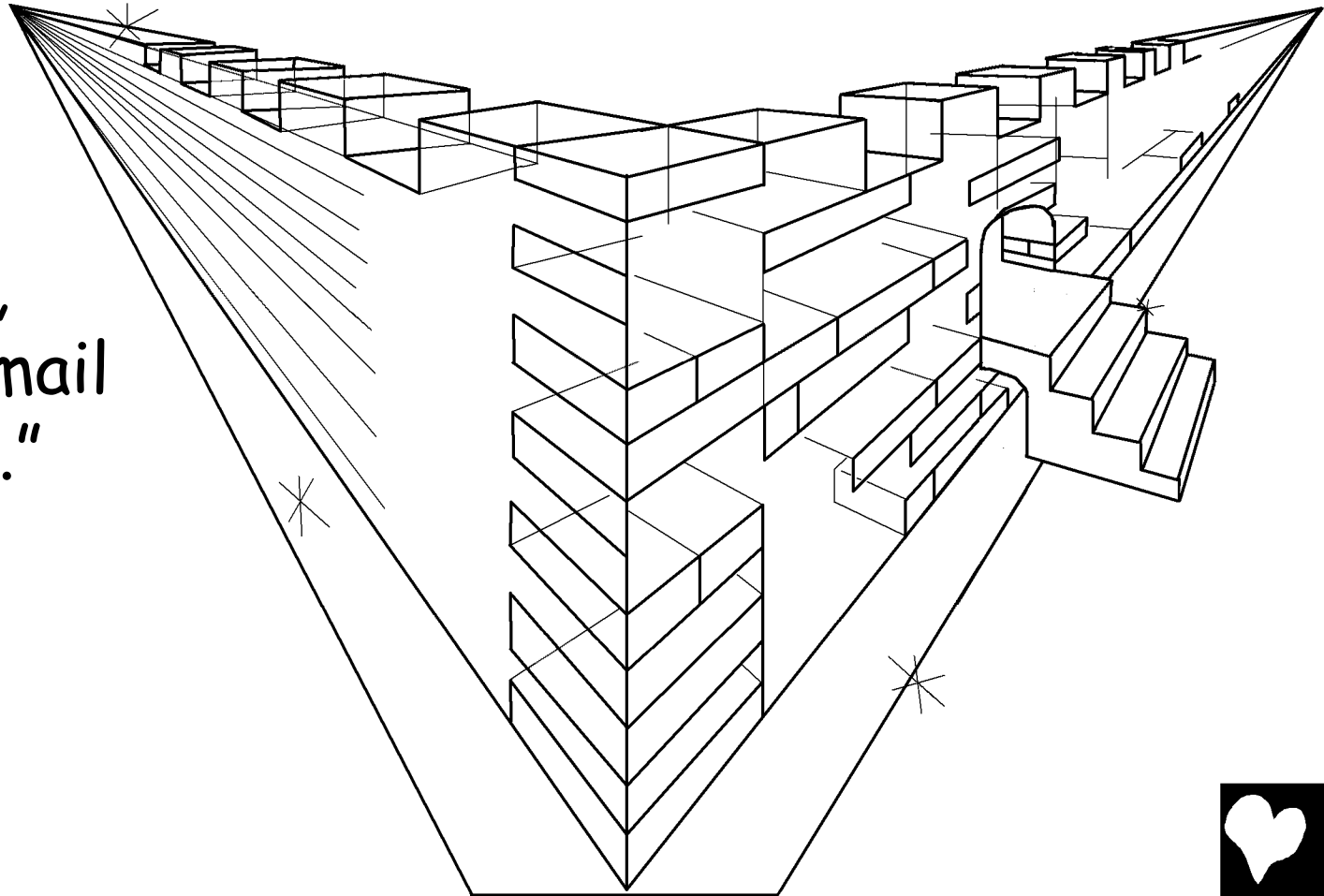

A bhai nee ngal-aq, nqtavq gaqkhoel al gaq, aqdoevq
bhi doevq nail laoljaol ngaq bhai cavq naq lavq-a nail
ngaol. Miqyail khi Yaolyaq nail joiq jaq doiqbev nee il
dov lee khi, sainl khe-ai dul nail haol taiv deel laoljaol
pevq nail ngaol.

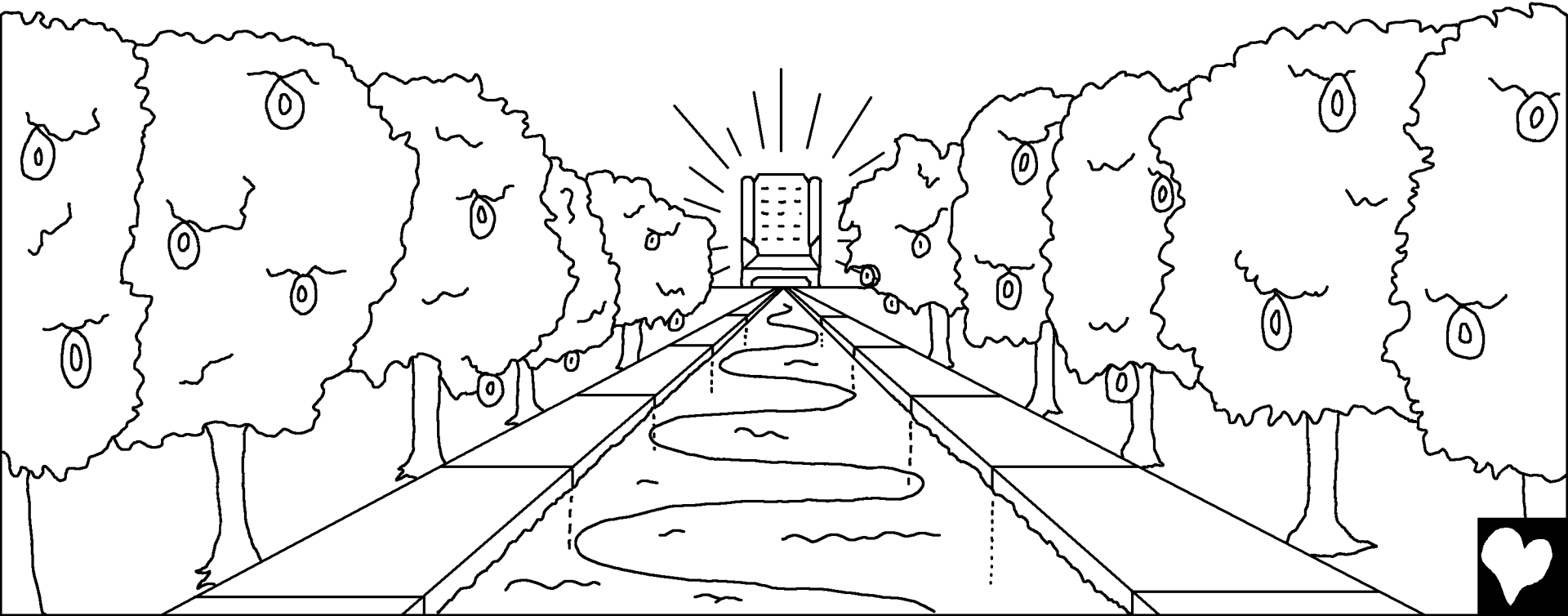

Meenq al meenq nail lavqkhoel bhai nlma nail aqbhaq khi bhala nail aqbhaq maq loq-ail. Khul khi mail dai ngal-aq neq, Miqyail nail seiqlaiq khaoqsail meenq al meenq bhai aqbhaq bhaq khi, Yaolyaq neq, meenq al meenq nail phalmanq pevq nail ngaol.

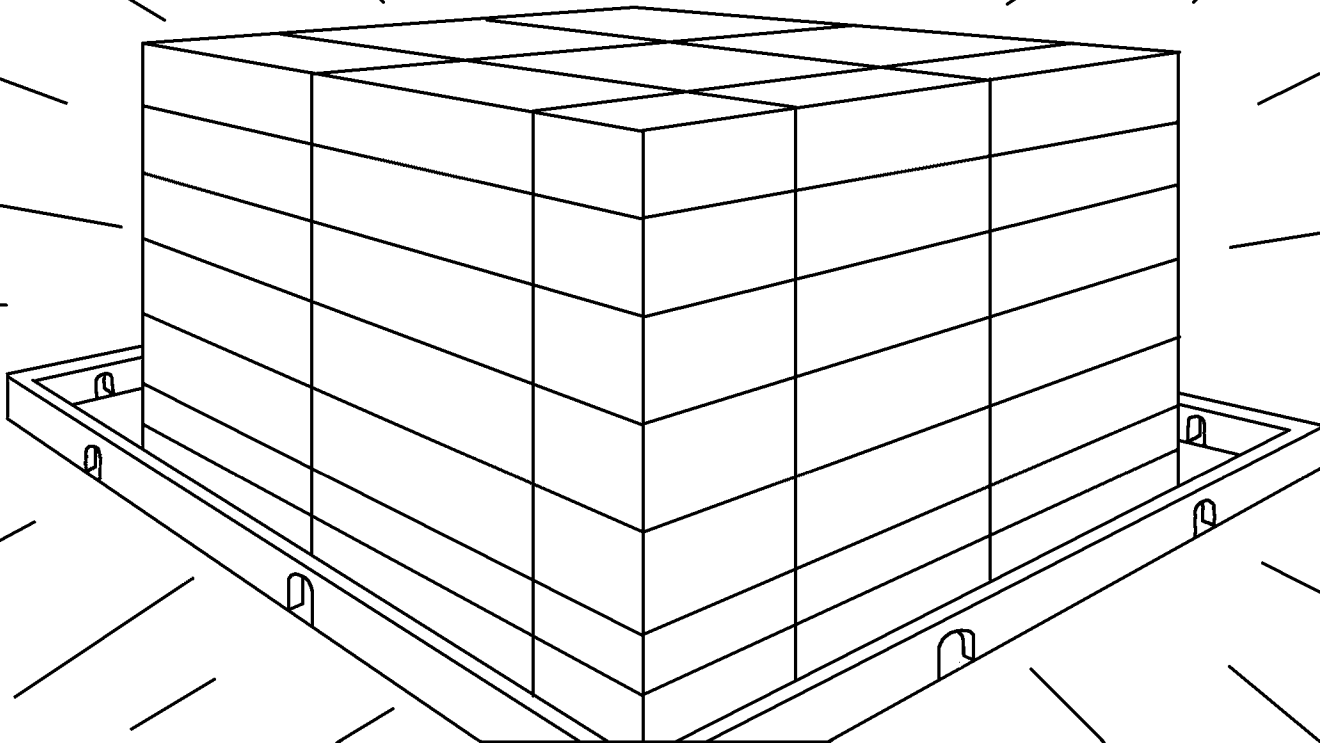

Aqjiivq aq cavq khul pha q maqkhaiq, meenq al meenq
bhai maq ya oil bhoel laivq-ail. Aqjiivq aq cavq pha q
nl-a nail tsaol-aq khi goiqbhaoq
bhaoq-a nail tsaol-aq khul
gaq maqkhaiq, meenq al
meenq bhai maq ya aol
lai-ail. Yaolyaq nail
aqdoevq bhi doevq nail
haoqqavq phaldoiq
lavqkhoel bhai aqmil
ge vq bhoel-ai tha q nail
tsaol-aq taivq-ail, ya aol
lai nail ngaol.

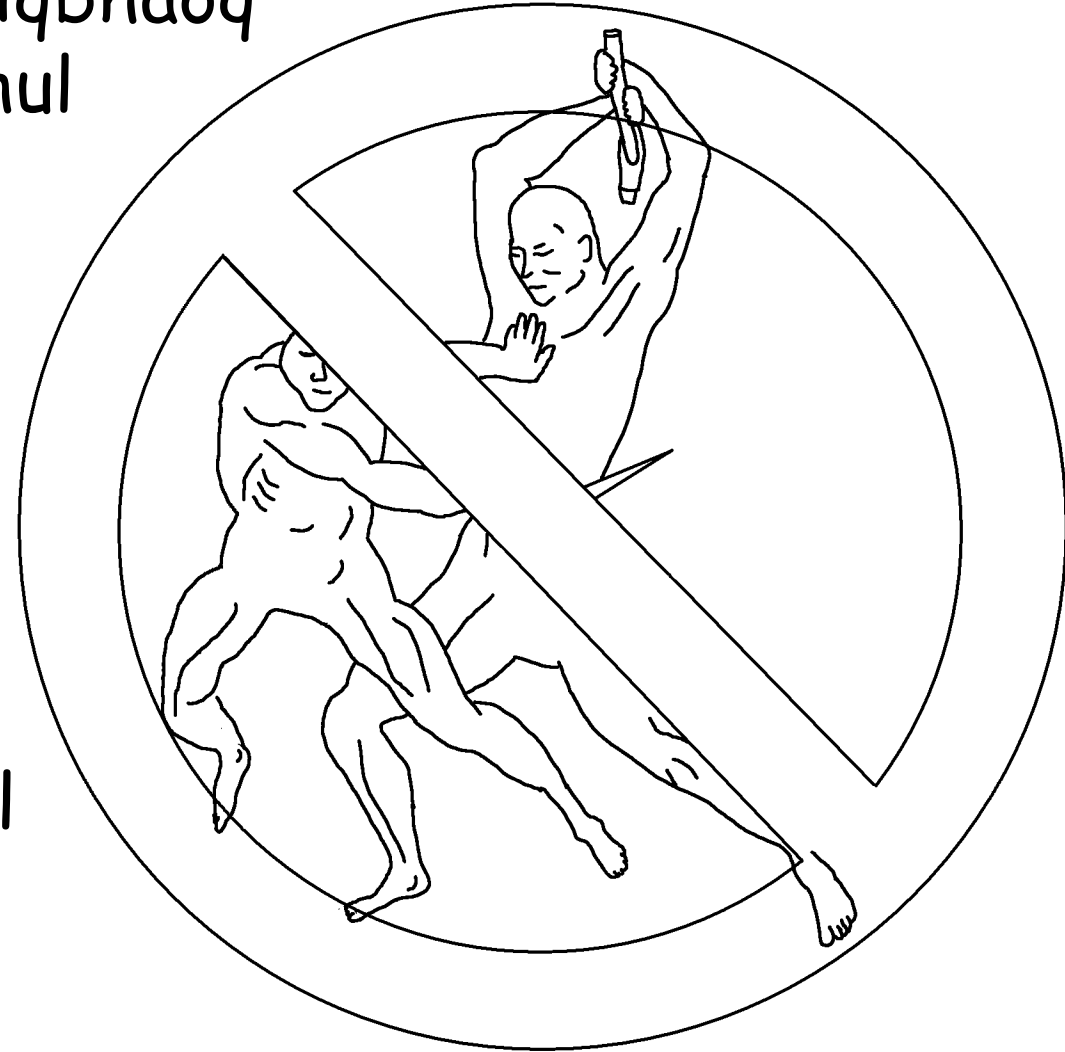

“Aivq aqyu juq nail maivbhil
iqsanl mail siv bhiq nail ngaol.
Sil nail phaqaq maq jiav yaoq-aol.
Noeq haq nail phaqaq, nioil khaoaq
khaoaq nail phaqaq, nal nail goel
nail phaqaq, niil juq iqsanl maq
jiav yaoq-aol. Khul khi mail dai
ngal-aq neq, iqmoeq-u phao
jiav-a nail juq peivq gil ail-aq
nail ngaol” dai, ge nail ngaol.



Niai nee pultavq neq, khul phaq maqkhaiq ivqkhail
yavq nail bhai maq ya daq yaoq-aol. Meenq al meenq
bhai Miqyail khi Yaolyaq nail joiq jaq doiqbev bev ma
jiav khi, aivq nail yaqkav juq aivq bhai uqhuq thaoq
nail ngaol.

Aqyu juq aivq nail
maivphaoq bhai ya
moel khi, aqyu juq
nail neeqthel
bhai aivq nail
aqmil gevq-ai
thaq nail ngaol.



Sil-a nail eeq yaq nil yaq iqsanl mail, doiqbev bev ma
al nail sivtavq bhai thul phaol-nvq thaq nail bhai, ngal
ya moel-a nail ngaol. Aq-u phao, haoqqavq juq phao-ai
thaq nail ngaol. Aq doevq bhi doevq nail haoqqavq
phaldoiq iqsanl phao-ai thaq nail ngaol.

Sil-a nail tsaol-aq juq-i mail nl-a hal-a
nail juq, haoqqavq al juq nail
lavqkhoel bhai gevq bhoel-ai
thaq nail khe-ai, gevq
bhoel-ai thaq nail al
juq bhai hel daiq hel
daiq ail, aqyu juq bhai
yalkhaq dal bhiq
nail ngaol.

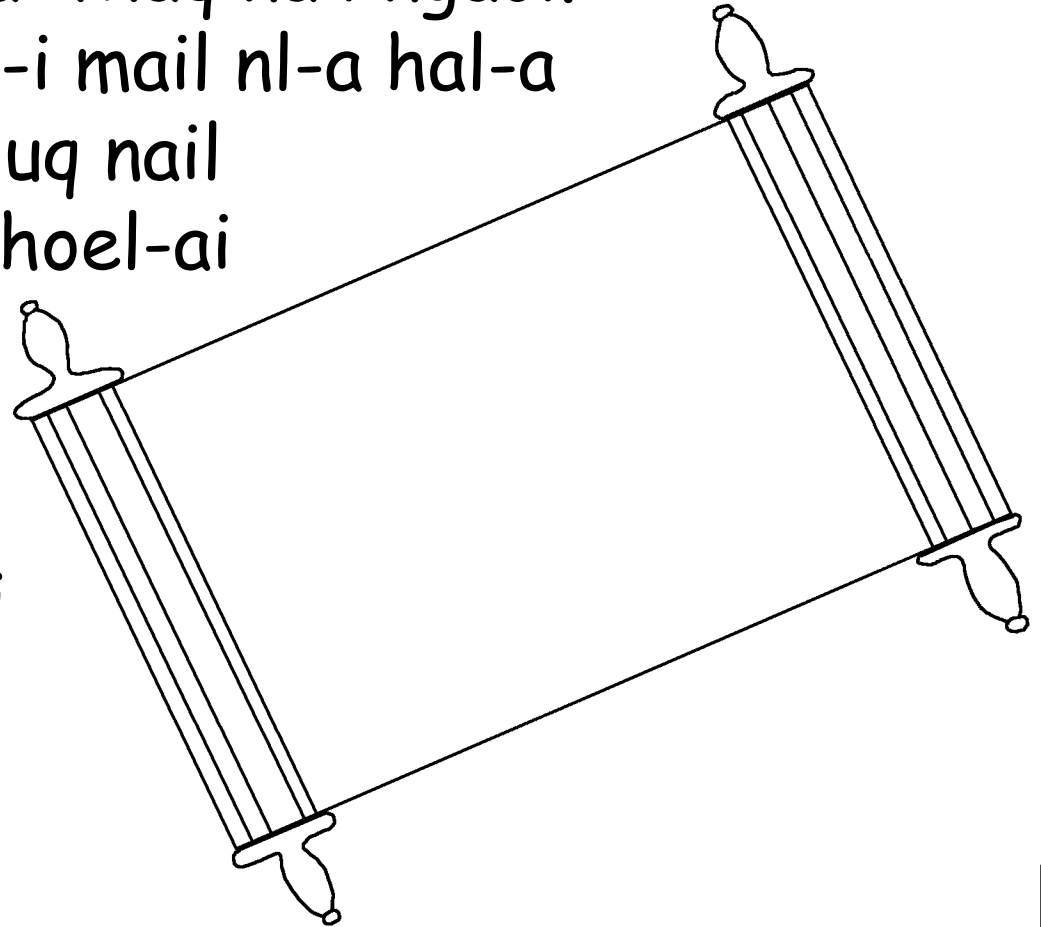

Aq doevq bhi doevq nail haoqqavq phaldoiq lavqkhoel
bhai aqmil maq gevq bhoel-ai thaq nail tsaol-aq iqsanl
bhai, miqjaq nail ngaqkha bhai, bavqpuvq
nail ngaol.

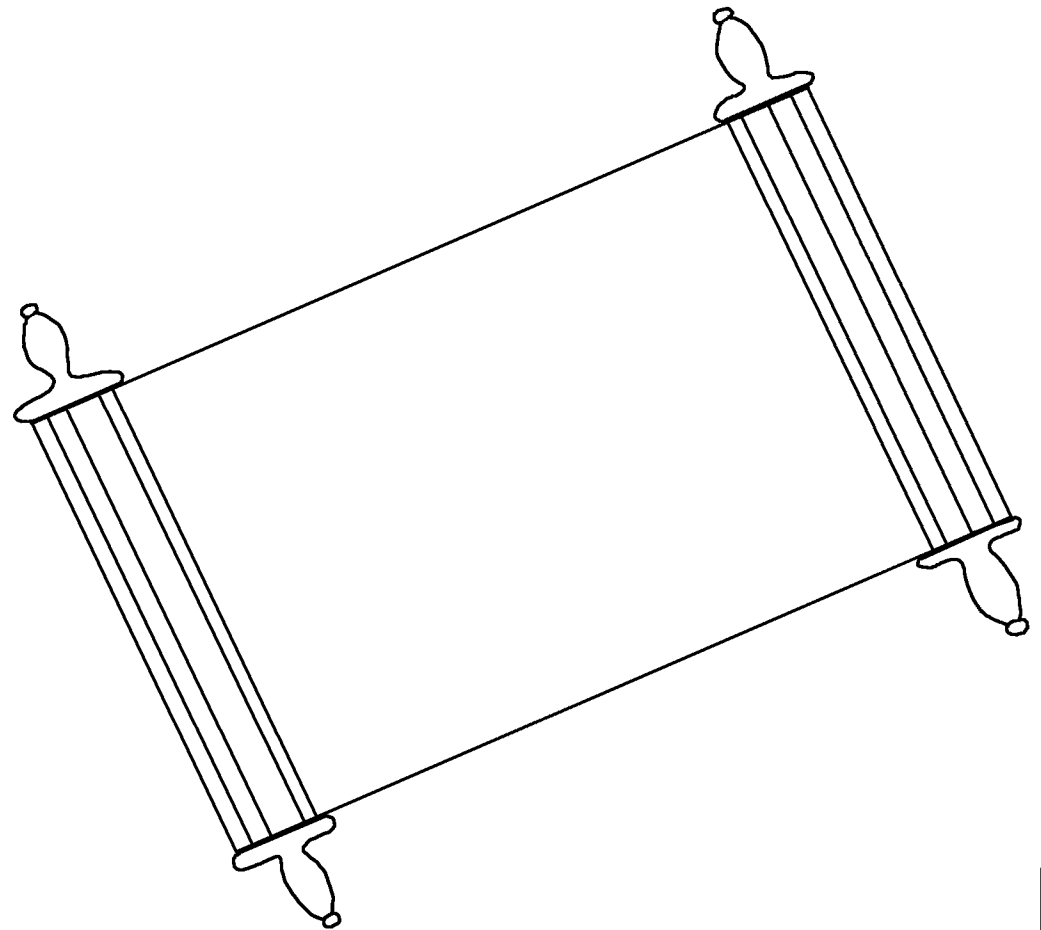

Aqhaqlal Miqyail khi, maol ail nail dai, lainq-ai thaq
nail yaqmai-aq al gaq, "Lal yaoq" dai, khul nail ngaol.
Khal ya gaiq-a nail tsaol-aq juq iqsanl mail "Lal yaoq"
dai, khul nail ngaol. Ulcuvq khal moevq nail tsaol-aq lal
yaoq. Khal daol movq nail tsaol-aq juq aqdoevq bhi

doevq
nail ulcuvq
aqnieivq ail
daol lal yaoq.

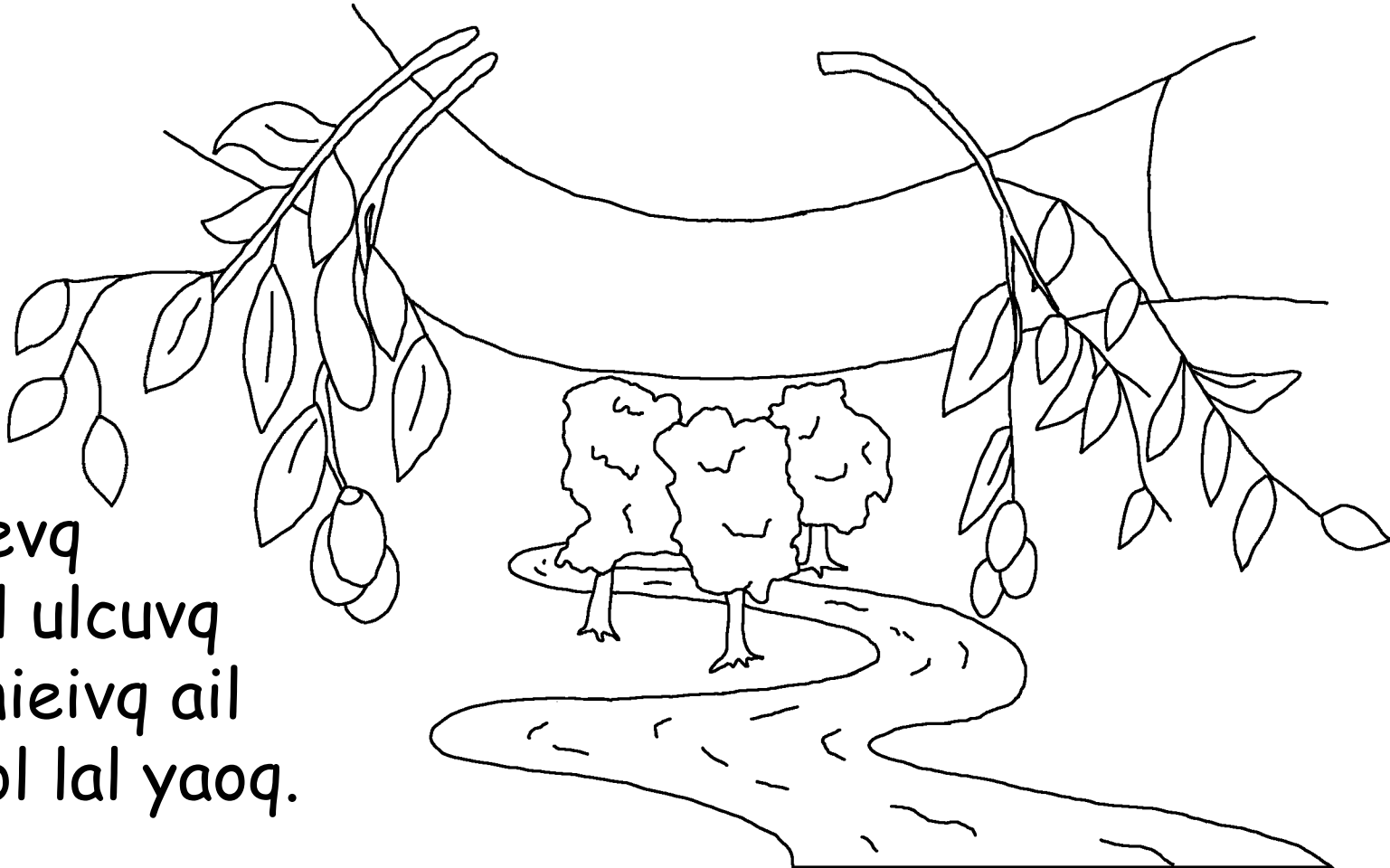

Yeiqsul gaoq ge nail: Miqyail miltsaq
yaq bhai gaiq-a dee dee nail ngel-i mail,
aivq nail Yaqyov teevq gaq teevq-eel
ngaol-aog, bivq lavq-a nail ngaol.
Yaqyov bhai neema khal thaq tsaol
nail tsaol-aq maq ya cov ail nail
nee ovqtavq, nqmaq maqluv
halyeel ya doevq
nail ngaol.



Lolmav 3:23 Khul khi mail dai ngal-aq neq, tsaol-aq iqsanl mail oeqbal nl-a nail ngel-i mail, Miqyail nail seiqlaiq khaoqsail bhai maq ya nia-ail.

Lolmav 6:23 Oeqbal nail aqphoiq neq, ya sil nail ngaol. Thail hai ngaol-aq, Miqyail-i mail ngadao bhai aqnieivq ail bivq lavq-a nail kovpavq neq, ngadao nail Heeqphaq Yeiqsul Khali bhaq da nee, nqmaq maqluv halyeel ya doevq nail ngaol.

Heiqbhail 9:27 Ngadao tsaol-aq teevq pov ya sil khi, yaqhao yalkhaq dal nail bhai ya daq nail ngaol.



Eilpheilsu 2:8,9 Nul juq neema thaq tsaol nail lavqkhoel Miqyail nail geeqlaoq eel jaol bhaq da nee, hevq kovq nail pha q ya-a nail ngaol. Yovqgavq bhai yovqgavq nl-a hal-a nail bhaq da nee ya-a nail maq ngel-ail. Miqyail-i mail bivq lavq-a nail kovpavq ngaol. Nl nail hal nail bhaq da nee ya-a nail maq ngel-ail. Al heel ngel-i mail, tsaol-aq teevq gaq iqsanl neema eeq duq maq jiav-ail.

Lolmav 10:9,10 "Yeiqsul neq, Heeqphaq ngaol" dai, naoq nail moeqthaoq khanq khi, "Miqyail aivq bhai bhi doevq kovq lal-a nail ngaol" dai, naoq nail neema lavqkhoel nee, neema thaq tsaol haq neq, Miqyail naoq bhai hevq kovq lavq nail ngaol. Neema lavqkhoel nee, neema thaq tsaol nail ngel-i mail, Miqyail nail sivtavq bhai tsaq nail daol nail tsaol-aq pevq lal khi, moeqthaoq khanq-a nail ngel-i mail, hevq kovq nail pha q ya-a nail ngaol.



Yaolhaq 3:16,17 Yeiqsul gaoq ge nail: "Miqyail miltsaq yaq bhai gaiq-a dee dee nail ngel-i mail, aivq nail Yaqyov teevq gaq teevq-eel ngaol-aoq, bivq lavq-a nail ngaol. Yaqyov bhai neema khal thaq tsaol nail tsaol-aq maq ya cov ail nail nee ovqtavq, nqmaq maqluv halyeel ya doevq nail ngaol.

Khul khi mail dai ngal-aq neq, miltsaq yaq bhai yalkhaq bhi dal nail dai khi, Miqyail aivq nail Yaqyov miltsaq bhai bhi lee-a nail maq ngel-ail. Miltsaq yaq bhai bhi hevq kovq lee-a nail ngaol."



1 Yaolhaq 5:11-13 Miqyail salkhil khanq nail al neq, ngadao bhai nqmaq maqluv halyeel doevq nail phaqaq bivq lavq-a nail ngaol. Nq maq maq luv hal yeel doevq nail al neq, aivq nail Yaqyov nail lavqkhoel bhai aol nail ngaol.

Yaqyov bhai hav bhoel nail tsaol-aq, doevq nail phaqaq ya nail ngaol. Yaqyov bhai maq hav bhoel nail tsaol-aq, doevq nail phaqaq maq ya-ail.

Miqyail nail Yaqyov nail aqmil bhai neema thaqaq tsaol nail nul juq, nqmaq maqluv halyeel doevq nail phaqaq ya nail ngaol dai, nul juq ya heeq kivq dai, ngal nul juq bhai haoqqavq niil gevq bhoel-ai leevq-a nail ngaol.



Yaolhaq 14; 2 Gaolliqthu 5; Phaodaiq 4, 21, 22

Storyline by: Edward D. Hughes

Illustrated by: Lazarus
and Alastair Paterson

Adapted by: Sarah S.

Akeu Bible (aeu) © 2016, Wycliffe Bible Translators,
Inc. All rights reserved.

<https://live.bible.is/bible/AEUWBT/GEN/1>

©2024 Bible for Children, Inc.

www.M1914.org

www.bibleforchildren.org

