

João 14

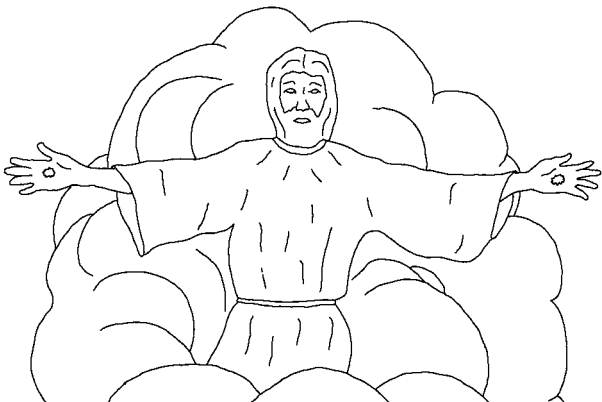

Ynara tykase roropa Jezu typoetory tomo a:
— Torêtyke pyra ehtoko jytyry poko. Emynyhmara
ehtoko. Ritonôpo enetupuhnôko matose.
Kuenetupuhtoko roropa. Tuhke osa nae Papa esao.



Arypyra ahtao morara kara exiry oya xine. Ytôko ase
oesarykô kurâkase. Imeïpo, oesarykô otyhkaxïpo
oehnôko ropa ase tarona opoko xine, ymaro
aarotohkôme kapu aka.

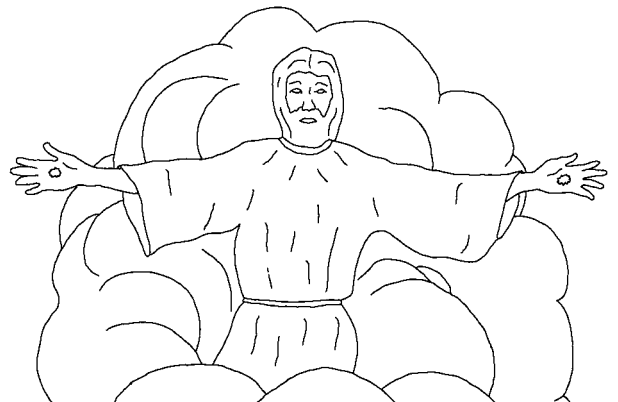

Ywy ase João, oruikomo. Jezu maro etuarimāko ase. Oetuarimarykō sã ase etuarimāko roropa. Ipoetoryme sytatose,

eanahtōko roropa sytatose.

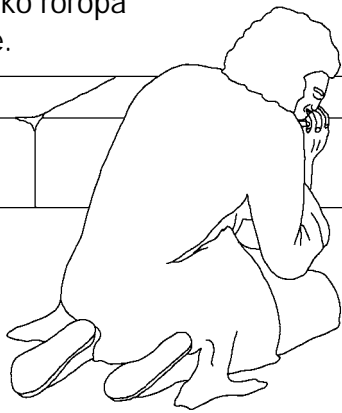

3

Ahmōta pona tonehse ywy ahno a Patimo pona, Ritonōpo omiry ekaroryke ya imehnō netaryme. Zae ehtoh Jezu namorepahpyry roropa

ekaroryke ya tonehse ywy xiaro, āpuruhyry taka samo.

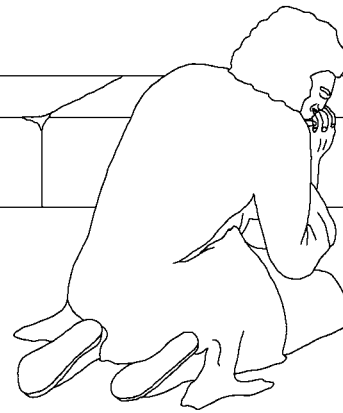

4

Mame Ritonōpo Zuzenu japoiasē. Mame osenuhmase ropa. Kapu ao tuisa apō moroto nexiase. Moro po imepỹ nexiase typorohse.

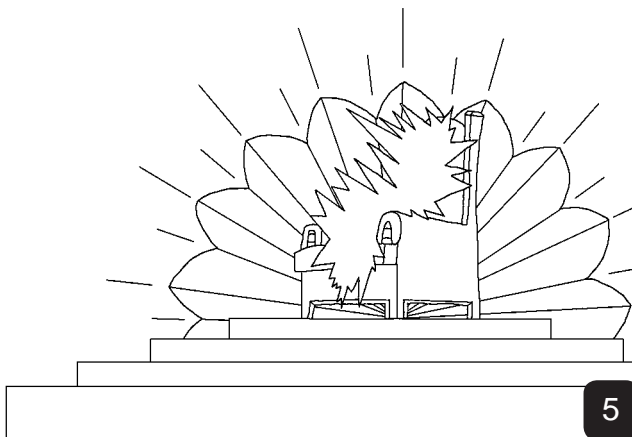

5

Moraramē kapuaōkō omiry etase emero porehme, nono pōkō omiry maro, aorihtyã ekepyry omiry maro, tuna konōto kuaōkō omiry maro. Emero Ritonōpo nyrytyã omiry etase. Eremiãko toh nexiase. Ynara nase toto tapō po iporotyhyry a, kaneru mūkuru a roropa: “Kure mase, tuisamehxo. Ritonōpo imehxo mase, orēpyrahxo mase. Jūme orihpỹme mase,” nase toto.

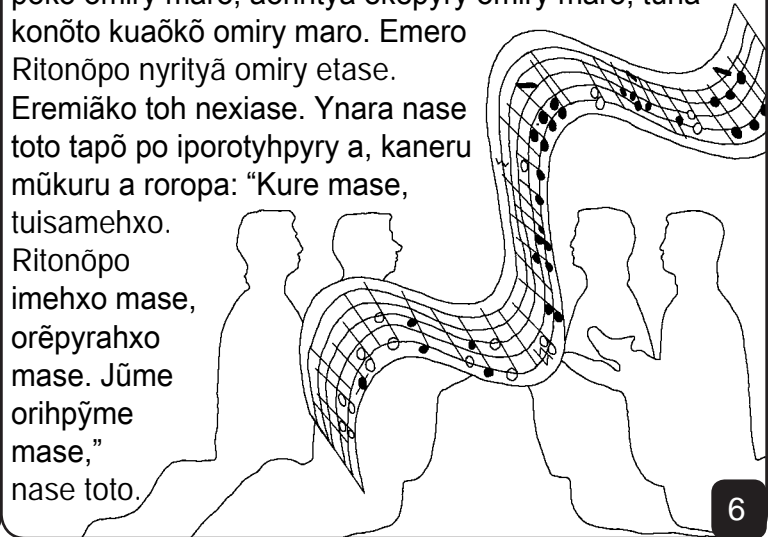

6

Mame Ritonōpo Patary Kurã eneasē, Jerusarē tyrisenano. Ayhtory eneasē kapu ae Ritonōpo poe. Tōtyhkase nexiase tosē eraximāko. Niotakety sã nexiase. Niotakety upo kurã amurūko tynio oepiry eraximatohme. Mame omi etase opore exikety, Ritonōpo apō poe:
— Seromaroro Ritonōpo esary nono pōkō maro mana. Toto maro osesarīko mana. Toto esēme exīko mana.

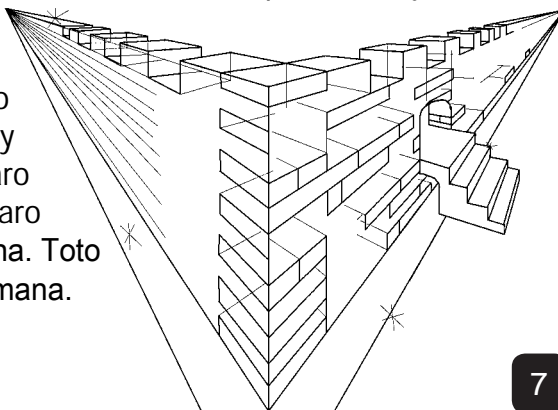

7

Moraramē Ritonōpo nenyokyhyry iporiry panō enepoasē ya, orihpyra ehtopo, zemizemikane, akusasame exikety. Moro tuna Ritonōpo apō poe tūtāko mana kaneru mūkuru apō poe.

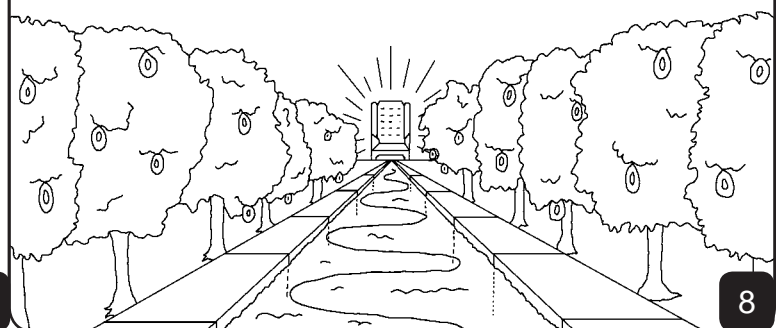

8

Xixi se pyra moro pata po, nuno se pyra roropa, saereme exiryke, Ritonōpo a tyeipose exiryke, ezurume sā kaneru mūkuru exiryke roropa.

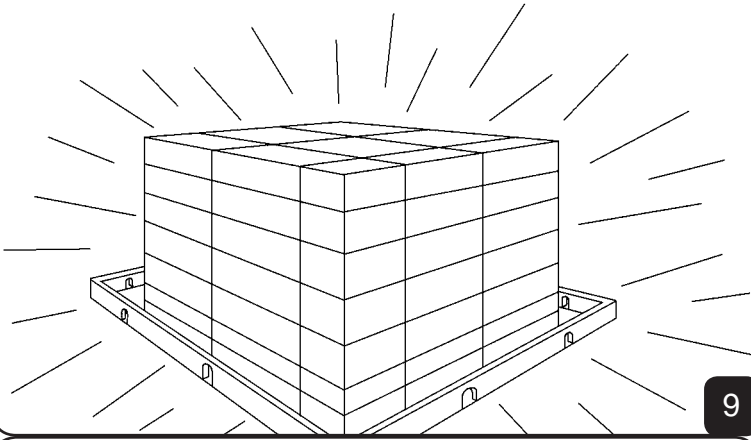

9

Yrome mā nuriame exiketō omōpyra ipunaka moro pata pona. Iirypyryme exiketō roropa, ajohpe exiketō roropa omōpyra mā toto moro pata pona. Mokaro rokē, tosetykō tymerose exiketō kaneru mūkuru papē pokona jūme Ritonōpo maro exiketō esetykō maro, mokaro rokē omōnōko mā toto moro pata pona.

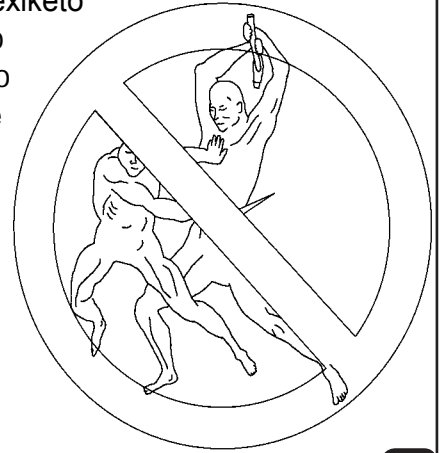

10

Toto xity korokāko mana toto enuru ae. Orihpyra ropa exīko mā toto, emynyhmara roropa. Xitakehnōko toh mana, sam kara exīko pakatokō tonahse exiryke, tykase.

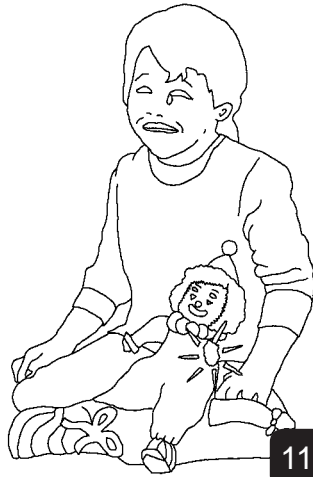

11

Pohnō pyra mā moro pata po, Ritonōpo zamaro pyra exiketō pyra mana. Ritonōpo apō moroto mana. Kaneru mūkuru apō roropa mā moro pata po. Mame: — Kure mase, āko eya ipoetory tō mana. Ēmyty enēko mā toto. Toto pery poko Ritonōpo esety tymerose mā roropa.



12

Morarame aorihtyā enease xikihme tuisa apō ēpataka tuisamehxo exiketomo, tuisamākō kara, enara. Pape tō typiapose. Imepỹ pape roropa typiapose, jūme Ritonōpo maro exiketō papeny. Aorihtyā tapiakase eya, toto nyrihpyry enexīpo emero porehme, tymerose exiryke pape pokona. Morarame mokaro esetykō pyra ahtao jūme Ritonōpo maro exiketō papē pokona mokaro emāko mā apotoimo htaka. Ikuhpo sā konōto apotoimo mana, enara.

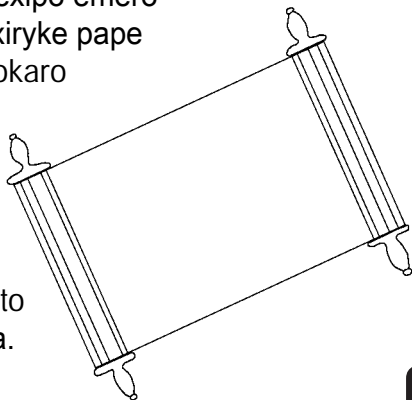

13

Kurā Zuzenu ynara āko niotakety maro: — Osehtoko! āko toto. Morara kary etaryhtao oya xine, morararo: — Osehtoko! kahtoko. Osehtoko tuna se exiketomo. Topkehke pyra ynekarory apoitoko, ōkurukōme samo jūme Ritonōpo maro oehtokōme, emero rokene.

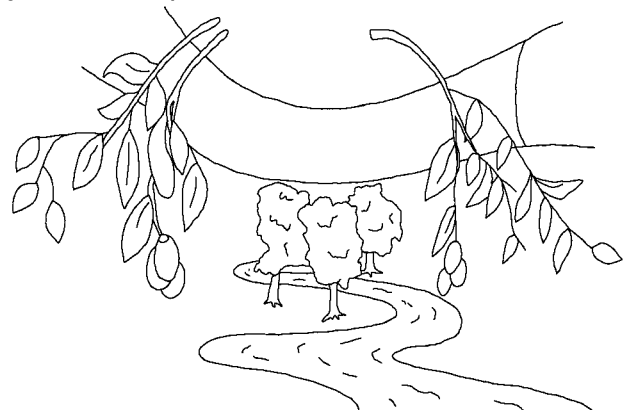

14

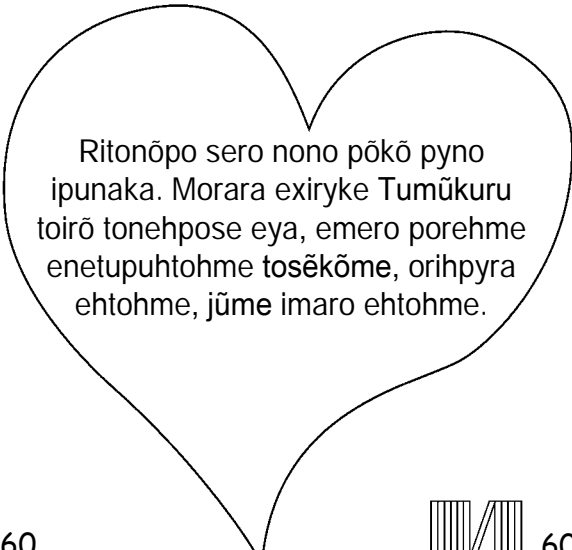

Ritonõpo sero nono pōkō pyno ipunaka. Morara exiryke Tumūkuru toirō tonehpose eya, emero porehme enetupuhtohme tosēkōme, orihpyra ehtohme, jūme imaro ehtohme.

60

60

15

Romanos 3:23 Kymarokō emero tyrypyhpyke. Osepune pyra sytatose, Ritonõpo kure exiry maro.

Romanos 6:23 Ynara exiryke, kyyrypyrykō epehpyryme orihnōko sytatose. Yrome Ritonõpo nekarohpyry ke orihpyra sytatose jūme. Jezu Kyrixtu Kuesēkō marōme exiko sytatose, toorihse exiryke kymyakākōme.

Epereu 9:27 Toipe sytatose. Emero porehme orihnōko sytatose toiro. Moromeīpo kuapiakatorỹko Ritonõpo mana.

16

Epezu 2:8,9 Naeroro tamoreme opyno xine Ritonõpo toexiryke typynanohse matose. Okurākatorỹko roropa mana kure oexirykō pokoino pyra. Jezu enetuputyryke rokē oya xine okurākatorỹko mana. Topehke pyra, tynekarory kurā sã, Tumūkuru tonehpose aorihthohme, okurākatohkōme. Naeroro epyrypasaromepyra matose Ritonõpo poenōme oexirykō poko. Kure oexirykō pokoino pyra tukurākase matose Ritonõpo a.

Romanos 10:9,10 Jezu orihxīpo tōsemākapose ropa Ritonõpo a. Moro enetuputyryhtao oya xine imehnō zurūko matose: “Jezu Jesēme mana,” āko matose imehnomo a. Morara awahtao xine opynanohtorỹko Ritonõpo mana. Ynara exiryke, kukurohtao xine enetuputyryhtao kyya xine kukurākatorỹko Ritonõpo mana. “Zae mase ya,” āko mana kyya xine. “Jezu Jesēme mana,” karyhtao kyya xine kypynanohtorỹko Ritonõpo mana.

17

João 3:16,17 Ritonõpo sero nono pōkō pyno ipunaka. Morara exiryke Tumūkuru toirō tonehpose eya, emero porehme enetupuhtohme tosēkōme, orihpyra ehtohme, jūme imaro ehtohme. Sero pōkō pynanohse Tumūkuru tonehpose Ritonõpo a, toto onuānohpyra aehtohme.

1 João 5:11-13 Ynara Ritonõpo nekarohpyry sero. Orihpyra kyritorỹko Ritonõpo mana Tumūkuru enetuputyryke kyya xine. Ritonõpo mūkuru maro exiketō orihpyra mā toto. Yrome Ritonõpo mūkuru maro pyra exiketō orihketōme toto. Onenerykōme pape merōko ase orihpỹme oehtohkō waro oehtohkōme, Jezu Ritonõpo mūkuru enetuputyryke oya xine.

18

João 14; 2 Korĩtiu 5; Apokaripxi 4, 21, 22

Storyline by: Edward D. Hughes

Illustrated by: Lazarus
and Alastair Paterson

Adapted by: Sarah S.

Apalaí Bible (apy) ©2017, Wycliffe Bible
Translators, Inc.

<https://live.bible.is/bible/ENAPBT/JUD/1>

19