

www.BibleForChildren.org

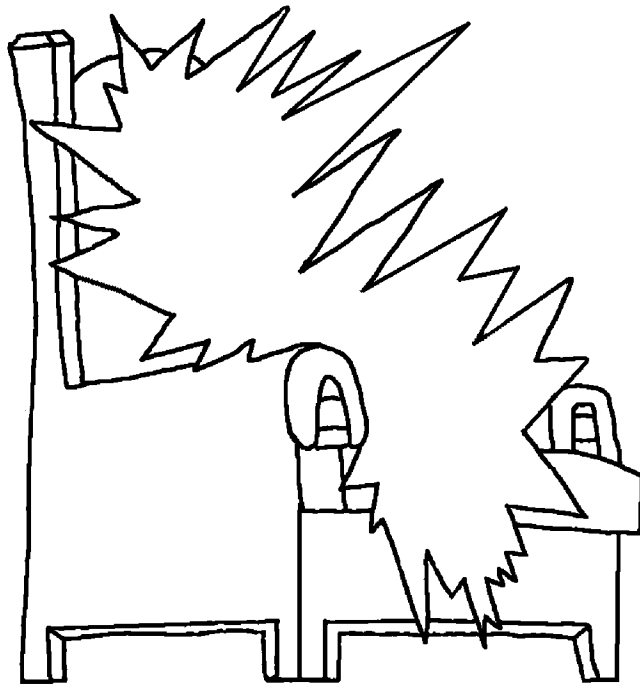

Jon 14



La cihu namen abami. Namilan hiji cuvilin cuvilin
lamimilan uami. Asi san hiji vidividin lamalama iasan
avi hiji vidividin lamihalan uami. Iadi lavan di ulan agan
nibu uv akape uami. Hamen sadan via nalusan ulan
uv hihila hihila san uben uami.



Ulaŋ uvi akuaba akuaba hamenŋ agilaŋ apali lici viaŋ
naludi ma abavin uami. Viaŋ uavila ulaŋ uvi haiabila
akuaba akuaba agiladi sihuviben uami. Sihuvavila cihu
ve naludi via uavila alaŋ ahuata hinibalu uami. Haiabila
viaŋ hiniben heŋ namilaŋ avi viaŋ hula hinibalaŋ uami.



Viaŋ Jon uami. Viaŋ naludɪ isaima me hinilan uami.
Namilaŋ Jisasi saŋ hiji vidividiŋ lamilalaŋ hamen
ala viaŋ avi nusaŋ hiji vidividiŋ lamilan

uami. Lidamili nibu aludɪ
likilidaci nudɪ lihu hivi



pam hinilalu uami.
Hinihini viaŋ namilaŋ

hula avitha avitha iga
iga vihili havahava
vidividiŋ lagulamilan
uami.



Lidinġ Asi di cian agadi sulasula hidacin uami. Cian
Jisasi abami agadi avi sulasula hidacin uami.
Hamenġ lidalinġ nibilanġ iadi lahuavici

uavila Patimosi avili
muha heġ hinilan uami.



Lici Asi di Aminj aganj viaj hula hinidaci viaj Asi di
haiabila hej igaihua igilij Asi aganj nudi nukenj
migahinihini hisinj uvi hej migahini uami.



Lihavici cihu akuaba akuaba Asi lamami agiladi ulin
ulin abin abin avi igahilin uami. Akuaba akuaba fili
nen hiniavilali agilan uami. Akuaba
akuaba Asi di haiabila hisin agilan
uami. Akuaba akuaba fili muji
hisin agilan uami. Akuaba
akuaba avili hekili hisin agilan
uami. Nibilan
sikasikan
abeba abeba
hiniavilali
agilan namen
abavi uami.

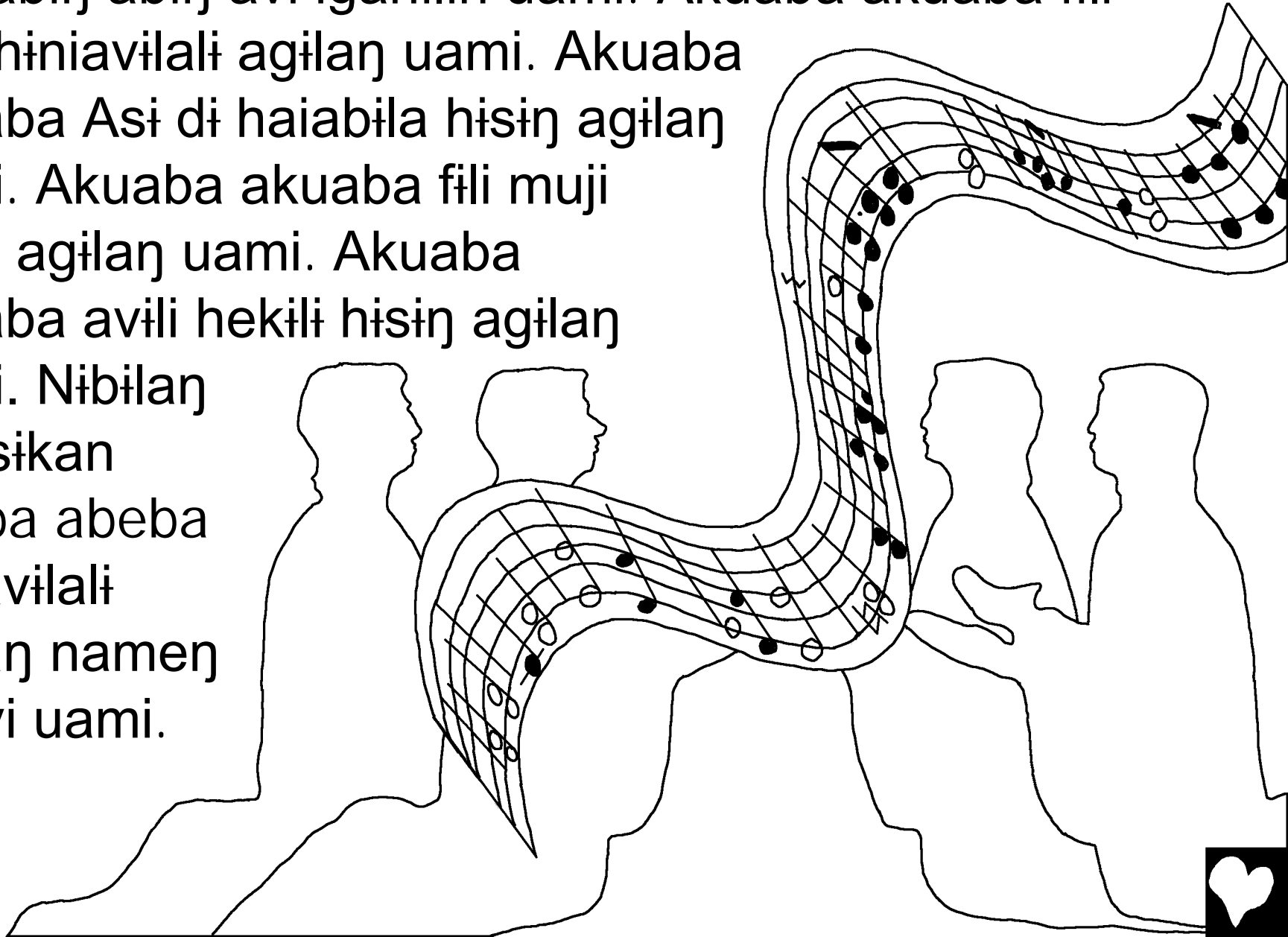

Asi nudi migahinihini hisin uvi hivi migahinihini saban
sipsipi ninañ agañ hula ibi hekili dan hiniavadi aba
abavi uami. Nibilañ vidividiñ hekili
dan hinihini akuaba akuaba agiladi
hamen laci hamen laci migilavibali
aba abavi uami. Hulañ iamigali
sikasikan nulisañ hijinalanala nulidi
ibi miñaiahaiaha
abavibali aba
abavi uami.
Namilañ huaci
sibanñ aba
abavibali aba
abavi uami.

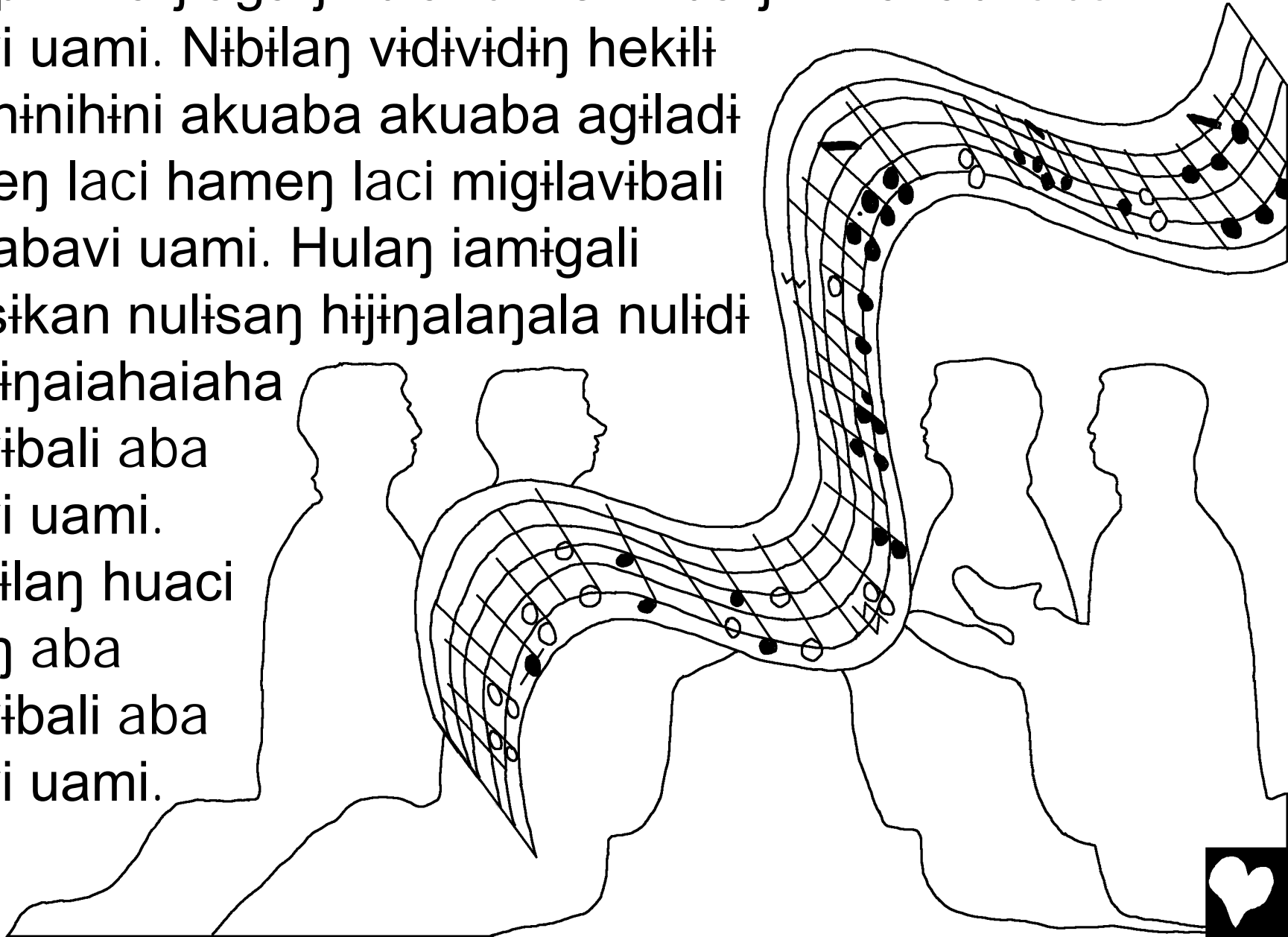

Lici Asi di haiabila sebiti huaci sibanj agadi igin uami.
Haiabila agadi ibi Jerusalem uami. Nibu Asi iahua hivi
hinilali henj hinya migi uami. lamigali munanj iahuben
aba hajinj huaci huaci agiladi lamavila hiniavilali hamen
agiladi nudi hivi hajinj lamici migi

uami. Lici
igahilidaliq Asi
di migahinihini
hisiq uvi henj cian
namenj vidividiq
abi uami.

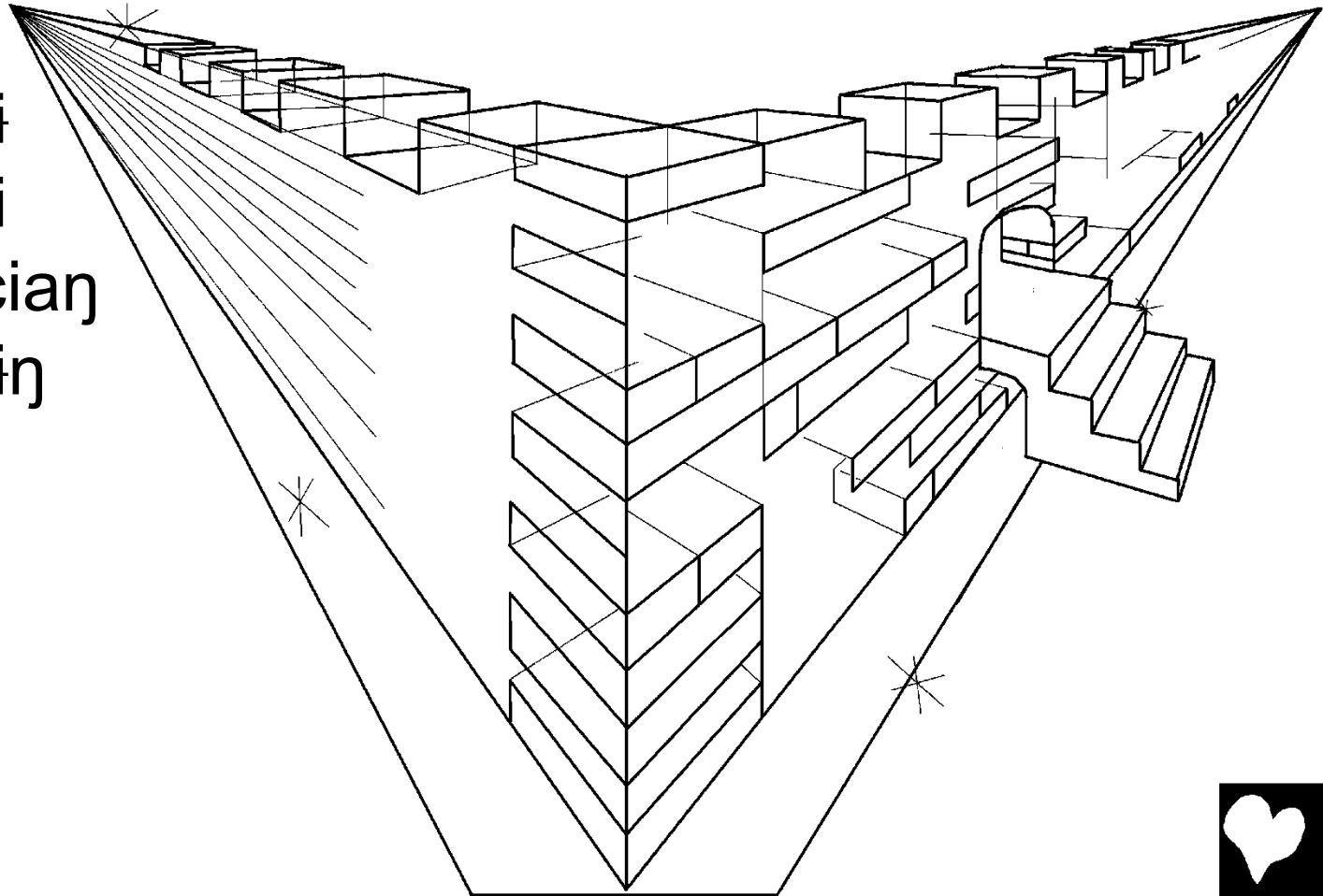

Ci iginan̄ aba abi uami. Asi di havili ulan̄ agan̄ hulan̄
iamigali agilan̄ hula hinibali aba abi uami. Hinidaci hulan̄
iamigali agilan̄ Asi di nuken̄ hulan̄ iamigali hiniavibali
aba abi uami. Asi nuken̄ avi nibilan̄ hula hinibali aba
abi uami.

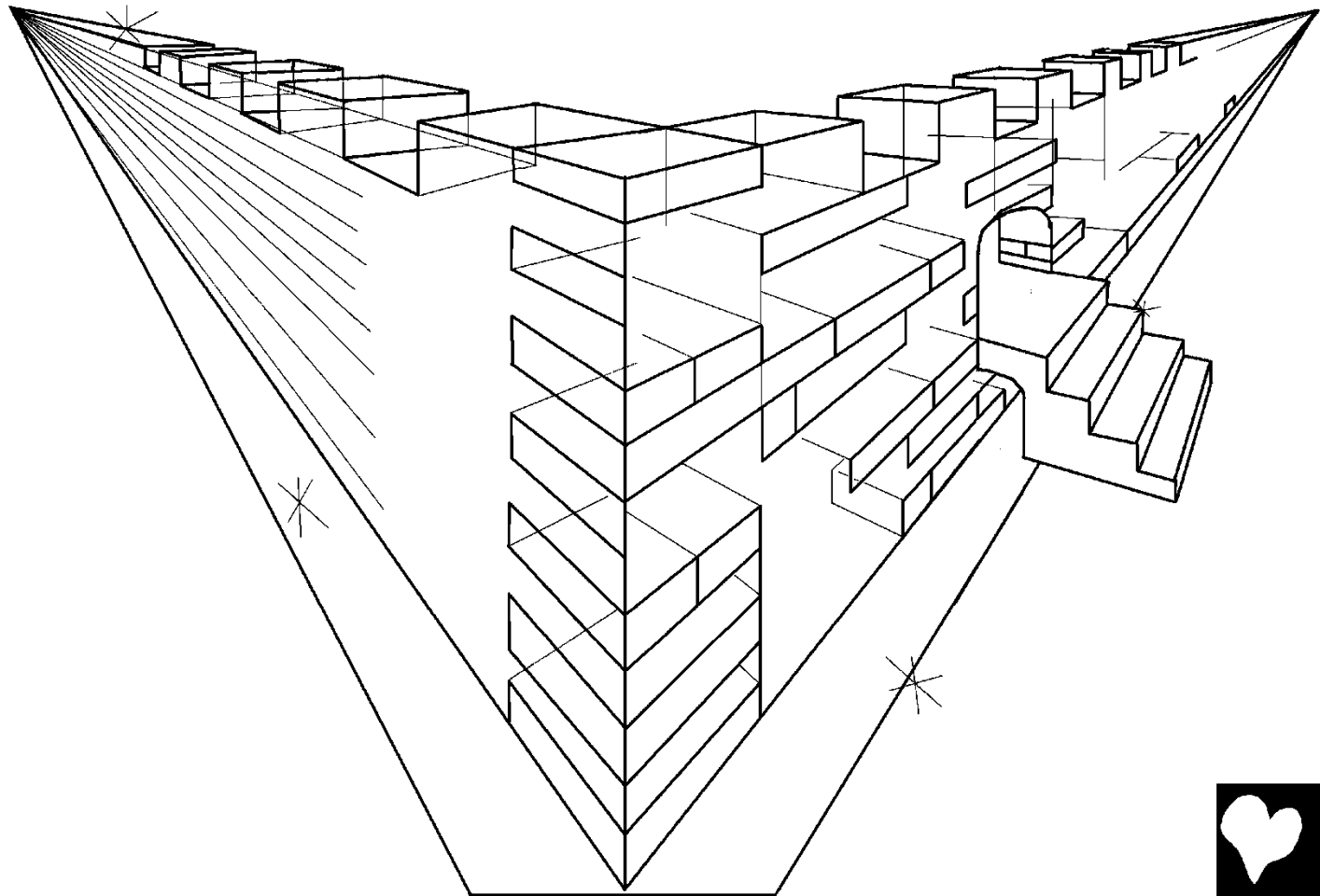

Asi di cian hali hisin agan huaci hamej laci hamej laci
hinihini hisin avili agadi iadi abalami uami. Lici igilin avili
minam minam agan minapala minapali uami. Avili agadi
hidili agan migahinihini hisin uvi Asi hula saban sipsipi
ninan hula migahiniavilali agadi lihu hen hini uami.
Hinihini haiabila agadi hibi pili alihan siban hen ve uami.
Avili agadi limu caba limu caba hen huaci hamej laci
hamej laci hinihini hisin kili agilan

hiniavi uami.

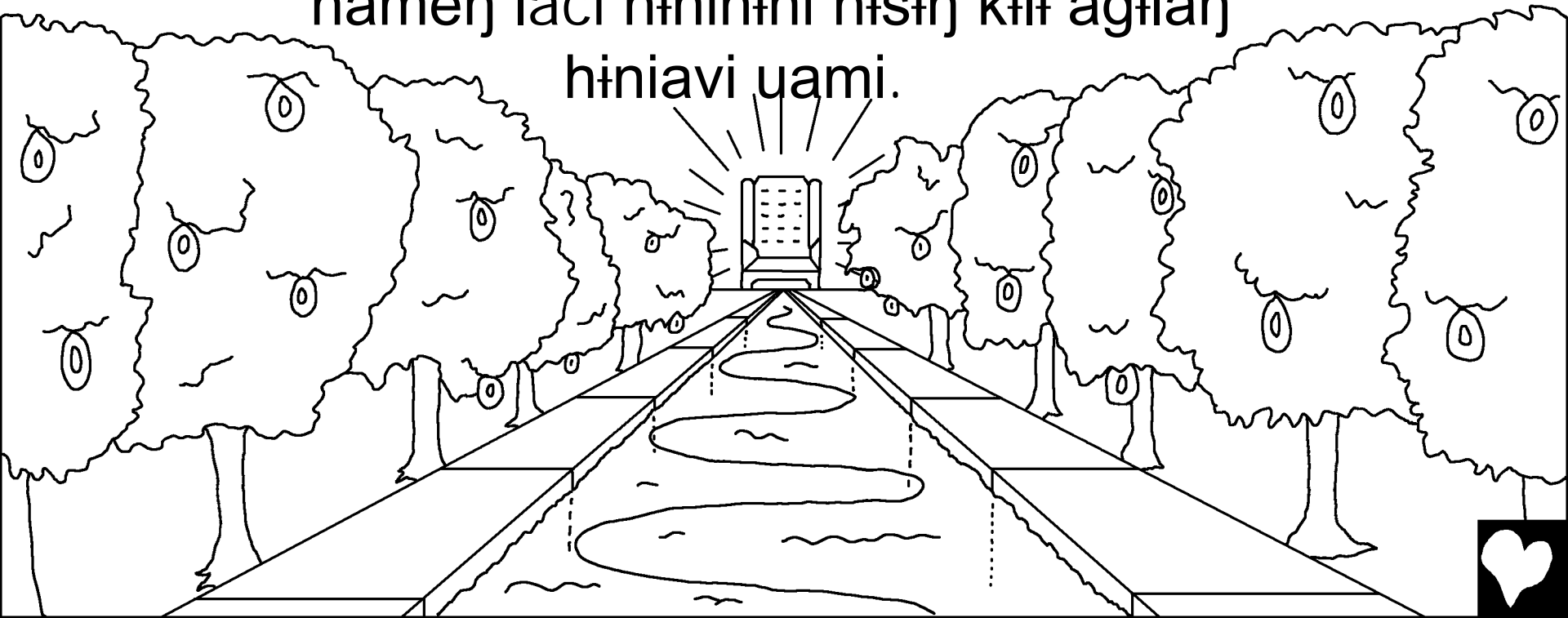

Haiabila agadi abilu igu igu hisin uaian apali uami.
Avaŋ avi apali uami. Asi di abilu hekili vidividiŋ dan
agaŋ haiabila heŋ abilu havalilali uami. Saban sipsipi
ninaŋ agaŋ haiabila agadi uni me hinilali uami.



Agadi ala akuaba akuaba Asi igidaci sibili siban
hiniavilali agilan uami. Hulan lusin sibili
sibili mu hidili mu hidili
vihavilali agilan uami.
Hulan anali cian
abavilali agilan uami.
Nibilan haiabila hen
ma ivouavibali uami.
Hulan iamigali nulidi
ibi saban sipsipi ninan
agadi manasin huaci
hamen laci hamen laci
hinihini hisinagadi hivi
hiniavi agilan pam haiabila
hen ivouavibali uami.



La hulan iamigali sikasikan agiladi ilihin avili cibi
ifihusibali aba abi uami. Lici cihu cihu ma himavibali
aba abi uami. Cihu cihu mavin mihamija ma ilihavibali
aba abi uami. Ilihin cihu cihu ma
ilihavibali aba abi uami. Aviha
aviha avi cihu cihu ma igavibali
aba abi uami. Akuaba akuaba
vaka hisin agilan sikasikan
sivilavila apali lihavibali
aba abi uami.



Asi igici akuaba akuaba sibili lihavi agilan sikasikan
haba sivilavibali uami. Migahinihini hisin uvi Asi hula
saban sipsipi ninan hula migahiniavilali agan haiabila
hen hinibali uami. Hinidaci

Asi di sibila hisin hulan
agilan hen hinihini
nudi sibila vihavibali
uami. Sibila vivi nudi
mugan lamigan
igavibali uami.

Lihavidaci nudi
ibi agan nulidi
libam hivi
hiniavibali uami.



Lavila igidalin hulan iamigali ibi dan hinihini himavali
agilan nudi migahinihini hisin uvi agadi mavin lama
hinihini hen lagulama hiniavi uami. Hulan iamigali
ibi apali hinihini himavali agilan avi hen ala
lagulama hiniavi uami. Lihavidaci Asi di
cian hali hisin agilan manasin agiladi
mihalavilavi uami. Hulan iamigali
akuaba akuaba lihavilali
agiladi cian manasin
agiladi hivi hiniavi
uami.

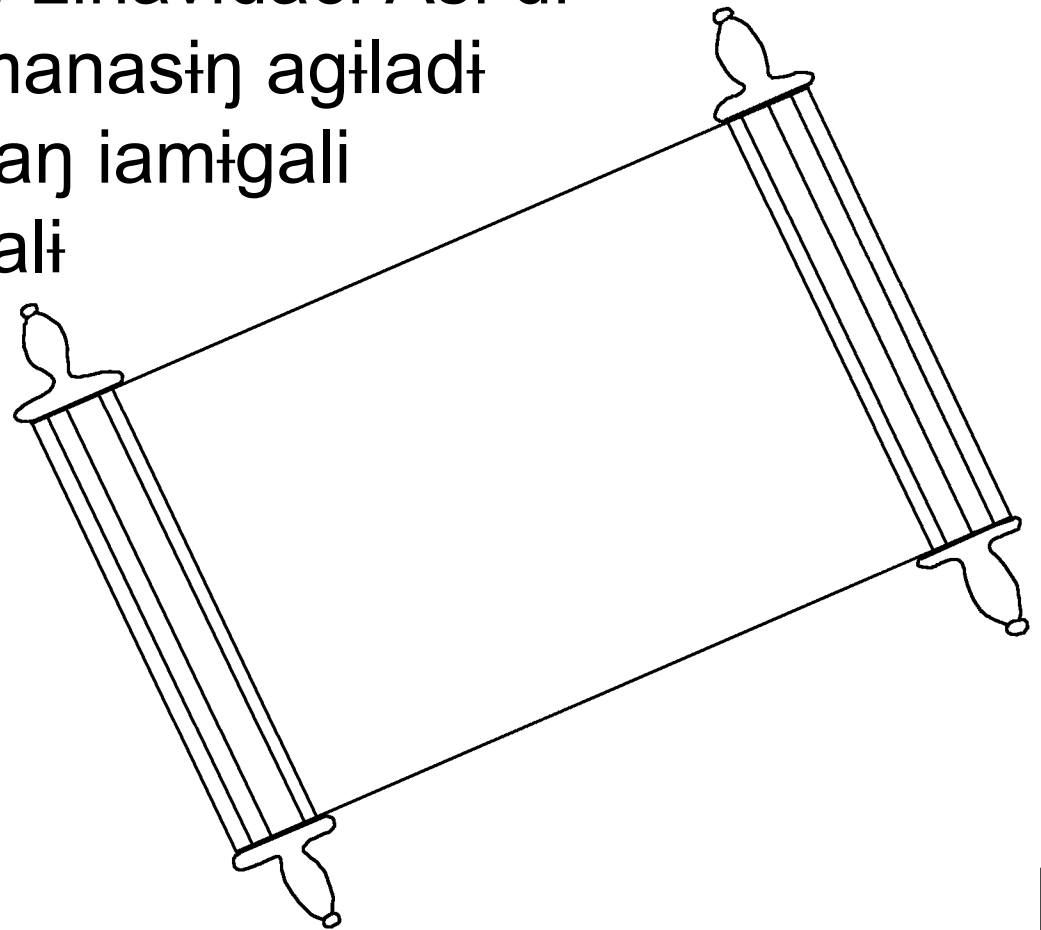

La huaci hamen laci hamen laci hinihini
hisiŋ manasiŋ agadi avi miŋalavilavi uami.
Lihavici Asi agan manasiŋ agiladi
iga iga hulan iamigali himavali agiladi
hitiŋ hitiŋ cian hivi lami uami.
Hulan iamigali nulidi ibi huaci
hamen laci hamen laci
hinihini hisiŋ manasiŋ
hivi ma hiniavi agiladi
avi aviŋ lihulihu
hinilali hen havalici
miguavi uami.

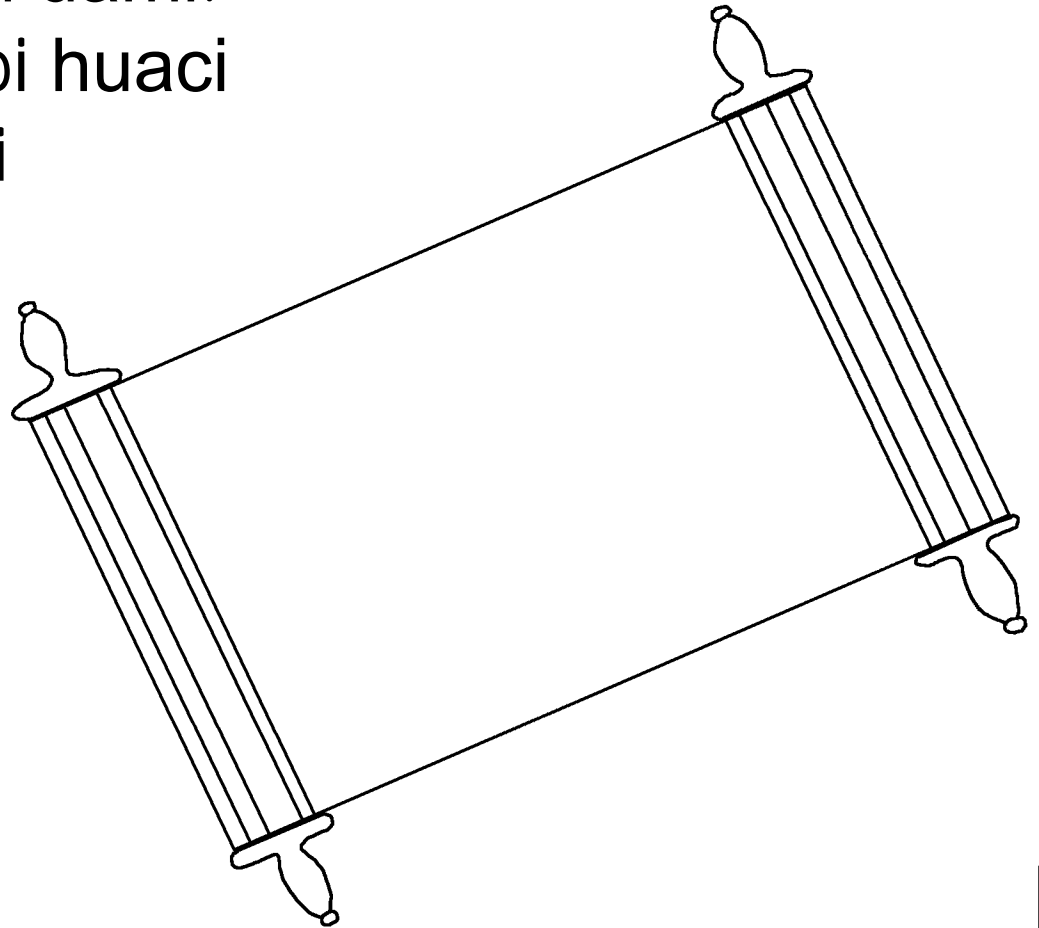

Lici Asi di Aminḡ aganḡ hula iamḡgali sabanḡ
sipsiptḡ ninanḡ sabibali aganḡ hula Jisasi di namenḡ abavi
uami. Nama vaha aba abavi uami. Hulanḡ iamḡgali cianḡ
nagadi igahilavilali agiladi avi abavi uami. Namilanḡ avi
abihalanḡ aba abavi uami. Nama vaha aba abihalanḡ
aba abavi
uami.



Lavila abavi uami. Hulan avili nana san lavila nudi pin
vehavim aba abavi uami. Hulan avili nana san mavin
hiniavilali agilan avi huaci hamej laci hamej laci
hinihini hisin avili agadi vihavim aba abavi uami.
Akuaba akuaba agiladi anim hilici hivi ma lavavibali
aba abavi
uami.



Asi di Ninan
pabin ciki siban
uami. Agadi ala Asi
agan hulan iamigali fili hiniavilali agilasan
mavin hekili hiniavila abici migami uami.
Hulan iamigali agilan nusan hiji vidividi
lamalama ma sibili lihavibali aba nudi
abici migami uami. Huaci hamen
laci hamen laci hiniavibali
aba abici migami
uami.



Lom 3:23

Hiniavidaci nibu Isilaeli hidili agiladidan hidili mu mu agiladidan namen abilali uami. Namilan sikasikan lusiñ sibili vilalan sadan iadi haiabila ma ubalan aba abilali uami.

Lom 6:23

Namilan lusiñ sibili viavila ha akuaba akuaba huaci huaci ma vibanan uami. Lusiñ sibili agilan lihavidaci namilan himidalan naludi amin agilan Asi hula huaci hamen laci hamen laci ma hiniavibali uami. Agadi ala Asi agan nudi akuaba akuaba huaci huaci agiladi alusan havi siban igudaci vilalu uami. Hamen sadan mufili alan huaci hamen laci hamen laci hinibalu uami. Aludi Hekili Jisasi Kilaisi agan laci nudi vidividiñ hivi akuaba akuaba huaci huaci agiladi vibalalu uami.



Ibilu 9:27

Hulan jamigali sikasikan agilan pabin tibi siban himavici
Asi nulidi cian hivi lamibali uami.

Efesusi 2:8,9

Namilan Jisasi Kilaisi san hiji vidividiŋ lamilalan sadan Asi
agan nalusan mavin hinihini naludi ahiliahudaci huaci
hamen laci hamen laci hinibalan uami. Akuaba akuaba
hamen agiladi namilan nuken ma lilalan uami. Asi agan
akuaba akuaba sibila vilalan agasan ma igahililali uami.
Nibu naludi havi siban ahiliahulali uami. Hamen sadan
namilan naludi nuken ibi ma miŋaiahibalan uami.

Lom 10:9,10

Namilan haiabila iahaiaha namen abilalan uami. Jisasi
nibu iadi Hekili aba abilalan uami. Lidin Asi agan Jisasi
Kilaisi di abici cihu hihi iahami agasan hiji vidividiŋ
lamilalan uami.



Hamenj lidalanj Asi aganj naludj ahiliahudaci huaci hamen
laci hamen laci hinibalanj uami. Alanj aludj nukenj hiji
humiganj hivi Asi sanj hiji vidividiŋ lamidamili Asi aganj aludj
namenj abibali uami. Namilanj hulanj iamigali huaci aba
abibali uami. Lidaci aludj hiji vidividiŋ agilasanj aludj sibisanj
hivi haiabila iahaiaha abidamili Asi aganj aludj ahiliahudaci
huaci hamen laci hamen laci hinibalu uami.

Jon 3:16,17

Asi di Ninanj pabinj ciki sibanj uami. Agadi ala Asi aganj
hulanj iamigali fili hiniavilali agilasanj mavin hekili hiniavila
abici migami uami. Hulanj iamigali agilanj nusanj hiji
vidividiŋ lamalama ma sibili lihavibali aba nudj abici
migami uami. Huaci hamen laci hamen laci hiniavibali aba
abici migami uami. Asi aganj nudj Ninanj agadi abici fili nenj
migami ha hulanj iamigali agiladi libimigumigu aba aba
sanj ma abici migami uami.



Nibu hulanj iamigali agiladi ahiliahudaci huaci hamenj laci
hamenj laci hinihini sanj abici migami uami.

1 Jon 5:11-13

Asi aganj aludi namenj abilali uami. Vianj iadi Ninanj agadi
abilinj miguavila naludi ahiliahuci namilanj huaci hamenj laci
hamenj laci ci hinidalanj aba abilali uami. Hamenj sadanj
alanj hiji namenj lamilalu uami. Asi nibu aminj abilali aba
abilalu uami. Hulanj mu Asi di Ninanj aganj hula hiji pam
hinilali aganj nibu huaci hamenj laci hamenj laci hinilali uami.
Hulanj Asi di Ninanj aganj hula hiji pam ma hinilali aganj nibu
huaci hamenj laci hamenj laci ma hinilali uami.

Vianj hulanj iamigali Asi di Ninanj agasanj hiji vidividing
lamilalanj nalusanj cianj nagadi libadin uami. Hiji namenj
igahilibalanj aba libadin uami. Alanj huaci hamenj laci
hamenj laci ci hinidalu aba abibalanj aba libadin uami.



Jon 14; 2 Kolin 5;
Cianṅ haiabila lama abami. 4, 21, 22

Storyline by: Edward D. Hughes

Illustrated by: Lazarus
and Alastair Paterson

Adapted by: Sarah S.

Apali Bible (ena) © 2022 Pioneer Bible Translators

<https://www.bible.com/bible/3351/GEN.1.APALGENT>

©2026 Bible for Children, Inc.

www.M1914.org

www.bibleforchildren.org

