

www.BibleForChildren.org



Jowa 14



Eejatzi ikanteeyanakinani Jesoshi: —Eero pikenkithashiryaashipiintawo inta pameentyaari Tajorentsi. Eejatzi naari, pameentena. Janta inampiki Pawa eenitatsi oshekini pankotsipaeni. Eero oshekitzimi, ari nokantemimi: "Tee oshekitzi".



Niyaate janta niwetsikaeyapaemini pipanko,
pijeekanteeyapaeyaarini eeroka iinja.
Aririka nomatemi ro pi jeekantyaari, ari napiitaatero
nopyashiiyakitemini nagaeyaatemini. Aritaki
notsipatapaakimi no jeekinta naari.

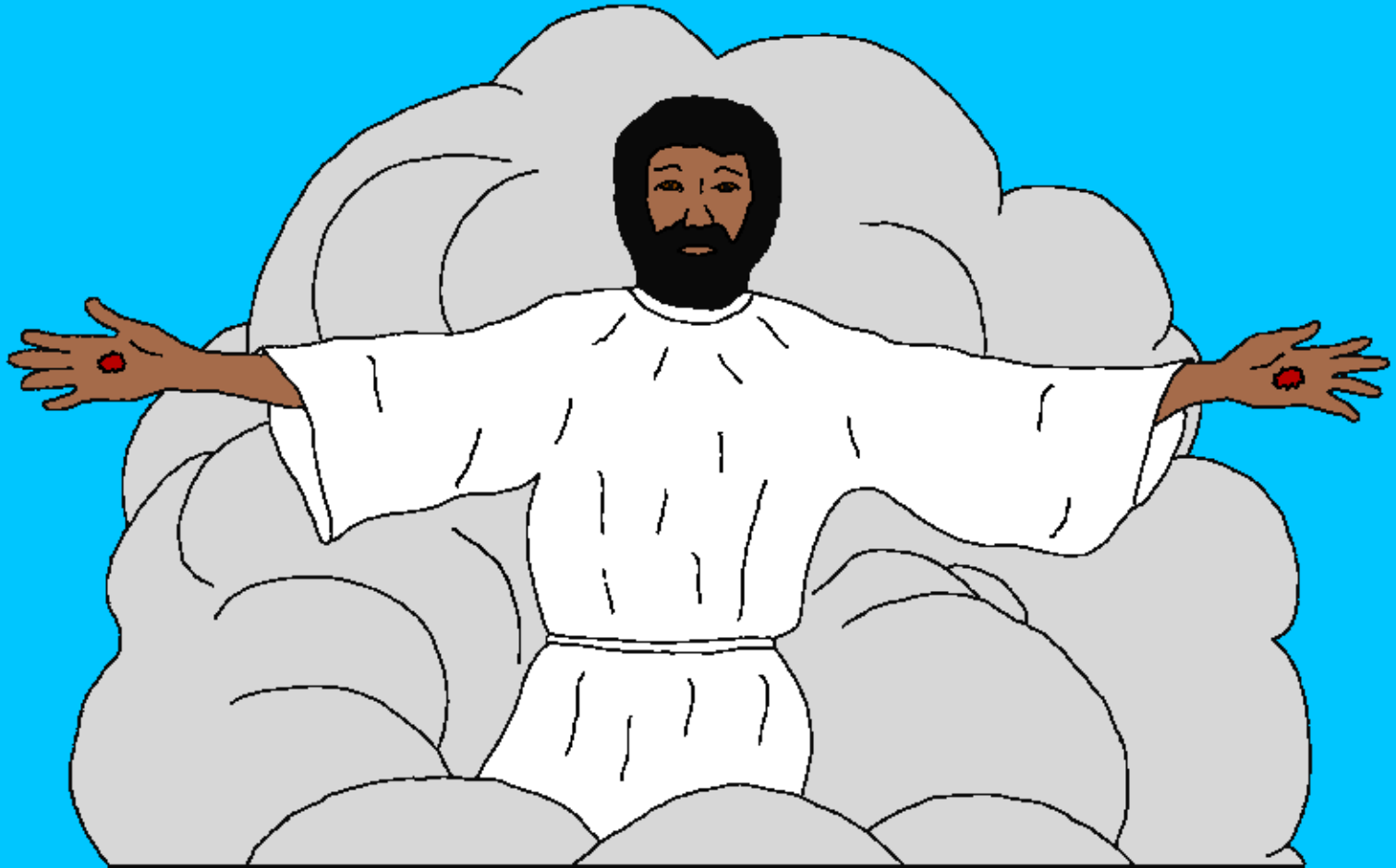

Ari, noyemijantzinkarite, akimitawakagaeyakani:
aapatziyeeyakarini Jesoshi, rootaki
rowashironkaapiinteeyantakaeri

theenkantatsiri. Ipinkathariwenteeyakaeni
Jesoshi, rootaki



amateeyantakaworini
eshiwentakiro
akemaatsitawentyaari
irira.



Nokenkithatziro iñaani Tajorentsi, tema
nokenkithatakotakiri Jesoshi, rootaki
rookanteetakinari jaka othampishiki

iiteetziri Paatzimoshi.



Rootaki omatakaakinawo Ishire niyaatantakari
jenokinta. Janta noñaapaakiri ishipakiryaaaki
ikimitakawo mapi iporeryaataki kityonkari eejatzi
natsiryaaathari. Niyotantakariri riro Tajorentsi.
Iyotaakina Ishire.

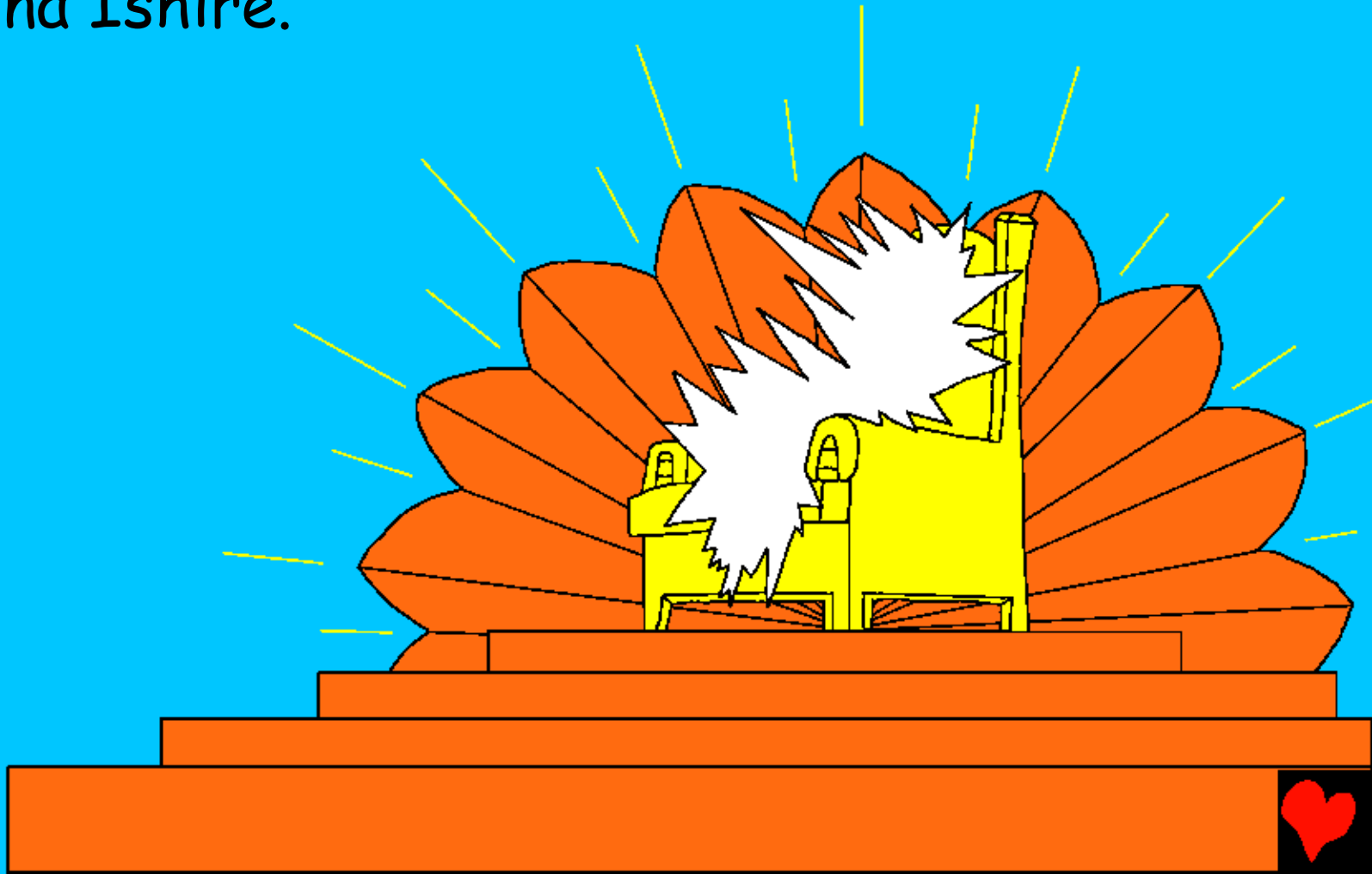

Eejatzi noñaakiri ijeekaki iwinkatharimentoki. Ari
rinkinagaakitakiro kimitaka oye inta apaani ikanta
natsiryathari. Ari ikanta ishipakiri. Omaanta
Tajorentsi osheki ishipakiri, morek, morek, tharek,
tharek, morek, tharek.

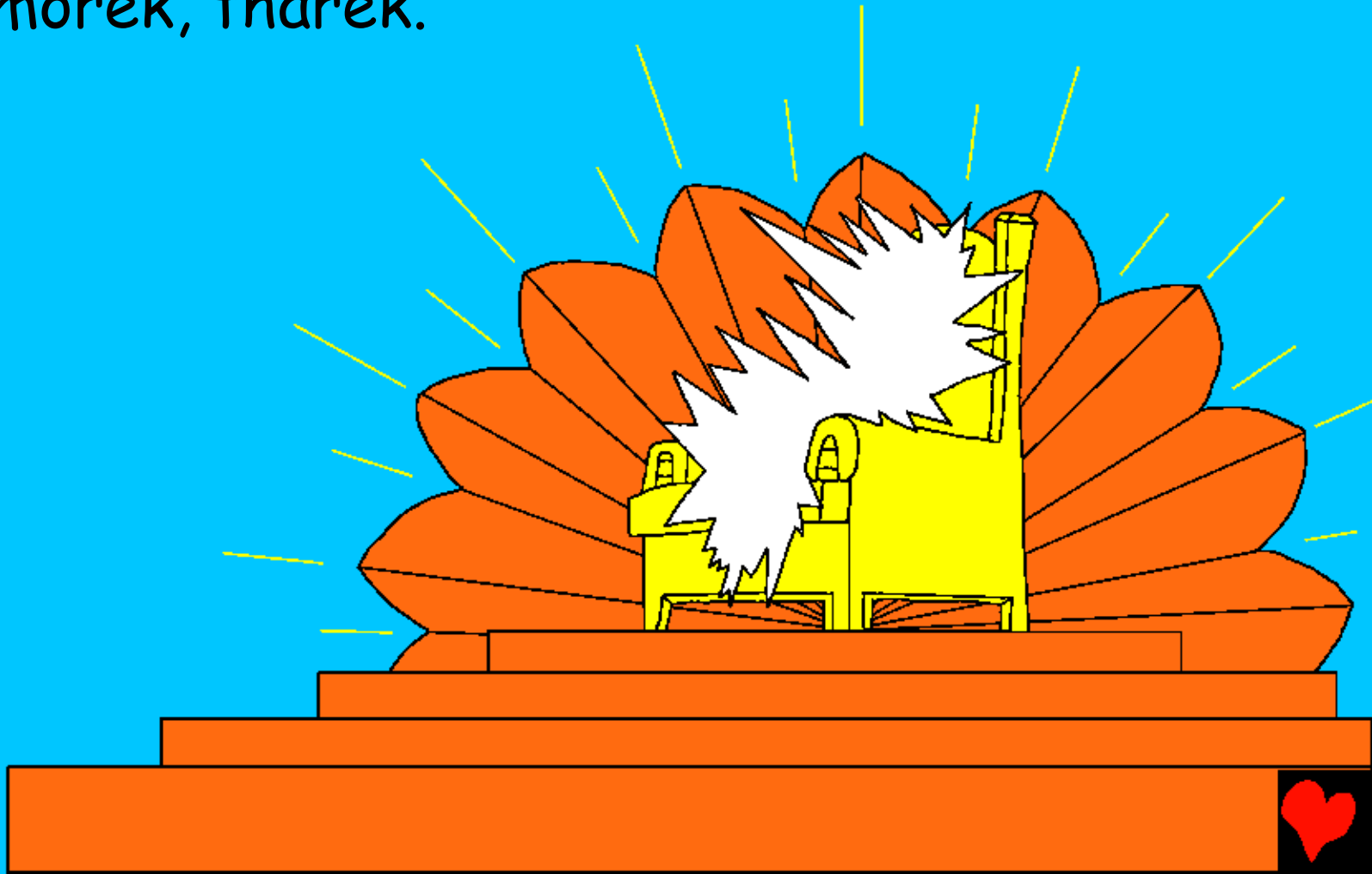

Eejatzi nokemaeyakirini maawaeni jeekatsiripaeni
jenokinta, eejatzi kipatsiki, eejatzi maawaeni
kamaeyawiteencharini: riraga
kitatawiteenchari kipatsiki,
eejatzi piinkawitachari;
romampaawenteeyakarini
maawaeni
kameetha: ...



... "Thame Maawaeni aweshiryaaawenteeyaarini
Tajorentsi jeekatsiri iwinkatharimentoki eejatzi
Rowishate, apinkathateeyerini,
añaperoyerini,
akanteetatyeeyaani.
Tema itajorentsitaperotaki,
ikanteetatyeeyaani".



Eejatzi noñaakiro rowaga Jerojaree owakirari,
rowaga kameethaperotatsiri inampi Tajorentsi;
opoñaanaka jenokinta, ayiitapaaki kipatsiki. Osheki
owaneenkayitakani, okimitakawo tsinani,
rootentsirika aye oemi, owaneenkataka.

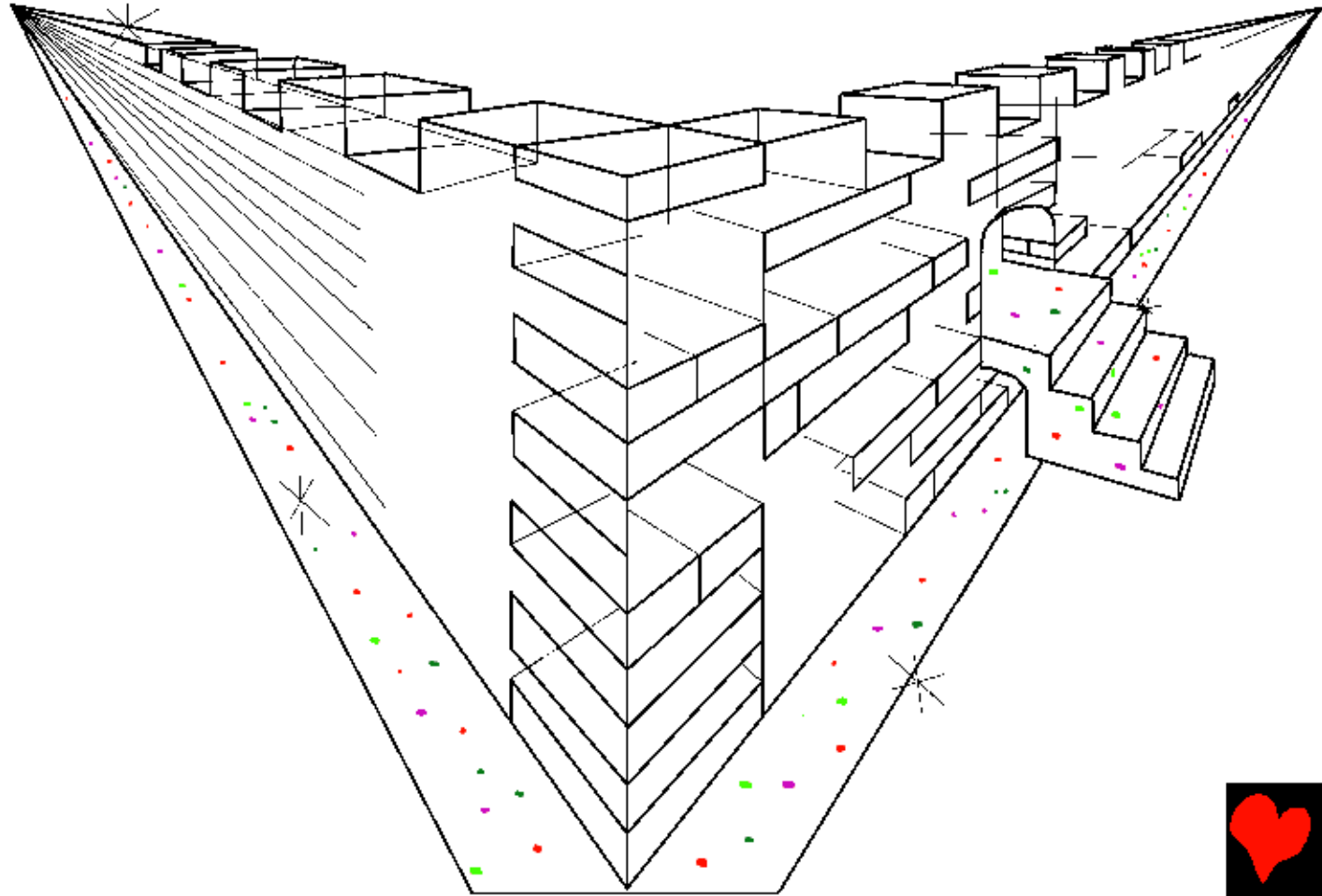

Nokemakiri jenokijatzi, jeekatsiri
okaakini iwinkatharimentoki Tajorentsi.
Itacheronkawaantetzi, ikantzi: —Pamineeyeni:
riyaataki Tajorentsi jaawiki ijeekimoeyerini atziri.
Kijokiro rowaeyerini, isheninkaeyantyaaririni. Eero
rookaeyirini.
Riroripaeni
ipinkathateri
apatziro rirori.

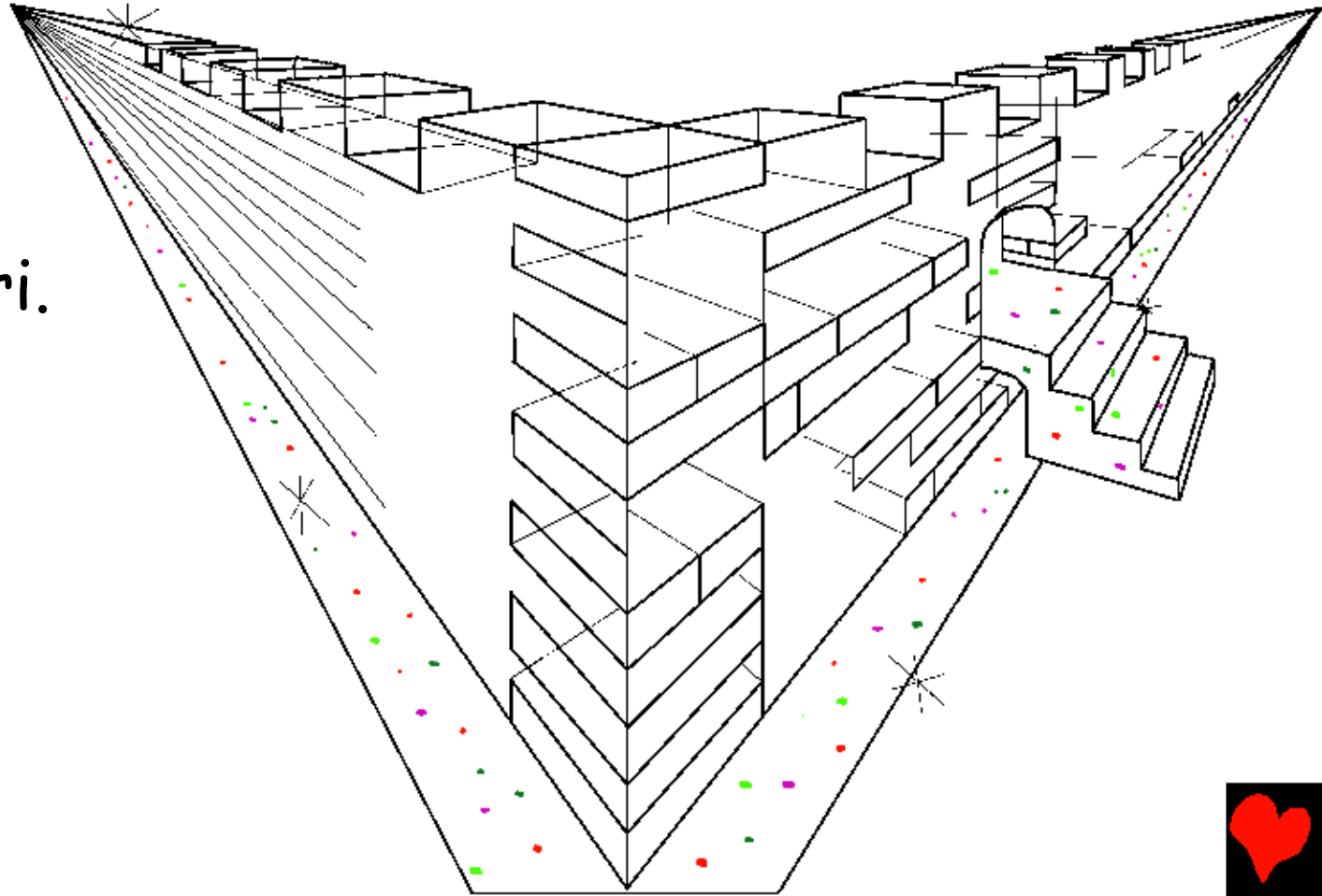

Roojatzi roñaagakinawo ronampiri Tajorentsi
antaworoña eni, jaankanaanikitatsiri, ikanteetziro:
iña owañaantatsiri. Oshiyakaawentzirori tsika
ijeekakaantee akanteetatyeeyaani. Opoñaaka
iwinkatharimentoki Tajorentsi eejatzi Rowishate,
yowaatapaaki, shaaag.

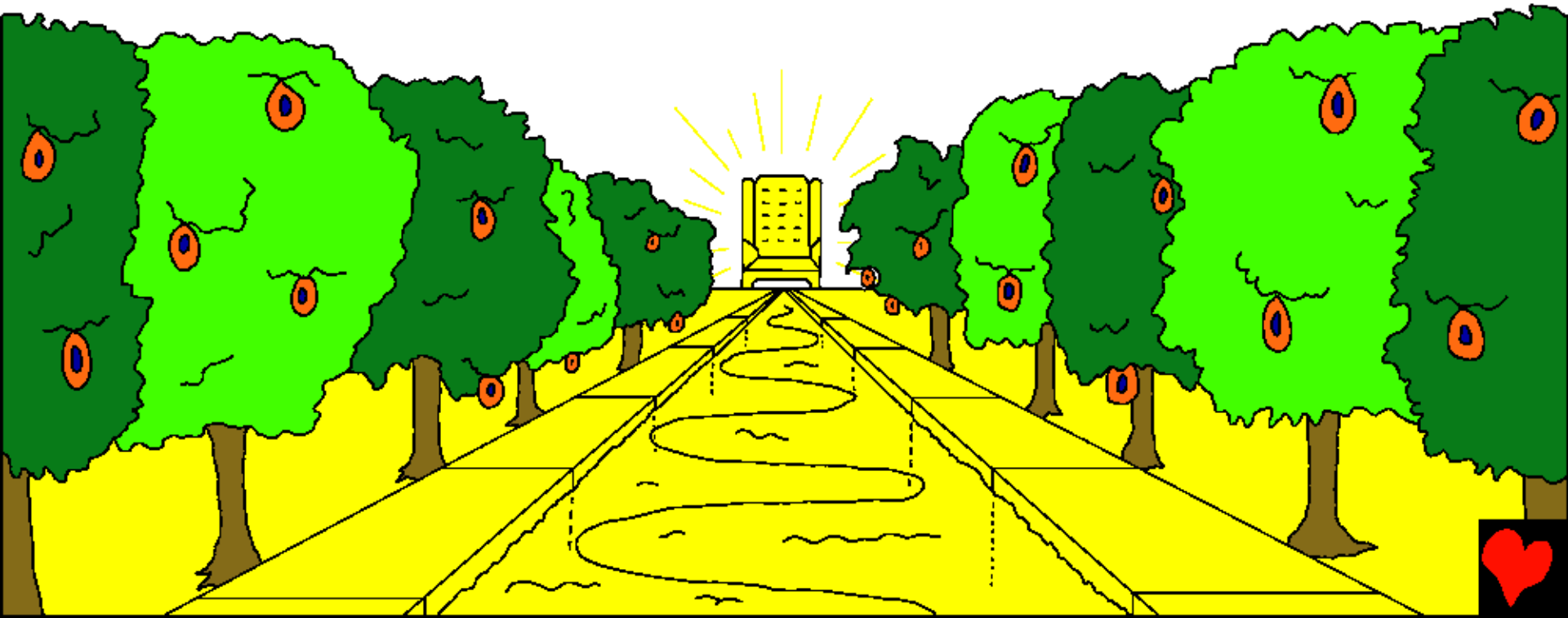

Tee ijeeki oorya roorenantyaawori nampitsi,
eejatzi tekatsi kashiri kitamashiteroni: tekatsi
ikowaeyantyaaririni. Tema ijeeki Tajorentsi, osheki
ishipakiri okitejitantari nampitsi. Eejatzi ikimita
Rowishate, roorentakoeyakaeni.

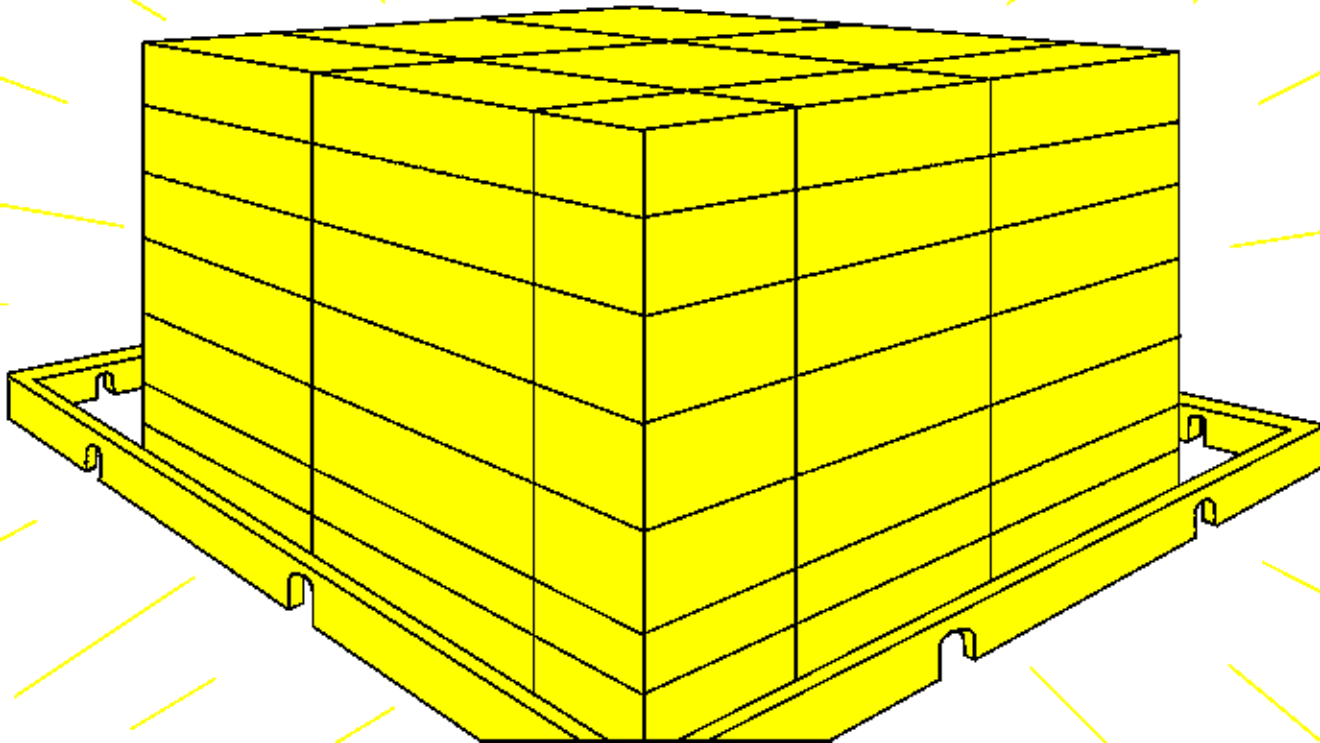

Eero okyaapae janta kaari kiteshiretayitatsirini
oetarikapaeni. Eejatzi eero rareetanta
antayitzirorini kaari
kameethatayitatsini,
tsikarika okantayitarini;
eejatzi eero rareetanta
amatawitantatsiri.



Omaantakya riraga
areeteeyachani
rirotaki
jankinatakoeyacharini
iwaeropaeni janta
iñaanamentoki rashi
Rowishate Tajorentsi.
Riroteeyakini
jeekatsini
Tajorentsiki,
ikanteetatyeeyaani.



Riweshiryakagaeyarini,
eero ishinetziri atziri
riragaeyeeyani eejatzi; eero
ikamaeyeeni. Eero riraakotaari
eejatzi kamaentsirini, eero
ishenkataa, eero
ikemaatsitaawo oetarikapaeni.
Aritaki othonkyaari maawaeni
irokapaeni. Tekatsi.



Eero añiïro janta nampitsiki kaari iñaaperotziri
Tajorentsi kameethatayitatsini; tema janta ijeeki
rirori eejatzi Rowishate. Ipinkatheeyerini maawaeni
atziri janta, tema riroteeyakini aapatziyeeyaririni
Jesoshi.

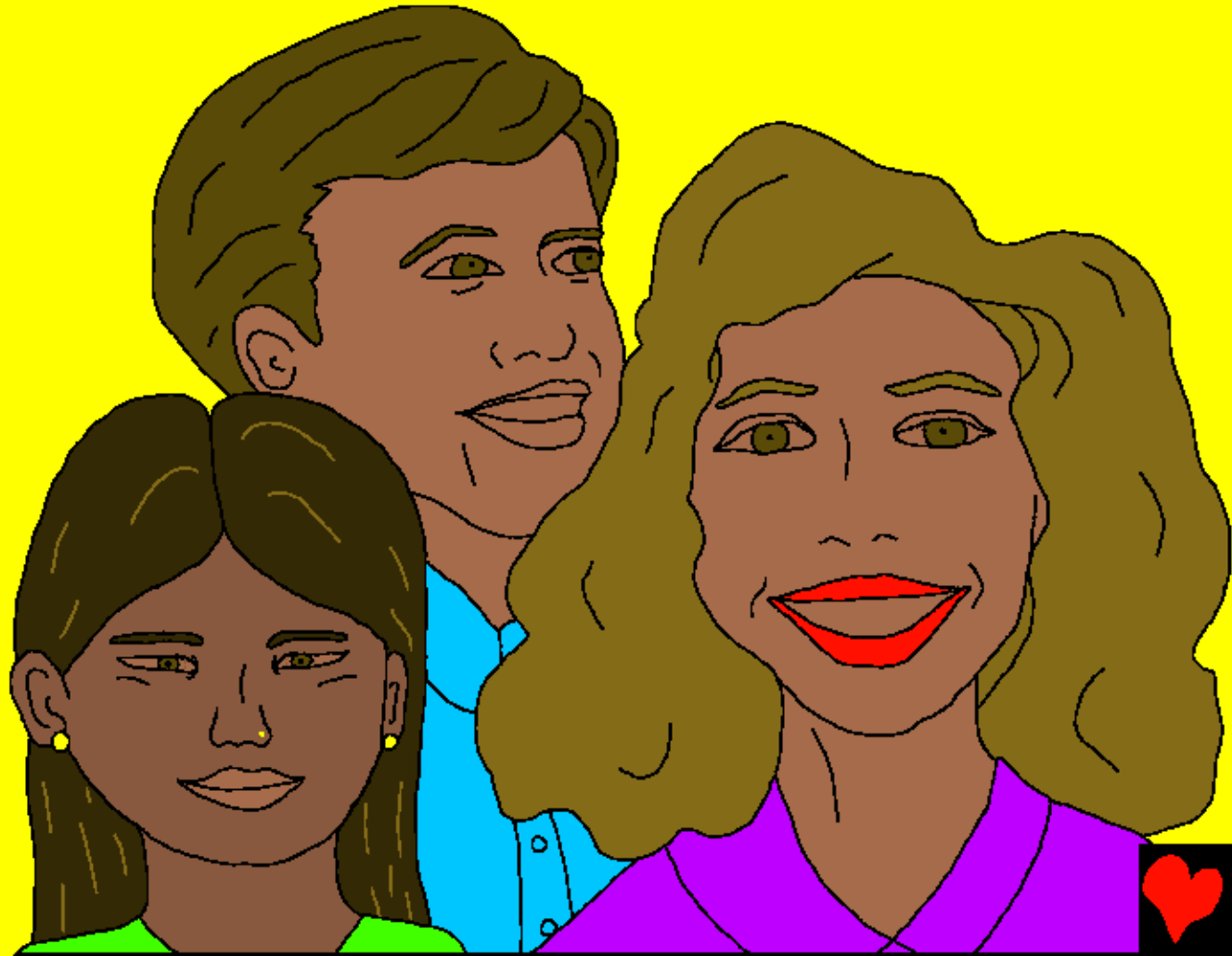

Iñaapoteeyerini maawaeni, eejatzi
Rojataakoeyakyaawoni ipankaki
iwaero, maawaeni.

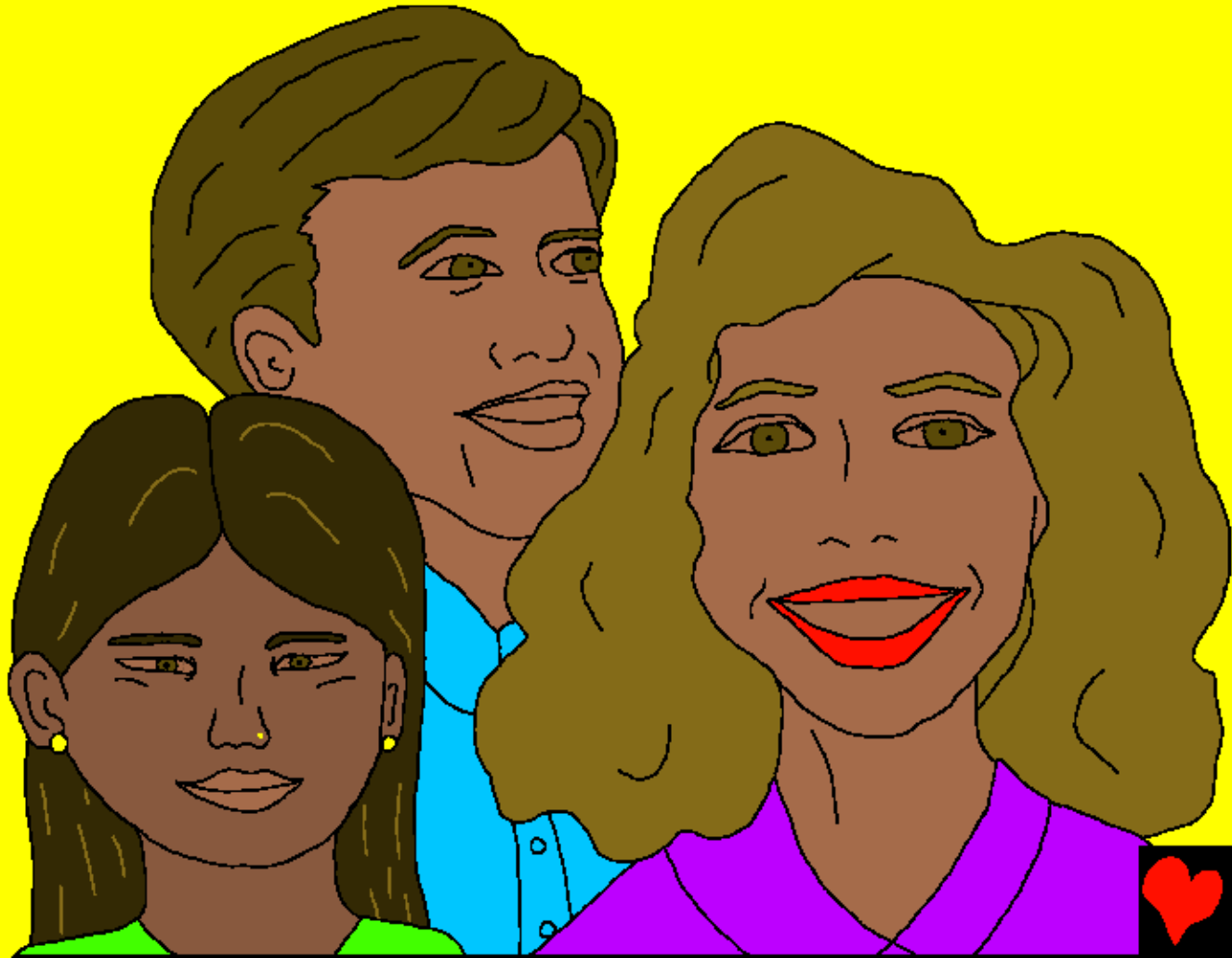

Eejatzi noñaakiri maawaeni piinkaeyawitacharini
inkaareki. Ipiriinteeyanaani tsitsiyawiteenchari
eejatzi maawaeni jateeyatsirini jaawiki. Kyaaryo,
noñeeyakirini: pinkatharitawitacharini eejatzi kaari
pinkatharitawitachani, ikatziyimoteeyakawoni
iwinkatharimento Tajorentsi. Roojatzi
roepithokakiro paajinapaeni osheki
Iwaperite rirori.
Ojankineeyakani
jankinarentsipaeni
maawaeni
ranteeyinirini
atziripaeni.

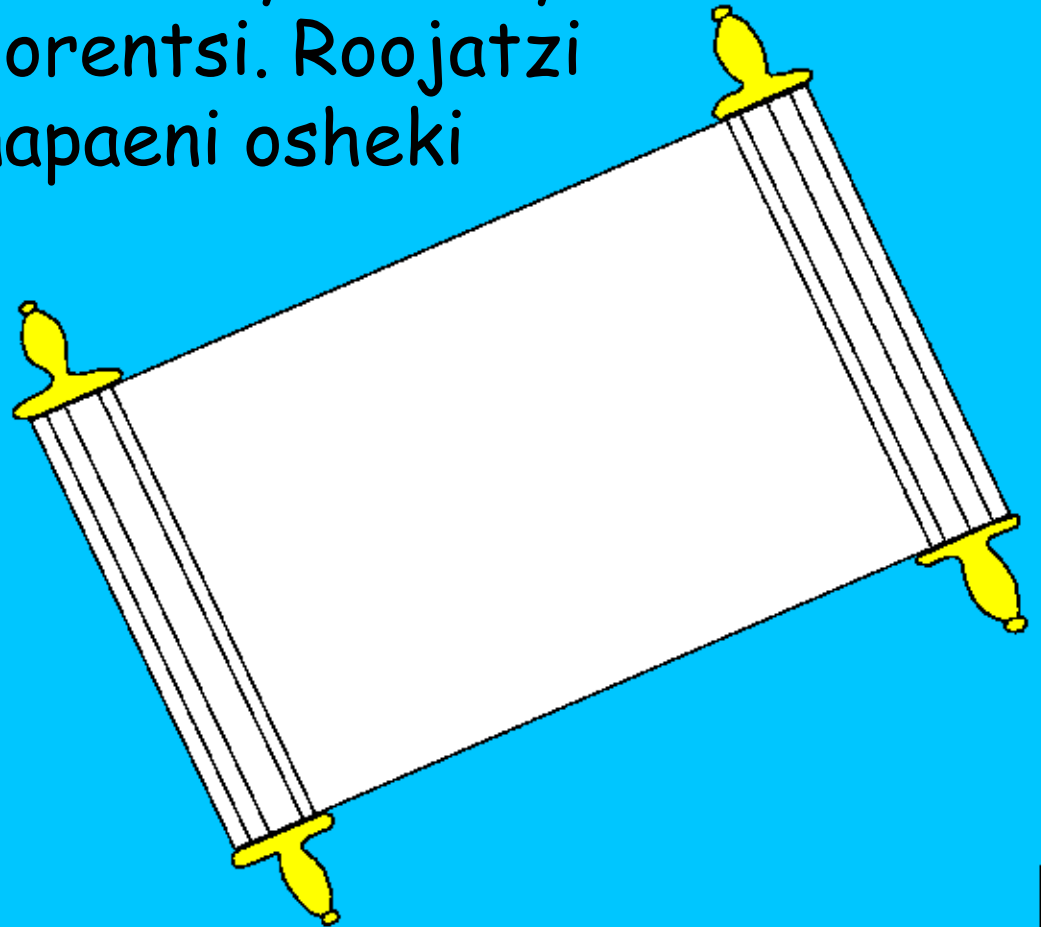

Aririka rantaneentero eechonkiini kaari
kameethatatsi ari omawitya rotyaanteri rirori irira
janta paamariki kaari tsiwakanitatsiri eero
ikemaatsitaperotawo katsiri. Omaanta riraga
antzirori osheki kaari kameethatatsi
osheki ikemaatsitaperotyawo katsiri.
Eenitatsi paashini iñaanamento rashi
rirori eejatzi, roepithokakiro
paajinapaeni
ojankinataka
iwaeropaeni
maawaeni
aapatziyariri
Jesoshi.

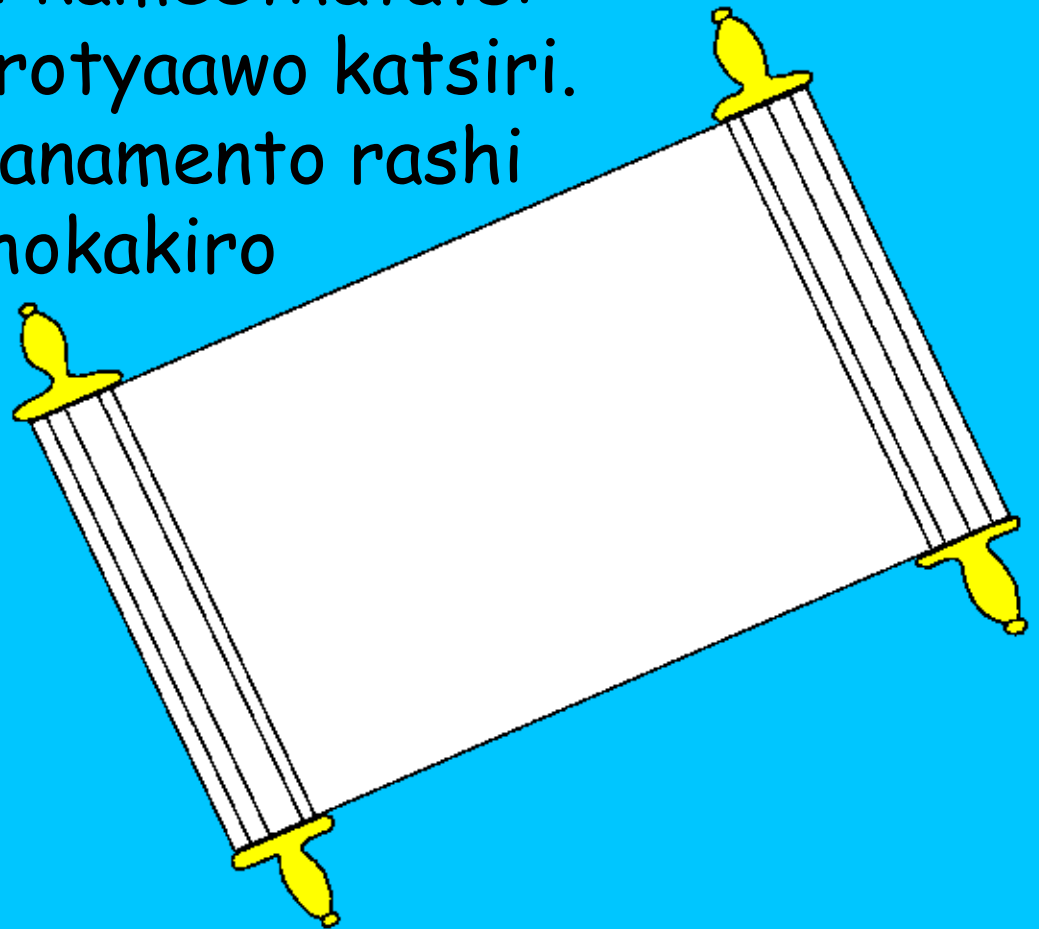

Riraga kaari jankinatakotacha rookaeteri janta
antawoki paamari: janta rookaeri Tajorentsi
maawaeni theenkantatsiri eejatzi maawaeni kamaari.
Iiteetziro paamari Inampi Ashironkaaperotachari:
riraga kaari ñaayiterini
Tajorentsi. Oshekipero
ikemaatsiperotakawo
katsiri janta
ikowaki ikamae
omaanta tee
imatziro,
eekiro riyaatatzi
Ikemaatsitaperotyaawo.

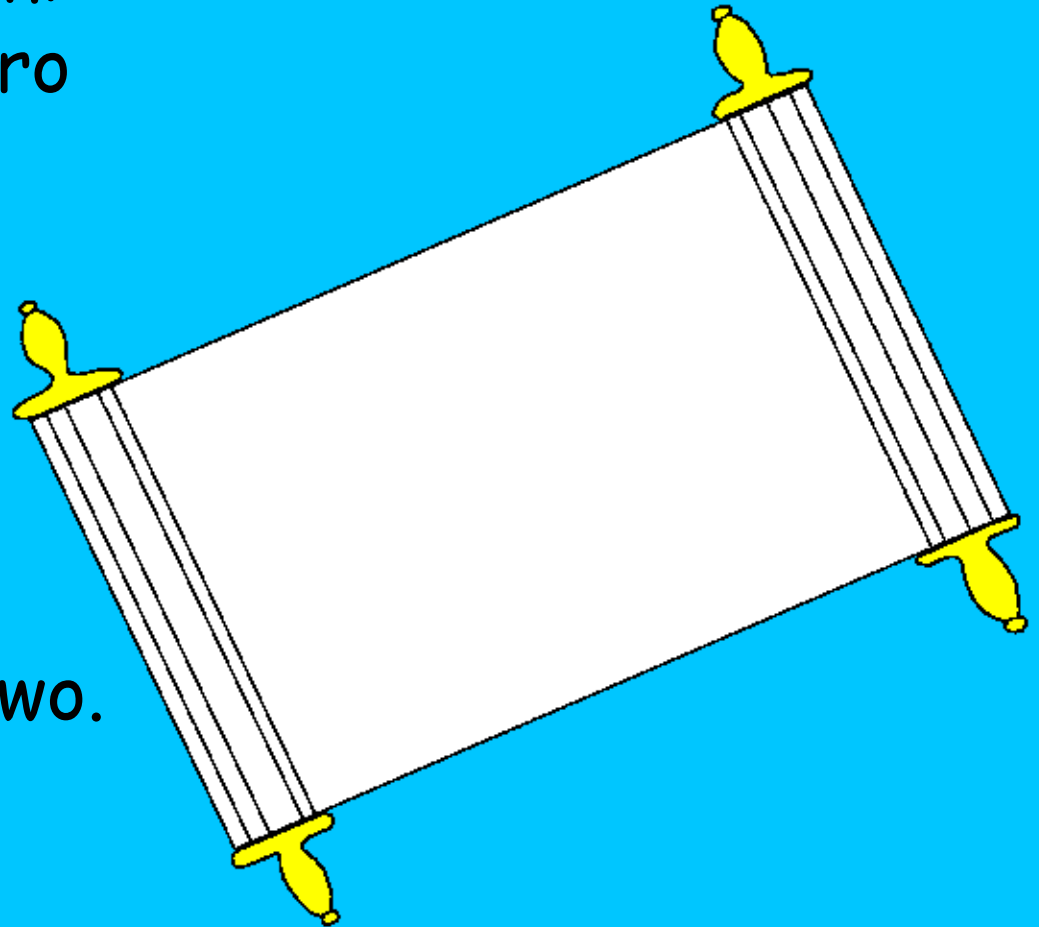

Ishire Tajorentsi eejatzi roori iinathori Rowishate
Tajorentsi, okanteeyirini: "Thame paapatziyari
Nowinkatharite". Thame maawaeni kemaeyirorini,
pikimateeyaawoni, pikanteeyeni:
"Thame paapatziyari Nowinkatharite".

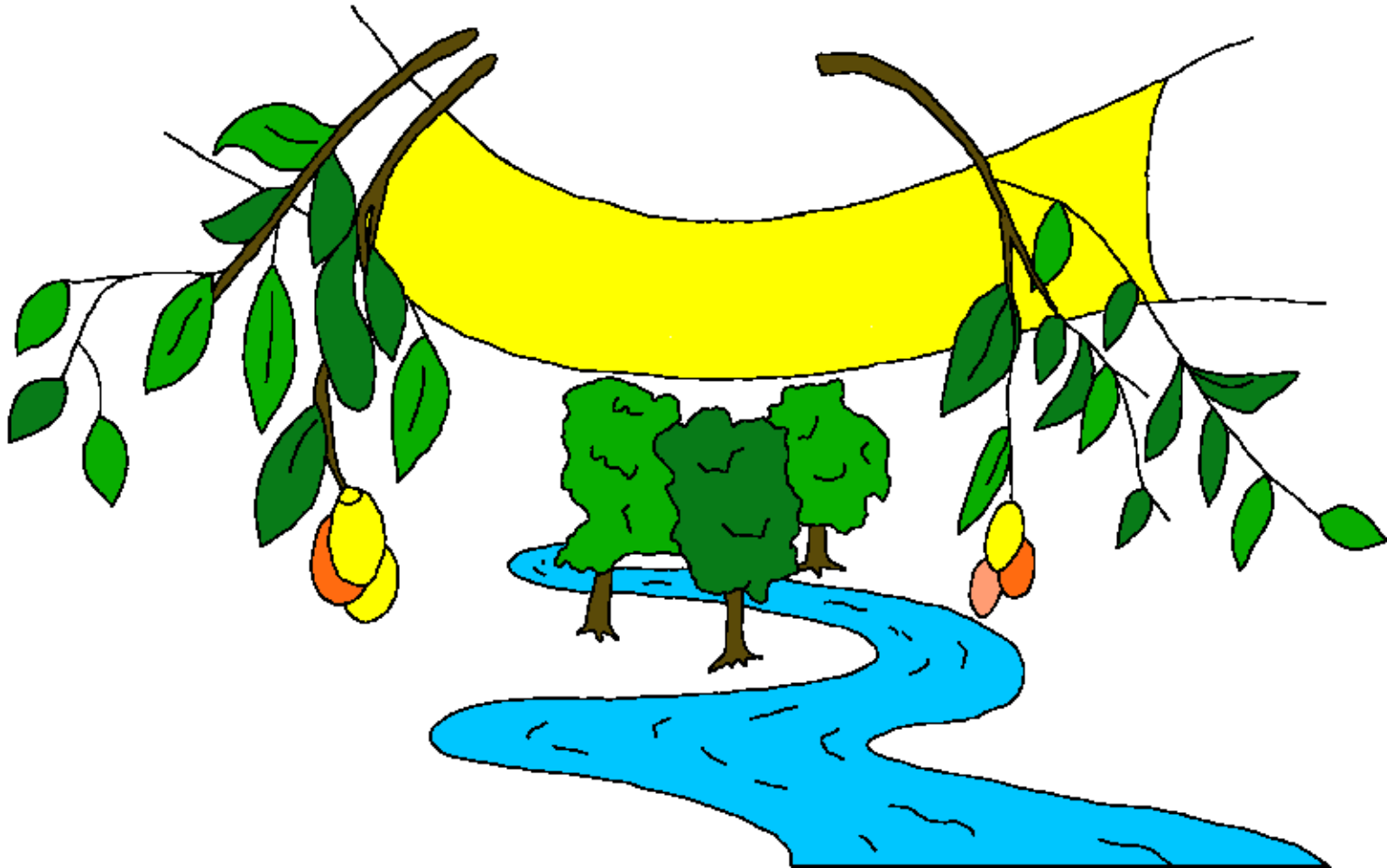

Eejatzi eerori, tsikarika piyeekaeyini:
noshiyakaawentemiro. Aririka pikemakiro pimir,
pameentyaari Nowinkatharite. Ninkarika kowaentsini
rire, pameenteeyarini: tema ipakimi iña
owañaantatsiri, tekatsi ikowakoeyemini.

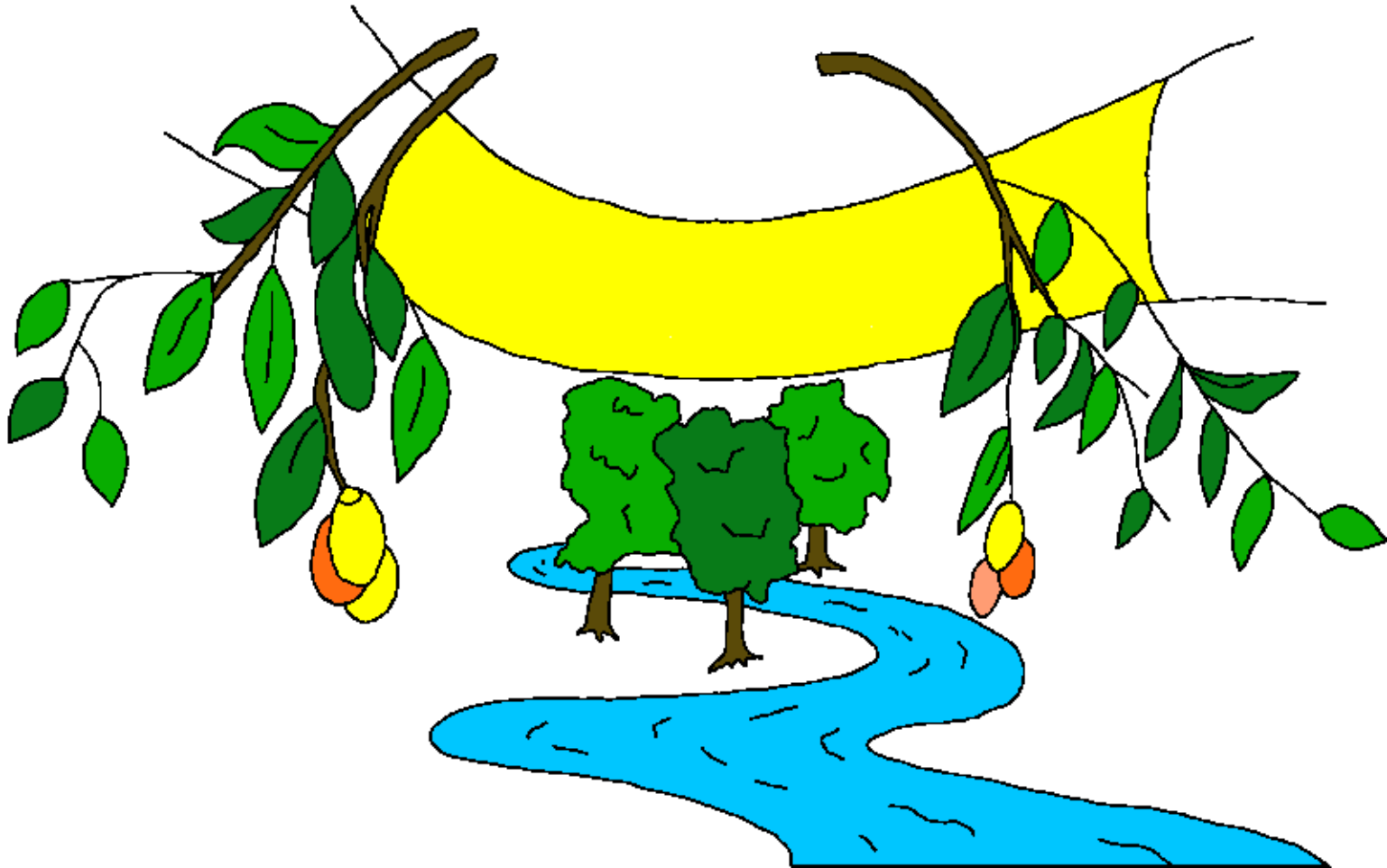

Inintashireperotanteeriroña riraga
Tajorentsi aakapaeni maawaeni
atziri kipatsikika, rootaki
rotyaanantakariri Itomi
rapintzite jaka
kipatsikika.



Ninkarika aapatziyeeyaaririni rirori,
eero riyaatzi paamariki kaari
tsiwakanitatsini, inta
ikanteetatyeeyaaani ijeeki
jenokinta itsipatapaeeyaaari
Tajorentsi.



Oroomajatzi 3:23 tema eeniro anteeyakironi
kaari kameethatatsi, maawaeni. Tee anteeyironi
kameethatayitatsirini ikowakagaeyakaerini
Tajorentsi.

Oroomajatzi 6:23 Pantapiinteeyawitakawoni
kaari kameethatatsi, piyaateeyantyaarinimi
paamariki kaari tsiwakanitatsini. Omaanta
paapatziyakari Awinkatharite Jesokirishito,
rootaki ikaminthaantashitakimiri Tajorentsi,
ijeekakagaeyashitemini jenokinta,
pikanteetapaatyeeyaani. Tema
ikaminthaashiiyeeni ikowashita.



Ijorriyotzinkarite 9:27 Ayoteeyakini apaani akamaeyakini, ari okaatzi; tee apiitapiintziro akame. Aririka akamae, roojatzi ikantakowenanteeyakaeni Tajorentsi, akameethatakirika.

Ejeesojatzi 2:8,9 Aapatziyaperotakari rootaki rowawijaakotantakaeri Tajorentsi. Tema osheki ineshironkataperoeyakaeni. Tekatsi akanteeya owawijaakotashiteya aaka, inta riro apaniroeni owawijaakotashiteeyakaerini.

Aakarikami owawijaakotashitachanimi, tema ari akantakaaperotakyaami.



Oroomajatzi 10:9,10 Aririka pikamanteri
paashinipaeni atziri pipinkathatakiri rirori,
eejatzi aririka pikenkithashiryakiro
pajankaneki ipiriinteeri Tajorentsi,
aritaki pawijakotee.

Ñaakiro, aririka ameentyaari riraga Jesoshi
ajankaneki iñaaperoeyeeni Ashitariri
akameethatzi; eejatzi aririka akamanteri
paashinipaeni atziri aapatziyakari rirori,
aritaki awijakotee.

Jowa 3:16,17 Inintashireperotanteeriroña
riraga Tajorentsi aakapaeni maawaeni atziri
kipatsikika, rootaki rotyaanantakariri Itomi
rapintzite jaka kipatsikika.



Ninkarika aapatziyeeyaaririni rirori, eero
riyaatzi paamariki kaari tsiwakanitatsini, inta
ikanteetatyeeyaani ijeeki jenokinta
itsipatapaeeyari Tajorentsi.

Tee ro rotyaanantariri Tajorentsi riraga Itomi
jaka rowashironkae aakapaeni atziri, inta
rotyaanantakaariri rowawijaakotee.

1 Jowa 5:11-13 Aapatziyakari aaka Itomi,
rootaki ijeekakaanteeri Tajorentsi aaka jaka
iroñaaka eejatzi iinja janta jenokinta,
akanteetatyeeyaani. Aritaki akanteetatyeeyaani
añaagae maawaeni ayoperotziri Itomi
eejatzi akempiyaminthatari.



Riraga kaari iyoperotziri, kaari owañi ishire
rootaki tekatsi ikantya rareetya
janta jenokinta.

Paapatziyakari Itomi Tajorentsi, iroñaaka
nojankinatzimiro piyotantyaari
pikanteetatyeeyaani añaagae pishire iroñaaka
eejatzi iinja janta jenokinta.



Jowa 14; 2 Korintojatzi 5;
Roñaagayitakirini 4, 21, 22

Storyline by: Edward D. Hughes

Illustrated by: Lazarus
and Alastair Paterson

Adapted by: Sarah S.

Ashéninka Pajonal Bible (cjo) © 2008, Wycliffe Bible
Translators, Inc. All rights reserved.

<https://live.bible.is/bible/CJOWBT/MAT/1>

©2024 Bible for Children, Inc.

www.M1914.org

www.bibleforchildren.org

