

[www.BibleForChildren.org](http://www.BibleForChildren.org)



Jowa 14



Eejatzi ikanteeyanakinani Jesoshi: —Eero pikenkithashiryaaashiipiintawo inta pameentyaari Tajorentsi. Eejatzi naari, pameentena. Janta inampiki Pawa eenitatsi oshekini pankotsipaeni. Eero oshekitzimi, ari nokantemimi: "Tee oshekitzi".



Niyaate janta niwetsikaeyapaemini pipanko,  
pijeekanteeyapaeyaarini eeroka iinja. Aririka  
nomatemiro pijeekantyaari, ari napiitaatero  
nopyashiiyakitemini nagaeyaatemini. Aritaki  
notsipatapaakimi nojeekinta naari.

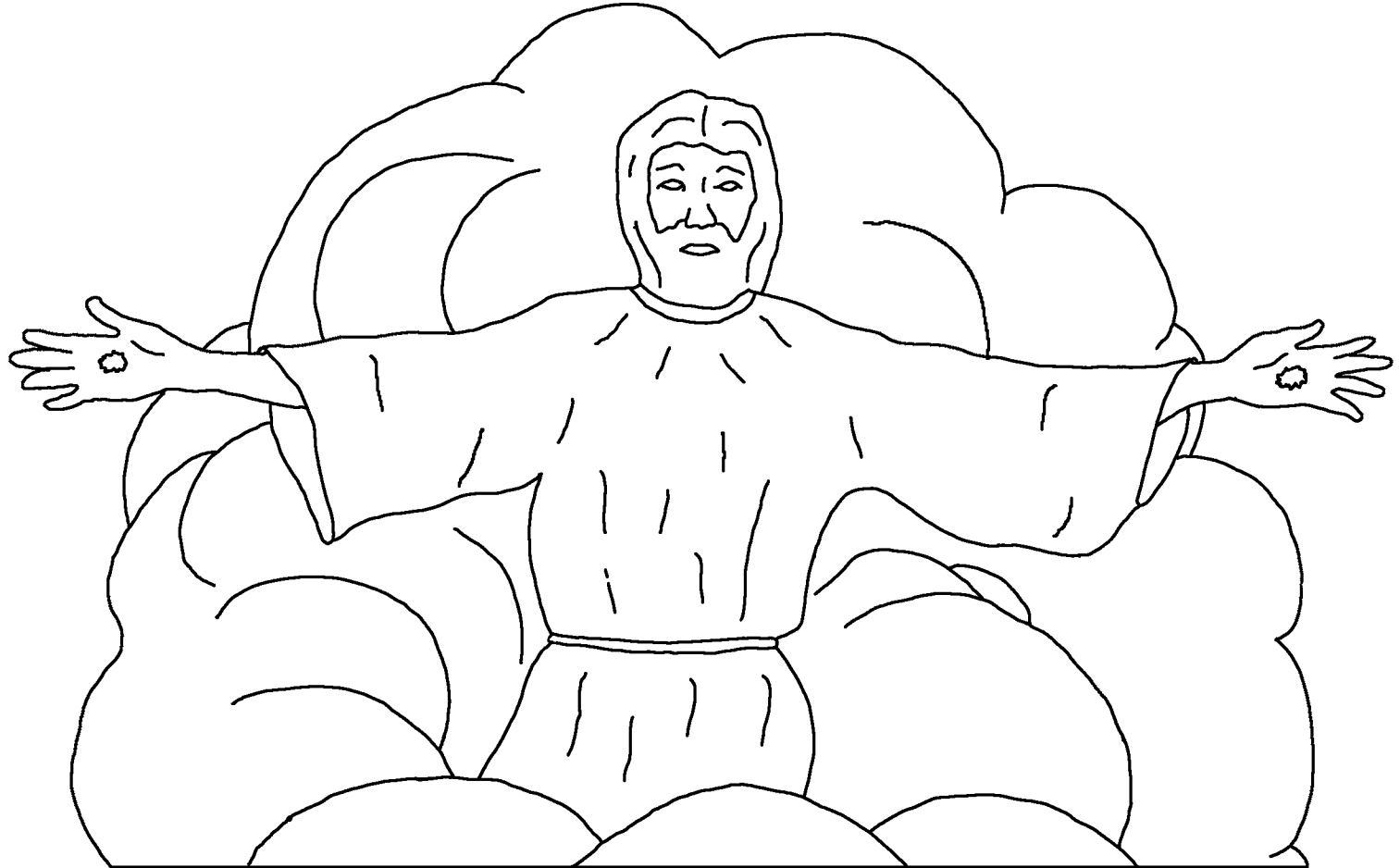

Ari, noyemijantzinkarite, akimitawakagaeyakani:  
aapatziyeeyakarini Jesoshi, rootaki  
rowashironkaapiinteeyantakaeri

theenkantatsiri.

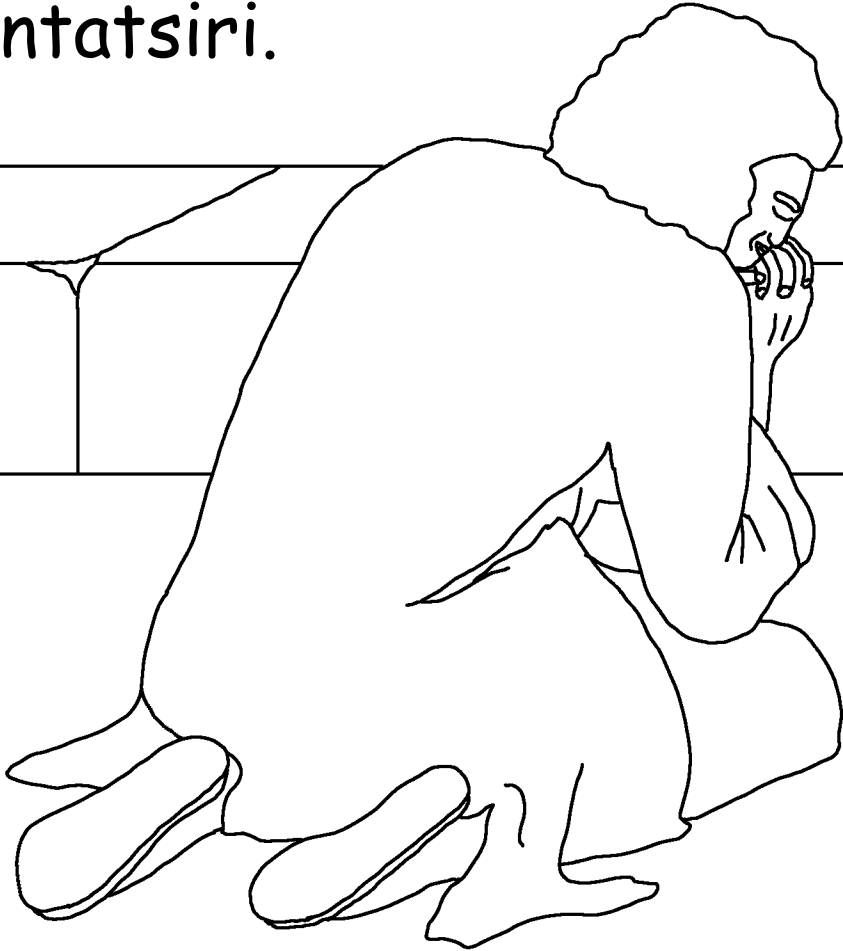

Ipinkathariwenteeyakaeni Jesoshi, rootaki  
amateeyantakaworini eshiwentakiro  
akemaatsitawentyaari irira.

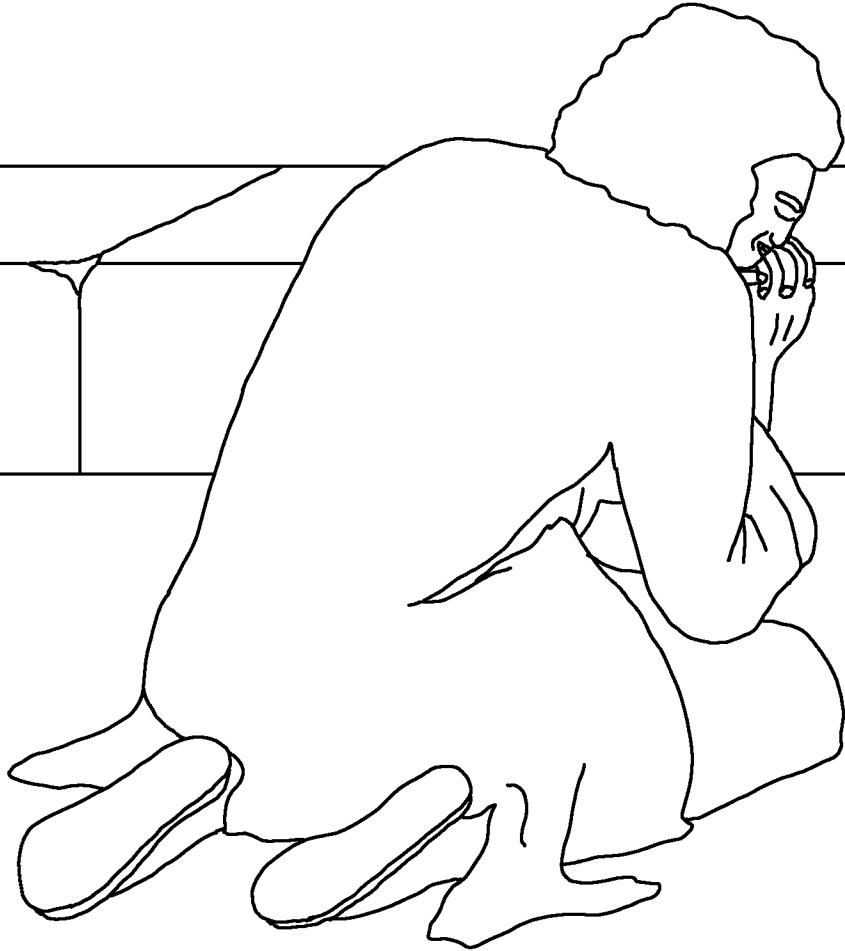

Nokenkithatziro iñaani Tajorentsi, tema  
nokenkithatakotakiri Jesoshi, rootaki  
rookanteetakinari jaka othampishiki

iiteetziri Paatzimoshi.

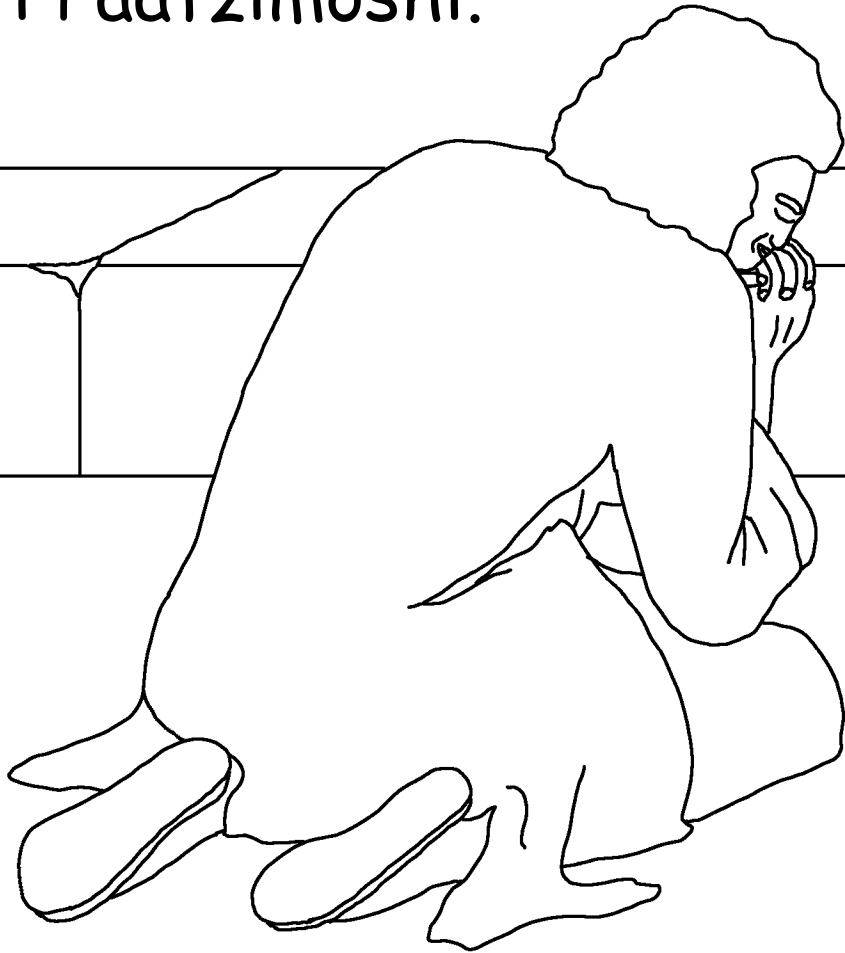

Rootaki omatakaakinawo Ishire niyaatantakari  
jenokinta. Janta noñaapaakiri ishipakiryaaiki  
ikimitakawo mapi iporeryaataki kityonkari eejatzi  
natsiryaaathari. Niyotantakariri riro Tajorentsi.  
Iyotaakina Ishire.

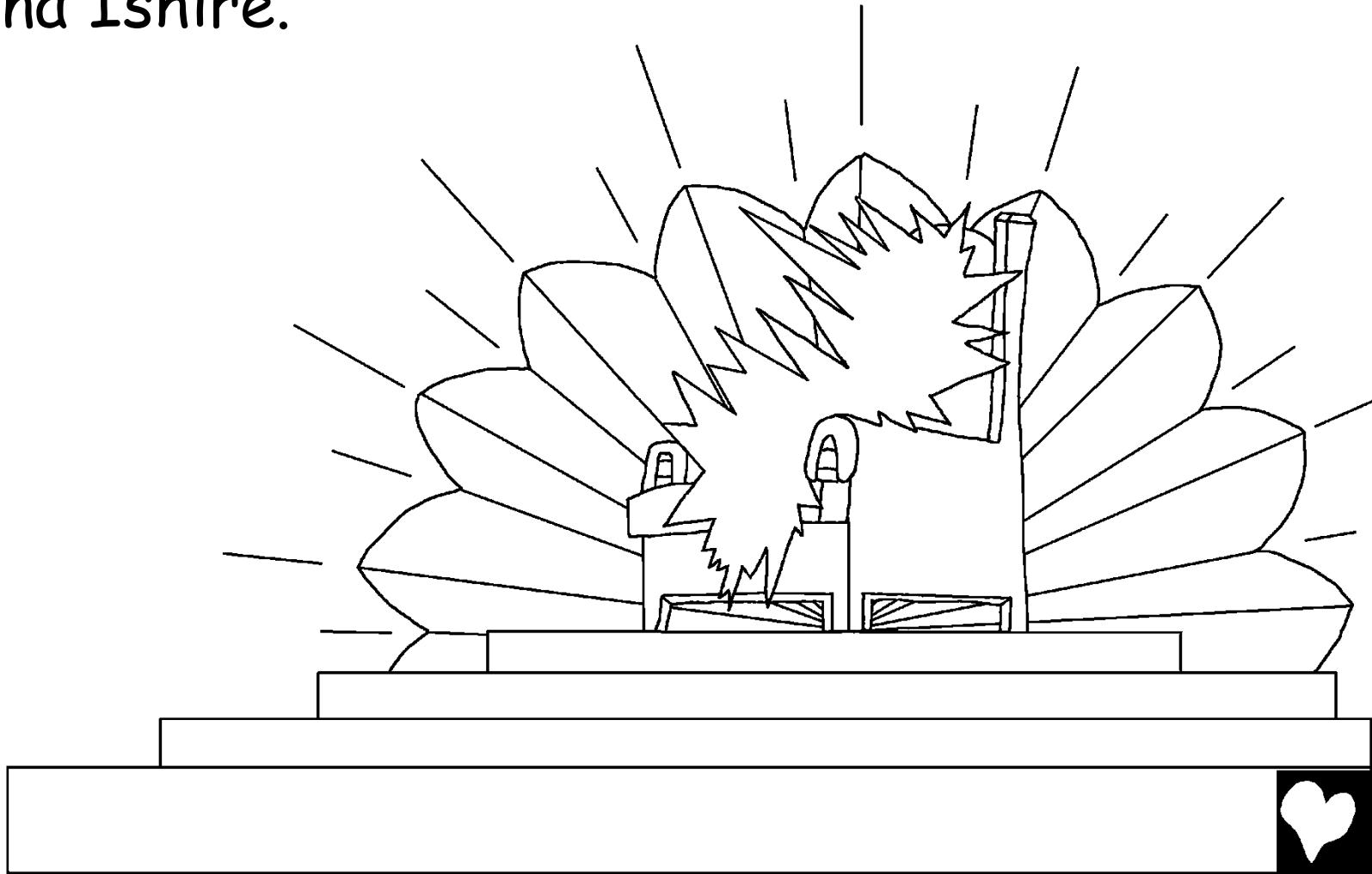

Eejatzi noñaakiri ijeekaki iwinkatharimentoki. Ari rinkinagaakitakiro kimitaka oye inta apaani ikanta natsiryathari. Ari ikanta ishipakiri. Omaanta Tajorentsi osheki ishipakiri, morek, morek, tharek, tharek, morek, tharek.

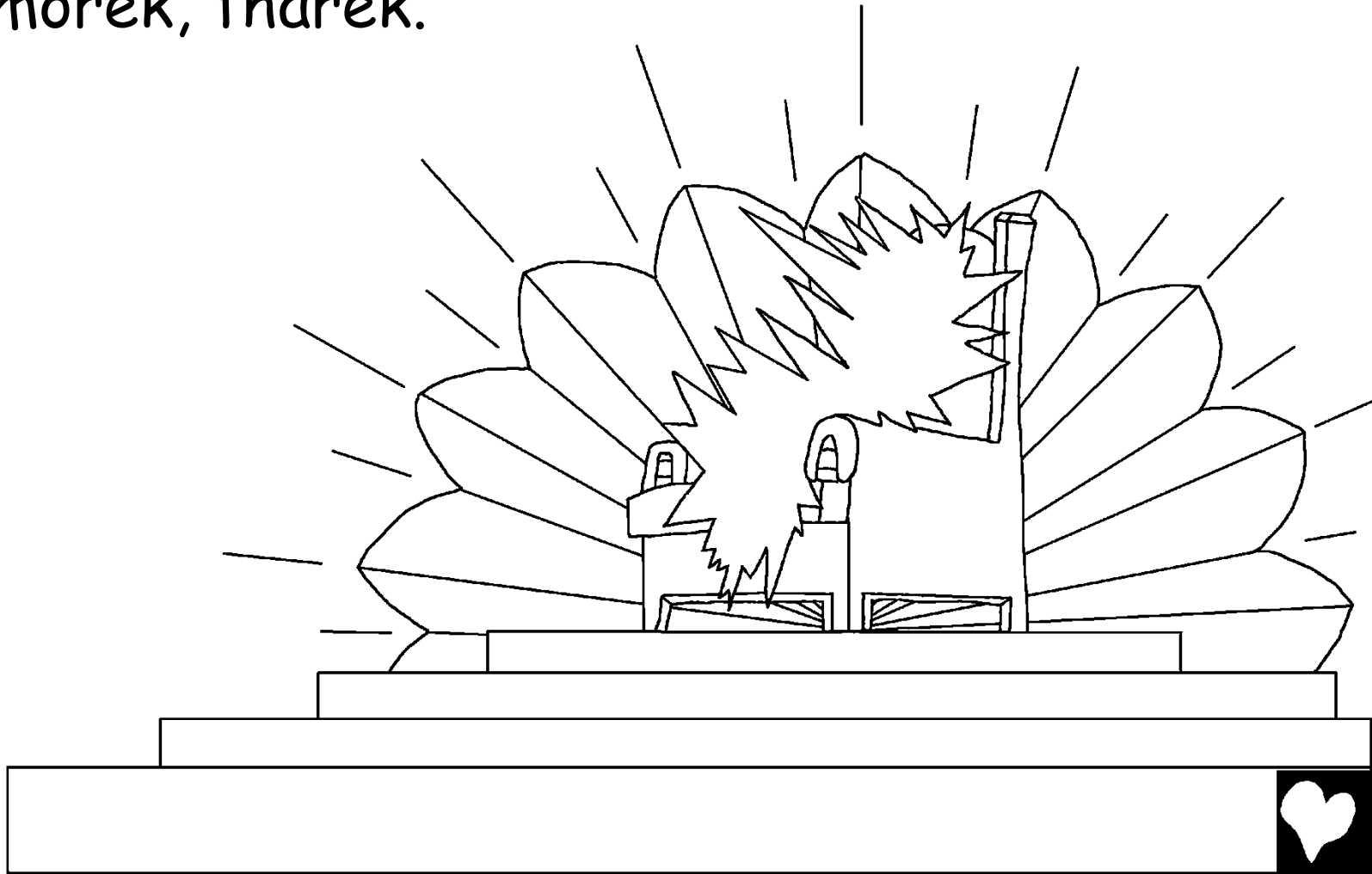

Eejatzi nokemaeyakirini maawaeni jeekatsiripaeni  
jenokinta, eejatzi kipatsiki, eejatzi maawaeni  
kamaeyawiteencharini: riraga  
kitatawiteenchari kipatsiki,  
eejatzi piinkawitachari;  
romampaawenteeyakarini  
maawaeni kameetha: ...

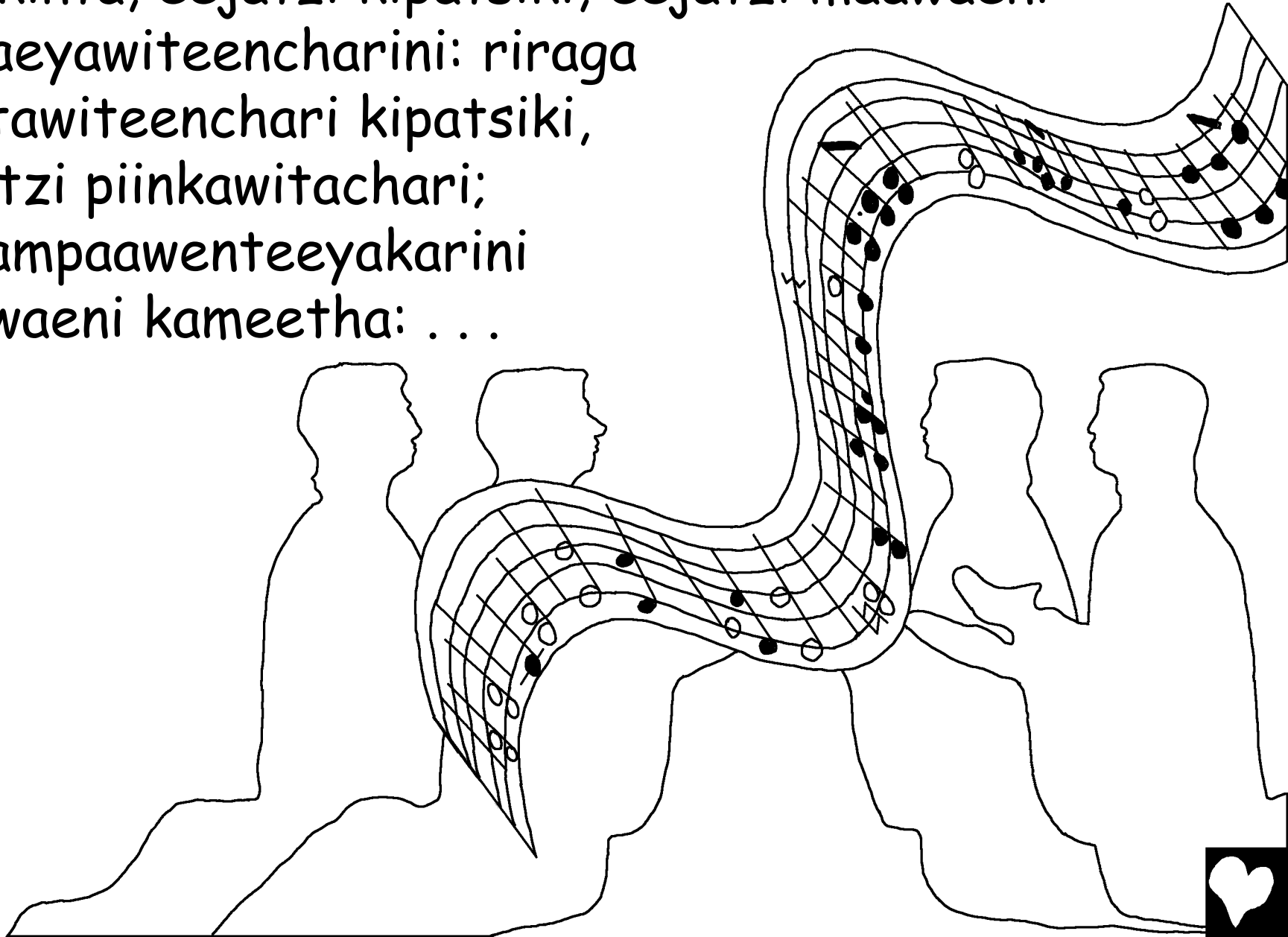

... "Thame Maawaeni aweshiryaaawenteeyaarini  
Tajorentsi jeekatsiri iwinkatharimentoki eejatzi  
Rowishate, apinkathateeyerini,  
añaperoyerini,  
akanteetatyeeyaani.  
Tema itajorentsitaperotaki,  
ikanteetatyeeyaani".

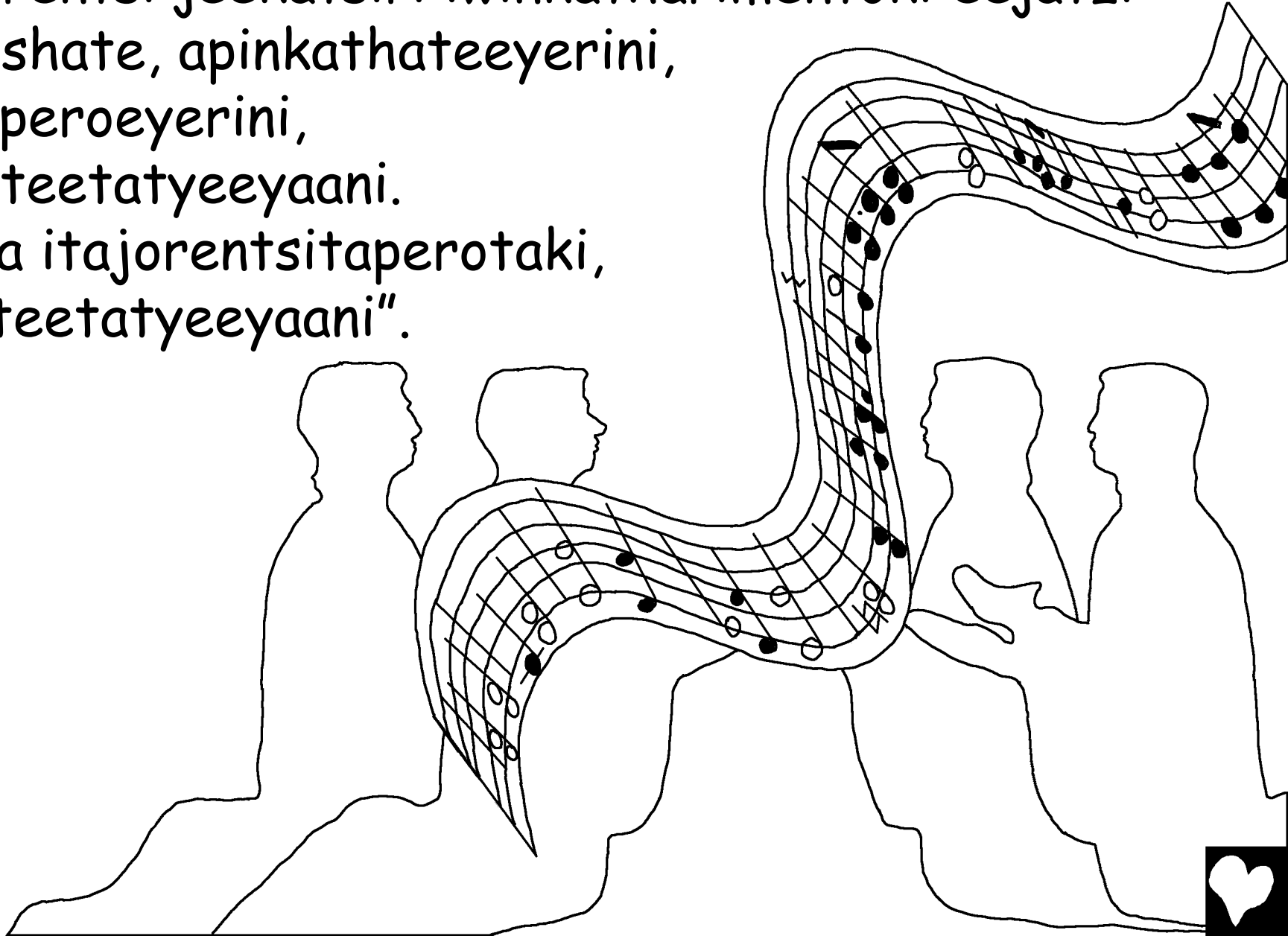

Eejatzi noñaakiro rowaga Jerojaree owakirari,  
rowaga kameethaperotatsiri inampi Tajorentsi;  
opoñaanaka jenokinta, ayiitapaaki kipatsiki. Osheki  
owaneenkayitakani, okimitakawo tsinani,  
rootentsirika aye oemi, owaneenkataka.

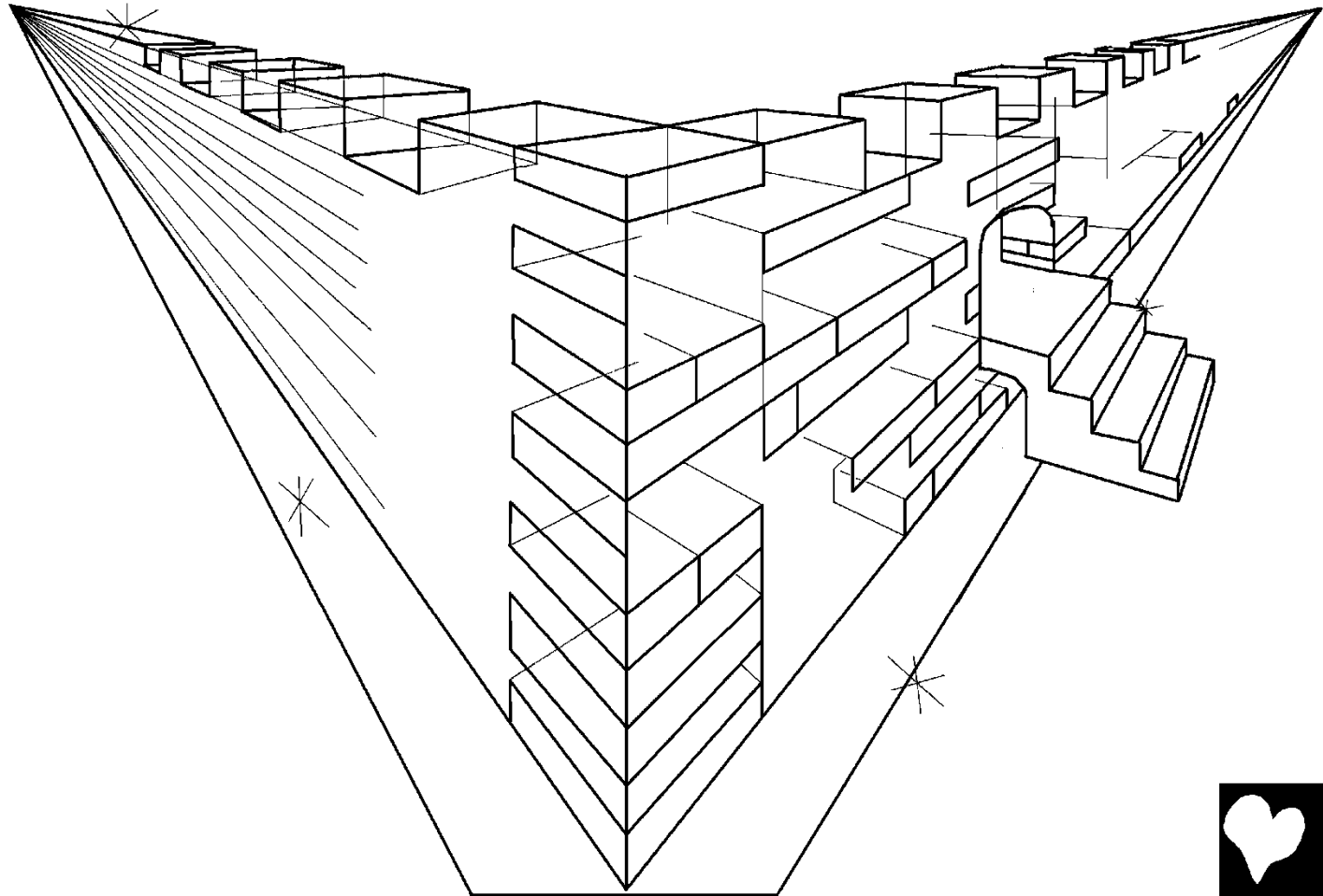

Nokemakiri jenokijatzi, jeekatsiri  
okaakini iwinkatharimentoki Tajorentsi.  
Itacheronkawaantetzi, ikantzi: —Pamineeyeni:  
riyaataki Tajorentsi jaawiki ijeekimoeyerini atziri.  
Kijokiro rowaeyerini, isheninkaeyantyaaririni. Eero  
rookaeyirini.  
Riroripaeni  
ipinkathateri  
apatziro rirori.

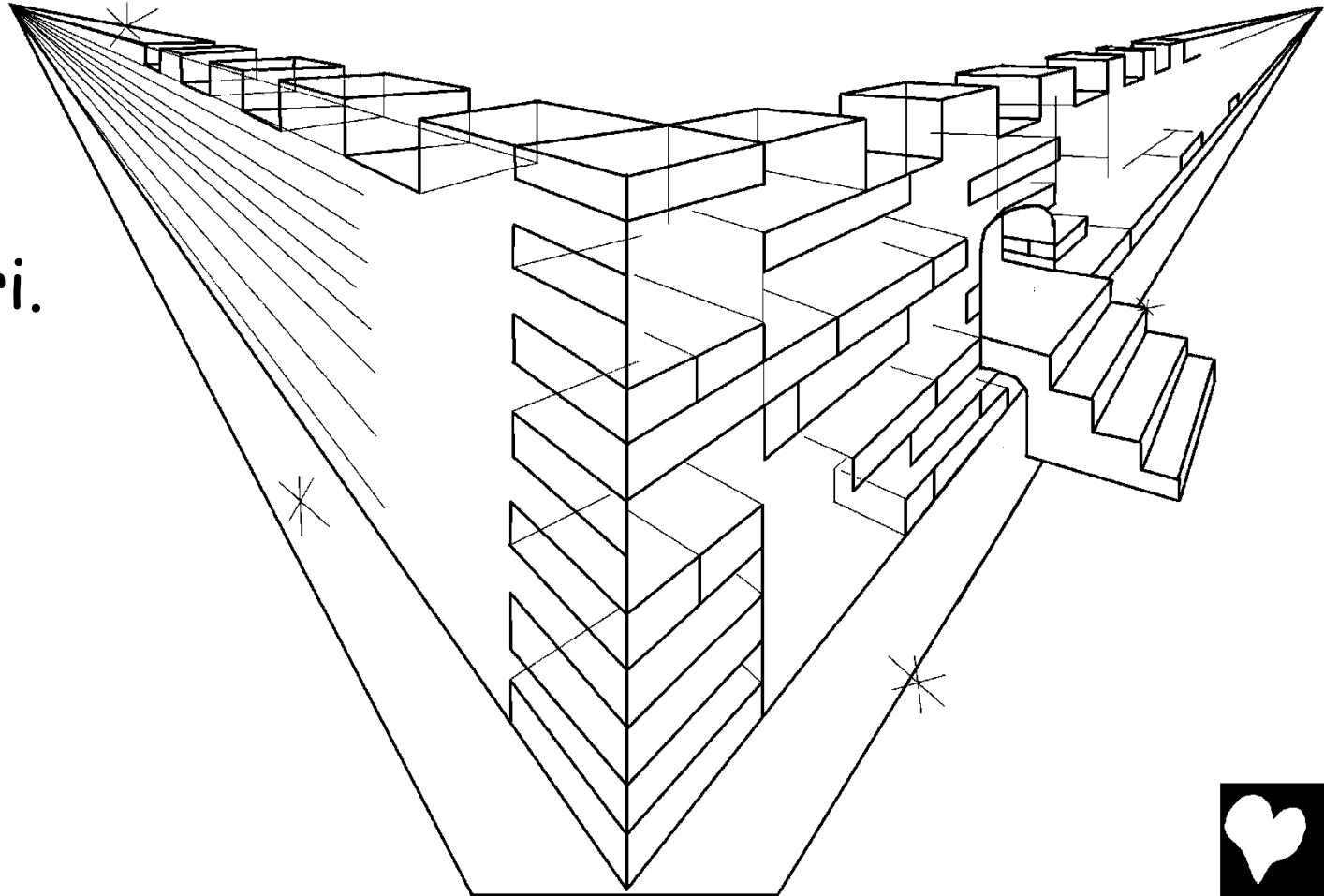

Roojatzi roñaagakinawo ronampiri Tajorentsi  
antaworoña eni, jaankanaanikitatsiri, ikanteetziro:  
iña owañaantatsiri. Oshiyakaawentzirori tsika  
ijeekakaantee akanteetatyeeyaani. Opoñaaka  
iwinkatharimentoki Tajorentsi eejatzi Rowishate,  
yowaatapaaki, shaaag.

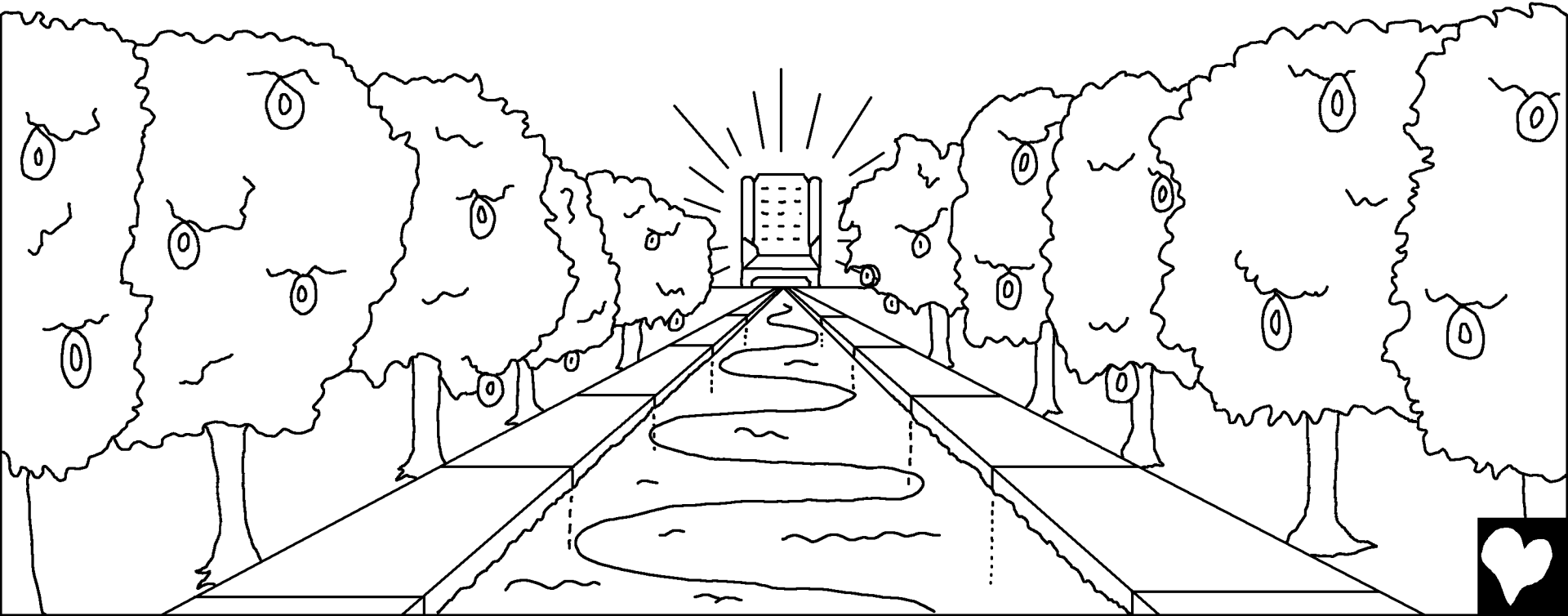

Tee ijeeki oorya roorenantyaawori nampitsi,  
eejatzi tekatsi kashiri kitamashiteroni: tekatsi  
ikowaeyantyaaririni. Tema ijeeki Tajorentsi, osheki  
ishipakiri okitejitantari nampitsi. Eejatzi ikimita  
Rowishate, roorentakoeyakaeni.

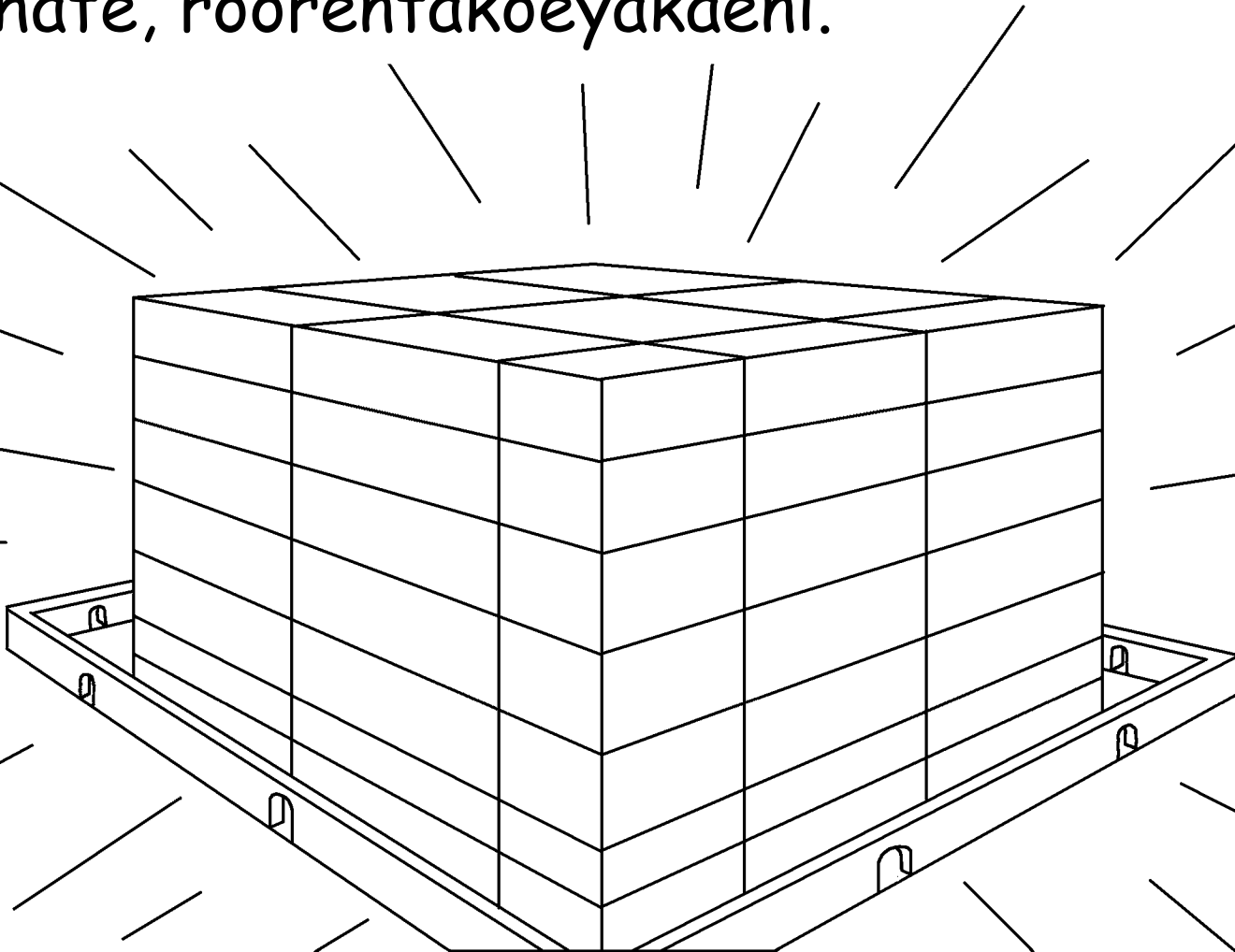

Eero okyaapae janta kaari kiteshiretayitatsirini  
oetarikapaeni. Eejatzi eero rareetanta  
antayitzirorini kaari  
kameethatayitatsini,  
tsikarika okantayitarini;  
eejatzi eero rareetanta  
amatawitantatsiri.



Omaantakya riraga areeteeyachani  
rirotaki jankinatakoeyacharini  
iwaeropaeni janta  
iñaanamentoki rashi  
Rowishate Tajorentsi.  
Riroteeyakini  
jeekatsini Tajorentsiki,  
ikanteetatyeeyaani.



Riweshiryakagaeyarini, eero  
ishinetziri atziri riragaeyeeyani  
eejatzi; eero ikamaeyeeni. Eero  
riraakotaari eejatzi  
kamaentsirini, eero ishenkataa,  
eero ikemaatsitaawo  
oetarikapaeni. Aritaki  
othonkyaari maawaeni  
irokapaeni. Tekatsi.



Eero añiïro janta nampitsiki kaari iñaaperotziri  
Tajorentsi kameethatayitatsini; tema janta ijeeki  
rirori eejatzi Rowishate. Ipinkatheeyerini maawaeni  
atziri janta, tema riroteeyakini aapatziyeeyaririni  
Jesoshi.



Iñaapoteeyerini maawaeni, eejatzi  
Rojataakoeyakyaawoni ipankaki  
iwaero, maawaeni.



Eejatzi noñaakiri maawaeni piinkaeyawitacharini  
inkaareki. Ipiriinteeyanaani tsitsiyawiteenchari  
eejatzi maawaeni jateeyatsirini jaawiki. Kyaaryo,  
noñeeyakirini: pinkatharitawitacharini eejatzi kaari  
pinkatharitawitachani, ikatziyimoteeyakawoni  
iwinkatharimento Tajorentsi. Roojatzi  
roepithokakiro paajinapaeni osheki  
Iwaperite rirori.

Ojankineeyakani  
jankinarentsipaeni  
maawaeni  
ranteeyinirini  
atziripaeni.

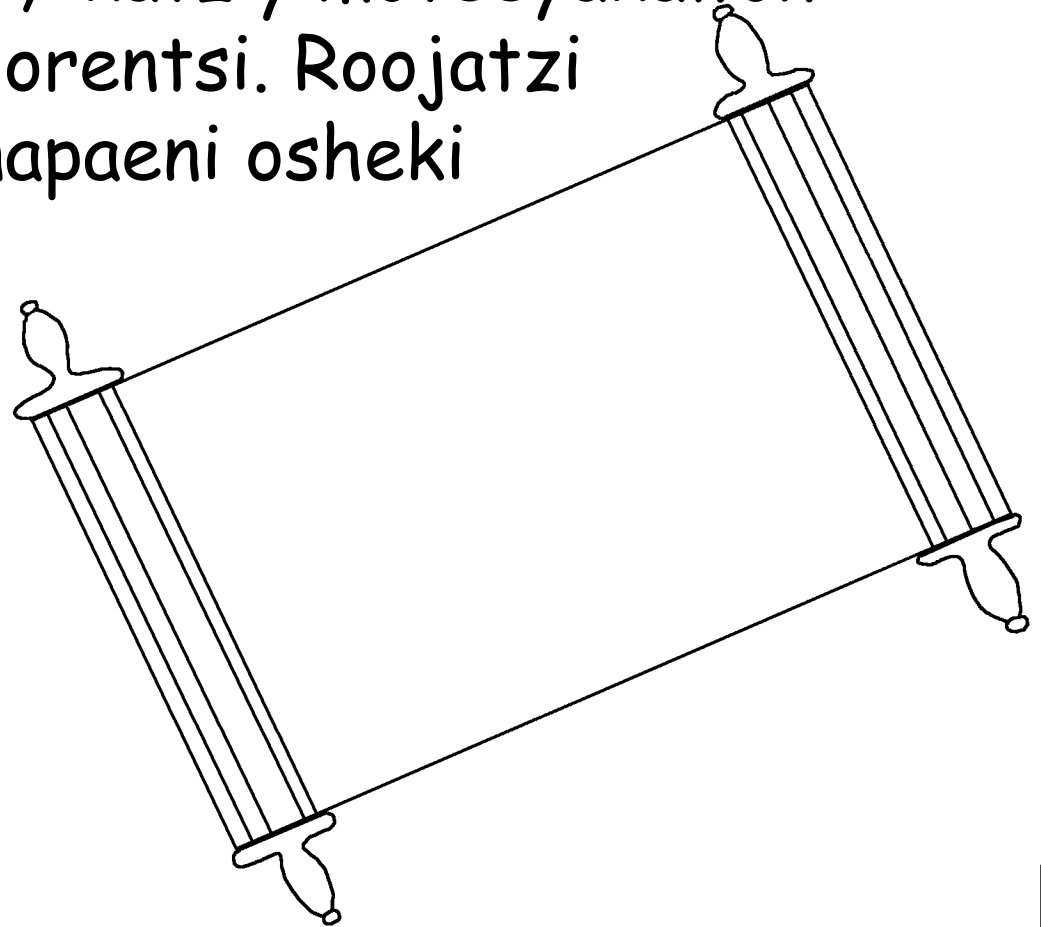

Aririka rantaneentero eechonkiini kaari  
kameethatatsi ari omawitya rotyaanteri rirori irira  
janta paamariki kaari tsiwakanitatsiri eero  
ikemaatsitaperotawo katsiri. Omaanta riraga  
antzirori osheki kaari kameethatatsi  
osheki ikemaatsitaperotyawo katsiri.  
Eenitatsi paashini iñaanamento rashi  
rirori eejatzi, roepithokakiro  
paajinapaeni  
ojankinataka  
iwaeropaeni  
maawaeni  
aapatziyariri  
Jesoshi.

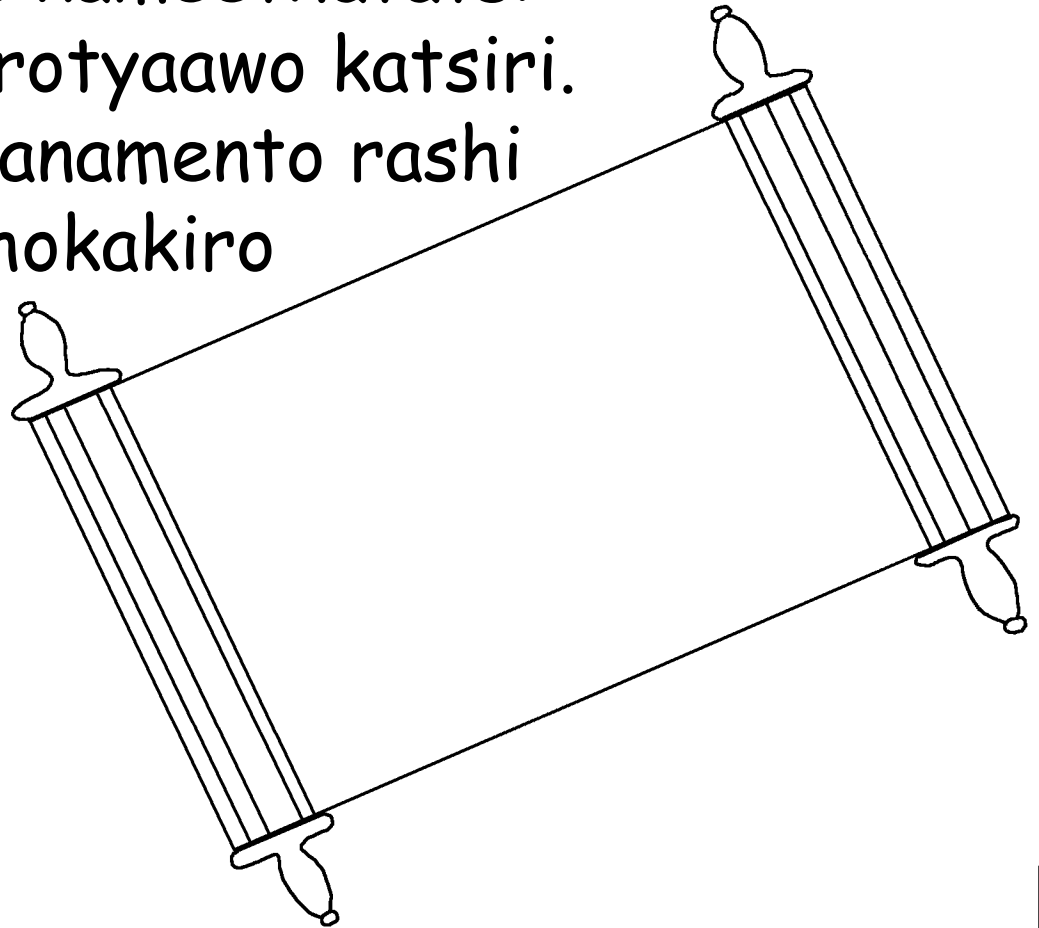

Riraga kaari jankinatakotacha rookaeteri janta  
antawoki paamari: janta rookaeri Tajorentsi  
maawaeni theenkantatsiri eejatzi maawaeni kamaari.  
Iiteetziro paamari Inampi Ashironkaaperotachari:  
riraga kaari ñaayiterini  
Tajorentsi. Oshekipero  
ikemaatsiperotakawo  
katsiri janta  
ikowaki ikamae  
omaanta tee  
imatziro,  
eekiro riyaatatzi  
Ikemaatsitaperotyaawo.

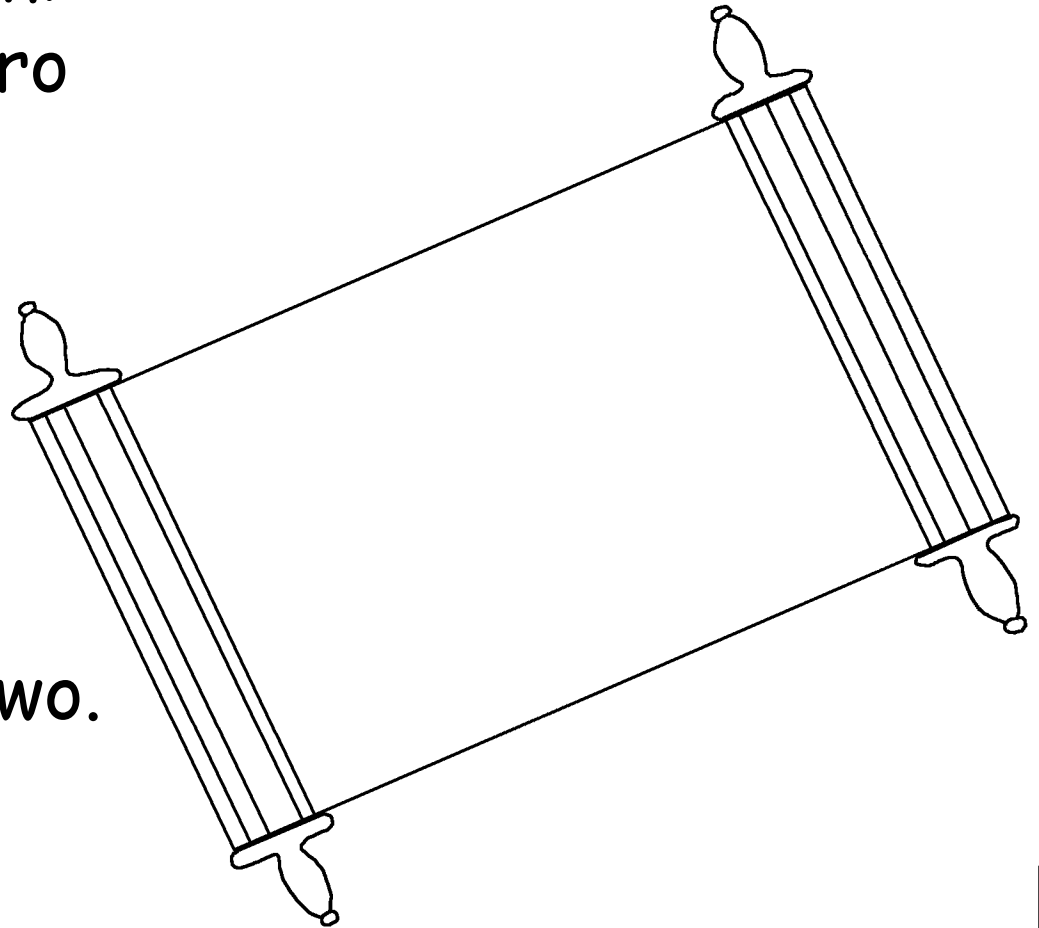

Ishire Tajorentsi eejatzi roori iinathori Rowishate  
Tajorentsi, okanteeyirini: "Thame paapatziyari  
Nowinkatharite". Thame maawaeni kemaeyirorini,  
pikimateeyaawoni, pikanteeyeni:  
"Thame paapatziyari Nowinkatharite".

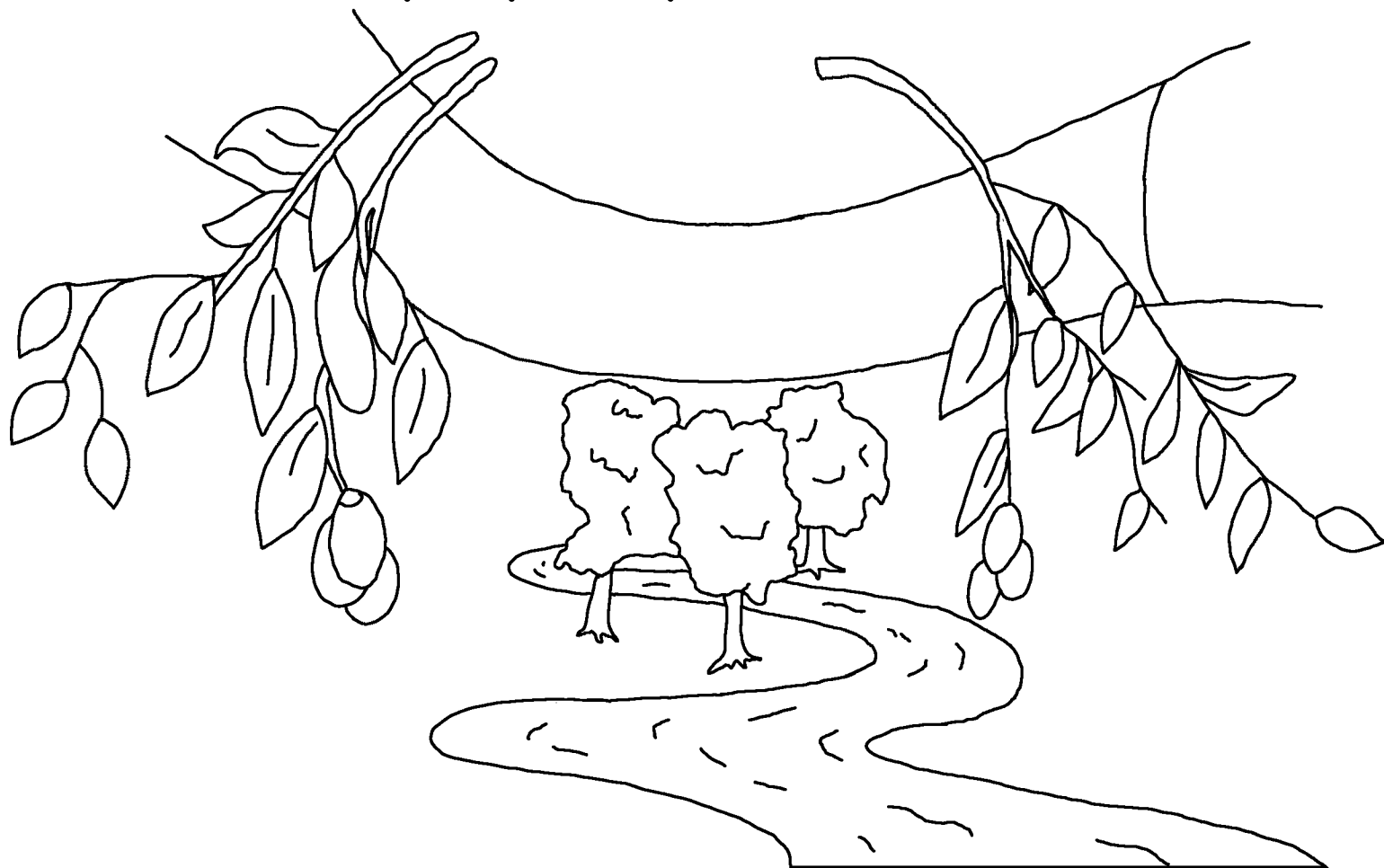

Eejatzi eerori, tsikarika piieekaeyini:  
noshiyakaawentemiro. Aririka pikemakiro pimir,  
pameentyaari Nowinkatharite. Ninkarika kowaentsini  
rire, pameenteeyarini: tema ipakimi iña  
owañaantatsiri, tekatsi ikowakoeyemini.



Inintashireperotanteeriroña riraga  
Tajorentsi aakapaeni maawaeni  
atziri kipatsikika, rootaki  
rotyaanantakariri Itomi  
rapintzite jaka  
kipatsikika.



Ninkarika aapatziyeeyaaririni rirori,  
eero riyaatzi paamariki kaari  
tsiwakanitatsini, inta  
ikanteetatyeeyaani ijeeki  
jenokinta itsipatapaeeyari  
Tajorentsi.



Oroomajatzi 3:23 tema eeniro anteeyakironi  
kaari kameethatatsi, maawaeni. Tee anteeyironi  
kameethatayitatsirini ikowakagaeyakaerini  
Tajorentsi.

Oroomajatzi 6:23 Pantapiinteeyawitakawoni  
kaari kameethatatsi, piyaateeyantyaarinimi  
paamariki kaari tsiwakanitatsini. Omaanta  
paapatziyakari Awinkatharite Jesokirishito,  
rootaki ikaminthaantashitakimiri Tajorentsi,  
ijeekakagaeyashitemini jenokinta,  
pikanteetapaatyeeyaani. Tema  
ikaminthaashiiyeeni ikowashita.



Ijorriyotzinkarite 9:27 Ayoteeyakini apaani akamaeyakini, ari okaatzi; tee apiitapiintziro akame. Aririka akamae, roojatzi ikantakowenanteeyakaeni Tajorentsi, akameethatakirika.

Ejeesojatzi 2:8,9 Aapatziyaperotakari rootaki rowawijaakotantakaeri Tajorentsi. Tema osheki ineshironkataperoeyakaeni. Tekatsi akanteeya owawijaakotashiteya aaka, inta riro apaniroeni owawijaakotashiteeyakaerini. Aakarikami owawijaakotashitachanimi, tema ari akantakaaperotakyaami.



Oroomajatzi 10:9,10 Aririka pikamanteri  
paashinipaeni atziri pipinkathatakiri rirori,  
eejatzi aririka pikenkithashiryakiro  
pajankaneki ipiriinteeri Tajorentsi,  
aritaki pawijakotee. Ñaakiro, aririka  
ameentyaari riraga Jesoshi ajankaneki  
iñaaperoeyeeni Ashitariri akameethatzi; eejatzi  
aririka akamanteri paashinipaeni atziri  
aapatziyakari rirori, aritaki awijakotee.

Jowa 3:16,17 Inintashireperotanteeriroña  
riraga Tajorentsi aakapaeni maawaeni atziri  
kipatsikika, rootaki rotyaanantakariri Itomi  
rapintzite jaka kipatsikika.



Ninkarika aapatziyeeyaaririni rirori, eero riyaatzi paamariki kaari tsiwakanitatsini, inta ikanteetatyeeyaani ijeeki jenokinta itsipatapaeeyari Tajorentsi. Tee ro rotyaanantariri Tajorentsi riraga Itomi jaka rowashironkae aakapaeni atziri, inta rotyaanantakaariri rowawijaakotee.

1 Jowa 5:11-13 Aapatziyakari aaka Itomi, rootaki ijeekakaanteeri Tajorentsi aaka jaka iroñaaka eejatzi iinja janta jenokinta, akanteetatyeeyaani. Aritaki akanteetatyeeyaani añaagae maawaeni ayoperotziri Itomi eejatzi akempiyaminthatari.



Riraga kaari iyoperotziri, kaari owañi ishire  
rootaki tekatsi ikantya rareetya janta  
jenokinta. Paapatziyakari Itomi Tajorentsi,  
iroñaaka nojankinatzimiro piyotantyaari  
pikanteetatyeeyaani añaagae pishire iroñaaka  
eejatzi iinja janta jenokinta.



Jowa 14; 2 Korintojatzi 5;  
Roñaagayitakirini 4, 21, 22

Storyline by: Edward D. Hughes

Illustrated by: Lazarus  
and Alastair Paterson

Adapted by: Sarah S.

Ashéninka Pajonal Bible (cjo) © 2008, Wycliffe Bible  
Translators, Inc. All rights reserved.

<https://live.bible.is/bible/CJOWBT/MAT/1>

©2026 Bible for Children, Inc.

[www.M1914.org](http://www.M1914.org)

[www.bibleforchildren.org](http://www.bibleforchildren.org)

