

www.BibleForChildren.org

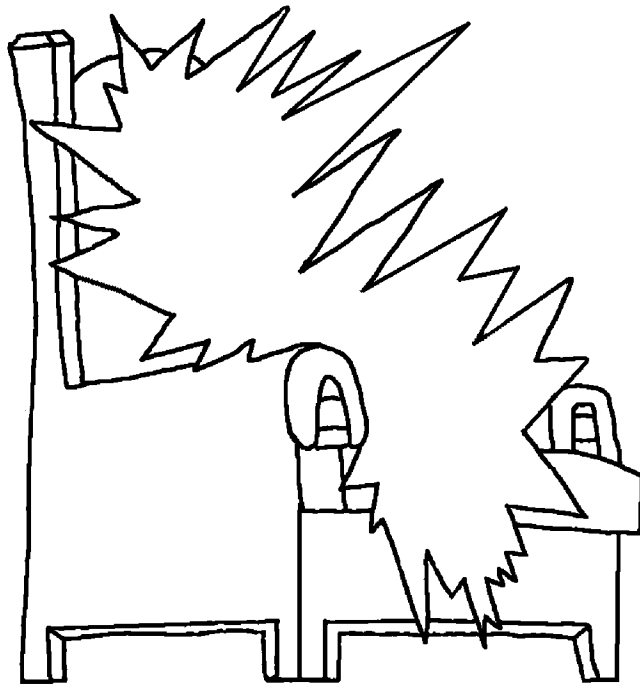

Yohanes 14



Yesus me asiino, "Ikii dimi se gaagaa taai, Oगतamee
kaa dimi magaai, Ni kaa miya dimi namagaai. Neataagi
me ee kaa kiyoo umiwoo, toowoo taano yoo maamaa
eebaa. Anii ikii me umiwoo, toowoo taano yoo kuwa
kiipiipii taano see
naadi poopa."

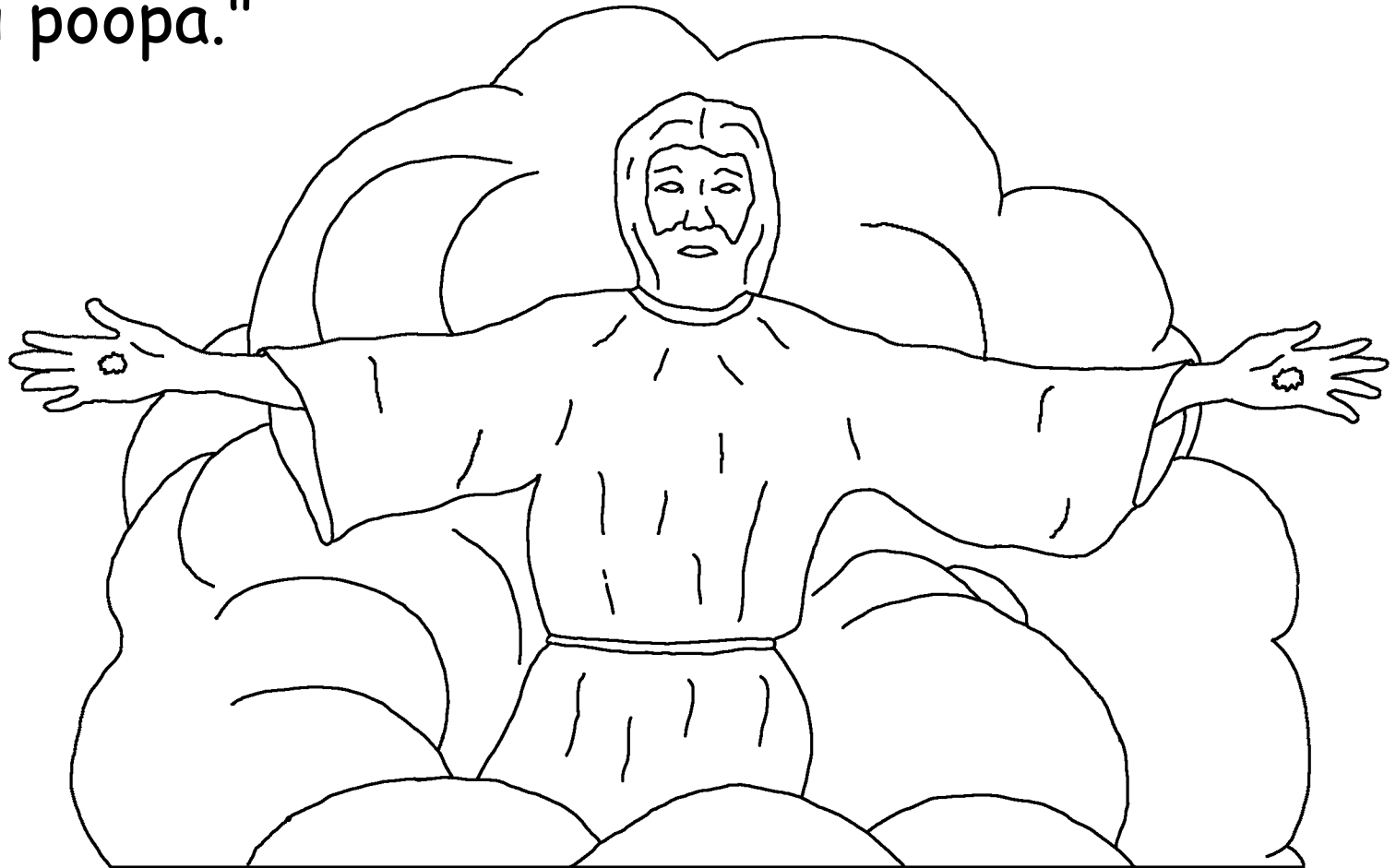

"Kisee taa naaki Anii kuwa menaa se kisiyaa. Anii peemaata kaama ikii me umiwoo, toowoo taano yoo kiipiipii semaata kaama epeekaa bedaa metaki kimeeta. Ni me toogee yoo kiyoo ikii miya Anii ma epo enaataa niiumiwoo, toowoosea naadi badaa kimaagiita."

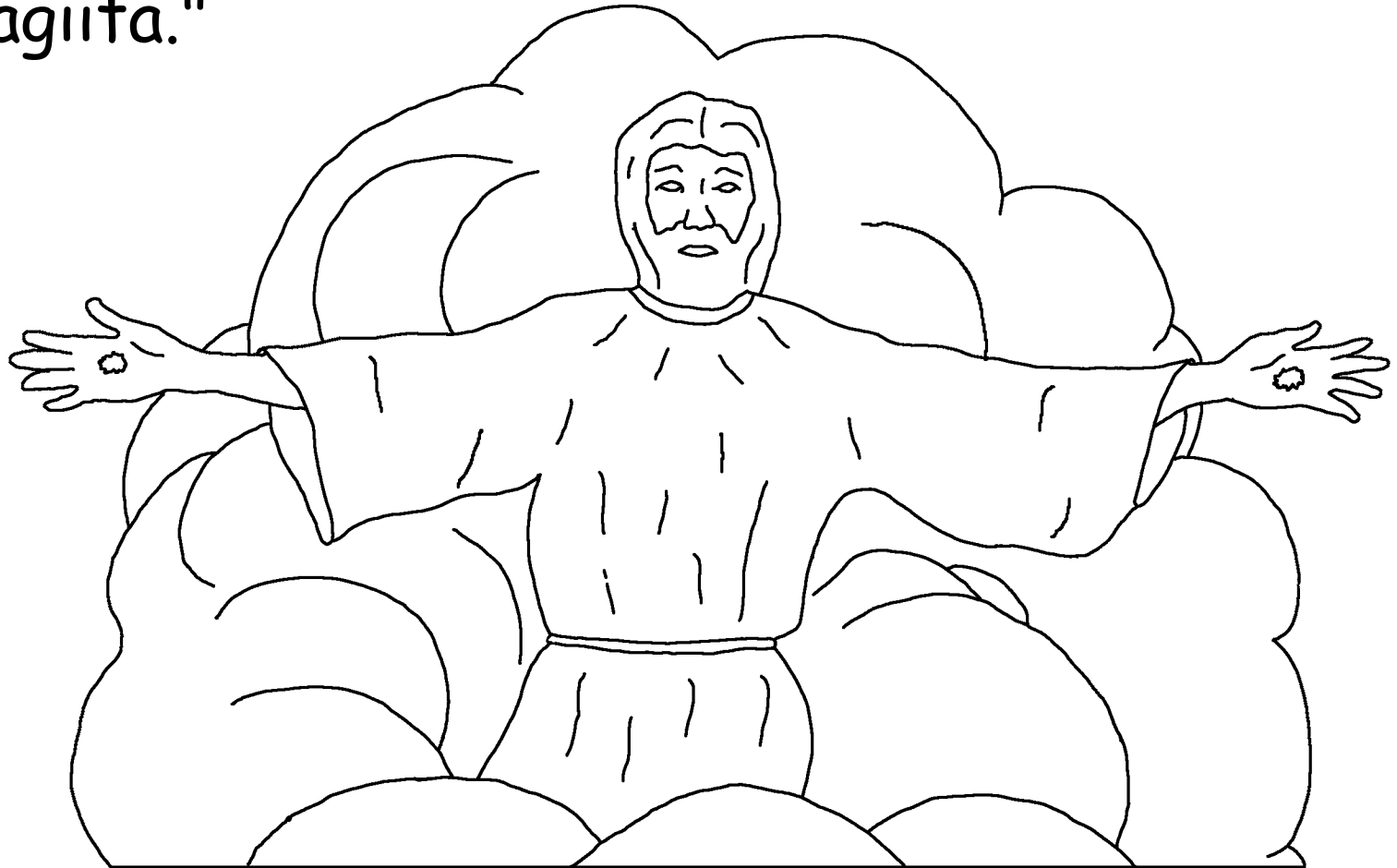

Anii Yohanes mee ko ikii ma Yesus yiba ena kenaa
bagee kemaata méé me inii méé wegee-wegee
segee naadi kaama ae-wae,

gaagaa segeekea.

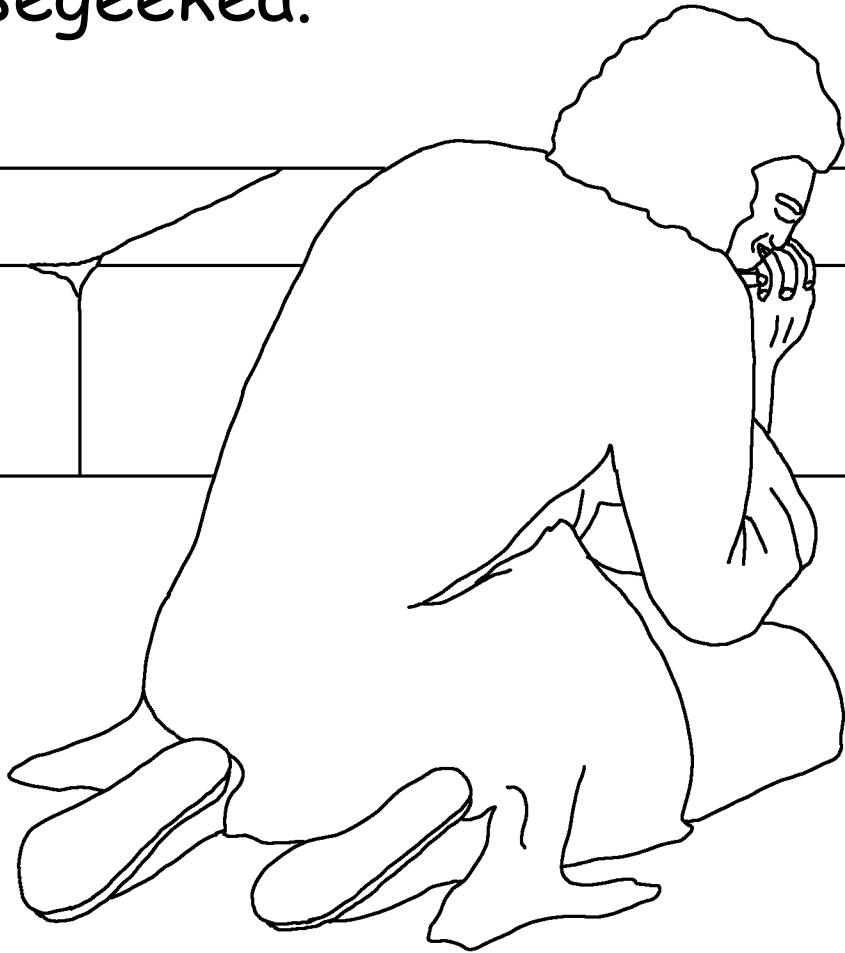

Kisee kiya inii paaya Yesus yiba epo enaataa ebo
toowoo see bagee yuwa mokoo méé kiyaata
kemaata inii Wa yiba epo enaataa makii

taa see kaa toogeekea.

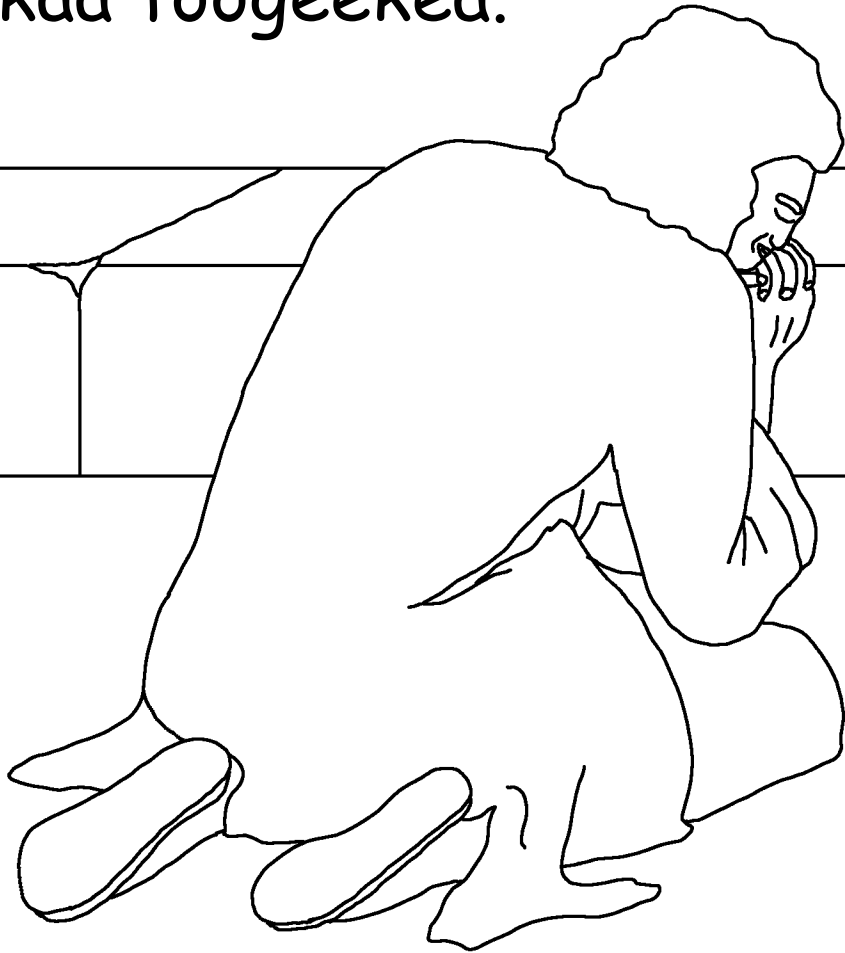

Ogatamee me aseta menaa ma, Yesus me daamaa yawegata menaa ma kuwa anii yaweganaa seta kuwa kaa méé me anii Patmos maga

okogoo to kaa nadogeamaamea.



Taka ena kisee ki Roh me anii pesee nakiyaata
kaama epoo to woodoo ebo animagaano yoo
komo ena agoo. Kiyoo ko Mée ena
keenda animaata tupi.

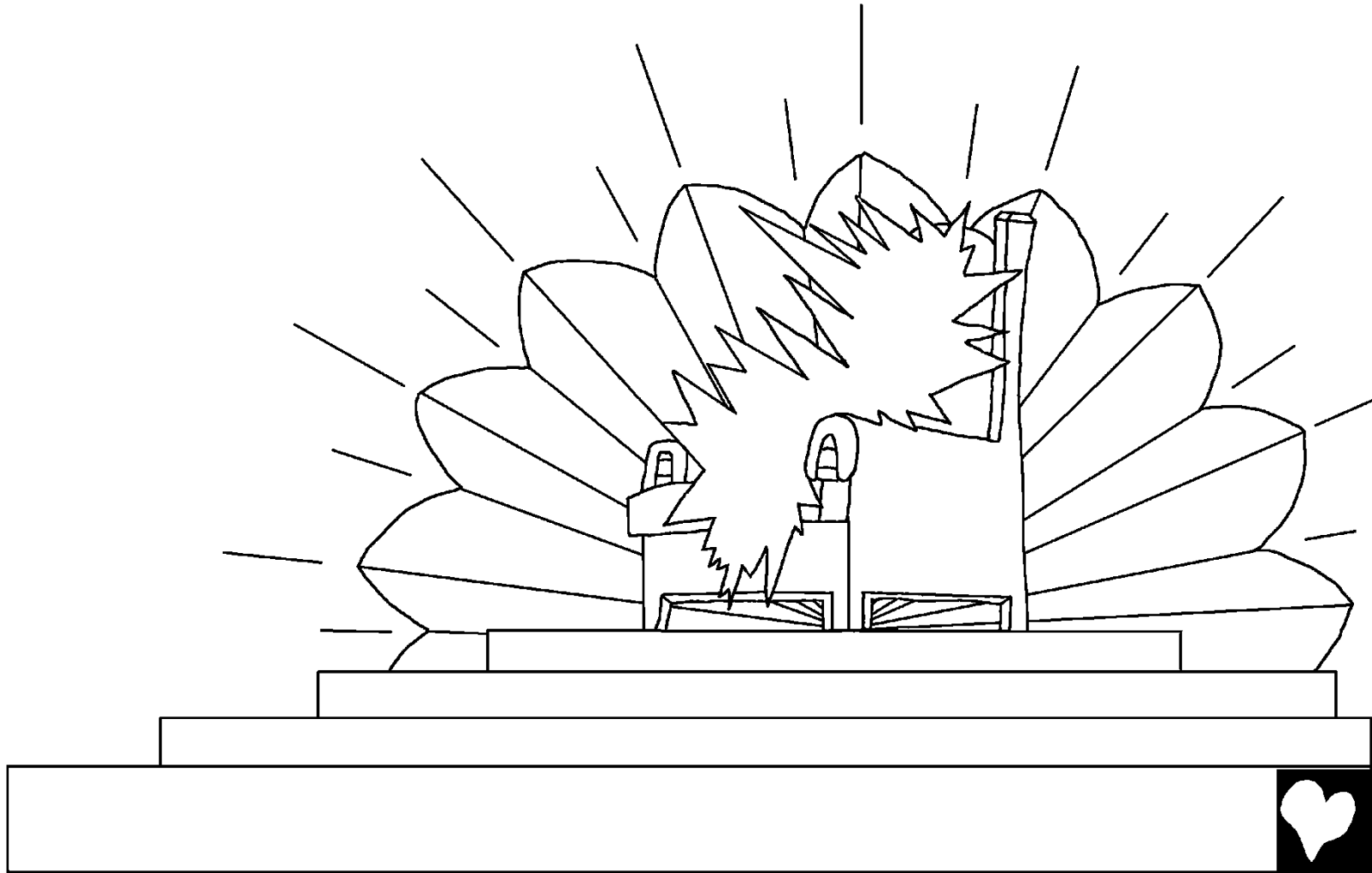

Kuwa kaboo da Wa me ogaataata yuwa kuwa uduma
me Waa yaapaagee see menaa kuwa anii yeetaa.

Kuwa ko epoo to wadoo topea yuwa
ma, magaa da kaa topea yuwa ma,
maga miyoo topea yuwa ma,
maakaa piku yiba topea yuwa ma,
kiyoo-kiyoo Wa me ogaataata
yuwa kuwa
uduma me
wegaano, . . .

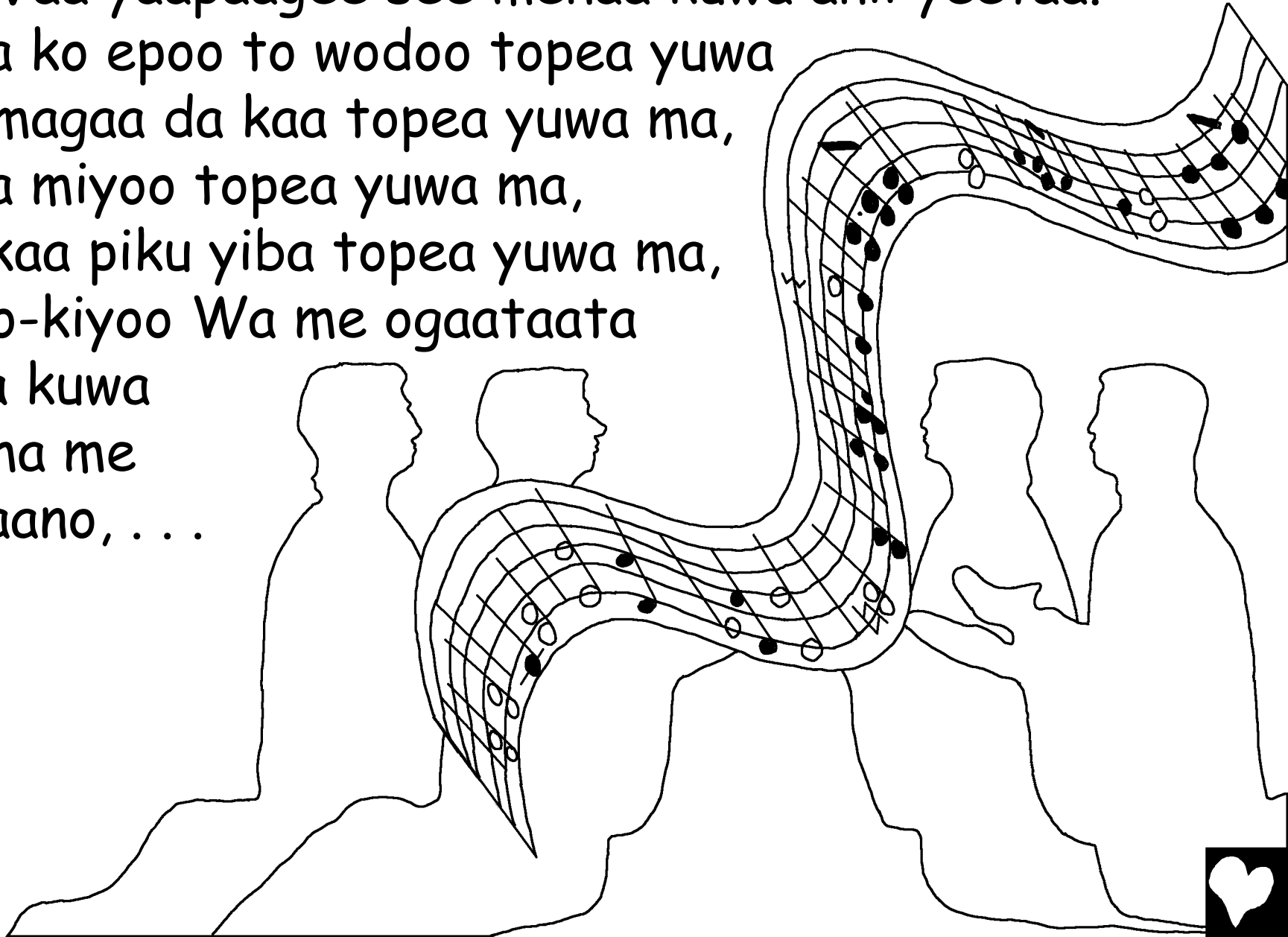

... "Ebo animagaano yoo animaata totaaki Mée mee ma, Domba Pooduu to mee ma Ekea niyaapaagee siweei. Ekea too ebo, Ekea too asii-sege, Ekea too pesee kiwoo, ebo toowoo, kisee too iminoo miya, iminoo miya" see menaa wegagea.

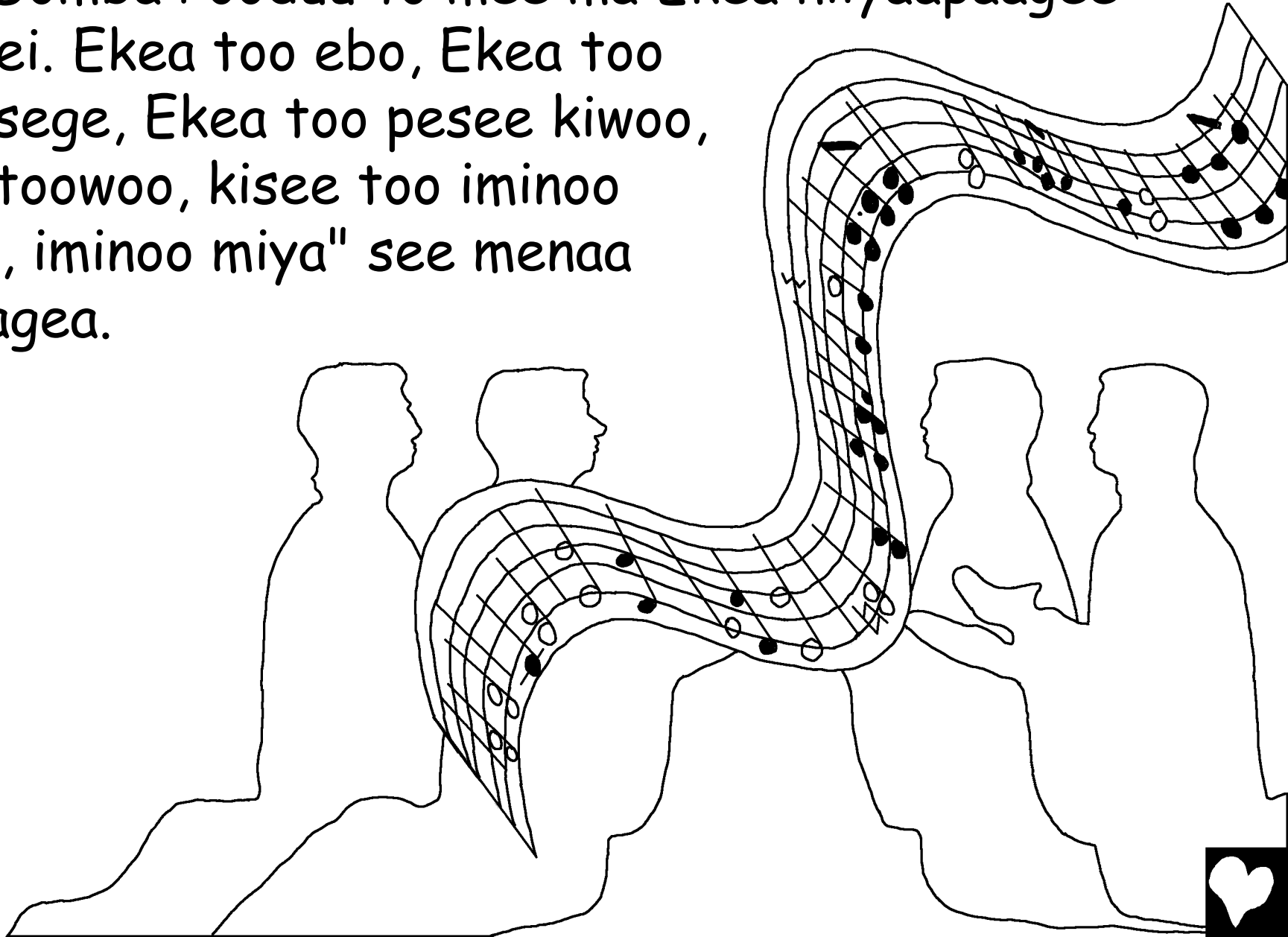

Bedaa anii deeyaa naaki daamaa wa too wigintaata
magaa mee, Yerusalem gipii see magaa mee epoo
to wadoo Ogatamee paagoo kaama esega, diino
esee ebo. Api ena paimme paagoo poono kaboo
disi ebo

agiyoo yuwa
maatagaa
siyaa see see
mee magaa mee
miya kisee
daamaa ipiipii
semaata esega.

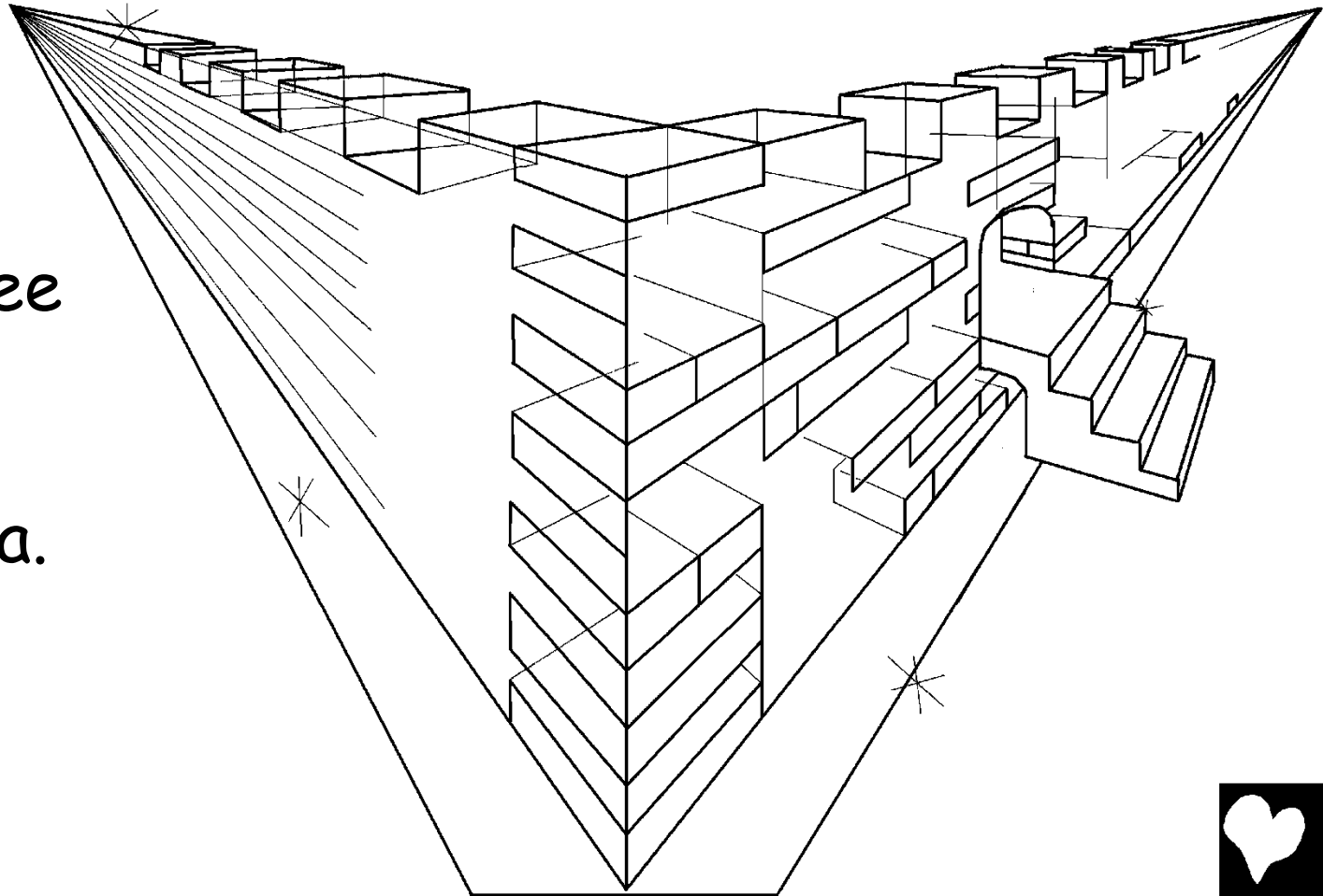

Kuwa kaboo da Wa me ebo animagaano yoo kaama
ebo mena wuu ena anii yeetaa, mee ko kisee: "Deede,
Ogatamee me totaa see yoo kiyoo ko eto méé paagoo
kega yoka Waa méé yupii toowoo taatagi. Okoo Wa
me bagee

yuwa
kaatagea,
bedaa Waa
okoo me Eboo
Ogatamee
kaatagi."

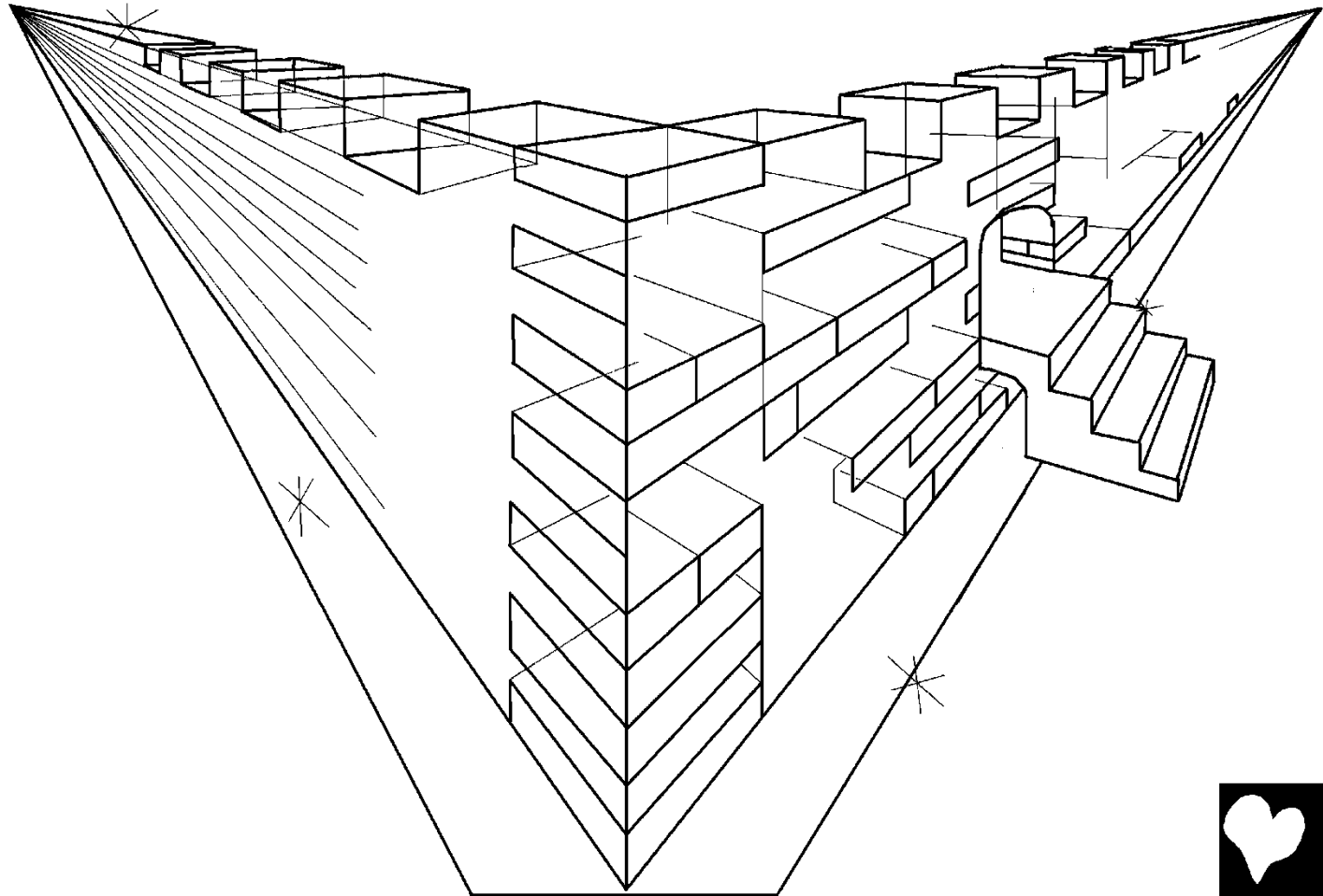

Kuwa kaboo da mee malaikat see mée to me mée
aya tuyaabuu siwoo siyaa uwoo kuwa nadeeyaagi.

Kuwa uwoo kuwa ko esee daamaa, awee, kristal
omaa deeyaa mokoo. Kuwa uwoo yuwa Ogatamee ma,
Domba Pooduu to ma Ekea me ebo animagaano
yoo kaama peetaaka.

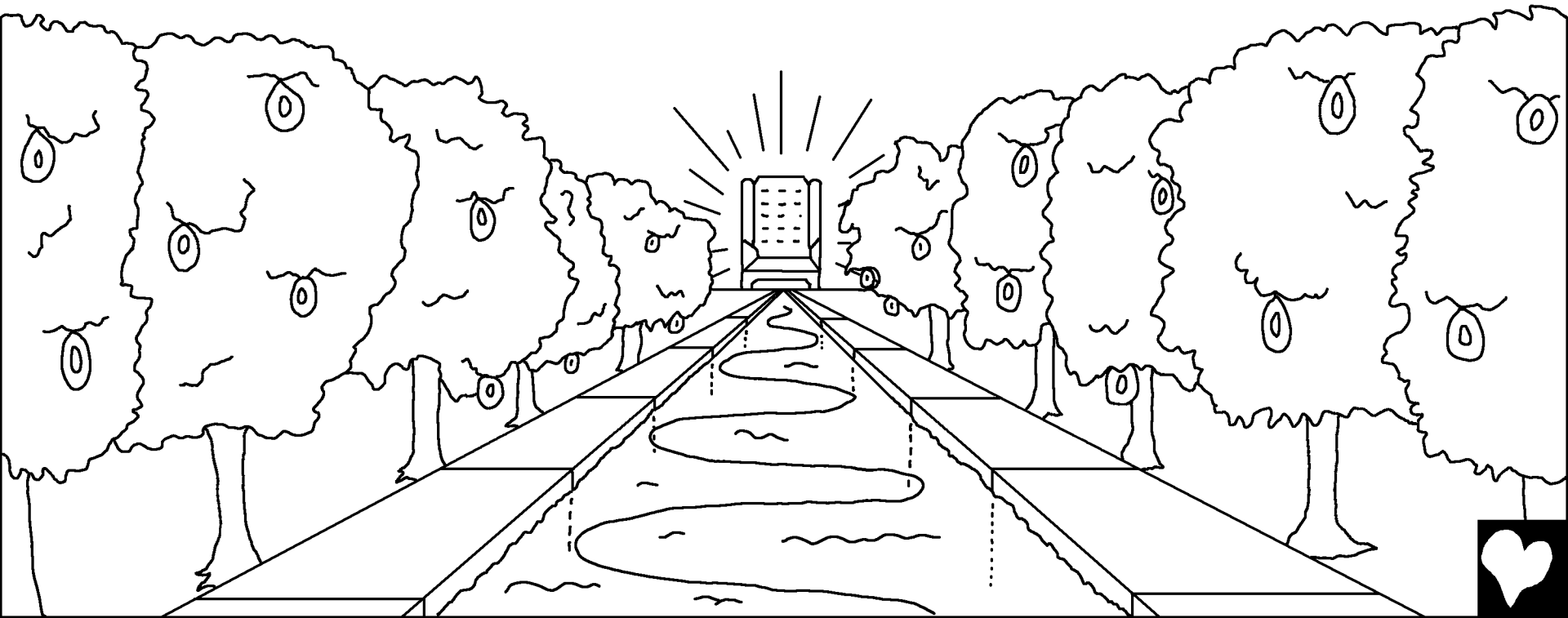

Mee kota magaa kaa Ogatamee me asii-sege siyaa
agiyoo agoo da wogaamaaga, Domba Pooduu to Waa
miya kisee peto agoo da mokoo. Kisee kemaata kenoo
to ma, agoo to ma kuwa mee magaa kaa ago
wogaamagaano gaano pedeo see taa.

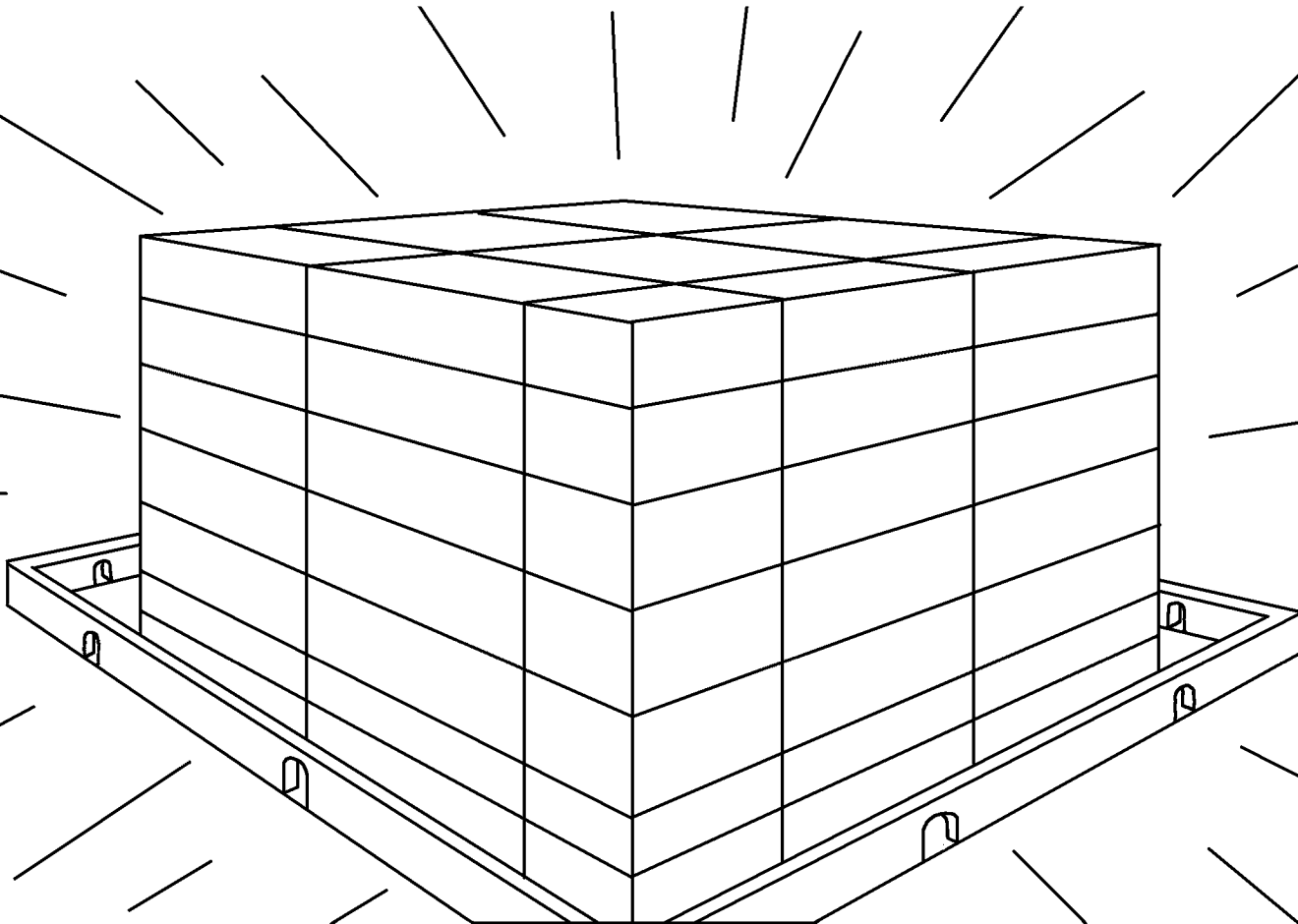

Kiya méé pedeo kiyaayaa agiyoo ena ma
kiyoo se seemaapa. Ogatamee me be kiyaa
agiyoo ukuwataa see bagee
ma, makapaa menaa
wegataa see bagee ma
kuwa miya kiyoo taa
kaata. Domba Pooduu
to Wa me tuyaabuu
siwoo taatagi bagee
ekaa yamaatagaa seta
kapogee yiba ekaa
agoo see bagee yuwa
too seemaatagea.

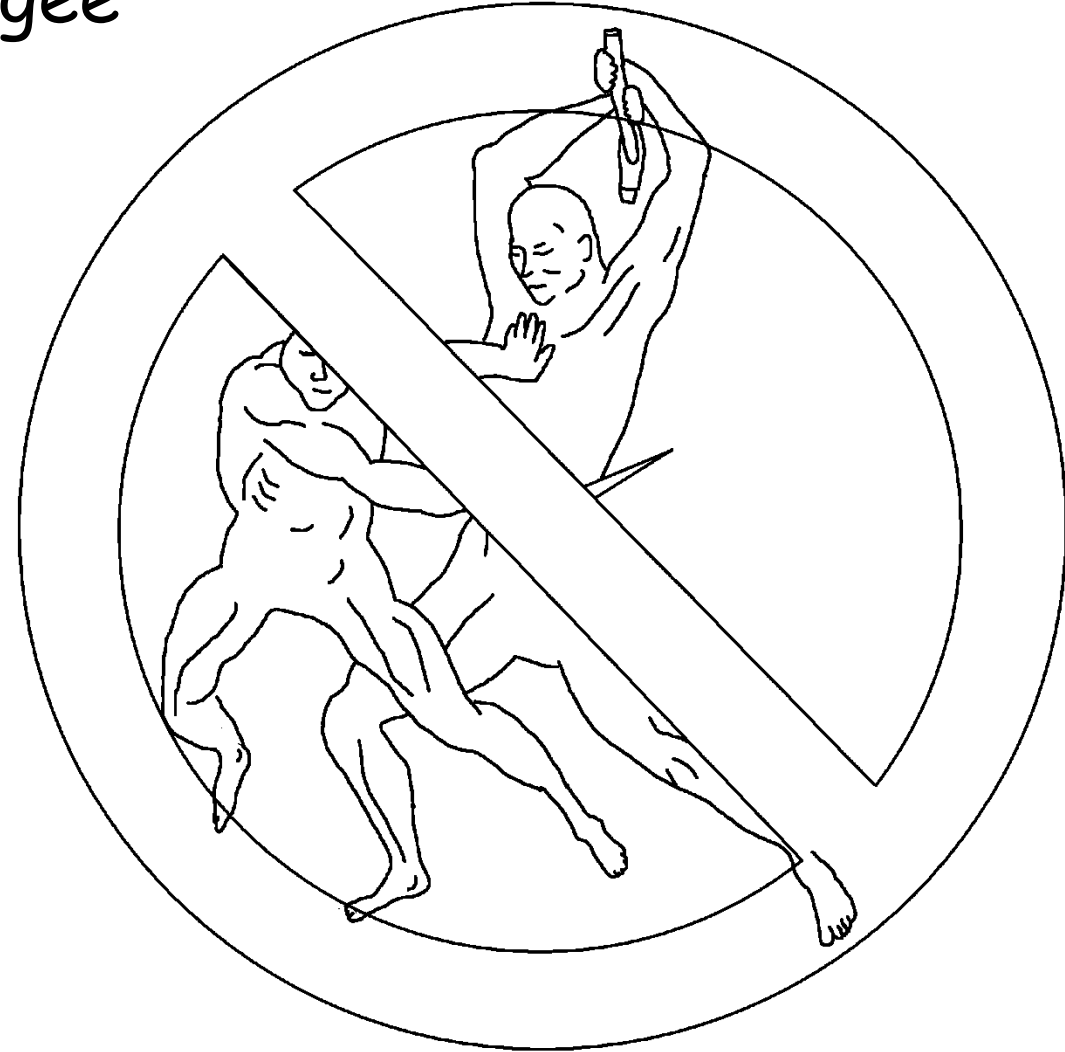

"Okoo me yegee uwoo yuwa kuwa uduma
Wa me yawonaapeasiitagi. Mee kaama
asii bogaano miya taa, yege ma, yii-yii
ma kuwa miya taa, boodi miya taa.
Kisee ukuwawoo seta yuwa kuwa
uduma eto taa keepeasega"
see wegagi.



Mee magaa kaa Ogatamee me pedeo ayaa
yadootaayaa agiyoo ena ma taa kaata. Ogatamee ma,
Domba Pooduu to ma Ekea me ebo animagaano yoo
kiyoo agoo kaata. Wa me agiyoo daamaa
yaokagee see bagee
yuwa me Waa ebo
ekee, yaapaagee
siwoo taatagea.



Okoo me Wa me ebeyumaa da diitagea.
Wa ekaa da okoo me etaguu to kaa
yaebeamagaatagi.



Kuwa kaboo da anii deeyaa naaki boota bagee
yuwa, ebo, peedi uduma ebo animagaano yoo ikigii to
kaa yiinaageeta topea. Kapoge yuwa miya topa. Kuwa
kapogee yuwa kabataagea. Kabataata kaama apanaa
kapogee ena miya kabataagea, mee ko
Ogatamee me tuyaabuu siwoo
taatagi bagee yuwa ekaa
yamaatagaa seta
kapogee mee.

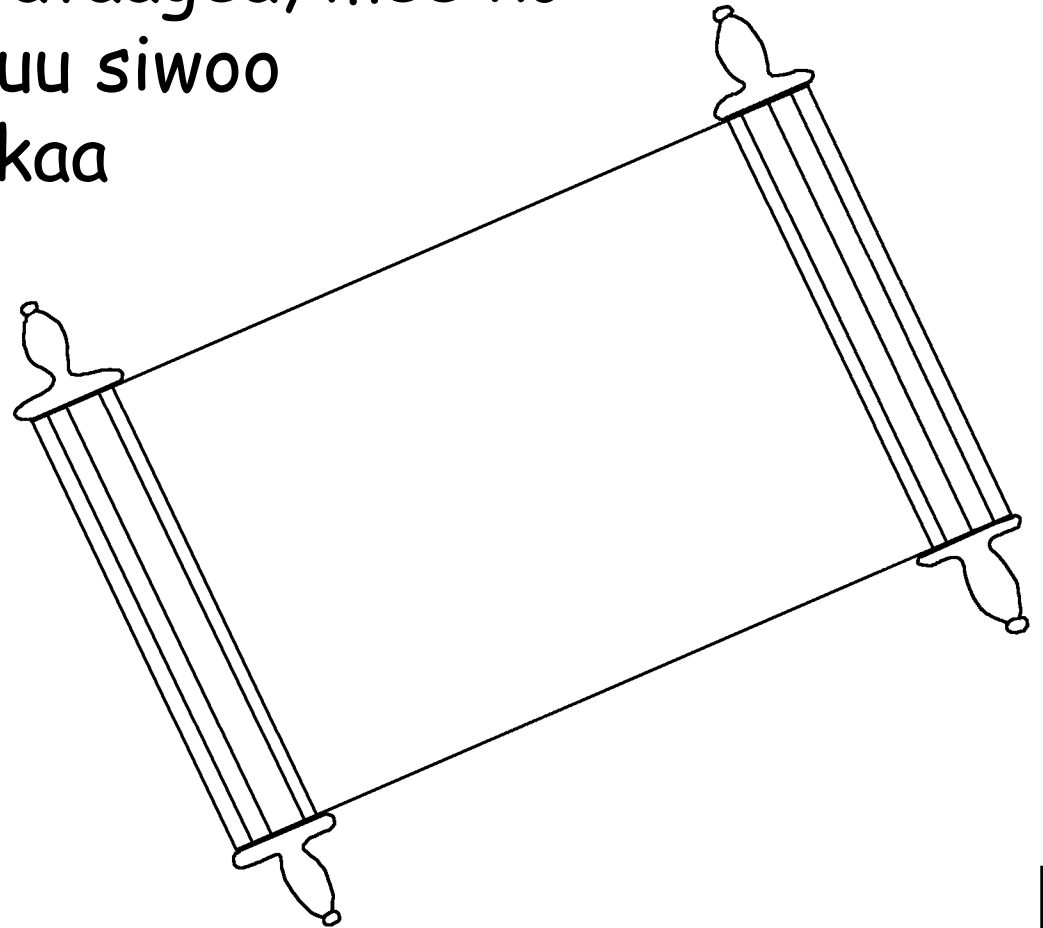

Boota bagee yuwa okoo me ukuwagee seta yuwa kuwa kapogee yiba yaebeamata doodoo wigintagaakea. Oगतamee me tuyaabuu siwoo taatagi bagee okoo ekaa yuwa yamaatagaa seta kapogee yiba ekaa taa see bagee yuwa kuwa biyaa piku yiba tamekomegea, see kuwa anii deepa.

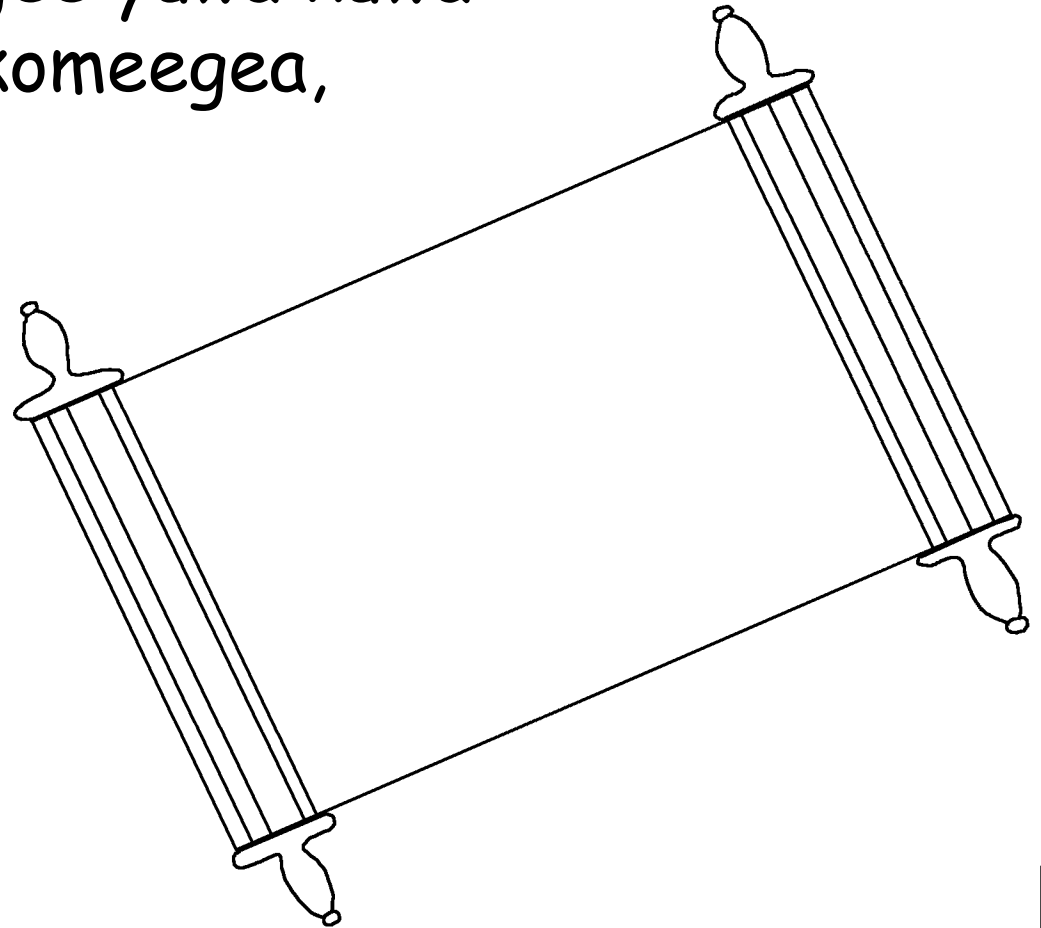

Roh mee ma, Domba Pooduu to Wa me goeano
see apii to mee ma kuwa me "Meei" see
wegagea. Bedaa mee menaa yeeyaa bagee kuwa
miya "Meei" see kuwa asiino daamaa.

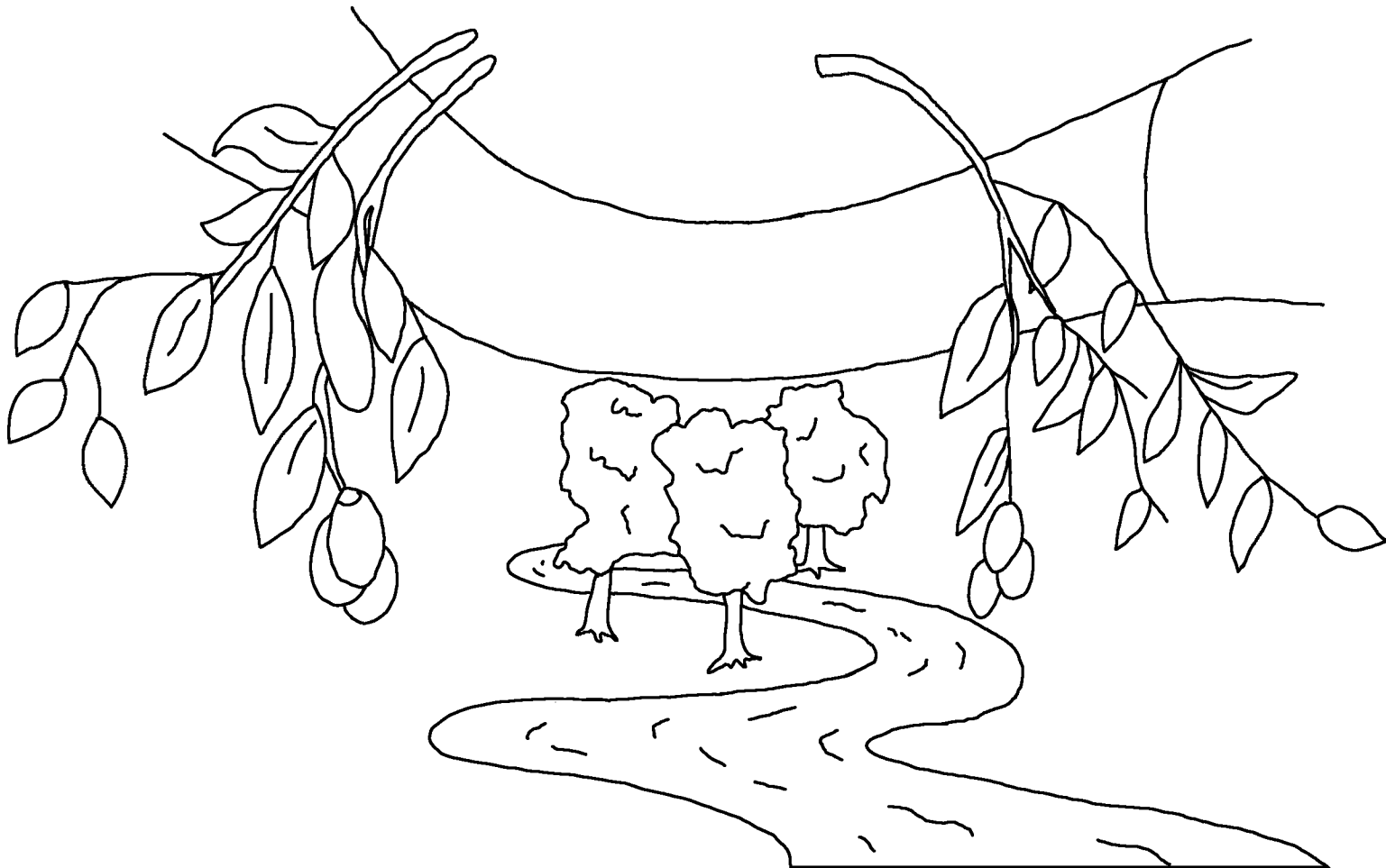

Uwo naadi kiyaa bagee uduma meei. Uwo
naano ede kiyaa bagee yuwa uduma
kuwa méé aya tuyaabuu siwoo siyaa uwoo
kuwa aii kisee naano ke meei.



Ogatamee me
magaa da kaa bagee yuwa esee epa
kemaata Wa me ena too too Yogaa méé
manta. Waa mikee gaayaa bagee yuwa
uduma se pedeo keta iminoo miya,
iminoo miya kisee too toowoo
segeesi naadi méé
manta.



Roma 3:23 inii uduma pedeo agiyoo ukuwagee seta bagee yuwa kemaata inii uduma sikii taa. Ogatamee paagoo asii-sege siyaa agiyoo yuwa méé kaa daamaa yaekeata yuwa kuwa taa kedaa seta kaama inii kisee totaakea.

Roma 6:23 Pedeo dimii gaawoo, pedeo agiyoo ukuwawoo setaa to mokoo da mee ko méé boota kaama wigintaayaa. Kiya Ogatamee me aii méé yaekeata agiyoo mee gaayu ko inii epoo Méé Tuhan Kristus Yesus ma dimi aagadi-maagadi naadi kisee too iminoo miya, iminoo miya toogee siwoo siyaa kuwa.

Ibrani 9:27 Ogatamee me gaata dimii mee ko kisee: méé tomaa yuwa okoo méé gakata kaagaa ena too too booyaa. Kiyoo kaama okoo kaa daamaa, pedeo see kuwa yawegamaata kaama okoo pe-wigintaayaa.



Epesus 2:8,9 Mikee, ikii daba kidaagimaa peeyaata totaakea mee ko Ogatamee Wa me ikii aii kisee kiepa see dimii mee kaa too, ikii Kristus mikee nao see gaata kemaata Wa me kisee daamaa kikiyaata. Ikii ekaato daba daagimaa peeyaano iyo. Ogatamee Wa me too ikii aii kisee kiepa kaa kiukuwata agiyoo da. Ikii me daamaa ukuwata agiyoo kuwa kaa se. Kuwa me kemaata méé ena me ebo poga-poga see dimii mee iyo.

Roma 10:9 Kisee ikii me ebee to kaa "Yesus mee ko Tuhan yoka" see wegataa, bedaa dimi yiba 'Yesus mee boota kaama Ogatamee me mikee aya andoo peeyaata ii' see kuwa miya gaataa, kisee ukuwayu ko ikii daba daagimaa pootagea.



Roma 10:10 Yesus me menaa kuwa dimi yiba awimaayu naadi kaama Oगतamee me mée sikii kiyaayaa, bedaa ebee to kaa Yesus mikee nao see wegamaayu naadi kaama mée daba daagimaa peeyaa.

Yohanes 3:16,17 Oगतamee me magaa da kaa bagee yuwa esee epa kemaata Wa me ena too too Yogaa mée manta. Waa mikee gaayaa bagee yuwa uduma se pedeo keta iminoo miya, iminoo miya kisee too toowoo segeesi naadi mée manta. Oगतamee Wa me Yogaa magaa da kaa bagee paagoo isiyaata mee ko mée tomaa pedeo kiyaabuu taano see naadi se kiya Wa me Yogaa me mée tomaa daba daagimaa peeyaabuusi naadi isiyaata.



1 Yohanes 5:11-13 Mikee menaa kuwa ko kisee: Ogatamee me inii iminoo miya, iminoo miya toowoo taano bagee méé kiyaata. Wayoopaa ma inii dimi aagadi-maagadi naadi kaama kisee too toowoo siyaa. Ogatamee Yoopaa mee dimi yiba agoo see bagee kuwa iminoo miya, iminoo miya toowoo siyaa. Ogatamee Yoopaa dimi yiba taa see bagee kuwa ko taa, kisee too se toowoo siyaa. Ikii me Ogatamee Yoopaa mikee nao, Waa ko ekaa yago Méé yoka see gaataa see bagee kuwa ikii kisee too iminoo miya, iminoo miya toowoo taatagea ii see kuwa ikii ipi kesea naadi anii kuwa menaa kiebeaga.



Yohanes 14; 2 Korintus 5; Wahyu. 4, 21, 22

Storyline by: Edward D. Hughes

Illustrated by: Lazarus
and Alastair Paterson

Adapted by: Sarah S.

Ayu Bible (auu) © (Active), Wycliffe Bible Translators,
Inc. All rights reserved.

<https://www.bible.com/en-GB/bible/2547/MAT.1>

©2026 Bible for Children, Inc.

www.M1914.org

www.bibleforchildren.org

