

www.BibleForChildren.org

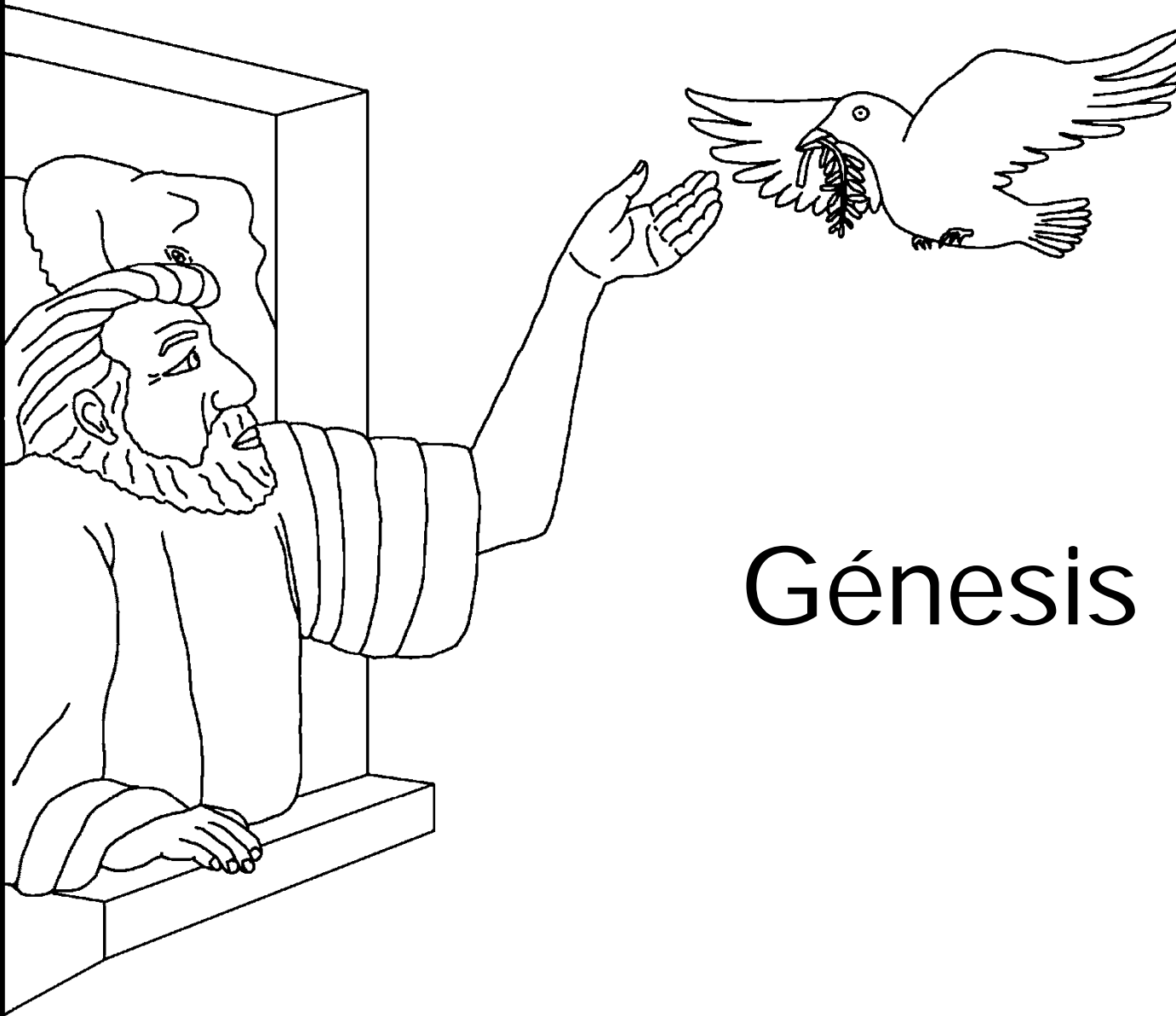

Génesis 6



I bin jalu' je xtxolbile'j te yi
mbi cu'n banak Noé.

Chumbalaj nin i' banak, na
nin xom i' te ca'wl Ryos. Ntin
cu'n i' jal c'ulutxumil swutz Ryos.
Chum balaj nintzun banak

Noé swutz Ryos, ma
yi e' mas
wunak chin
juntlen nin cyetz
cyajtza'kl.



E' len cu'n mal nak. Itzun yi tilol Ryos yi mbi
cunin na chitzan wunak tan banle'n, nintzun
ben tlol tetz Noé: "Ja wi't bixe' wa'n tan
chisotzaje'n cyakil wunak, na ntin na
chibiy quib squibil quib. Cha'stzun te
chicopon insotzal tuml cyakil jilwutz
txuc tu cyakil e'chk
takle'n yi at
wuxtx'otx'."



"Ma a'xa'tz Noé, banaj jun xo'mbil wi a'. Ba'n
xcon jun jilwutz tze' awa'n yi at k'olil. Nin
banaj e'chk cuart tul yi jun xo'mbila'tz. Ma
yil bnix, tajwe'n tzanojsaj yi xchubil tze'
tan jun jilwutz k'ol yi na bi'aj brea,
bantz quil tz'oc a' tul. Okquen yi k'ol
awa'n tc'u'l, nin
ncha'tz solte'j
tan qui

toque'n
a' tul."

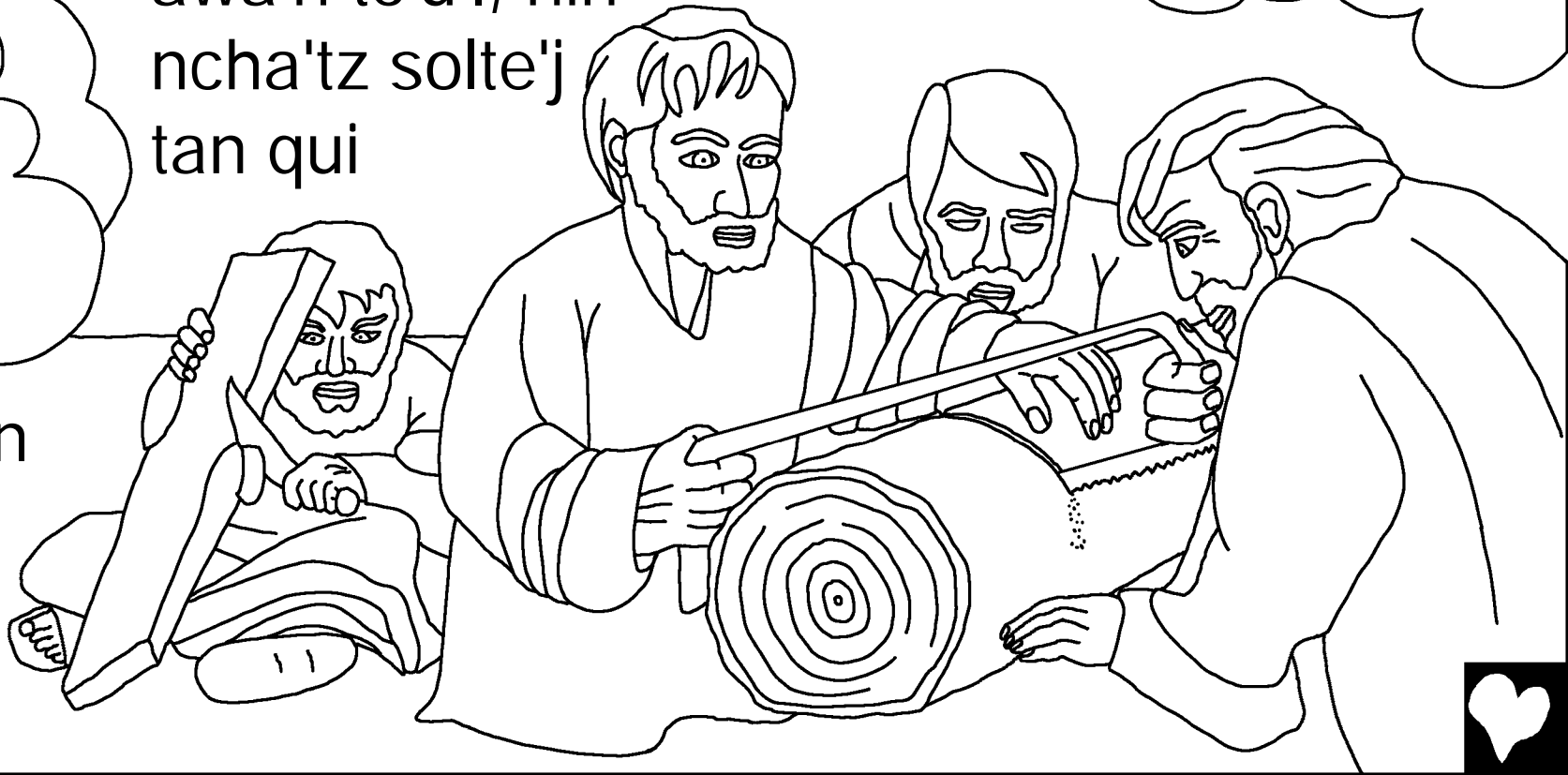

Ej nin je tzawuleje'j:
Yi xkinewe'n, jun cient
tu junak o'laj metr
tzawulej.

Ma yi wutz,

junak cob
metr tu
ni'c tzawulej.
Ej nin oxlaj
metr tu ni'c
tzawulej yi
wutz tkan.

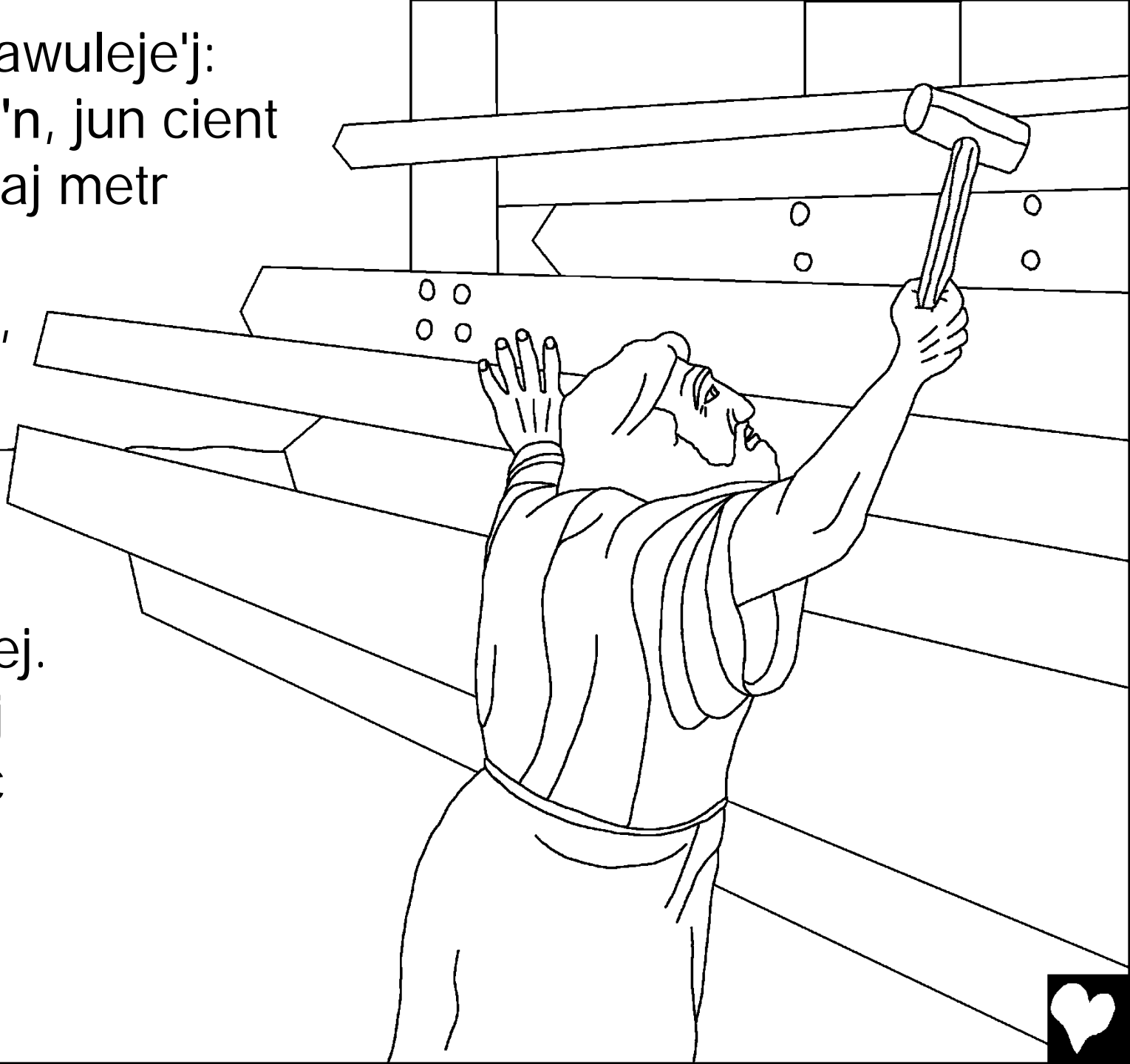

"Porro tajwe'n cxo'c tan
xchamle'n iwa', nin chiwa'
yi e' txuc. Ej nin tajwe'n tan
acolol tul barc bantz quil
xquimwok tan we'j," stzun
Ryos bantz tetz Noé.



Ncha'tz na waj yil cho'c jujun Imuj txuc tzite'j le barc,
jun mam nin jun tij. Na na waj yil chiclax, chi sbajok
tzite'j itetz.

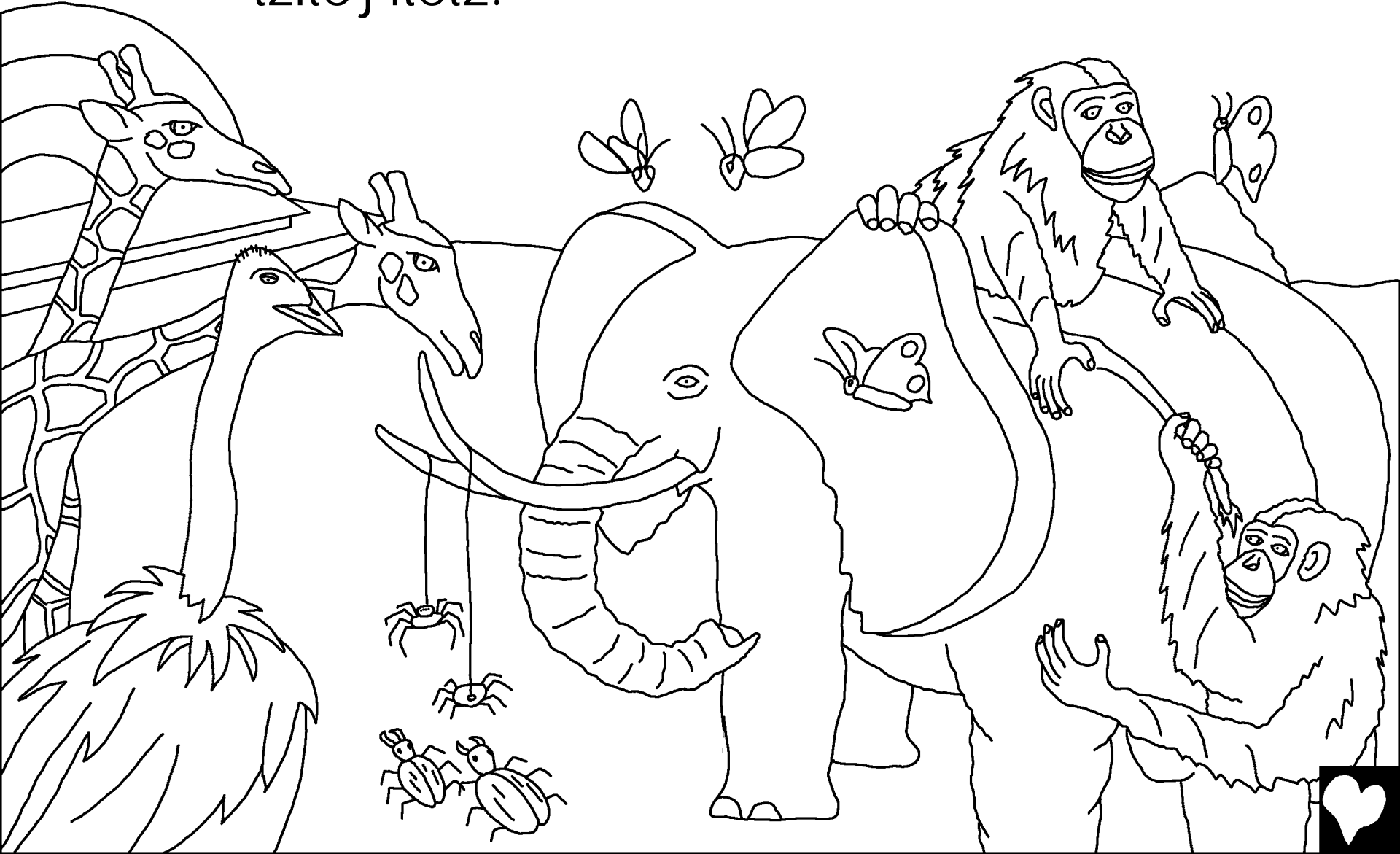

Ma yi e' txuc yi nk'e'tz xan, yi at cuj tan
baje'n ita'n, tajwe'n tan cyoque'n
le barc tzite'j, juk chak Imuj te
jujun jilwutz txuca'tz, ma yi
e' txuc yi xan tan baje'n ita'n,
cho'ken jun ntzi' Imuj
awa'n te jujun jilwutz.



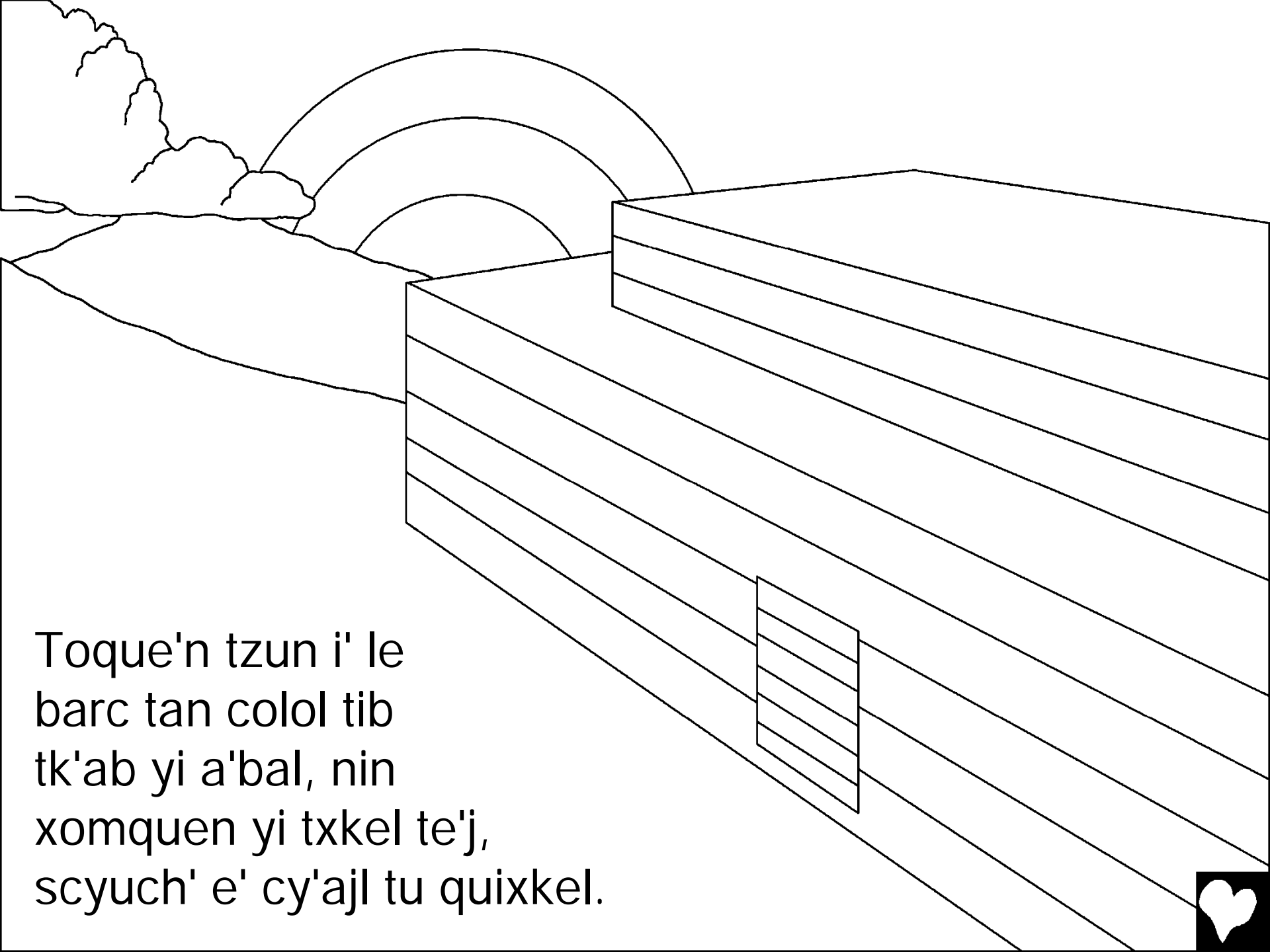

Toque'n tzun i' le
barc tan colol tib
tk'ab yi a'bal, nin
xomquen yi txkel te'j,
scyuch' e' cy'ajl tu quixkel.

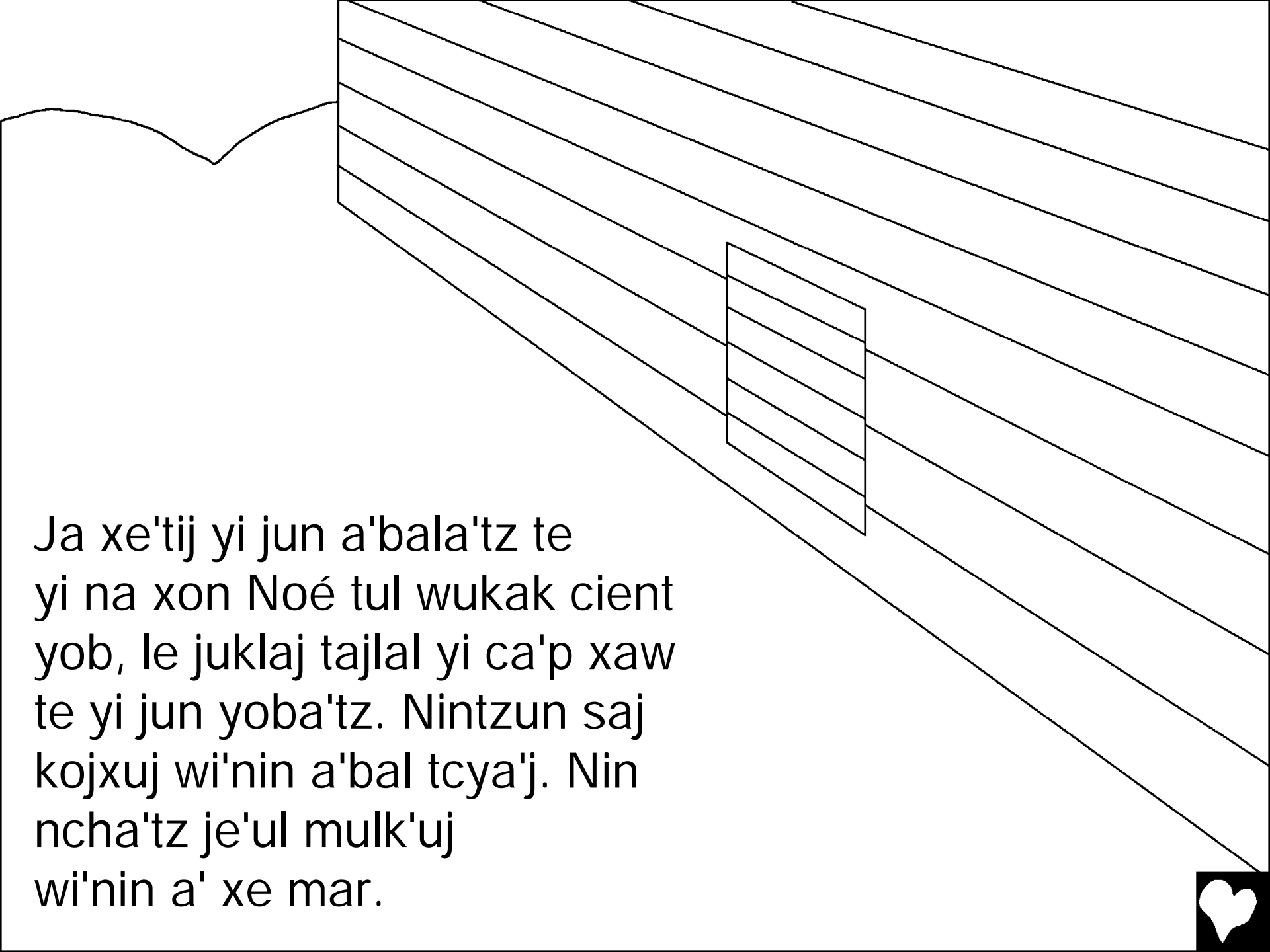

A line drawing of a building with a window. The building is represented by several parallel lines sloping downwards from left to right. A rectangular window with horizontal lines is positioned on the side of the building. Above the building, there is a wavy line that resembles a roof or a landscape feature.

Ja xe'tij yi jun a'bala'tz te
yi na xon Noé tul wukak cient
yob, le juklaj tajlal yi ca'p xaw
te yi jun yoba'tz. Nintzun saj
kojxuj wi'nin a'bal tcya'j. Nin
ncha'tz je'ul mulk'uj
wi'nin a' xe mar.



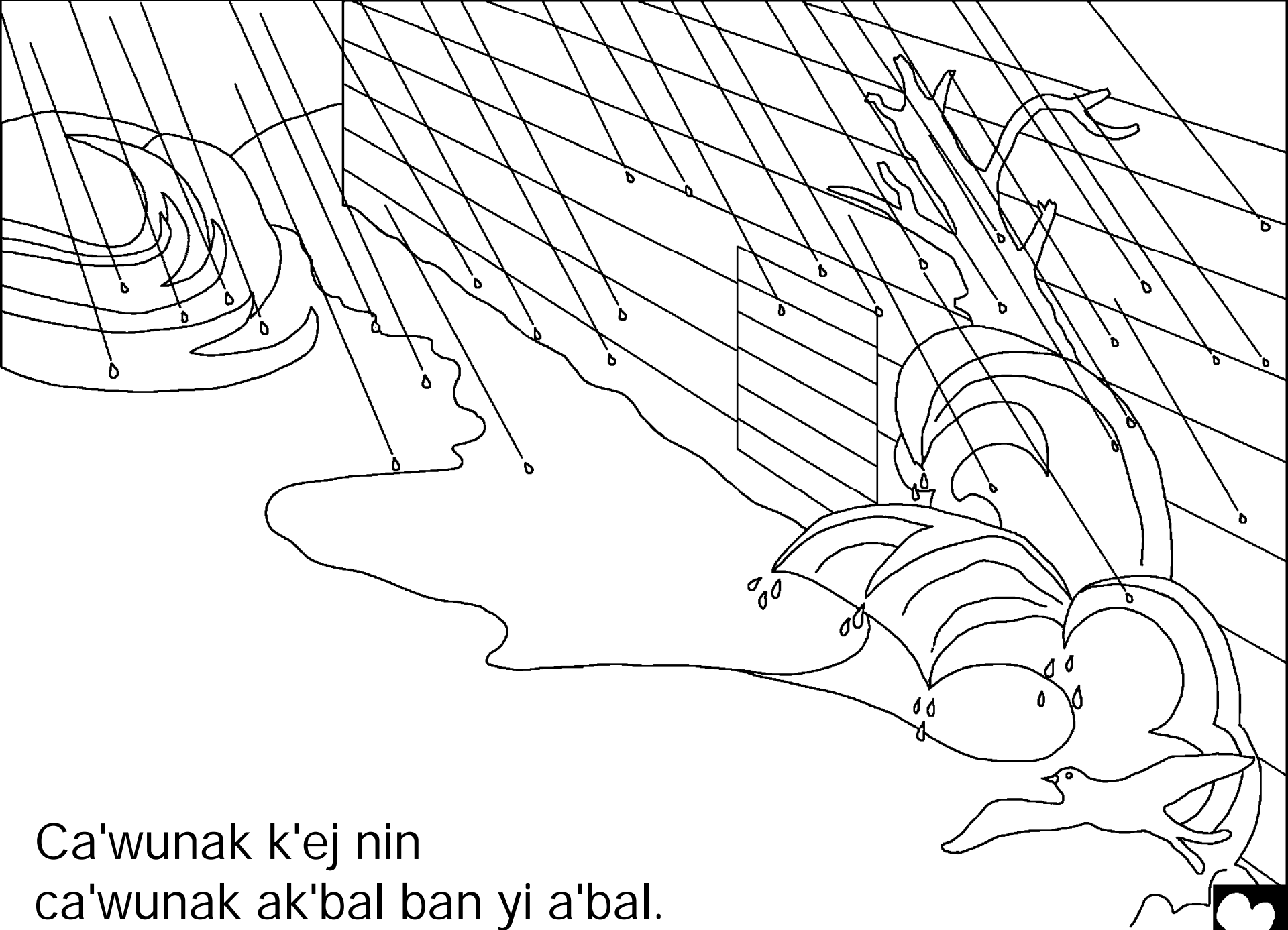

Ca'wunak k'ej nin
ca'wunak ak'bal ban yi a'bal.



Ch'uye'n nin ban yi a'
nin palij yi barc ta'n.



Yi xch'uye'n yi a' ja xcy'e' tan jople'n yi e'chk wutz yi chin wutz tkan nin. Cyakil yi wunaka'tz nin cyakil txuca'tz e' baj quim len.



Poro Noé scyuch' yi e' txuc yi ate'
tc'u'l yi barc, quinin e' el te c'u'l Ryos.
Cha'stzun te xtxumul i' tan saje'n jun
cyek'ek' tan tajse'n cu'n yi a'.

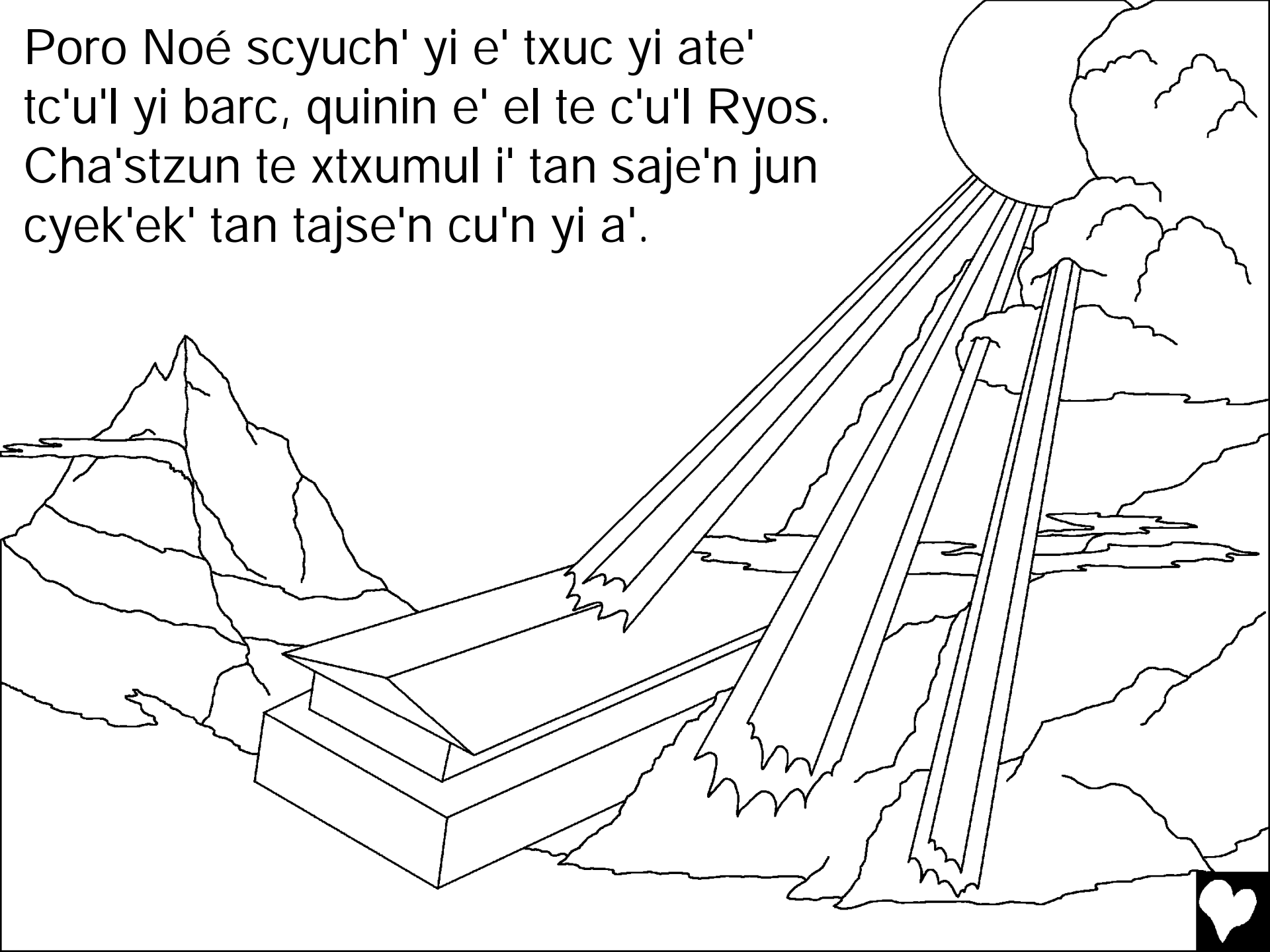

Äch'iwal tzun Noé ca'wunakt k'ej. Kalena's tzun
je'n jakol yi wentanu'il yi barc. Yi

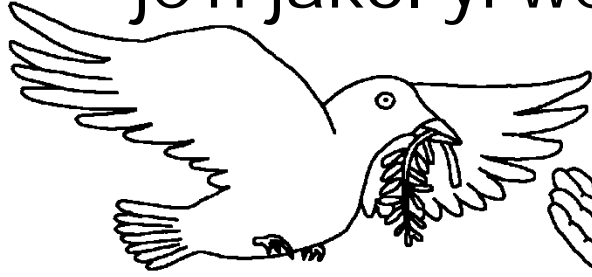

sken eltzaj yi joj,
ncha'tz nin eltzaj stzakpul
Noé jun slu'k tan tele'n
txxum i' tetz yi ko sken
skej yiwuxtx'otx'.

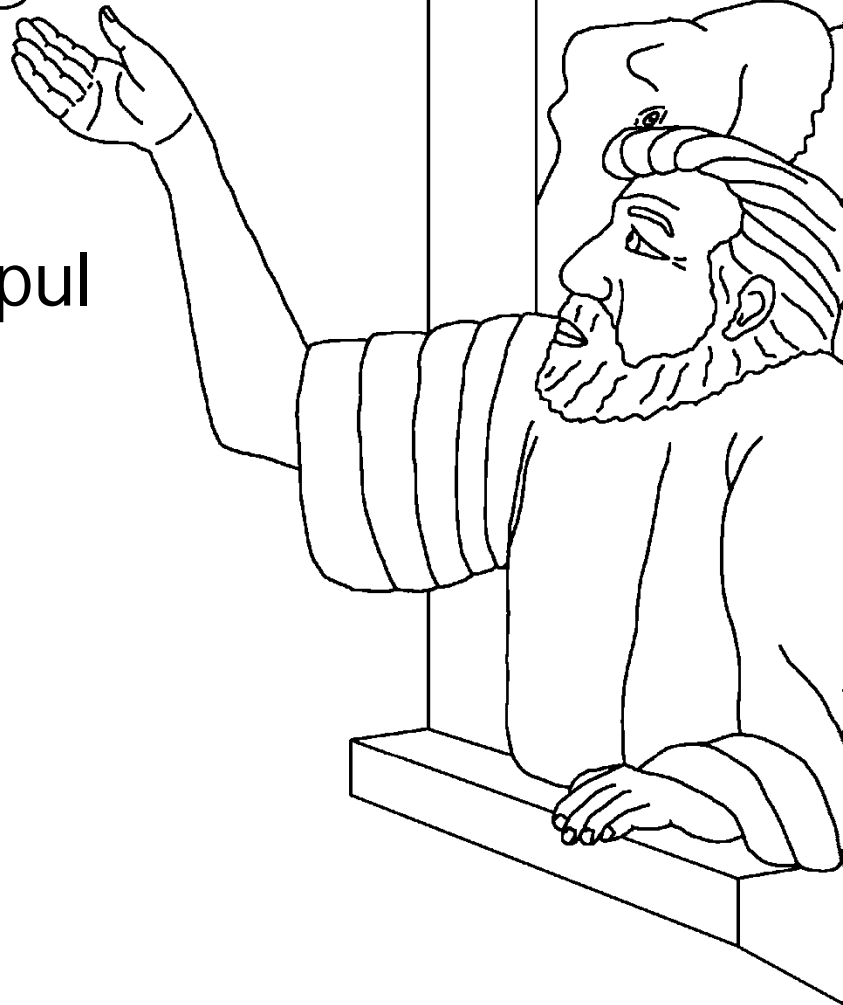

Itzun le junak juk tajlal te yi ca'p xaw teri yoba'tz,
nternin chin skejt ban yi wuxtx'otx'. Nintzun tal Kataj
Ryos tetz Noé: "Ba'n cxe'lwok le barc jalu'.

Ba'n tz'el awuxkel
nin e' anitxa'
scyuch' e' awulib."



Toque'n tzun Noé tan wekle'n cobox
c'ub tetz patbil
chitx'ixwatz. Yi
bnixe'n nintzun
e' baj saj stz'amol Noé
jujun scyeri e' txuc yi
ba'n tetz chitx'ixwatz.
Ej nin pat Noé yi e'
txuca'tz tetz toy
tetz Ryos.

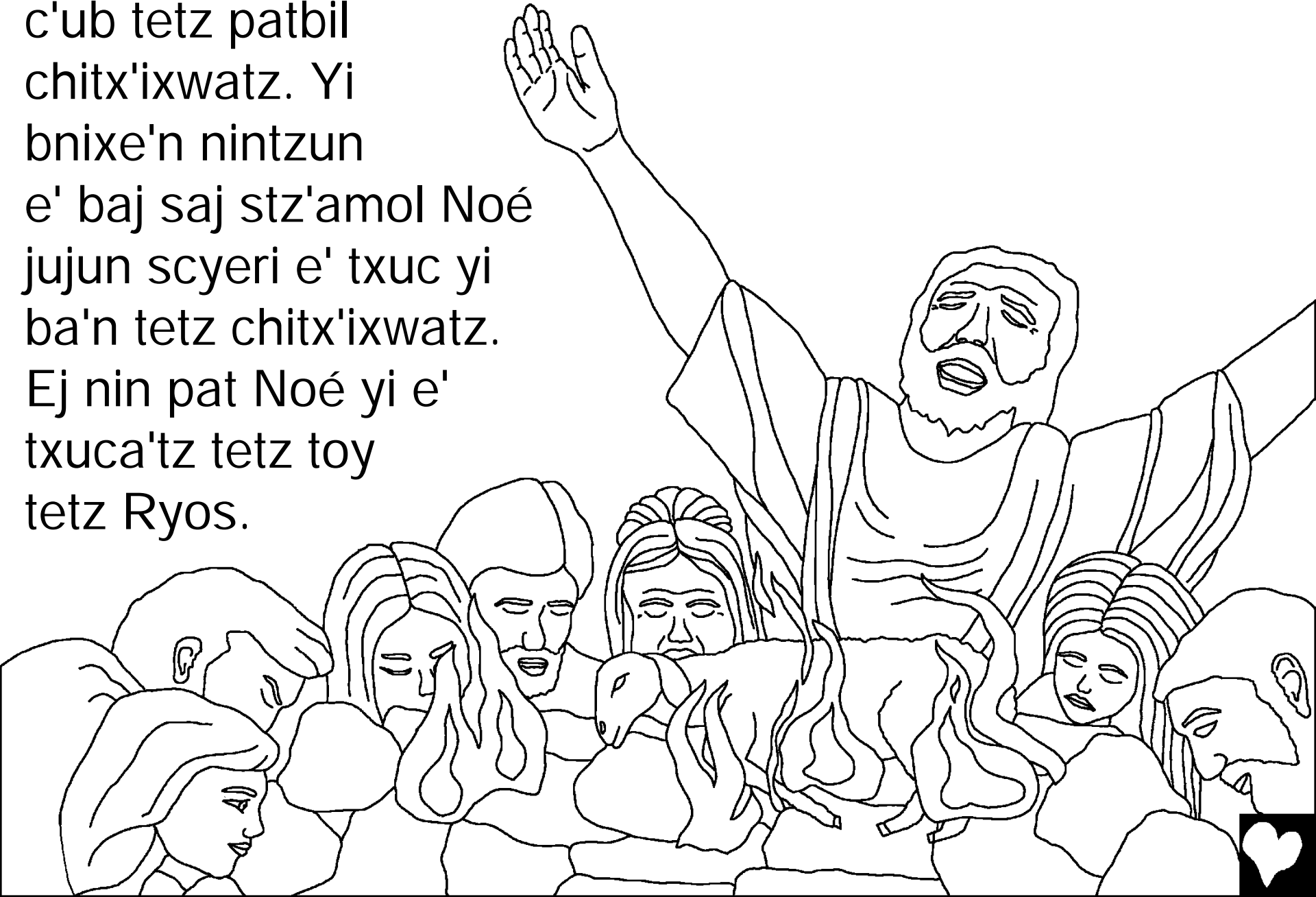

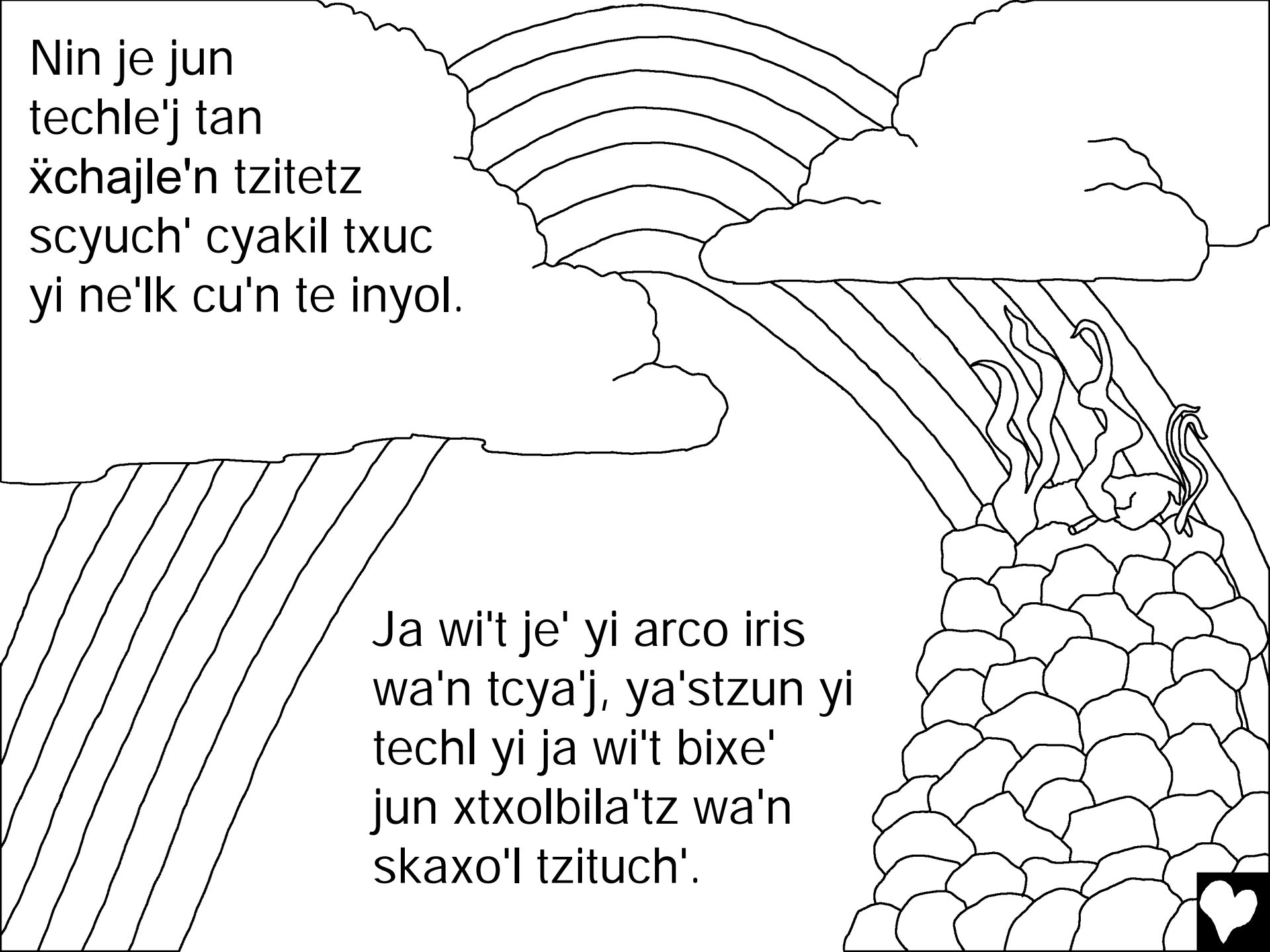

Nin je jun
techle'j tan
xchajle'n tzitetz
scyuch' cyakil txuc
yi ne'lk cu'n te inyol.

Ja wi't je' yi arco iris
wa'n tcya'j, ya'stzun yi
techl yi ja wi't bixe'
jun xtxolbila'tz wa'n
skaxo'l tzituch'.



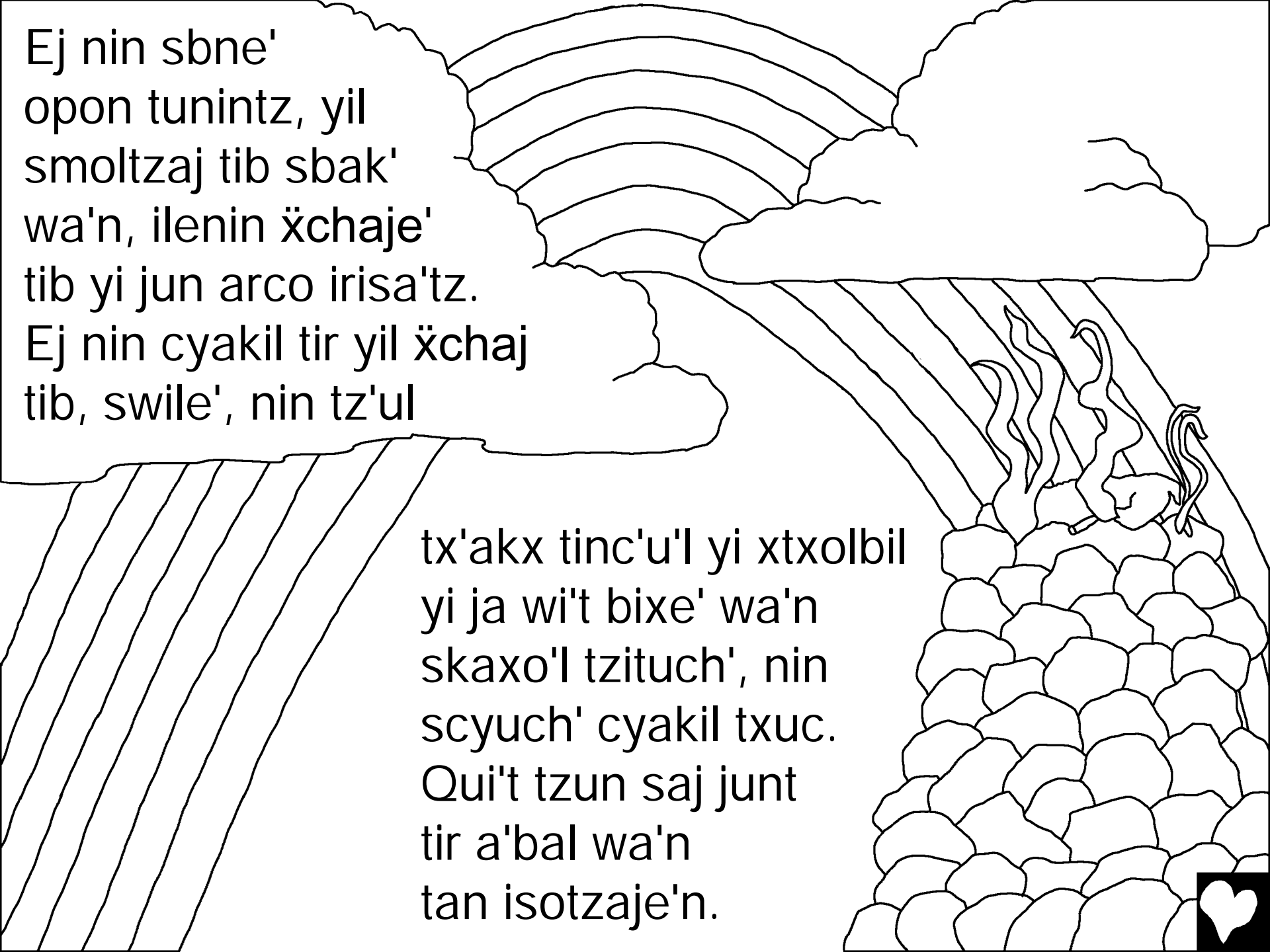

Ej nin sbne'
opon tunintz, yil
smoltzaj tib sbak'
wa'n, ilenin xchaje'
tib yi jun arco irisa'tz.

Ej nin cyakil tir yil xchaj
tib, swile', nin tz'ul

tx'akx tinc'u'l yi xtxolbil
yi ja wi't bixe' wa'n
skaxo'l tzituch', nin
scyuch' cyakil txuc.
Qui't tzun saj junt
tir a'bal wa'n
tan isotzaje'n.



Ej nin ncha'tz tak' Ryos
banl tib Noé scyuch' e' nitxajil tan
yi yole'j: "Sjalok wi'nin initxa' bantz
jale'n wi'nin wunak bene'n tzi'n
wuxtx'otx'.

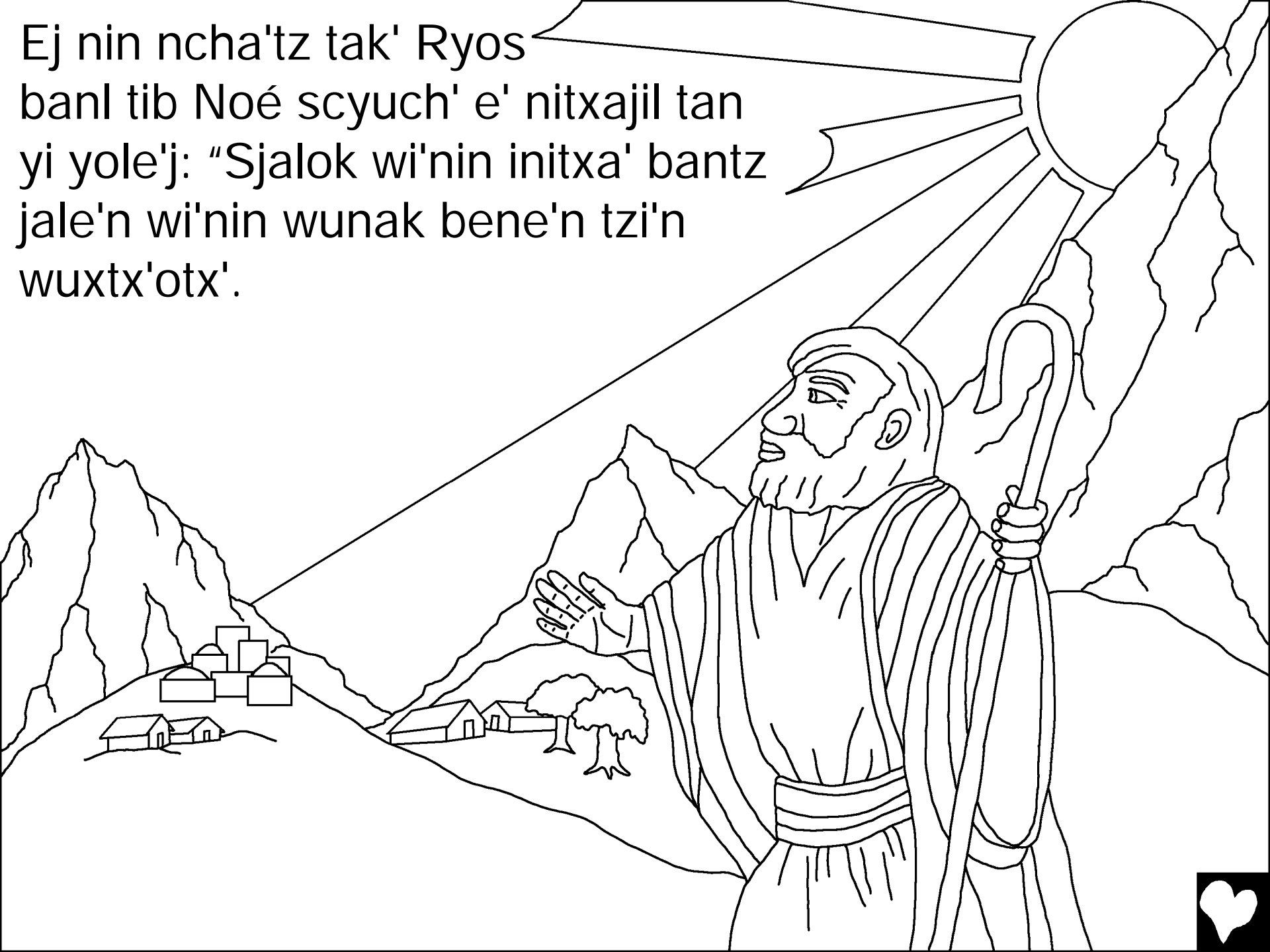

Je chibi' yi e' cy'ajl Noé
yi e' eltzaj te'j le barc: Sem, Cam, nin Jafet.
Yi Cama'tz, ya'stzun taj
Canaán. Nin tan chixonl yi ox cy'ajl
Noé-a'tz, ja noj junt tir yi
wuxtx'otx' cya'n wunak."



Ya'stzun
sbajok na wi'nin na
pek' Ryos scye'j cyakil yi e' wunak yi ate'
wi munt. Cha'stzun te saje'n xchakol yi
jun tal xutuj Cy'ajl tzone'j. Nin alchok
scyetz yil k'uke' c'u'l te yi jun tal xutuj
Cy'ajl Ryosa'tz, nk'e'tz sotzel wutz
sbne', ma na scambaje'
yi itz'ajbil yi qui
bajsbe'n
tetz.



Romanos 3:23

Yi saje'n o' len cu'n juchul il. Na cya'l jun yi jajk jepon tan banle'n tane'n yi tajbil Ryos.

Romanos 6:23

Na yi chichojo'n yi e' juchul il i'tz yi quimichil. Poro yi oy yi na tzan Ryos tan toye'n sketz tan Cristo Jesús, yi Kajcaw, i'tz jun itz'ajbil yi quinín bajsbe'n tetz.

Hebreos 9:27

Jun ntzi' tir na kaquim ketz, nin xom tzaj yi ma'le'n kajtza'kl.

Efesios 2:8,9

Tan tu' banl talma' Ryos nkaclaxe't yi k'ukewe'n kac'u'l te'j. Poro quinín kaclax tan tu' yi ketz kabalajil, ma na cotzi'n nkulej tetz Ryos



Na qui na kaclax tan yi e'chk takle'n balaj yi na kaban.
Na qui na taj Ryos yi nink kocsaj kib nim.

Romanos 10:9,10

Na kol kal len scyetz wunak: "Jesús, ya'stzun yi wetz Wajcaw," nin kol kocsaj cunin yi Ryos je'san tzaj xchixo'l alma', skaclaxok tzuntz. Poro tajwe'n yi tetz cu'n kalma' yil kocsaj yi yol i', bantz jale'n kabalajil swutz Ryos. Ej nin ko na kaj kaclax, tajwe'n yil kal yi Jesucristo i' Kajcaw.

Juan 3:16,17

"Ya'stzun sbajok na wi'nin na pek' Ryos scye'j cyakil yi e' wunak yi ate' wi munt. Cha'stzun te saje'n xchakol yi jun tal xutuj Cy'ajl tzone'j. Nin alchok scyetz yil k'uke' c'u'l te yi jun tal xutuj Cy'ajl Ryosa'tz, nk'e'tz sotzel wutz sbne', ma na scambaje' yi itz'ajbil yi qui bajsbe'n tetz.



Qui saj xchakol Ryos yi Cy'ajl tan tak'le'n chicaws wunak,
ma na saj xchakol tan chicolpe'n tk'ab il c'ol.

Bajx Juan 5:11-13

Poro yi mero xe' yi xtxolbil yi bita'nt ka'n, i'tz yi at jun itz'ajbil ak'ij sketz tan Ryos. Ej nin yi jun itz'ajbila'tz cho'n na jal ka'n te Cristo. Na ko cho'n k'uklij c'u'l jun yaj te yi Cy'ajl Ryos, ja tzun cambaj i' yi jun itz'ajbila'tz. Poro ko qui k'uklij c'u'l jun te Cy'ajl Ryos, qui'c rmeril yi nink cambaj yi jun itz'ajbila'tz. I bin jalu', yi e'u' kajwutz yi na cyocsaju' yi mbi eka'n tan yi Cy'ajl Ryos na chintzan tan stz'ibe'n nin yi xtxolbila'se'j scyeru' tan tele'n chitxumu' tetz yi ja wi't chicambaju' quitz'ajbilu' tetz ben k'ej ben sak.



Génesis 6 – 10

Storyline by: Edward D. Hughes

Illustrated by: Byron Unger, Lazarus
and Alastair Paterson

Adapted by: M. Maillot; Tammy S.

Awakateko Bible (agu) © 2011 Wycliffe Bible Translators,
Inc. All rights reserved.

<https://live.bible.is/bible/AGUNVS/MAT/1>

©2026 Bible for Children, Inc.

www.M1914.org

www.bibleforchildren.org

