

www.BibleForChildren.org



Juan 14



I bin jalu', quil cxbisunwok. Ma na k'ukek ic'u'l te Ryos,
nin k'ukek ic'u'l swe'j. Na kale atit yi ca'l Intaj, wi'nin
e'chk ama'l at kalel kanajewe't tzituch'. Qui' klo' na wal
cyen tzitetz yi nk'e'tzk bintzi.



Nchimben bin tan nuc'le'n ama'l tetz itetz. Ej nin yil
nuc'x cyen yi ama'l, nu'lt tzun tan iticy'le'n nin. Na
kalel chin najewe't wetz, ya'tz nin cxnajewe't itetz.



Ma yi in wetz, in Wa'n, kitz'un kutzicy kib scyuch'u'
tk'ab Kataj. Ncha'tz nk'e'tz chichucu' tan muc'le'n
q'uixc'uj ma na ncha'tz in, na wi'nin

q'uixc'uj na intij. Ej nin
ja lajluchax yi junit o'

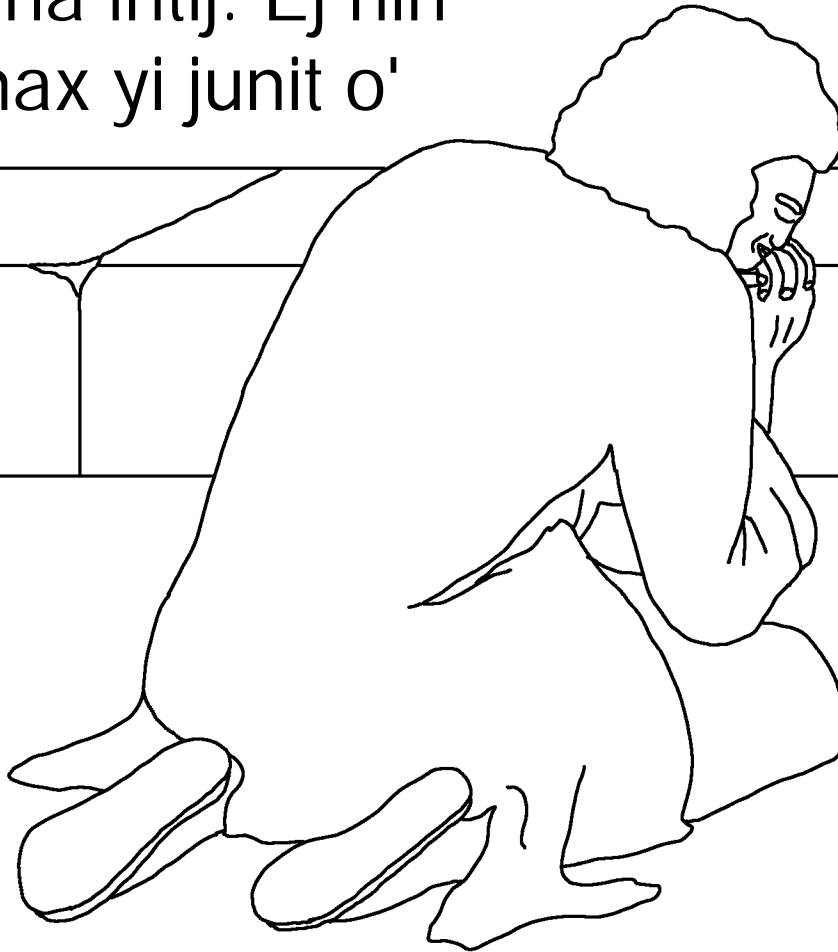

scyuch'u' jak' ca'wl

Ryos, tan tu' yi
nkanimsaj len kac'u'l
tan muc'le'n yi e'chk
q'uixc'uja'tz tan yi
porer Jesucristo.



Ma jalu', je imbanake'j, yi incyaje'n cyen pres tul yi
ama'le'j yi na bi'aj Patmos, yi at nicy'al yi mar.
Cho'n tzun incyaje'n cyen pres tul yi

jun ama'le'j tan paj yi
woque'n tan xtxole'n

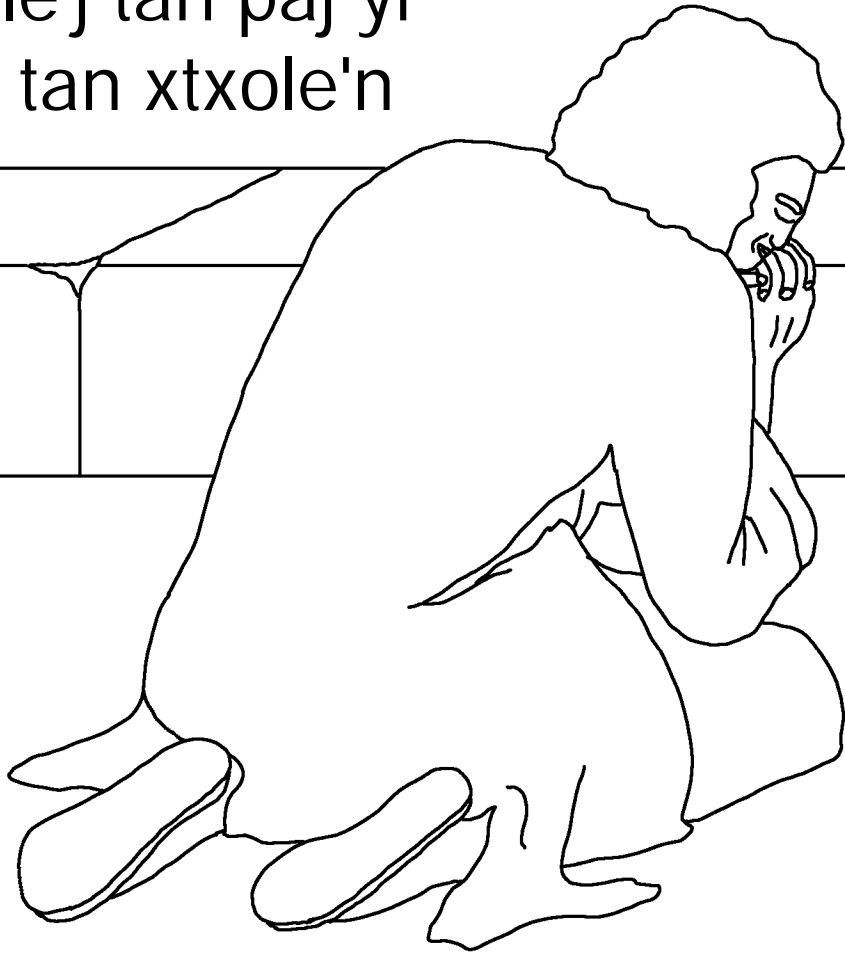

yi Yol Kataj yi
talnak Jesucristo.



Ej nin wil jun balaj c'olchbil, chi tane'n c'olchbil jun
wi'tz ajcaw.



Ncha'tz wit yi chiwi' cyakil jilwutz
txuc yi bnixnake' tan Ryos. Na ja
wit chiwi' cyakil yi e' yi ate' tcya'j,
scyuch' yi e' yi ate' wuxtx'otx'
nin scyuch' cyakil yi
e' yi ate' xe mar.

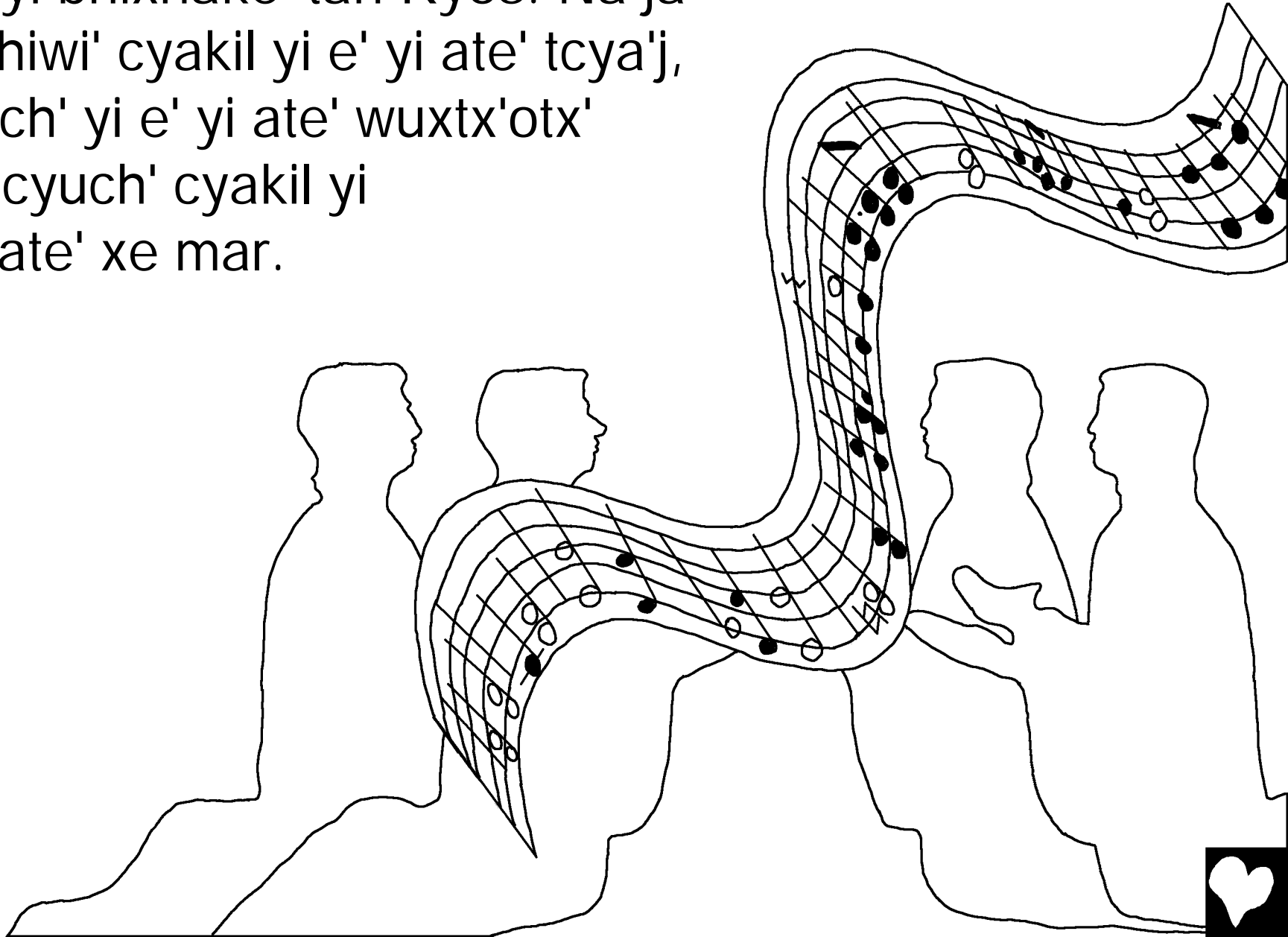

Nin je chiyole'j: "¡Kak'e' kak'ajsbil tetz yi jun yi c'olchij
tibaj yi jun balaj c'olchbile'j. Kak'e' kak'ajsbil tetz yi
tx'ixwatz yi at xlaj. Kak'e' chik'ej na
chin cham nin e'. Kabitzink
xchiwutz, na at chik'ej
tetz ben k'ej ben sak!"
—che'ch tzun
bantz.

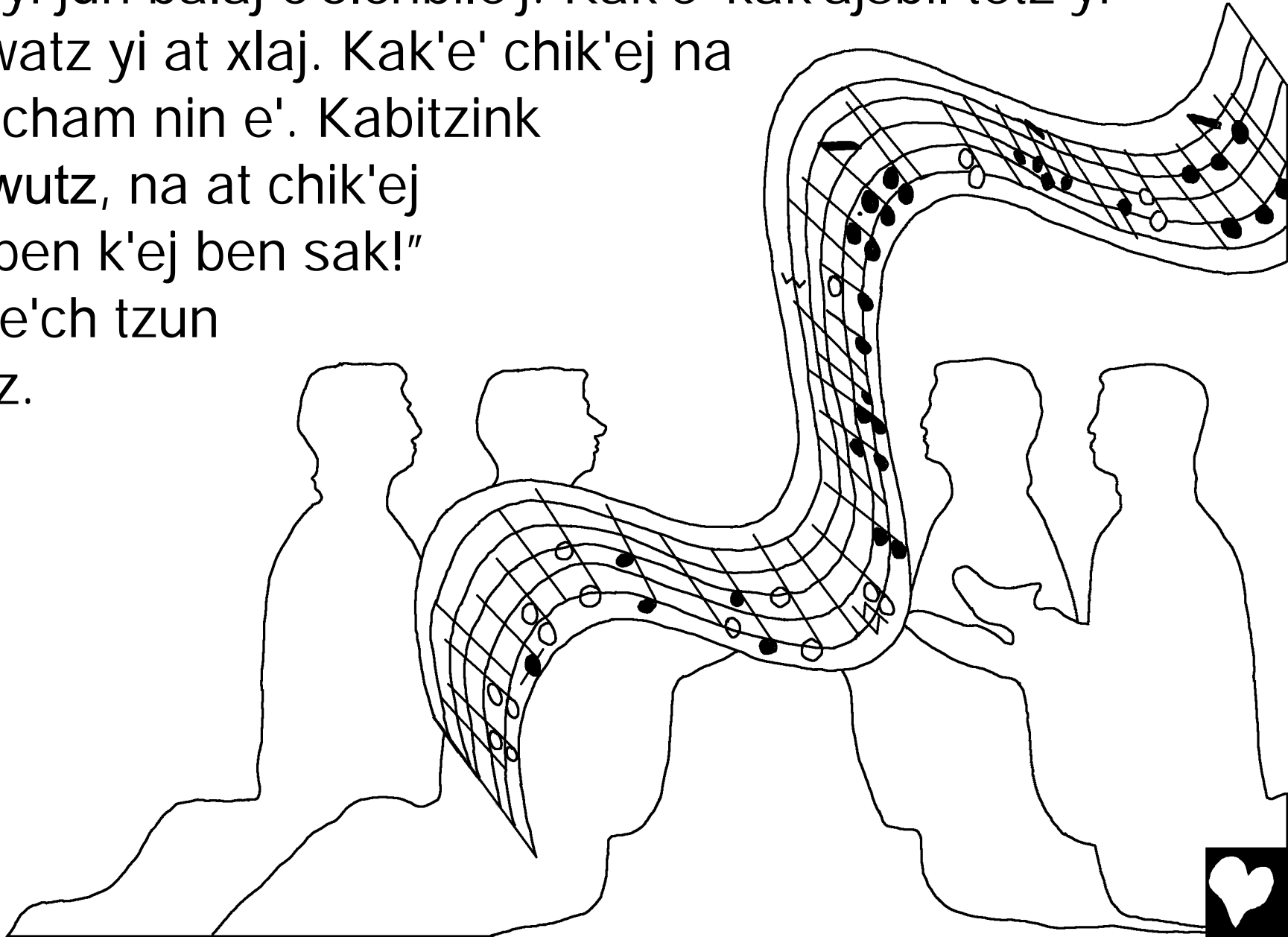

Ej nin tzinwutz cunin, yi in, yi in Wa'n, yi cwe'n
mule'n yi ac'aj Jerusalén, tibaj yi jun ac'aj
luwara'tz. Ya'stzun yi jun tnuma'tz yi chin
xan nin. Cho'n tpone'n tzaj tcyaj kale atit Kataj
Ryos. Chin
yube'n nin yi
jun tnuma'tz.
I cunin jun xun
yi umewe'n tlen
tu' atit, yi chin
weko'n
nin tib.

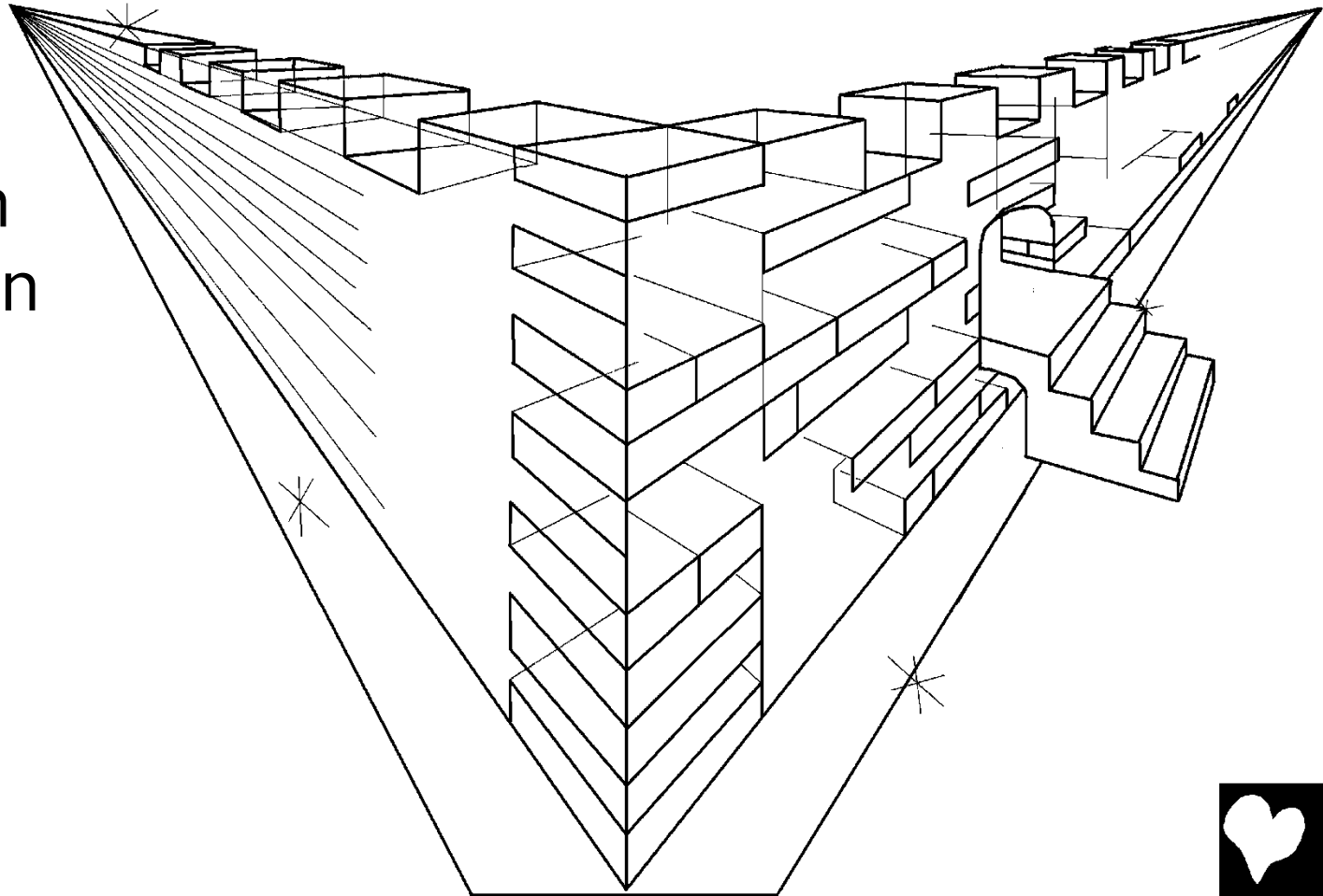

Bene'n tzun wital jun yi chin wi' nin ban tzaj swetz.
Itzuntaltz: "Yaj, bit tzaj. Snajank Ryos xchixo'l
wunak sbne' opon tunintz. Stz'a'tok xchixo'l, nin
tetz cu'n i' xchibne' cyakil jilwutz wunak,
na tz'ocopon i'
tetz mero
chiRyosil."

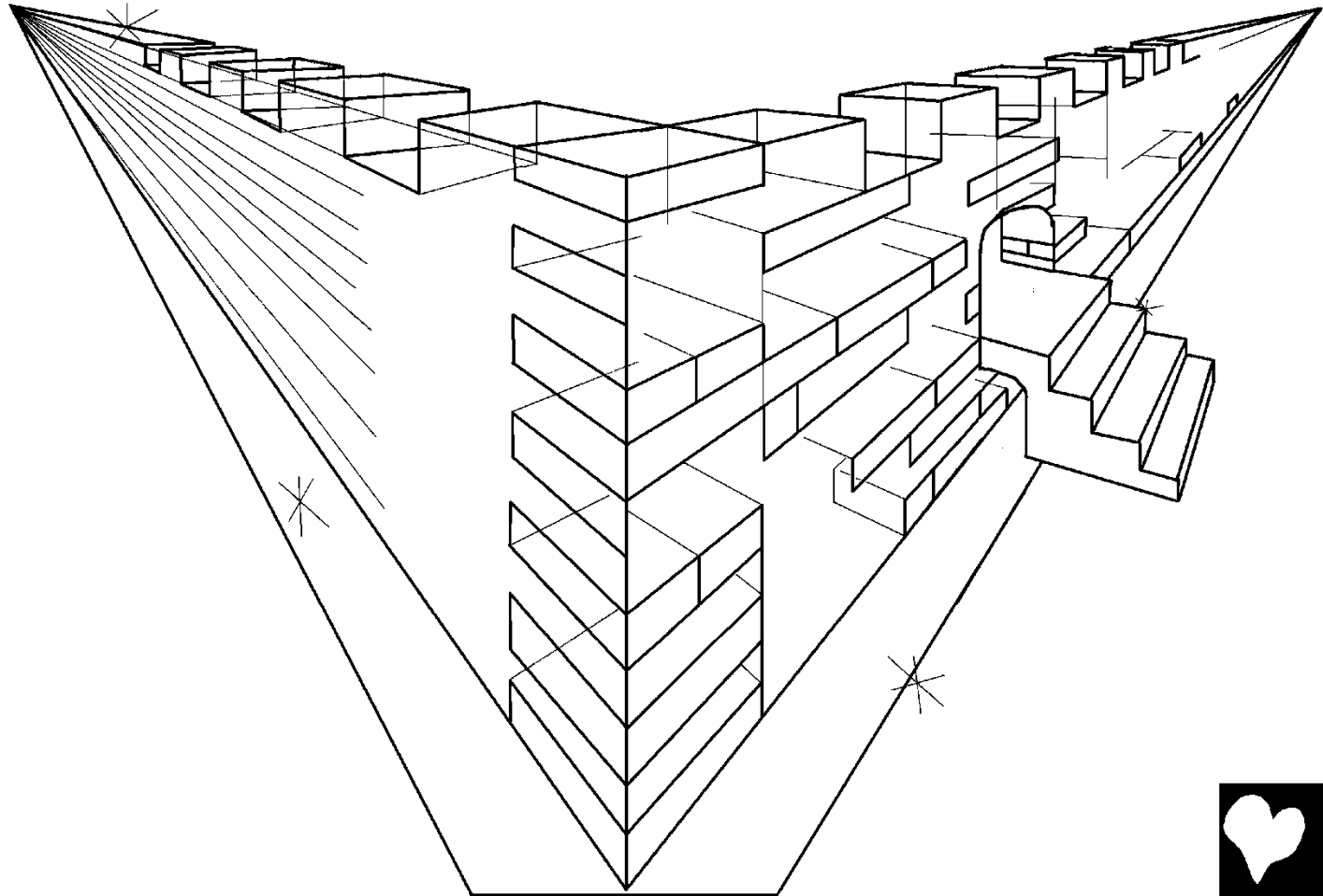

Ncha'tz x̄chaj yi ángel jun chin a' swetz, yi a' yi na tak' itz'ajbil. Cho'n na el tzaj swutz yi c'olchbil Ryos tu yi c'olchbil yi Katx'ixwatz. Yi jun chin a'a'tz chin skoj nin. I cunin spej tane'n. Nin cho'n na xon nicy'al yi be' yi at xo'l ca'l.



Ncha'tz wil tul yi jun tnuma'tz yi qui tajwe'n tkan k'ej, nin qui tajwe'n tkan xaw tan xtxeke'n. Na yi pak'puchal Ryos tu yi pak'puchal yi Katx'ixwatz na xcye' tan xtxeke'n cyakil yi tnum.



Poro quil tz'ak'lij ama'l tetz jun tan toque'n
tul yi jun tnuma'tz ko na ban e'chk takle'n
cachi'. Quil tz'ak'lij ama'l tetz jun
subul nak tan toque'n le
jun tnuma'tz, ma na
ntin tz'ak'lok ama'l
scyetz yi e' yi cu'nak
chibi' tul yi jun planiy
kale cu'nakit chibi' yi
e' yi xchicloxok. Yi
planiya'tz, cho'n cy'a'n
tan Katx'ixwatz.

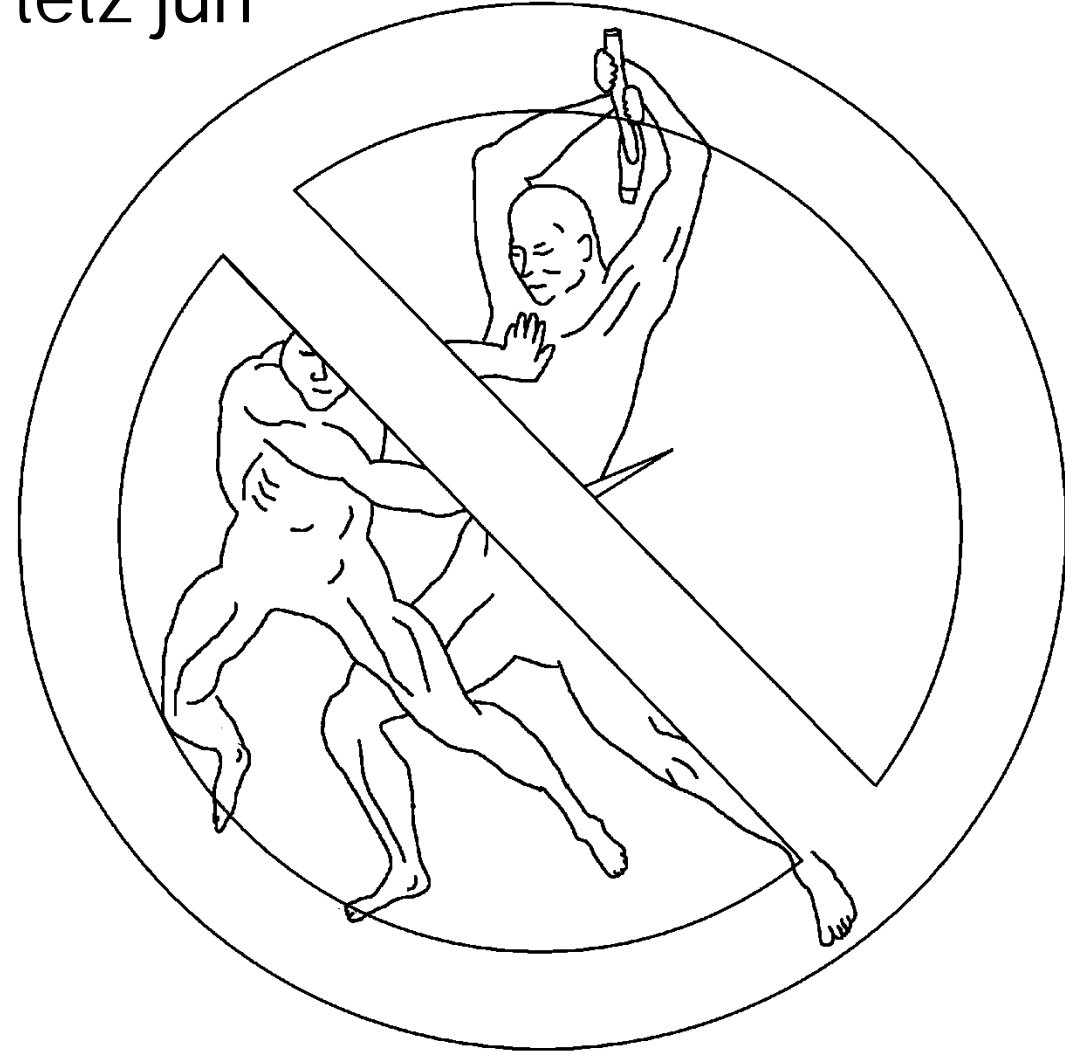

“Qui'ct bis o'kl Ibajij. Nin cyalt chunan, na qui'ct quimichil. Ej nin qui'ct Itaj cyen ch'on scye'j, na nk'e'tz cho'n sbne' chi banak cyen,” stzun yi juna'tz ban swetz.



Qui't Icawsij jun e'chk takle'n tan Ryos. Ya'stzun atit yi c'olchbil Ryos tu yi c'olchbil yi Katx'ixwatz. Ej nin ya'stzun kalel cho'que't yi e' xchakum Ryos tan c'u'laje'n i'. Squile' len wutz Ryos, nin tz'ocopon bi' i' wutzak chiplaj.



Bene'n tzun wilol cyakil yi e' quimnake'. Txiclche' swutz Ryos. At nitxa', nin at tijlc'u'lal. Tircu'n ate'. Nintzun oc jun tan jakle'n yi e'chk liwr yi at tcya'j. Ncha'tz yi junt liwr kale tz'ibane't chibi' cyakil yi e' yi xchicambok te yi itz'ajbil. Nintzun baj oc ma'le'n cyajtza'kl.

Xomquen tu' te yi mbi baj chibnol, na tz'iba'nt cyen tul yi e'chk liwra'tz yi mbi cu'n mbaj chibnol. Ej

nin ya'stzun yi k'ak' kalel chibene't c'oxij cyakil yi e' yi qui cu'nak chibi' tul yi liwr kale tz'ibane't chibi' yi e' yi xchicambok te yi itz'ajbil.

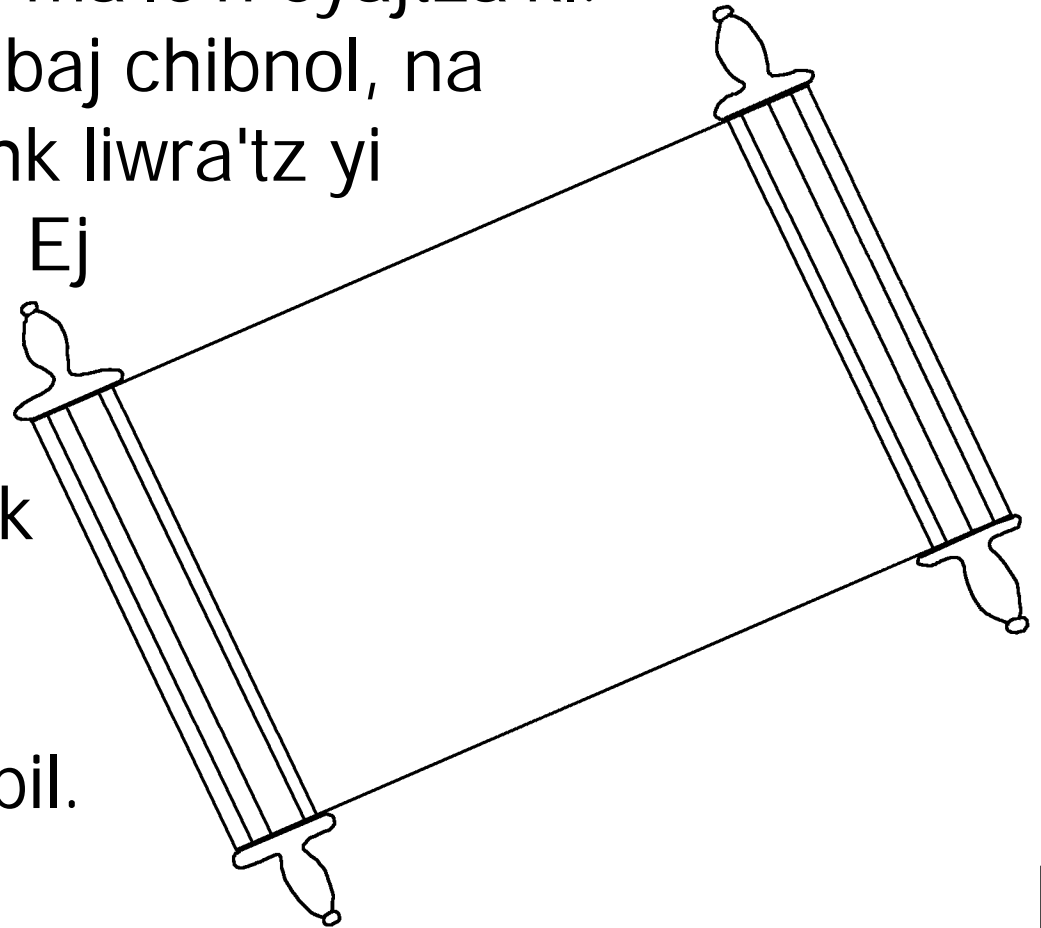

"Ba'n cxu'l," chij yi Espíritu Sant scyetz cyakil wunak.
"Ba'n cxoc tk'ab Kataj," che'ch yi cmon creyent,
yi txkel yi Katx'ixwatz tane'n.

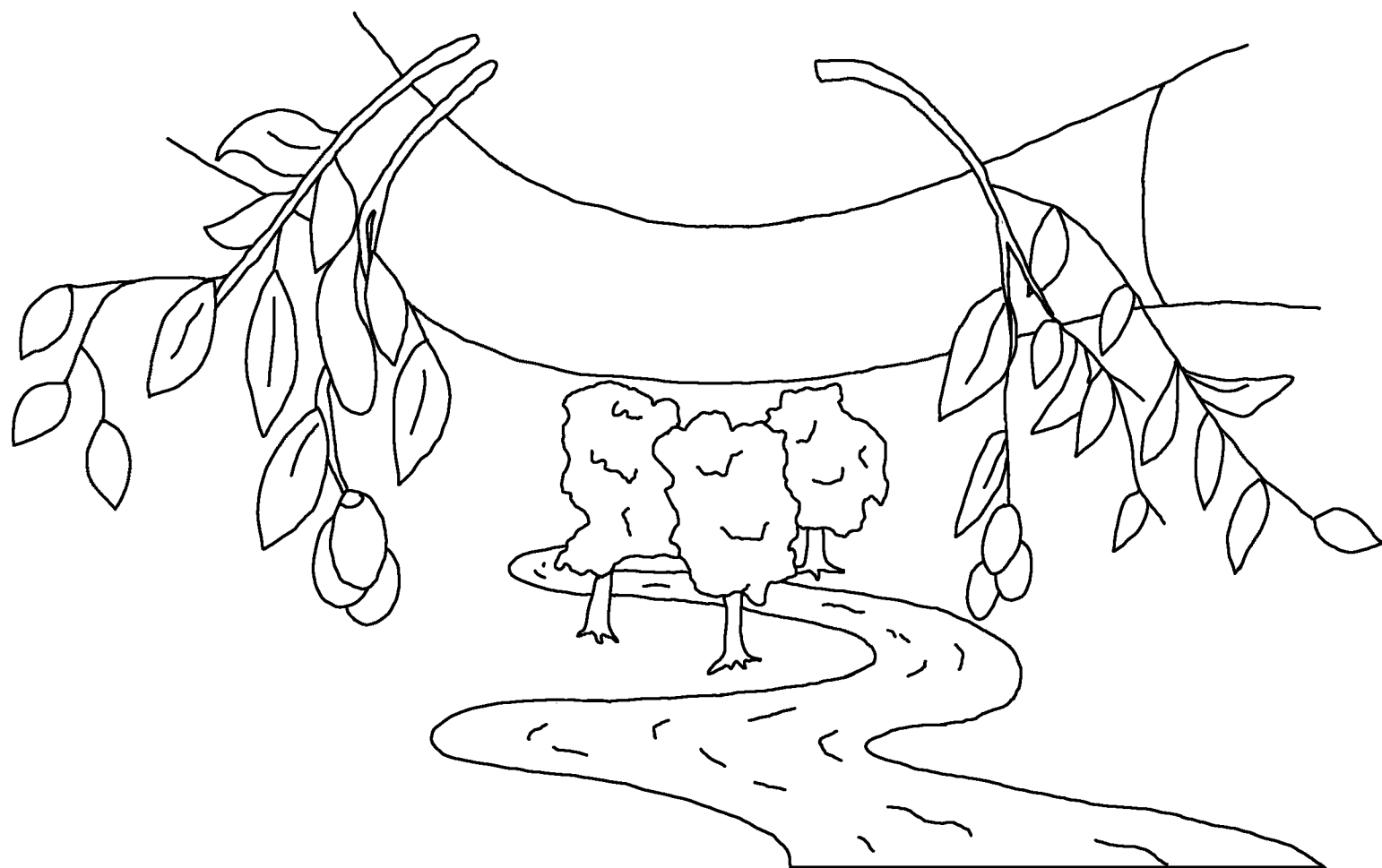

Ej nin cyakil yi e' yi na quibit yi xtxolbile'j tajwe'n lcyal:
"Ba'n tz'oc'u' tk'ab Kataj." Cyakil yi e' yi na chiquim tan
saktzi' ba'n lchu'l tan uc'a'e'n te yi a' yi na tak'
itz'ajbil, nin qui'c jamel na taj.



Ya'stzun
sbajok na wi'nin na
pek' Ryos scye'j cyakil yi e' wunak yi ate'
wi munt. Cha'stzun te saje'n xchakol yi
jun tal xutuj Cy'ajl tzone'j. Nin alchok
scyetz yil k'uke' c'u'l te yi jun tal xutuj
Cy'ajl Ryosa'tz, nk'e'tz sotzel wutz
sbne', ma na scambaje'
yi itz'ajbil yi qui
bajsbe'n
tetz.



Romanos 3:23

Yi saje'n o' len cu'n juchul il. Na cya'l jun yi jajk jepon tan banle'n tane'n yi tajbil Ryos.

Romanos 6:23

Na yi chichojo'n yi e' juchul il i'tz yi quimichil. Poro yi oy yi na tzan Ryos tan toye'n sketz tan Cristo Jesús, yi Kajcaw, i'tz jun itz'ajbil yi quinin bajsbe'n tetz.

Hebreos 9:27

Jun ntzi' tir na kaquim ketz, nin xom tzaj yi ma'le'n kajtza'kl.

Efesios 2:8,9

Tan tu' banl talma' Ryos nkaclaxe't yi k'ukewe'n kac'u'l te'j. Poro quinin kaclax tan tu' yi ketz kabalajil, ma na cotzi'n nkulej tetz Ryos



Na qui na kaclax tan yi e'chk takle'n balaj yi na kaban.
Na qui na taj Ryos yi nink kocsaj kib nim.

Romanos 10:9,10

Na kol kal len scyetz wunak: "Jesús, ya'stzun yi wetz Wajcaw," nin kol kocsaj cunin yi Ryos je'san tzaj xchixo'l alma', skaclaxok tzuntz. Poro tajwe'n yi tetz cu'n kalma' yil kocsaj yi yol i', bantz jale'n kabalajil swutz Ryos. Ej nin ko na kaj kaclax, tajwe'n yil kal yi Jesucristo i' Kajcaw.

Juan 3:16,17

"Ya'stzun sbajok na wi'nin na pek' Ryos scye'j cyakil yi e' wunak yi ate' wi munt. Cha'stzun te saje'n xchakol yi jun tal xutuj Cy'ajl tzone'j. Nin alchok scyetz yil k'uke' c'u'l te yi jun tal xutuj Cy'ajl Ryosa'tz, nk'e'tz sotzel wutz sbne', ma na scambaje' yi itz'ajbil yi qui bajsbe'n tetz.



Qui saj xchakol Ryos yi Cy'ajl tan tak'le'n chicaws wunak,
ma na saj xchakol tan chicolpe'n tk'ab il c'ol.

Bajx Juan 5:11-13

Poro yi mero xe' yi xtxolbil yi bita'nt ka'n, i'tz yi at jun itz'ajbil ak'ij sketz tan Ryos. Ej nin yi jun itz'ajbila'tz cho'n na jal ka'n te Cristo. Na ko cho'n k'uklij c'u'l jun yaj te yi Cy'ajl Ryos, ja tzun cambaj i' yi jun itz'ajbila'tz. Poro ko qui k'uklij c'u'l jun te Cy'ajl Ryos, qui'c rmeril yi nink cambaj yi jun itz'ajbila'tz. I bin jalu', yi e'u' kajwutz yi na cyocsaju' yi mbi eka'n tan yi Cy'ajl Ryos na chintzan tan stz'ibe'n nin yi xtxolbila'se'j scyeru' tan tele'n chitxumu' tetz yi ja wi't chicambaju' quitz'ajbilu' tetz ben k'ej ben sak.



Juan 14; Ca'p Corintios 5; Apocalipsis. 4, 21, 22

Storyline by: Edward D. Hughes

Illustrated by: Lazarus
and Alastair Paterson

Adapted by: Sarah S.

Awakateko Bible (agu) © 2011 Wycliffe Bible Translators,
Inc. All rights reserved.

<https://live.bible.is/bible/AGUNVS/MAT/1>

©2026 Bible for Children, Inc.

www.M1914.org

www.bibleforchildren.org

