

[www.BibleForChildren.org](http://www.BibleForChildren.org)



Juan 14



Angkay hiyachi yag imfagan Jesus an chàni way pasorotna way mangaliyén, "Achiayu machanagan ah uray heno, ta anyu yanggay ammag manokchun ah Apudyus ya manokchunyu agé haén. Te ammag nawaya hen iggawan ah faréy Ama, wat epangpangò ta iyà es agana hen iggawanyu."

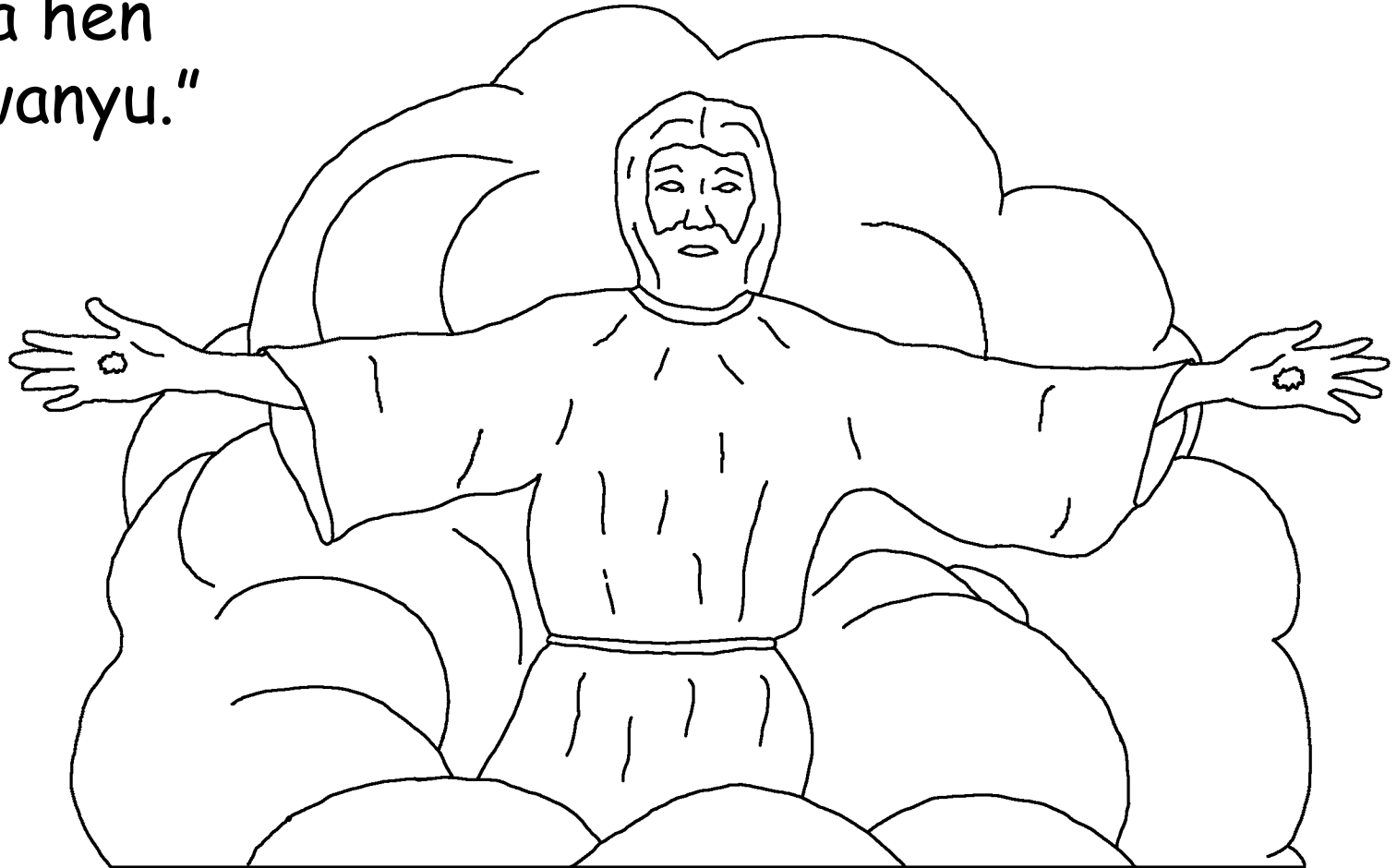

“Yag achì agé ammag cha aryén chato no faén tot-owa. Yag no éméyà way mangensagana hen iggawanyu, mamfangachà chillu agé way mangara an chàyù ta hen iggawà, yachi agé hen iggawanyu.”



Haénay Juan way sonodyu, ifà paat chàyü hen  
chataaw manganohan hen chataaw maligatan  
gapon chataaw omafurotan

an Jesu Cristu, ya  
ifà agé chàyü hen

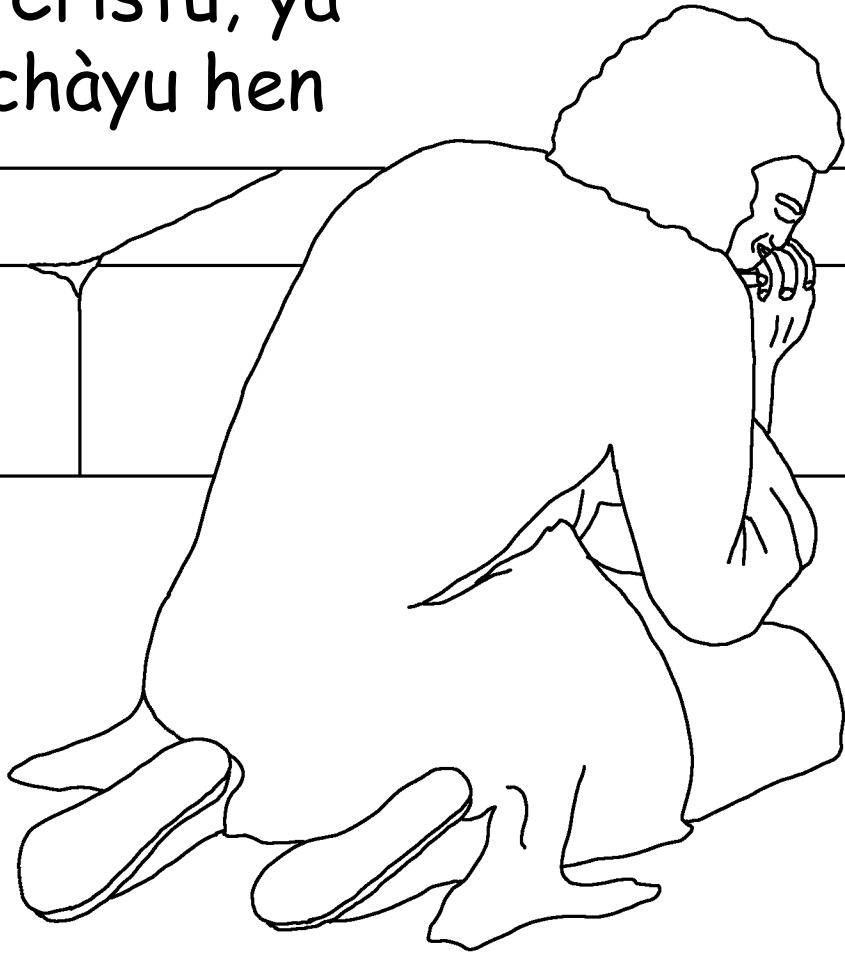

metatapyantaaw  
hen mantorayan  
Apudyus.



Wat haén way sonodyu, anà ammag neporwak  
hen antoy lota way nanggagawa hen fayfay  
way ekatchéén Patmos, gapon chà

manginwarawagan  
hen alen Apudyus

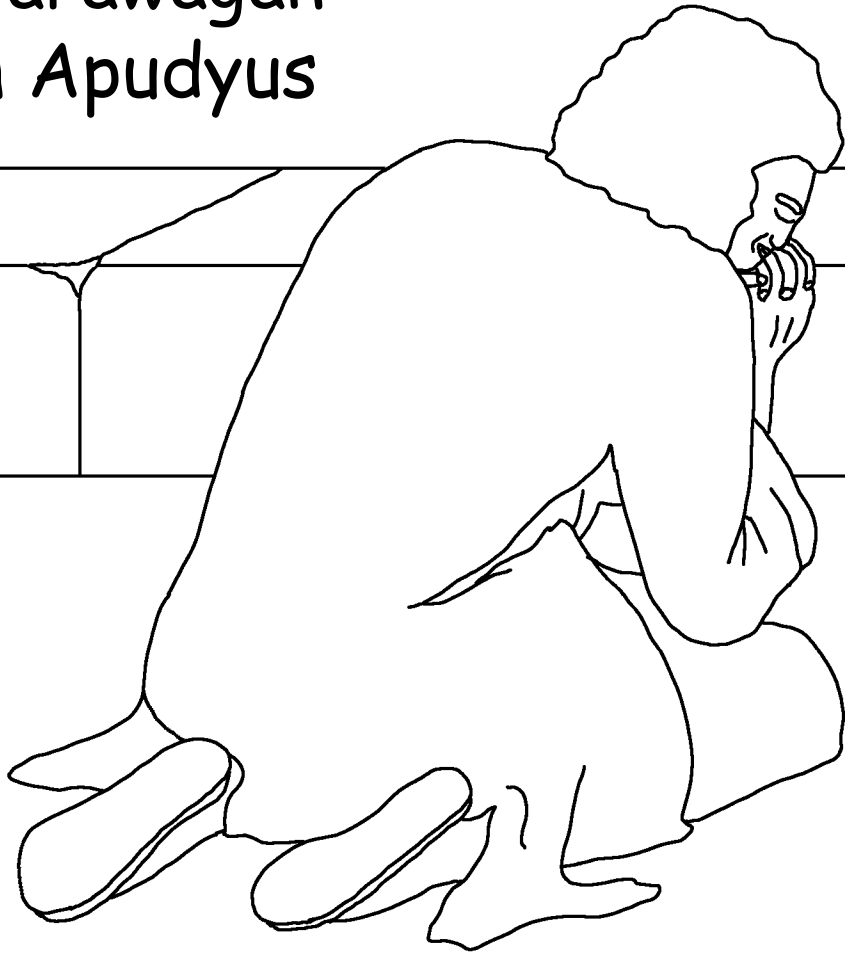

ya hen anchi  
katot-owaan way  
empaka-ammun  
Jesus.



Yag hen hiyachi, pinchénà hen Espiritun Apudyus  
yag wachaa-at ad uchu. Yag angkay ahchi, innila-at  
agé hen ihay tùchu way tùchun chi Are yag wacha  
agé hen tummutùchu.



Yachi yag chengngar-owat agé hen nankankantaan  
hen egachay chan ì-iwi, te netape hen egachay  
wachad uchu ya umat agé hen  
antoy lota, ya hen egachay  
iniggaw hen fayfay ya umat agé  
hen anchichay aminay ininggaw  
hen kawad-an hen natéy.

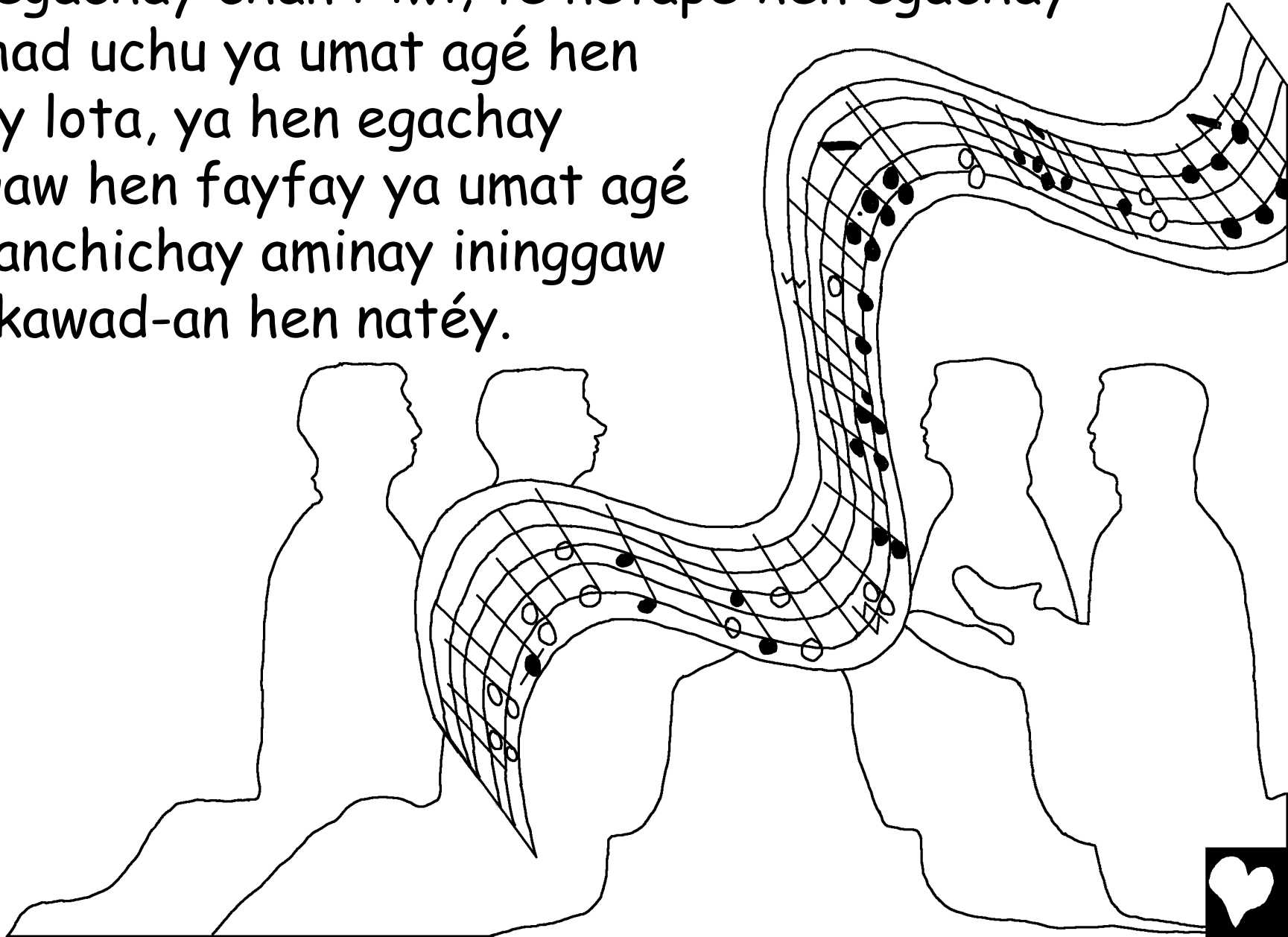

Wat chacha amin mèkankanta way mangaliyén,  
"Hen anchi tummutùchu way Are ya hen anchi  
Karnero, ancha yanggay ammag  
machachayaw ah ing-inggana ya  
mepagngapagngar yanggay hen  
kaenammaycha ya hen  
kenangatocha ya hen

mannakafalincha  
ah ing-inggana  
way maid  
péppégna."

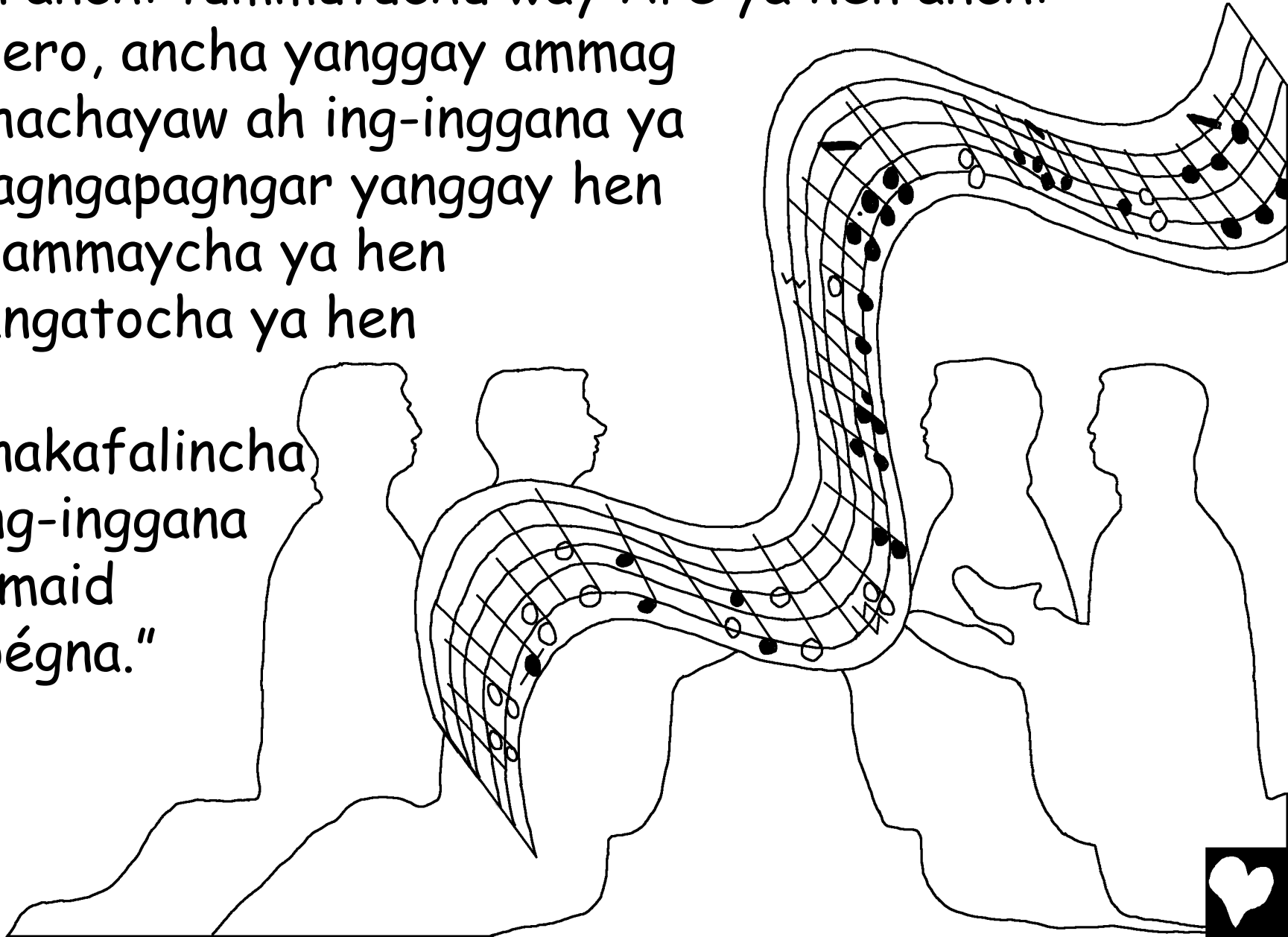

Yag innilà agé hen anchi cha émhépan hen anchi  
fabréy Apudyus way narpon hiya ad uchu way yachin  
anchi faru way Jerusalem. Yag ammag am-ammay hen  
anchi fabréyanchi te kaman yanggay hen ka-ammay  
hen ihay fufae way nanlurumfong ah am-ammay way  
lumfong ah  
para hen  
mèkasarana.

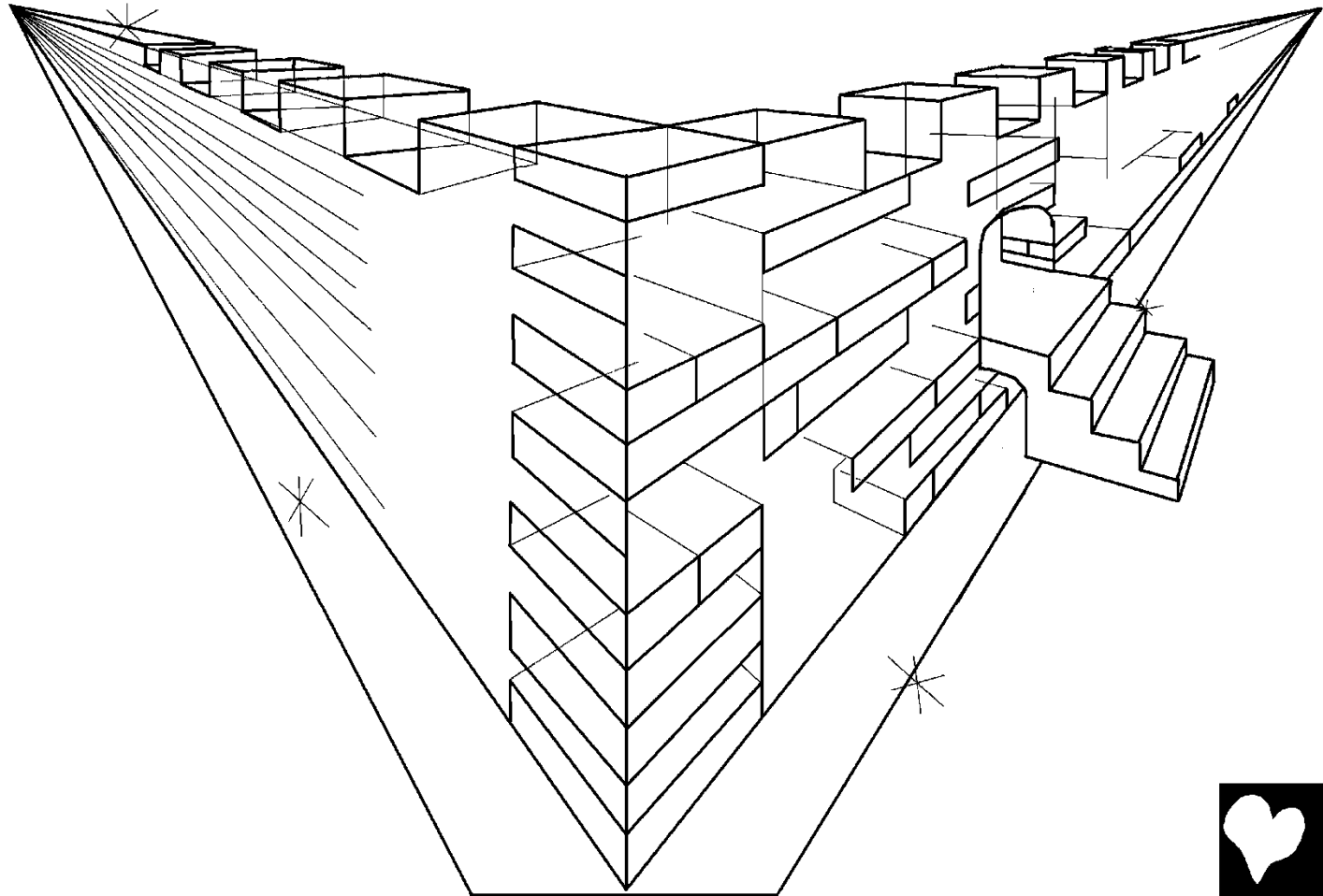

Yachi yag chengngar-o agé hen anchi chakaray  
ale way narpon anchi tummutùchuwan Are way  
ekatnéén, "Inumchah ad uwan hen mifaryan  
Apudyus hen tatagu, wat mì-i-iggaw an chicha ta  
mantataguna

chicha,  
yag hiya,  
mawawà-acha  
an chicha ta hiya  
yanggay hen  
chachayawéncha."

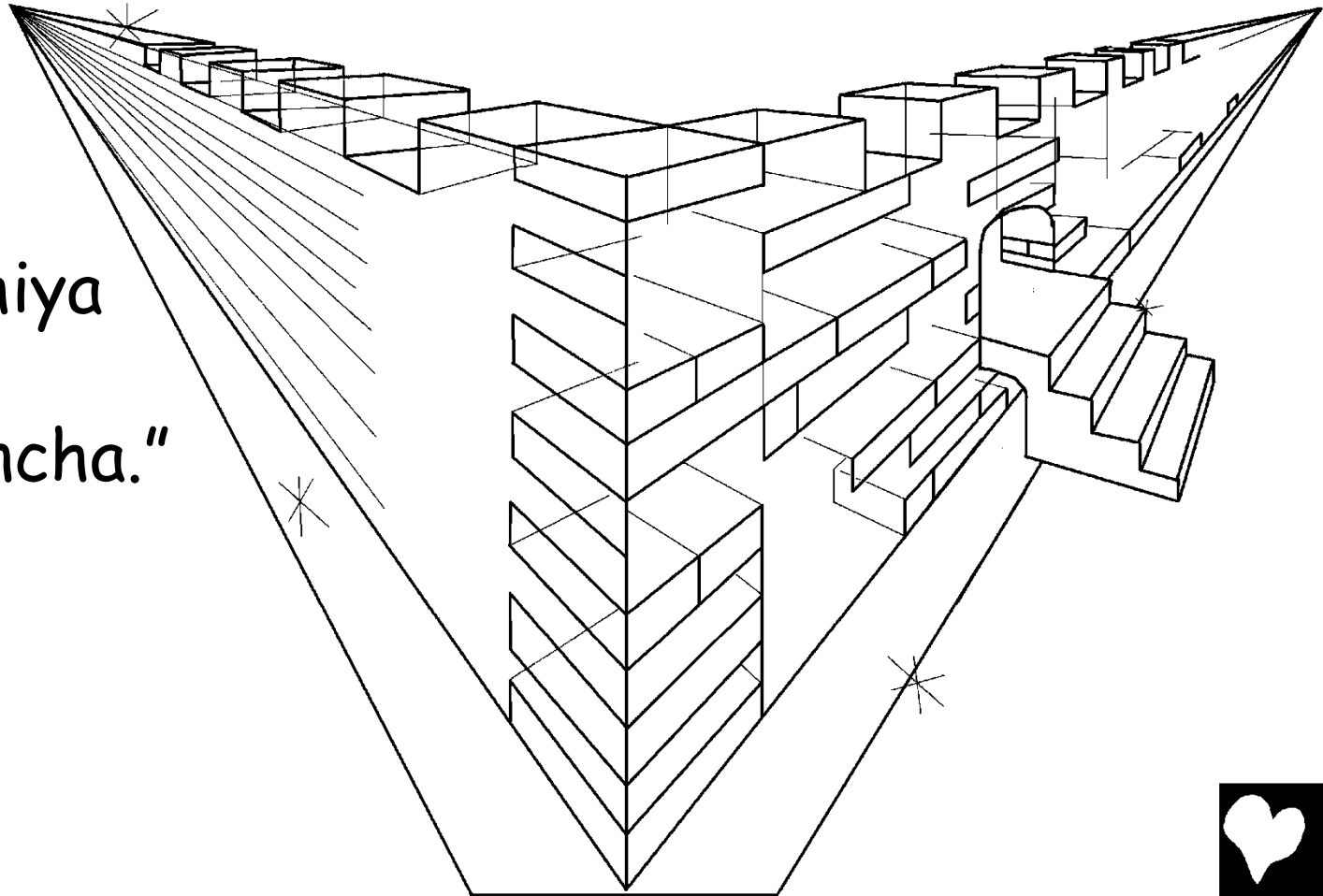

Angkay hiyachi yag empàilan agé hen anchi anghel an  
haén hen anchi chan kolenawnaw way wangwang way  
ammag chan aletaggaw hen chanumna way yachin cha  
managu hen tatagu. Yag hen niyuuchan hen anchi  
wangwang wat hen iggaw paat hen tummutùchuwan  
Arey Apudyus ya hen anchi Karnero.



Ya hen hiyachiy fabr y ag , achina masapor  
hen init ya hen h rag ah kahelawana, te ammag  
machichillangan ah kenafusel Apudyus ya  
mahehellawan ah kahelaw hen anchi Karnero, wat  
aminay katagutagu hen antoy lotaat mahehellawancha  
amin ah kenahilina.

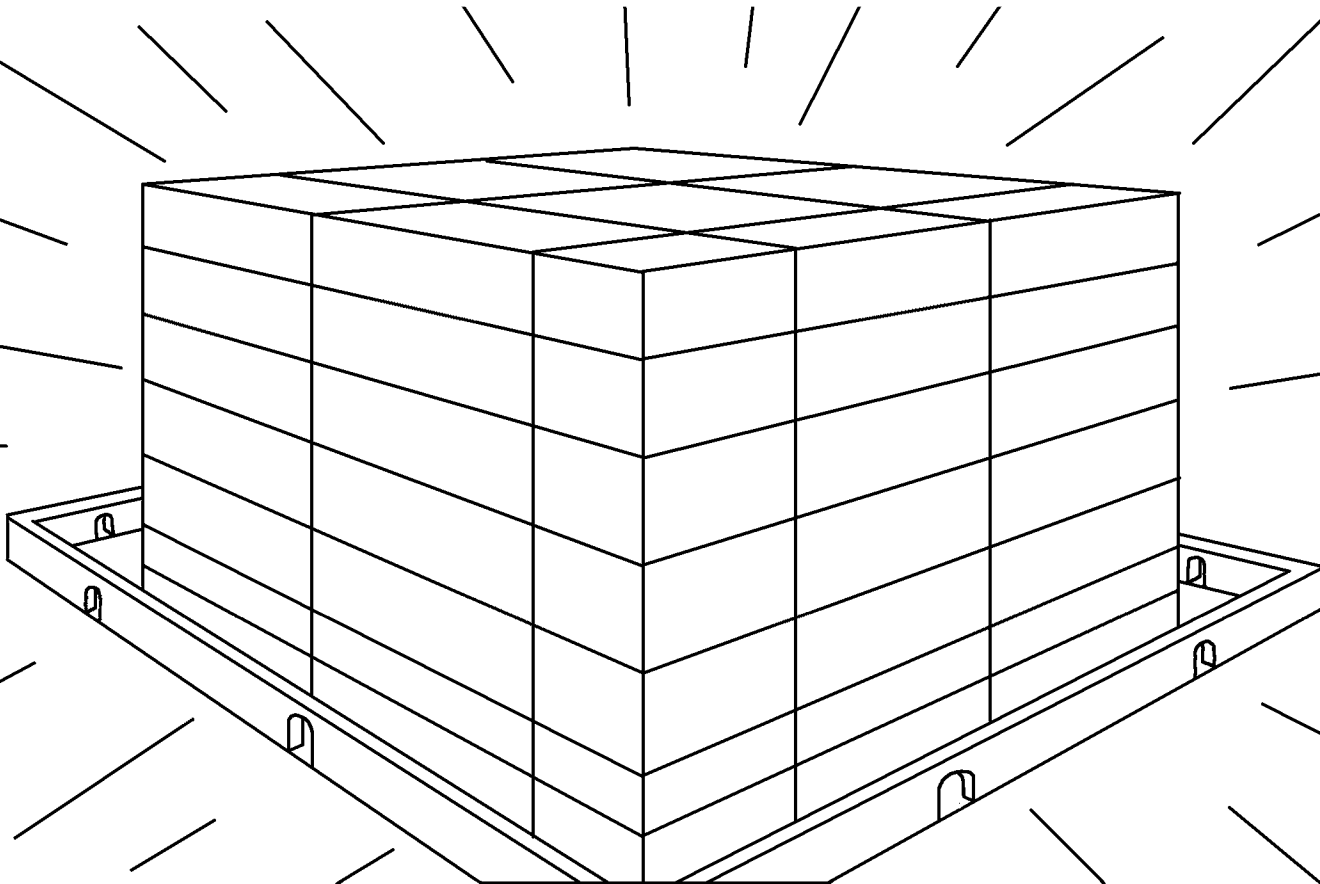

Ngém ammag achi mafalin hénggép hen uray heno way cha mangam-amma hen laweng way kaman hen anchichay mankétém ya cha mangamma hen afifiin. Te hen makaghép yanggayat, hen anchichay nelelesta hen ngachancha hen anchi libnun hen anchi Karnero way yachi hen nelelestaan hen kangachangachan hen amin anchichay mì-iggaw an Apudyus ah ing-inggana.

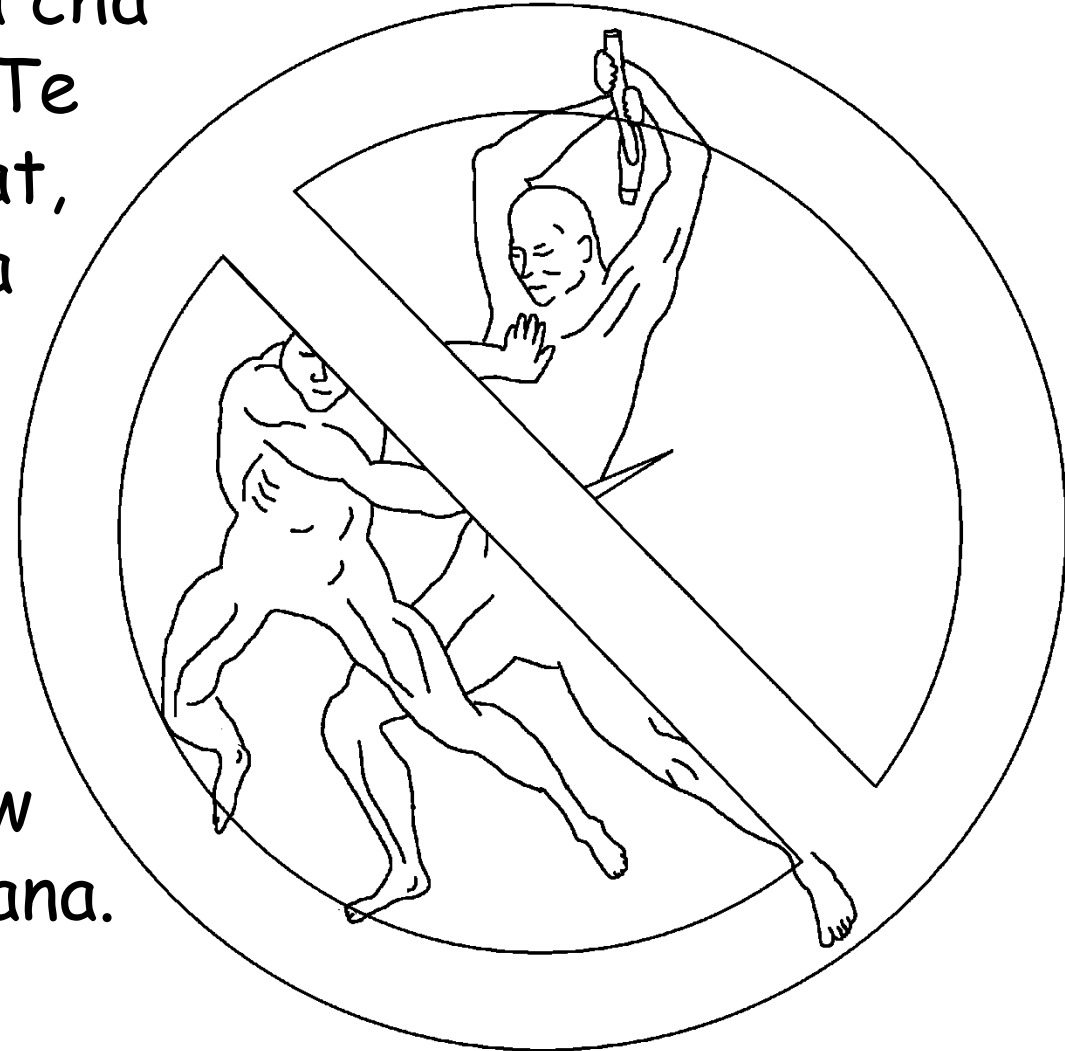

“Yag pònahana agé hen aminay luwacha. Wat maid kasen matmatéy ya maid agé kasen mankek-ela ya man-ib-ifil ya maid agé kasen maligligatan, te amin hen anchichay cha nepasamak hen anchi pés-éy lotaat, anchag namaid amin.”



Ya an agé ammag maid machahan hen hiyachiy  
fabréy ah uray heno way achi laychén Apudyus. Yag  
hen hiyachiy fabréy agé hen tummutùchuwan paat  
Apudyus ya hen anchi Karnero way mantoray, ya ahchi  
agé hen manachayyawan  
hen amin anchichay  
chan sérfi an  
chicha. Wat  
aminchaat ilancha  
paat hen féhar  
Apudyus ya  
masosollatan  
agé hen  
etongcha ah  
ngachanna.



Yachi yag innilà agé hen amin anchichay nan-atéy way tatagu way nepasangocha amin hen anchi tummutùchu. Wat wacha amin hen nan-angato ya hen nan-afafa, ya uray agé hen anchichay cha natéy ah fayfay, te nepa fùnagcha amin. Wat amin hen anchichay nan-atéy way tatagu way ininggaw ad Hades way kawad-an hen natéy, nepafùnagcha amin ta wéhchiyén mauwis way mifisar hen enammaana hen anchi nat atagguwana.

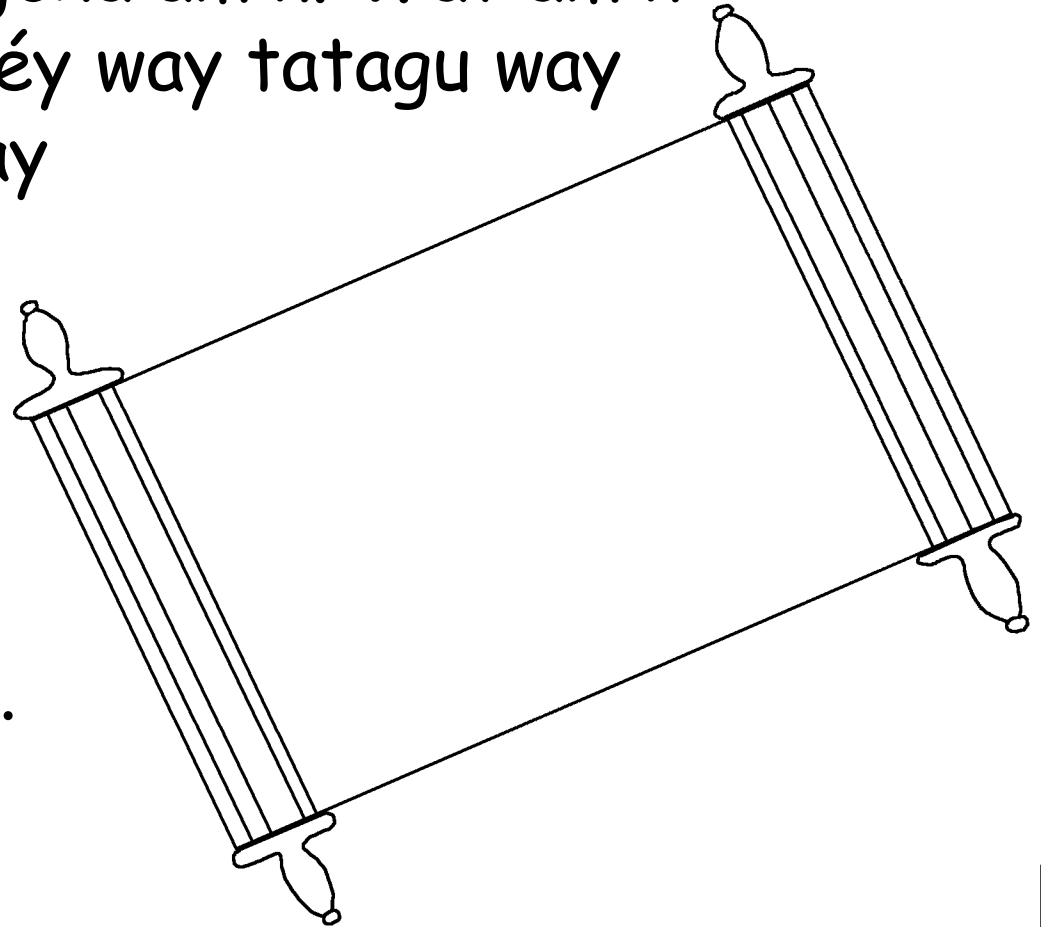

Wat heno way tagu way maid ngachanna hen anchi  
lib nu way nelelestaan hen ngachan hen anchichay  
mì-iggaw an Apudyus, wat chicha hen metap-ar  
hen anchi apoy way kaman fayfay.

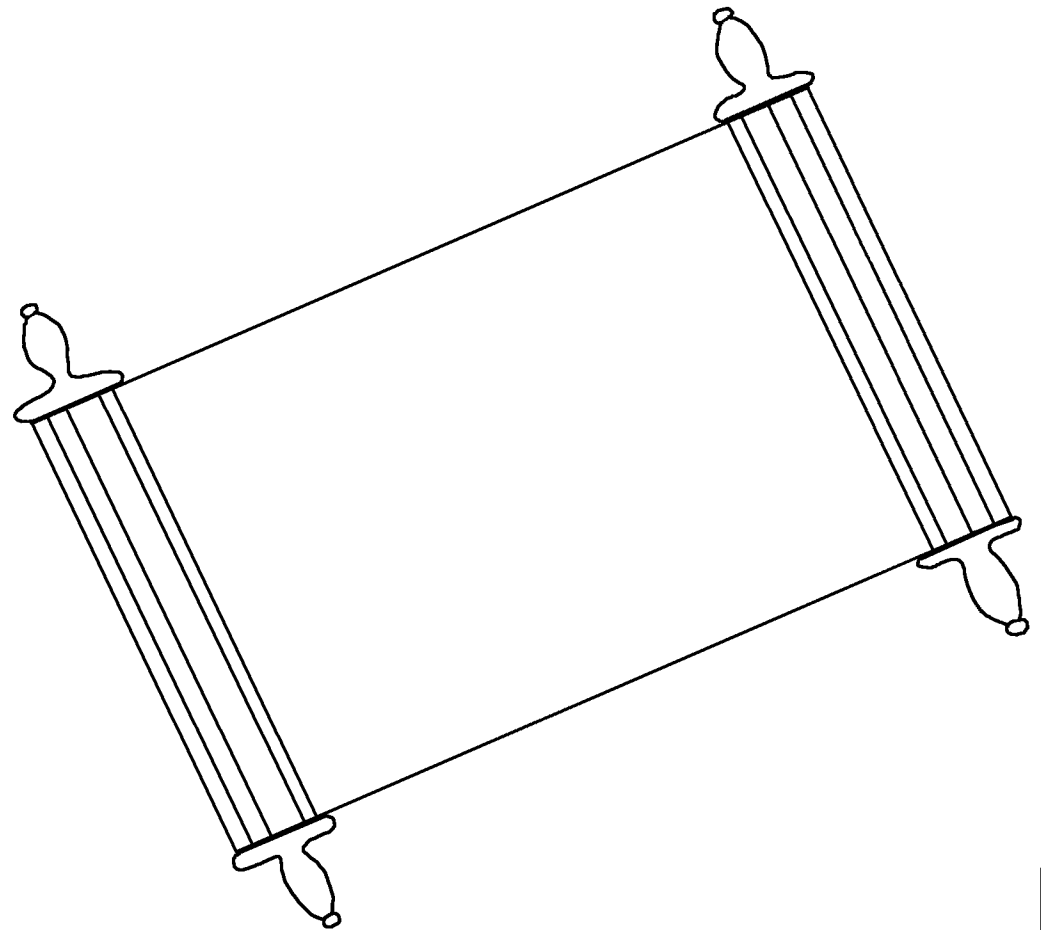

"Wayyuwat ta metapeayu," way ekat hen anchi Espiritun Apudyus ya hen anchichay niyalig ah ahawan hen anchi Karnero. "Oo, wayyuwat amin," way ekat agé hen amin anchichay nangngar an cha natto.



Chacha amin omayag ta amin-ayu way nàwaw,  
umaleayu koma, te heno way manlayad, mafalin  
mì-inum hen anchi chanum way managu hen tatagu  
way maid fab-ayadna.



Te ah Apudyus, gapon anchi amchan  
way layadna hen tatagu, empalena hen  
anchi ih-ihà-an way anàna hen antoy  
lota way matéy ta heno way  
mangafurot hen anchi anàna, achi  
metap-ar te mì-iggaw an hiya  
ah ing-inggana.



eRoma3:23 te an chillug maid tagu ah iggay fummasor, wat maid awanwani hen mangammayan Apudyus an chitaawamin.

eRoma6:23 Te hen fayad hen fasorat hen atéyan way mesena an Apudyus ah ing-ingana. Waman hen anchi iliblin Apudyusat hen anchi mannanayun way mèttaguwan an hiya gapo hen nelarammongantaaw an Apotaaway Jesu Cristu.

Hebrews 9:27 Te kaman an chitaaw way tatagu, te nifafagga way ihaihéén ammag mamenghan yanggay hen matéyana yag anat mauwis.

iyEfeso 2:8 Wat ammag anggay yanggay hen ség-ang Apudyus yag entapena chitaaw an hiya yag gapo yanggay hen ommafurotantaaw an Jesu Cristu way ammag faén gapon anchi ammay way enammaantaaw, te ammag inliblin Apudyus hen ketapyantaaw an hiya.



iyEfeso 2:9 Wat hiyachi hen achi mafalin way  
mampachinar hen uray heno way tagu way mangaliyén  
enammaana ano hen ammayat metape an Apudyus.

eRoma 10:9,10 Te no haphapetén way ah Jesus paat hen  
Ap-apo, yag no afuroton paat agé ah hamhamà way  
hiya hen empauchin Apudyusat yachi hen kahara-an.  
Te hen anchi omafurotantaaw paat an Jesu Cristu wat  
yachi hen mangimfilangan Apudyus an chitaaw ah maid  
fasfasorna an hiya. Yag no haphapeténtaaw chachi hen  
tapena wat yachi hen kahara-an hen kachusaantaaw.

Juan 3:16 Te ah Apudyus, gapon anchi amchan way  
layadna hen tatagu, empalena hen anchi ih-ihà-an way  
anàna hen antoy lota way matéy ta heno way mangafurot  
hen anchi anàna, achi metap-ar te mì-iggaw  
an hiya ah ing-inggana.



Juan 3:17 Iggay hennag Apudyus hen anàna hen antoy  
lota way i manusa hen tatagu, te anna hennag ta wachay  
kahara-an hen tatagu.

1 Juan 5:11-13 Yag hen imfagan Apudyus, ekatnéén  
idchatna an chitaaw hen mannanayun way  
mètaguwantaaw an hiya way hen yachiy mannanayun way  
ataguwan, narpo yanggay hen anchi anàna. Wat heno way  
tagu way wachan anchi anà Apudyus an hiya, looh nidchat  
hen anchi mannanayun way mètaguwana an Apudyus.  
Waman hen anchi tagu way maid anchi anà Apudyus an  
hiya, maid agé anchi mannanayun way mètaguwana an  
Apudyus. Hen mangensoratà an natto an chàyù way  
ommafurot hen anà Apudyus, ta masigurachuyu way  
mètaguayu an Apudyus ah ing-inggana, te looh ninidchat  
an chàyù hen anchi mannanayun way ataguwan.



Juan 14; 2 eCorinto 5;  
Hen nepaka-ammu 4, 21, 22

Storyline by: Edward D. Hughes

Illustrated by: Lazarus  
and Alastair Paterson

Adapted by: Sarah S.

Balangao Bible (blw) © 1982, Wycliffe Bible Translators,  
Inc. All rights reserved.

<https://www.bible.com/bible/1115/MAT.1>

©2026 Bible for Children, Inc.

[www.M1914.org](http://www.M1914.org)

[www.bibleforchildren.org](http://www.bibleforchildren.org)

