

Alkitab Anggen Anak Alit

Samuel, Parekan
Ida Hyang Widi



Kasurat olih: Edward Hughes

Kaperagayang olih: Janie Forest
Alastair Paterson

Ka tempa saking: Lyn Doerksen

Ka dwi aksarayang olih: Ni Luh Mastri Ayu Caerina;
Pdt I Gusti Made Alit Purya

Kakaryanin olih: Bible for Children
www.M1914.org

©2024 Bible for Children, Inc.

Perarem: Ida dane dados nerjemahang utawi nyalin carita puniki,
nanging nenten dados ke adol.



Dane Hanna anak istri ane pari solahne melah pesan, makurenan ajake dane Elkana. Ipun ajak dadue seleg pesan mebakti ring Ida Sang Hyang Widi, tur setate nyinahan kapiaolasan tekenin anak len. Hanna edot pesan ngelah pianak, Dane terus ngestawa

mapinus ring Ida Hyang Widi apange dane kicen pianak. Sube mekelo pesan dane ngestawa, jeg tetep dogen dane tusing ngelah pianak.

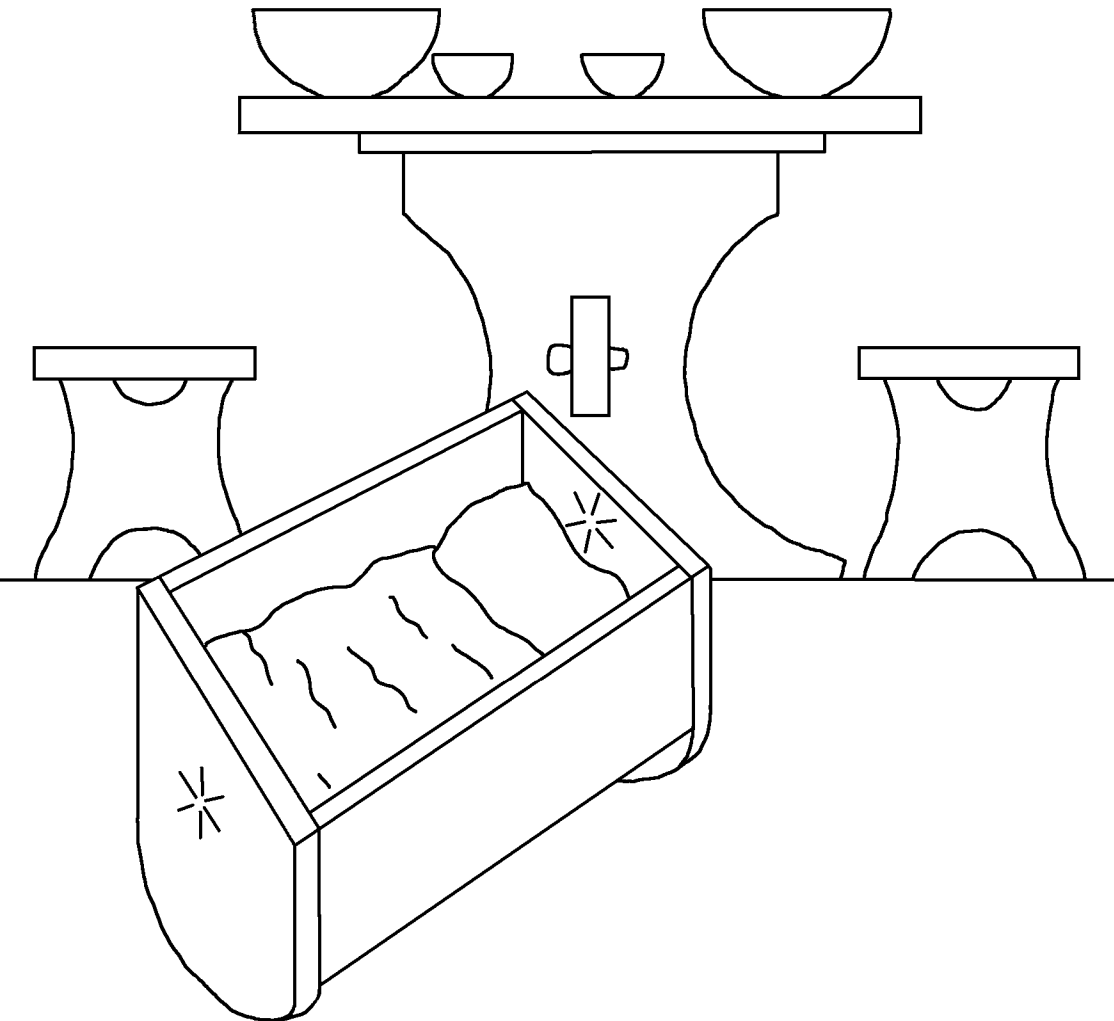

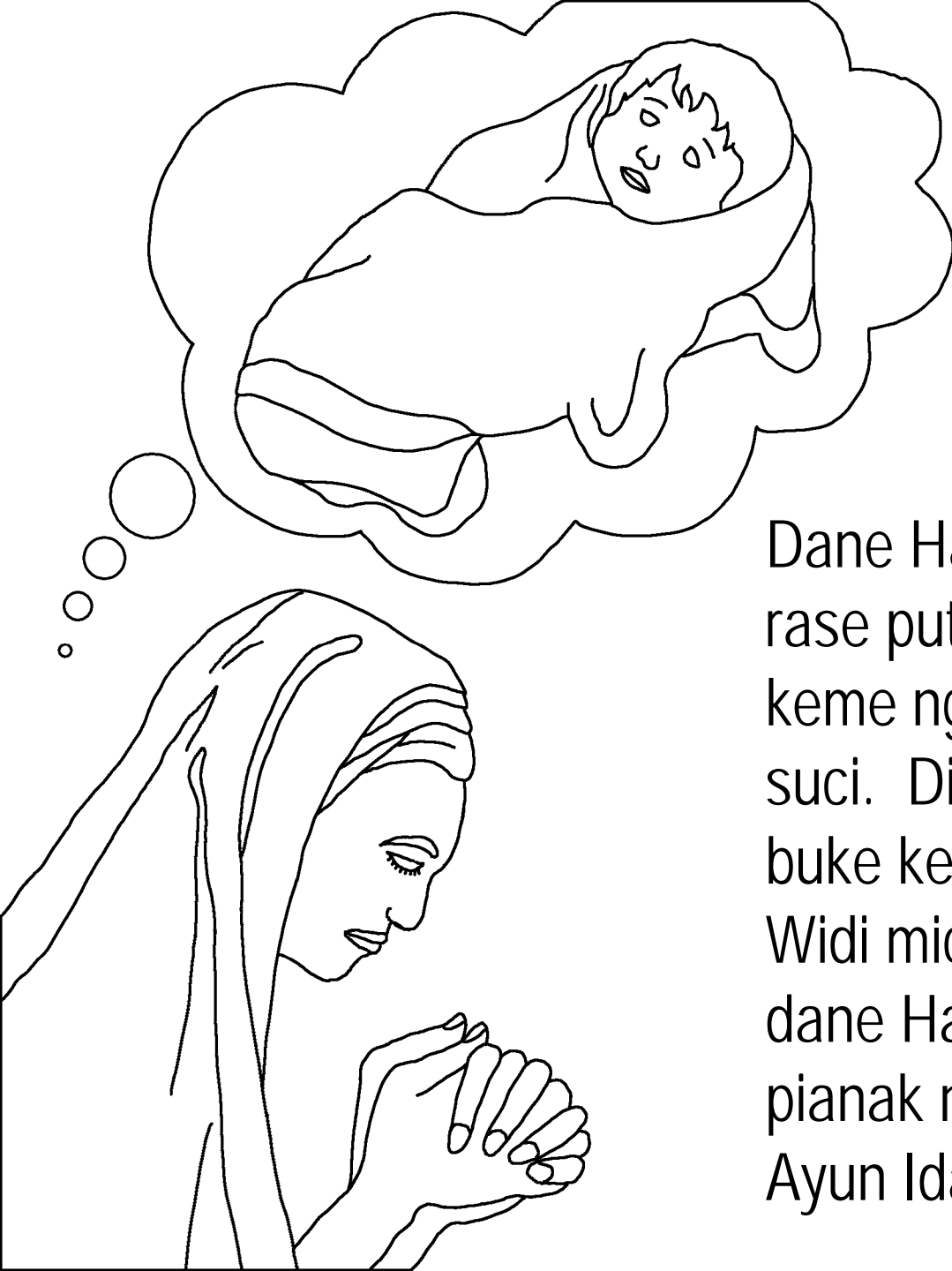

Dane Hanna tusing taen ngelah rase putus asa. Sebilang taun dane keme ngestawa di pure agung bait suci. Ditu dane Hanna mesesangi buke kene, yening Ida Sang Hyang Widi micayang pianak muani tekenin dane Hanna, dane laku nyerah pianak nyane dadi parekan ring Ayun Ida Sang Hyang Widi.



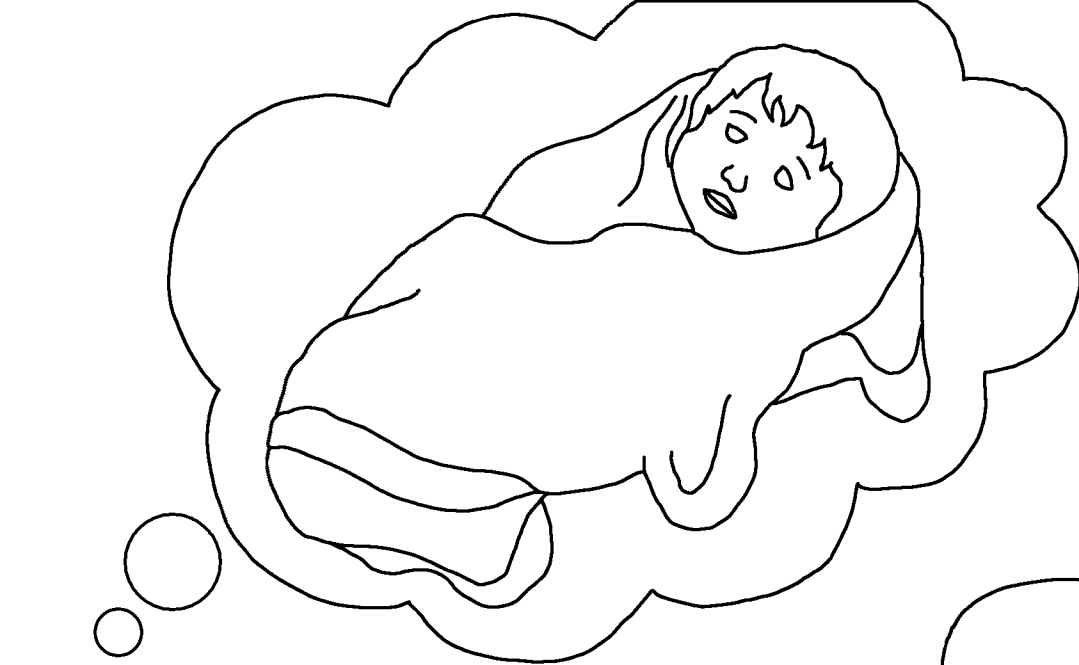

Imam Eli ane sube tua pesan nepuking dane Hanna ngestawa. Imam Eli ningalin bibih dane Hanna komat-kamit, tur tusing ada munyi ane pesu uli bibih nyane, imam Eli ngaden dane Hanna sedekang mabuk uli krane minum anggur. Imam Eli pedih pesan teken dane Hanna.



Dane Hanna lantas matur ring dane Imam Eli, tiang tusing ja sedekang mabuk, nanging tiang ene ngastawa nunas ice ring Ida Sang Hyang Widi apange tiang kicen pianak,



pianak pican Widi ento lakar keserahan dadi parekan ring ayun Ida Hyang Widi. Sesubane Imam Eli mirengang atur dane Hanna, lantas Imam Eli mebaos kene: "Mulih je cening saha rahayu, Ida Hyang Widi lakar ngicen cening ape ane dadi pinunas ceninge". Pangandikan dane Imam Eli ento ngranayang hatin nyane dane Hanna merasa lege pesan.



Ida Sang Hyang Widi Wasa nagingin pengestawan dane Hanna. Dane Hanna lan Elkana kaicen pianak muani, adane Samuel (artine, Kepirengan antuk Ida Sang Hyang Widi) Sakewala apeke ane jani dane Hanna inget tekenin janjin danene ring Ida Sang Hyang Widi?

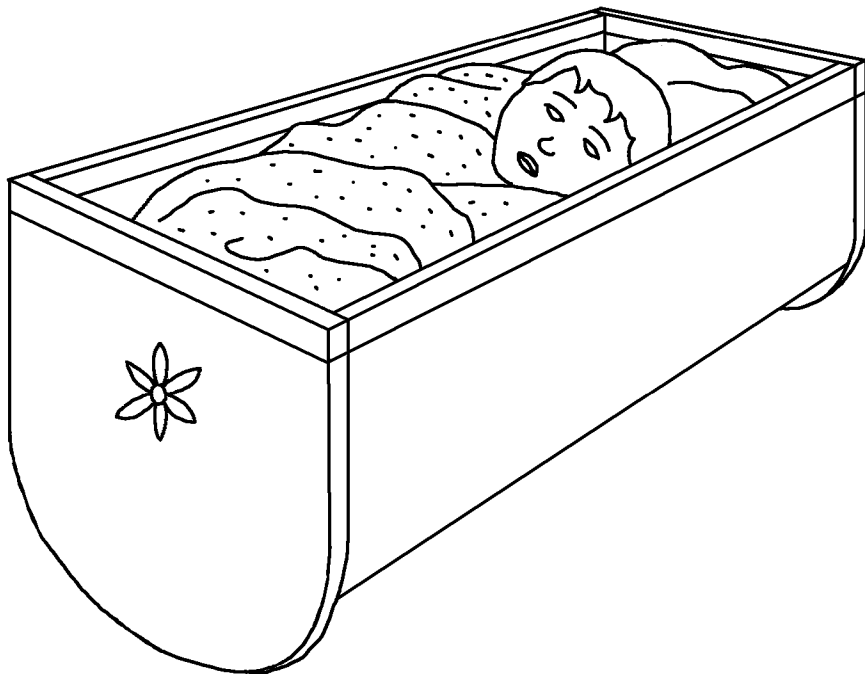



Ane jani, dane Hanna sing je buin ngestawa sebilang tahun ke bait sucine. Ngudiang dadi buke keto? Apeke dane Hanna sube engsap teken janjine ring Ida Ida Hyang Widi? Dane Hanna tusing je engsap. Ane jani dane enu ngurus pianaknyane, yening pianaknyane sube cukup umur lan sube cager nulungin Imam Eli ngayah ring Ayun

Ida Sang Hyang, sinah dane Samuel lakar keserahang ring Ida Sang Hyang Widi, patuh sekadi janjine.





Ida Sang Widi Widi
Wasa ngajiang pesan
kepercayaan dane
Hanna. Sesubane
Samuel lekad, dane
Hanna lantasi buin
ngelah pianak muani
tetelu tur pianak ane luh
dadua. Sabilang tiban
dane Hanna ke pura bait
suci ngaturang bakti lan
ngaba jubah ane anyar,
pegaene padidi lakar
baange buat dane
Samuel.





Dane Samuel tusing je padidian dadi pegayah
dane Imam Eli. Okan-okan dane Eli Hofni lan
Pinehas ditu masi ngaturang ayah. Sakewale
ipun tusing ja jekeh ring Sang Hyang Widi, ipun
melaksana laksanakan ane jaat, sifat-sifatne tusing
nyak mesalin yadian
sube maan piteket uli
dane Eli. Dane imam Eli
pantesne nyuudang ipun
dadi pengayah di
Bait Sucine.



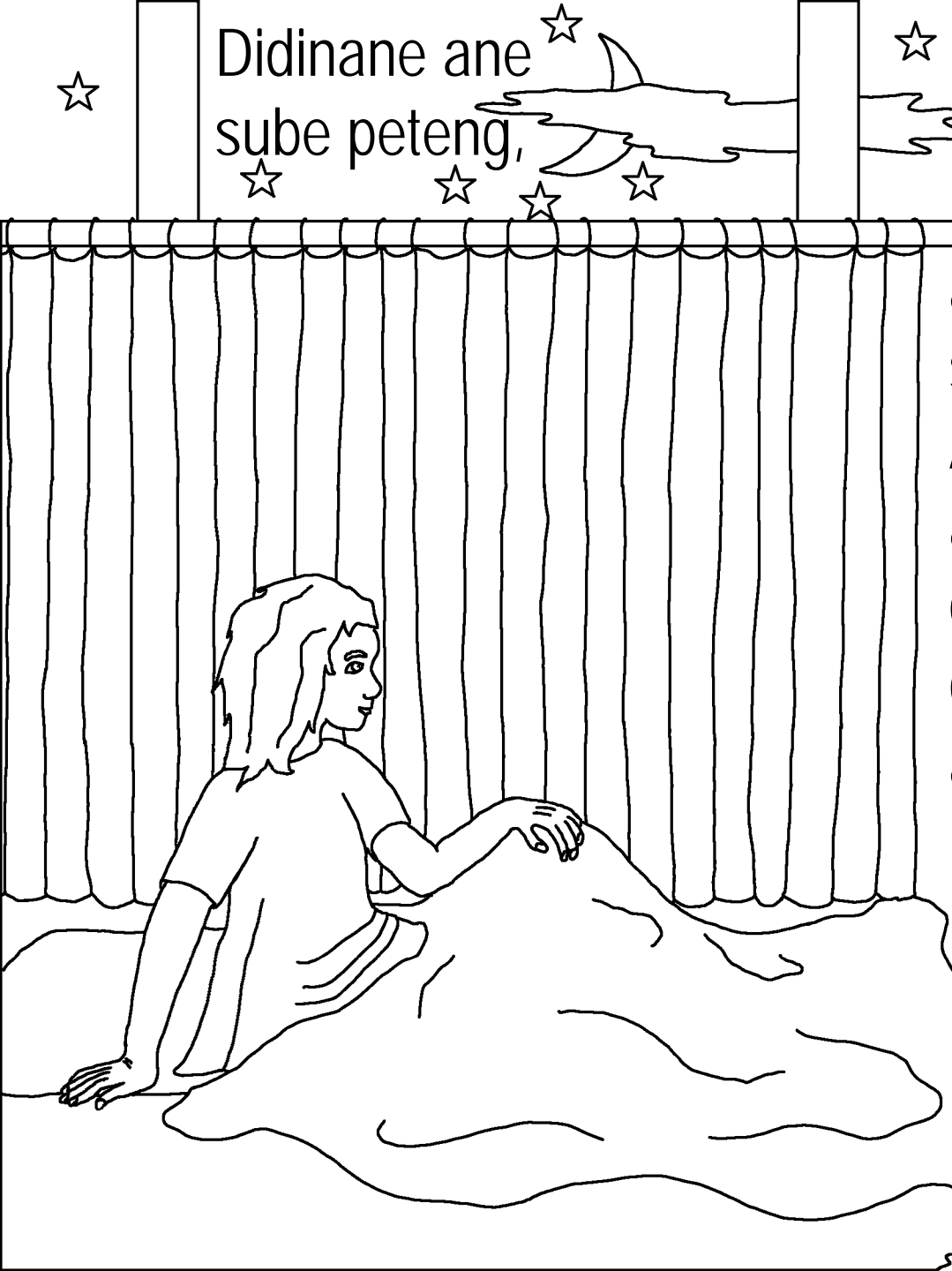

☆ Didinane ane
sube peteng,
☆ ☆ ☆ ☆

☆ dane Samuel ningeh ade
anak ane ngaukin adane.

Samuel ngaden ane ngaukin
adan danene tusing je lenan,
sinah sube dane imam Eli.
Atur danene "Inggih, titiang
aji," "Aji tusing ade ngaukin
cening". Pangandikan
dane imam Eli. Paundukan
ane patuh buke keto
kedingehang kanti ping telu.

Ditu lantas dane Eli sadar,
sujatine Ida Sang Hyang
Widi meled pesan lakar
mebaosan marep ring
dane Samuel.



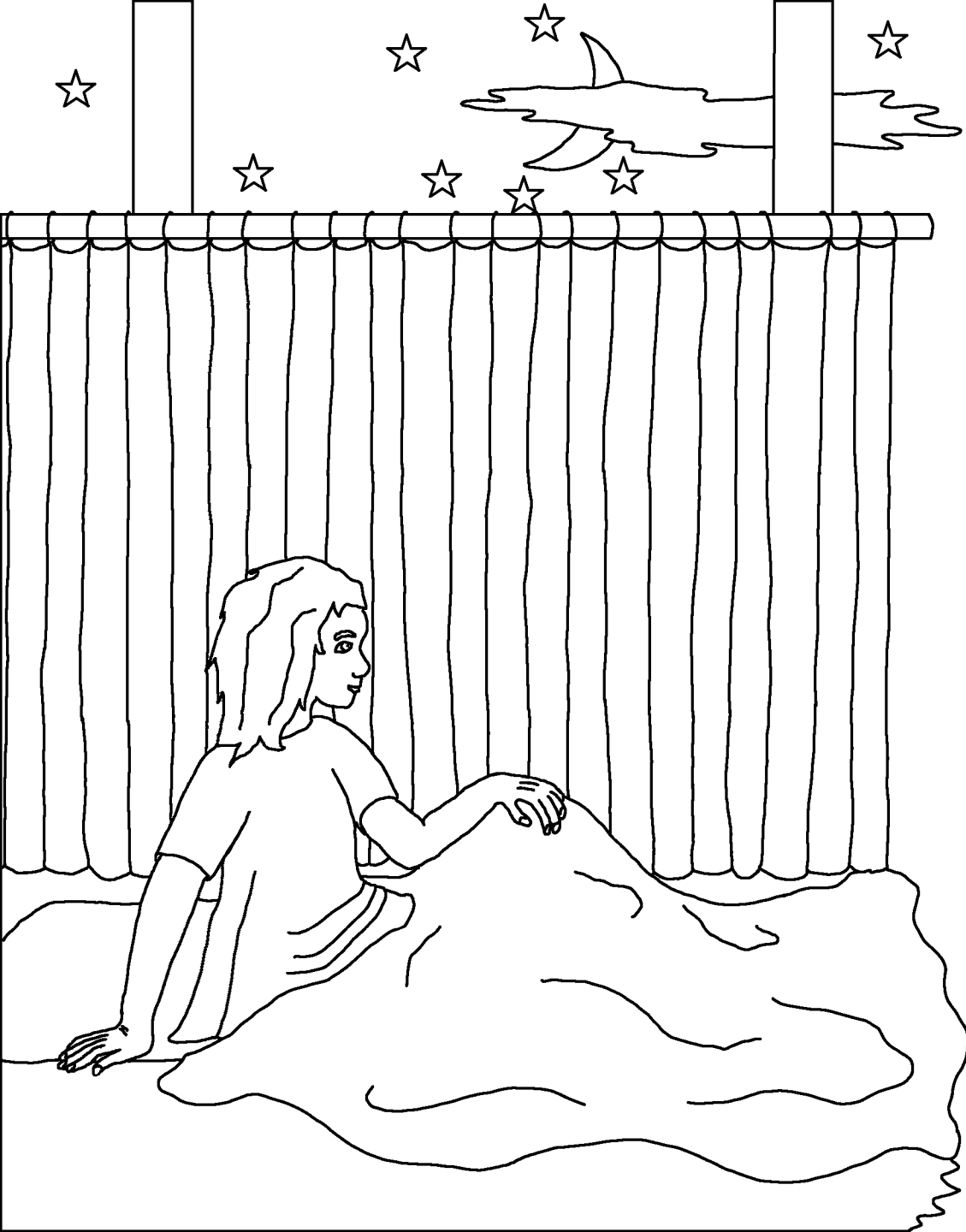

Pangandikan dane Imam Eli tekenin dane Samuel, "Yening Ida Sang Hyang Widi Wasa ngesengin cening buka ibusan, kene abete matur, Inggih Ratu, rarisang masabda, duaning titiang kaulan druwene sedia jagi miragiang!" Ida Sang Hyang Widi Wasa raris mesabda ring dane Samuel tur ngicen dane bebesen ane penting.



Sesubane semengan, dane imam Eli ngesengin dane Samuel, tumuli metakon buke kene, "Apa ane kesabdayang baan Ida Sang Hyang Widi Wasa teken cening?" Ditu lantasi dane Samuel nuturang makejang, ape ane sube kasabdayang Ida Sang Hyang Widi ring dane. Bebesen Ida Sang Hyang Widi serem pesan, Ida Sang Hyang Widi lakar ngicen hukuman marep ring keluargan imam Eli uli krane parisolah Hofni lan Pinehas jaat pesan.



Sabdan Ida Hyang Widi kelaksanayang. Bangsa Israel meperang ngelawan bangsa Filistin, okan-okan dane imam Eli ane jaat ento dadi pemimpin perang sambilange negen tabut perjanjian di arepan tentara Israele. Tabut perjanjian lantasi kerampas olih bangsa Filistine tur ngematiang Hofni lan Pinehas, keto masi wong Israel ane milu meperang. Ritatkala dane imam Eli mirengan kabare ento, dane lantasi ulung uli tongosne negak, boongne lung, dane masi mati didinane ane patuh ajak kematian okan-okan danene.



Tabut perjanjian Ida Sang Hyang Widi kranayang bangsa Filistin liu ngelah masalah. Tabut perjanjiane tongosange di kuil Dagone. Di dine semengane, togog dagone ulung ketanahe. Wong Filistine lantasi ningtingan togoge ento, sakewala buin manine togoge ento buin ulung, kanti benyah enyag.

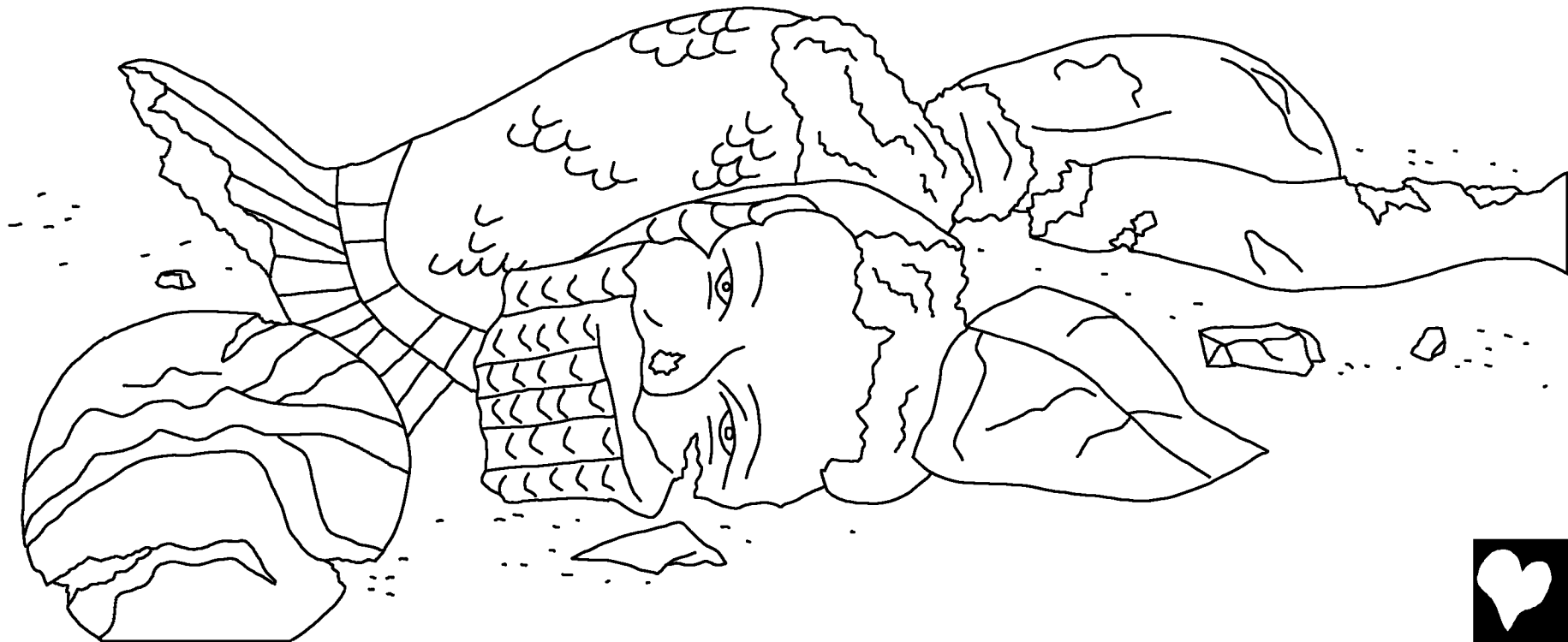

Sakit penyakit
lan kematian
menyebar di

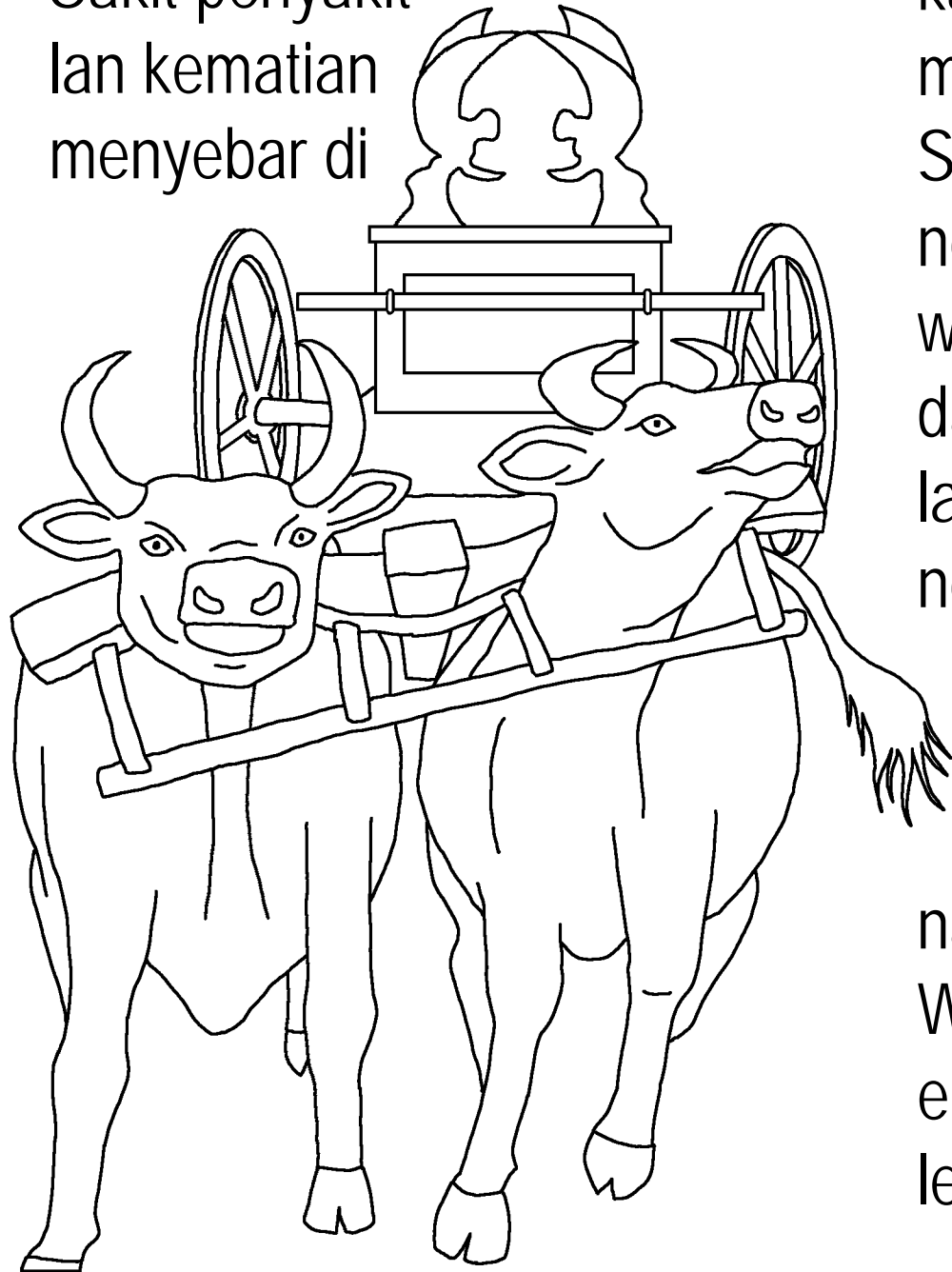

kalangan wong Filistine. Apange
maan kepastian, apeke sajan Ida
Sang Hyang Widi Wasa ane
ngemang hukuman ento, lantane
wong Filistin nyemak lembu sapi
dadua ane sedeng ngenyonyonin
lantane pasange di keretane. Ia
ngejang tabut perjanjianne ento
duurne. “Yening lembune ento
nuju ke Israel tur ngutang
panak-panakne, irage lakar
nawang sujatine Ida Sang Hyang
Widi ane ngelaksanayang
ento makejang.” Nah
lembu-lembune ento megedi!



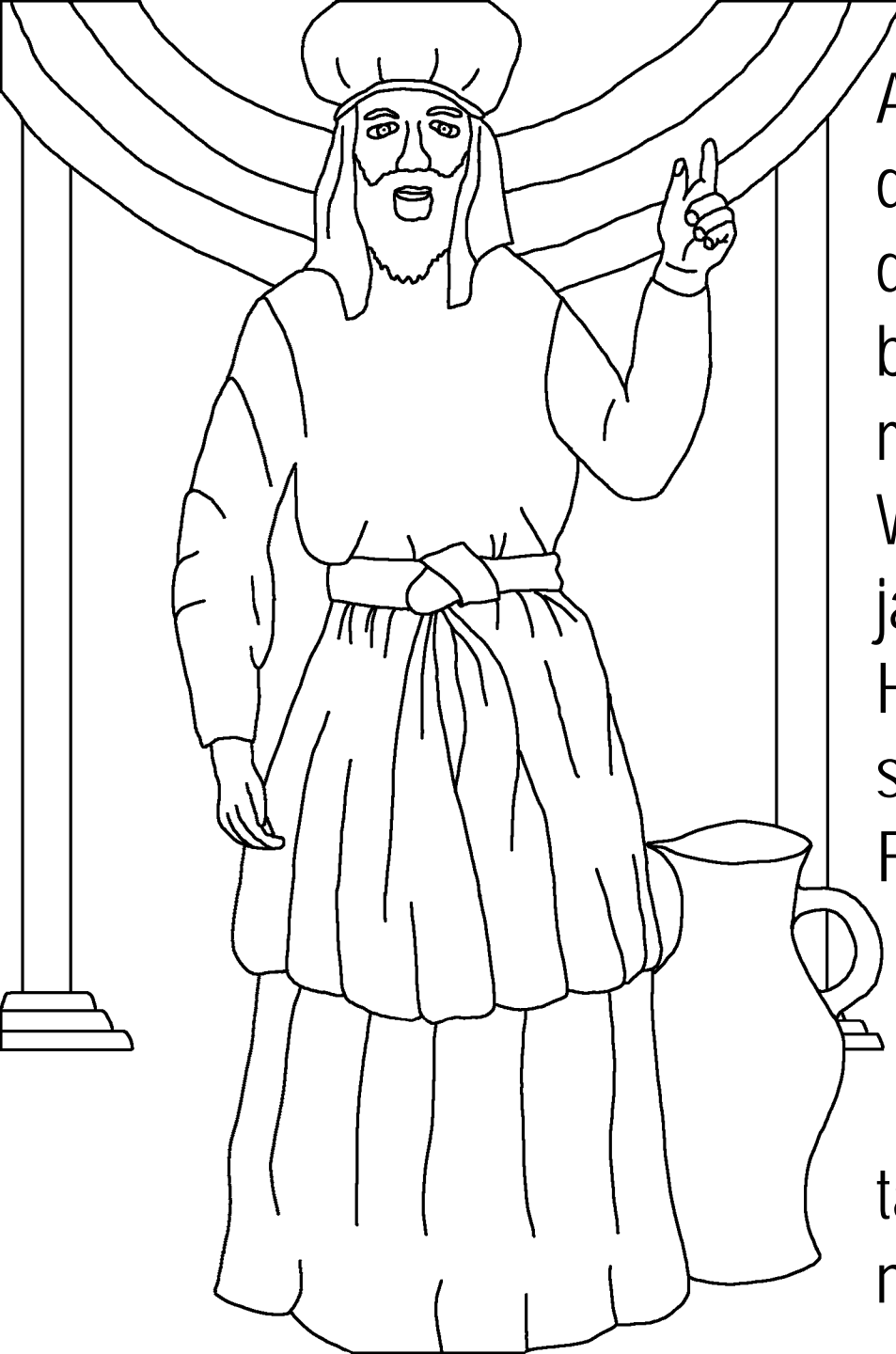

Ane jani dane Samuel, sube menek duur, dadi anak muani ane truna, dane raris mewacana marep ring bangsa Israele. "Yening jerone mewali ring ayun Ida Sang Hyang Widi saking nekeng hati, edohang ja ... sinah sube tangan Ida Sang Hyang Widi laku ngelempasan semeton uli tangan bangsa Filistine." Makejang wong Israel jeg nyak taat ngelaksanayang pengidih dane Samuel, kaulan Ida Sang Hyang. Ditu lantastangan Ida Sang Hyang sane ngelawan bangsa Filistine.



Samuel, Parekan Ida Hyang Widi

Wenten katuturan carita saking pengandika Ida sang Hyang
widi mewasta Alkitab,

dados sobyahang ring

1 Samuel 1-7

"Pemargin saking pengandika Ida Ngicenin Karahayuan."

Mazmur 119:130



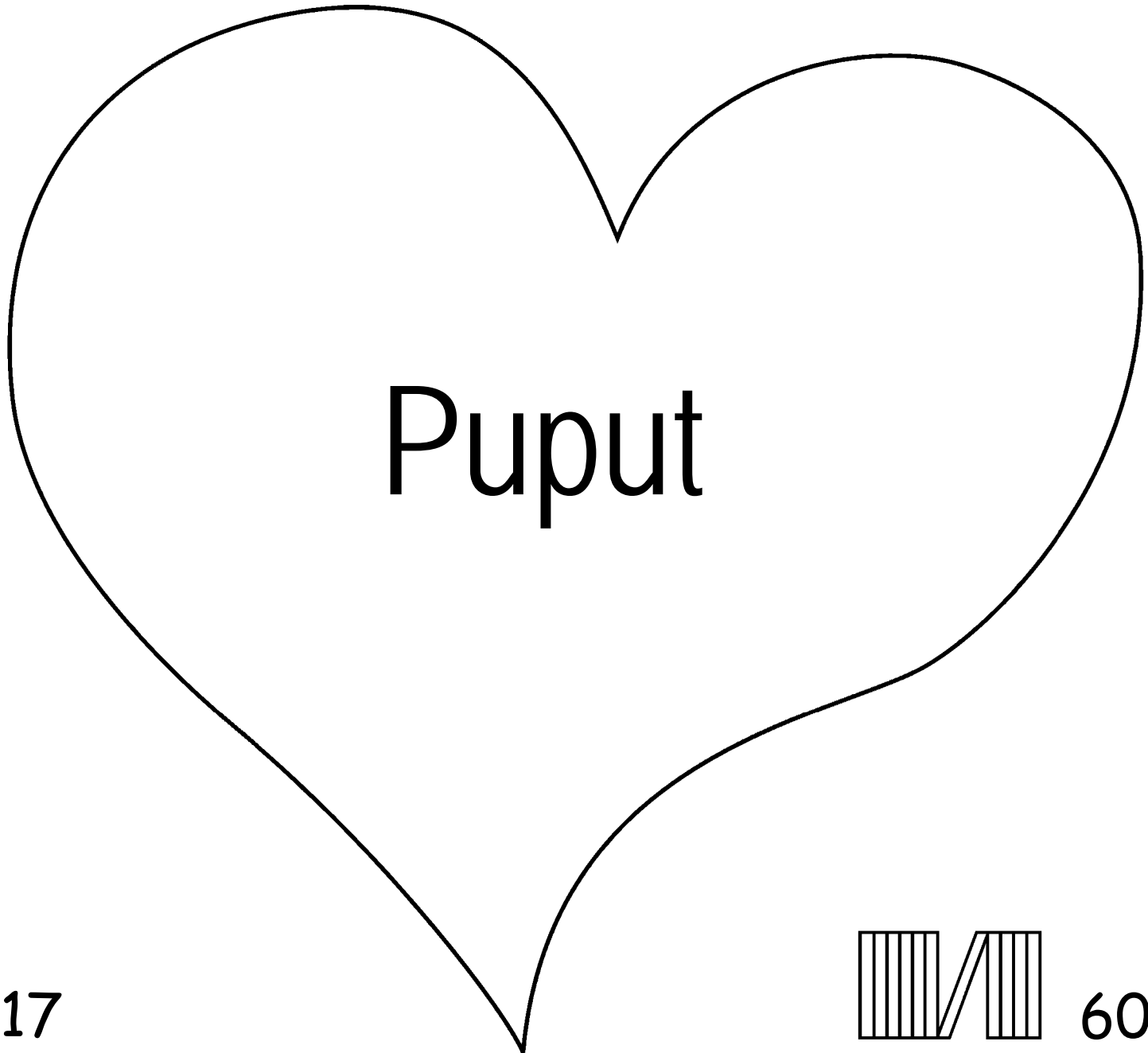

17

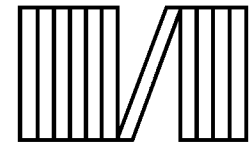

60



Carita ring Alkitab puniki nyaritayang indik Ida Hyang Widhi mahotama sane ngripta iragane tur sane mapikayun iraga nguningin Ida.

Ida Hyang Whidi uning iraga sampun melaksana sane iwang, sane kaucap antuk papa. Papongoran antuk jadmā sane melaksana papa inggih punika lepas utawi padem, sakewanten Ida Hyang Whidi dahat sutresna. Ida raris ngutus okan Idane sane meraga tunggal, sane mapesengan Ida Hyang Yesus Kristus, mangda Ida lepas ring taru Salib tur kapongor sangkaning kaiwangan iragane. Ida Hyang Yesus urip malih tur mantuk ka Suarga loka! Yening ragane pracaya indik Ida Hyang Yesus tur mapinunas mangda Ida ngicenin pangampura antuk keiwangan-kaiwangan iragane, Ida jagi nglaksanayang! Ida jagi rauh tur meneng ring sejeroning pareragan ragane sane mangkin, tur ragane jagi nyeneng sareng Ida ngantos riwekasan.

Yening ragane pracaya indik kepatutan punika, nikaang puniki ring Ida Hyang Widhi: Ida Hyang Yesus, tityang pracaya pareragan Idane sawiakti Ida Hyang Parama Kawi, nanging Ida nyeneng dados manusa sane lepas santukan nebasin kaiwangan iragane, tur sane mangkin Ida pacang urip malih. Dumogi Ida rauh ring kauripan iragane lan ngicen pangampura antuk keiwangan iraga makesami, sane ngawinang irage madue keuripan sane anyar tur buin pidan irage pacang meraga siki sareng Ida. Wantu tityang satinut sareng titah Idane tur idup daos pianak Ida, Amin.

Ngiring ngewacen Alkitab tur mapitatur sareng Ida Hyang Widhi ngerahina! Yohanes 3:16

