

# Alkitab Anggen Anak Alit

Dane Yunus lan  
Be Ane Gede



Kasurat olih: Edward Hughes

Kaperagayang olih: Jonathan Hay  
Alastair Paterson

Ka tempa saking: Mary-Anne S.

Ka dwi aksarayang olih: Ni Luh Mastri Ayu Caerina;  
Pdt I Gusti Made Alit Purya

Kakaryanin olih: Bible for Children  
[www.M1914.org](http://www.M1914.org)

©2024 Bible for Children, Inc.

Perarem: Ida dane dados nerjemahang utawi nyalin carita puniki,  
nanging nenten dados ke adol.



Dugas ipidan, di Israel ada anak muani ane  
madan Yunus. Sedek dina anu, Ida Sang Hyang  
Widi ngorahin dane Yunus berangkat ke  
Ninewe, kotane ane paling  
gedene lan ane paling  
rame di jagate  
dugase ento.

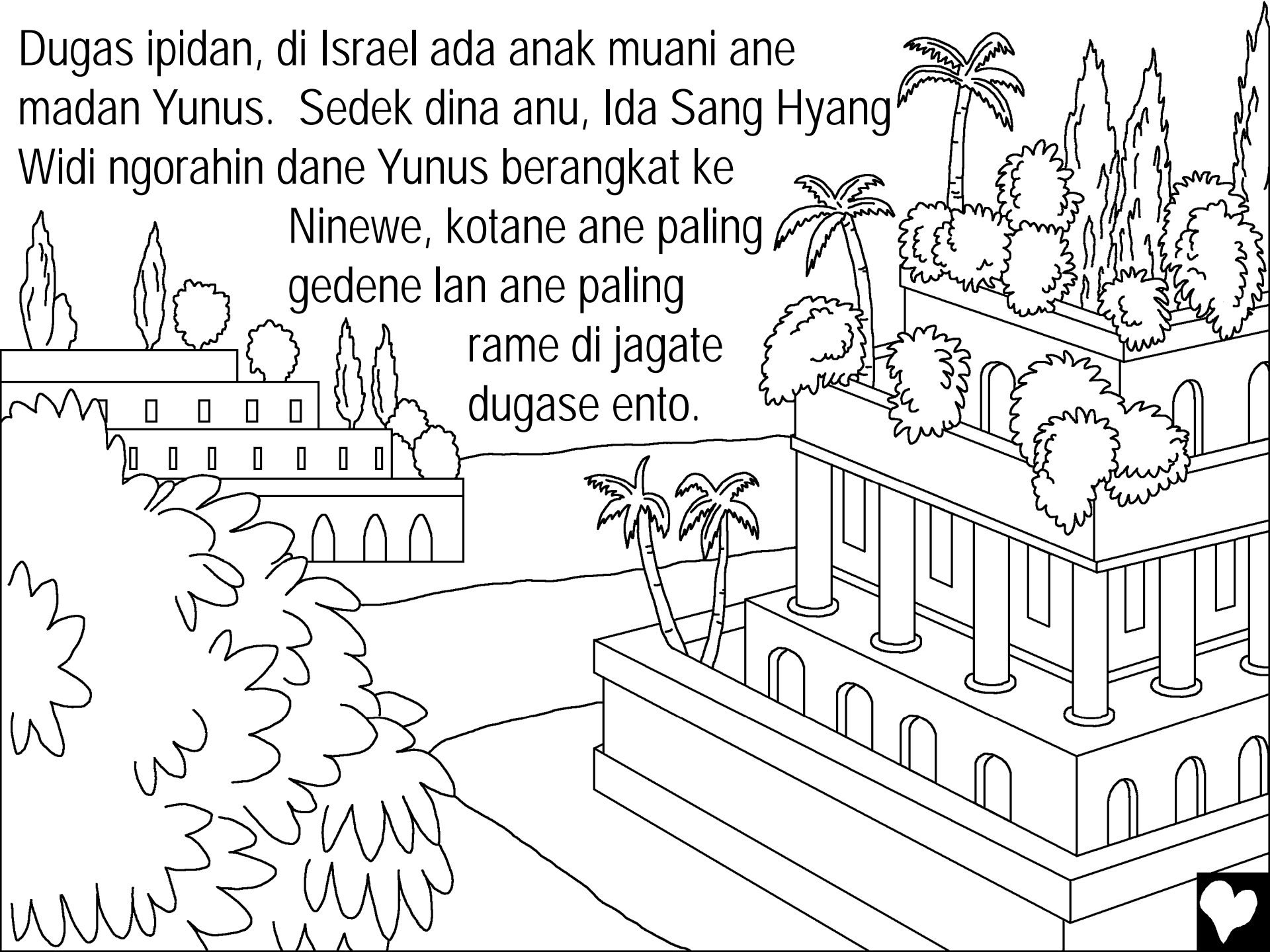

Dane Yunus ngorahin anak ane ada di kotane  
ento, sujatine Ida Sang Hyang Widi nawang  
makejang dosa-dosa ane suba kelakonin  
penduduk kota ento.

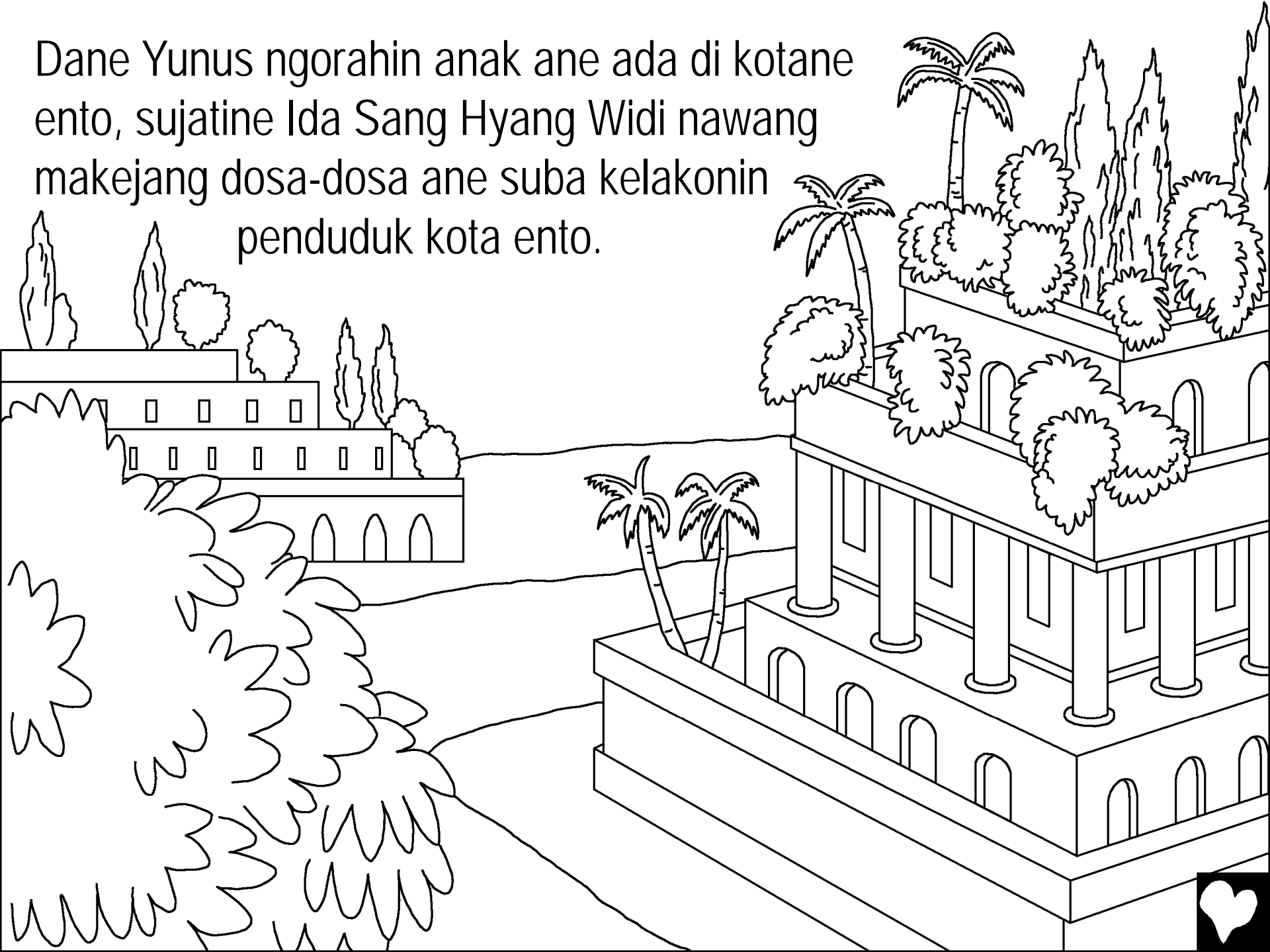

Sakewala dane Yunus sing nyak nuutin  
prentah Ida Sang Hyang Widi. Ia sing ja  
berangkat ke Ninewe, ia malah numpang  
kapal ane berangkat ke Tarsus.



Ida Sang Hyang Widi Wasa lantias ngadakang angin topan di tengah pasihe. Makejang anak ane ada di kapale, ane tumpangin dane Yunus pada takut kapale ento usak lan kelem.

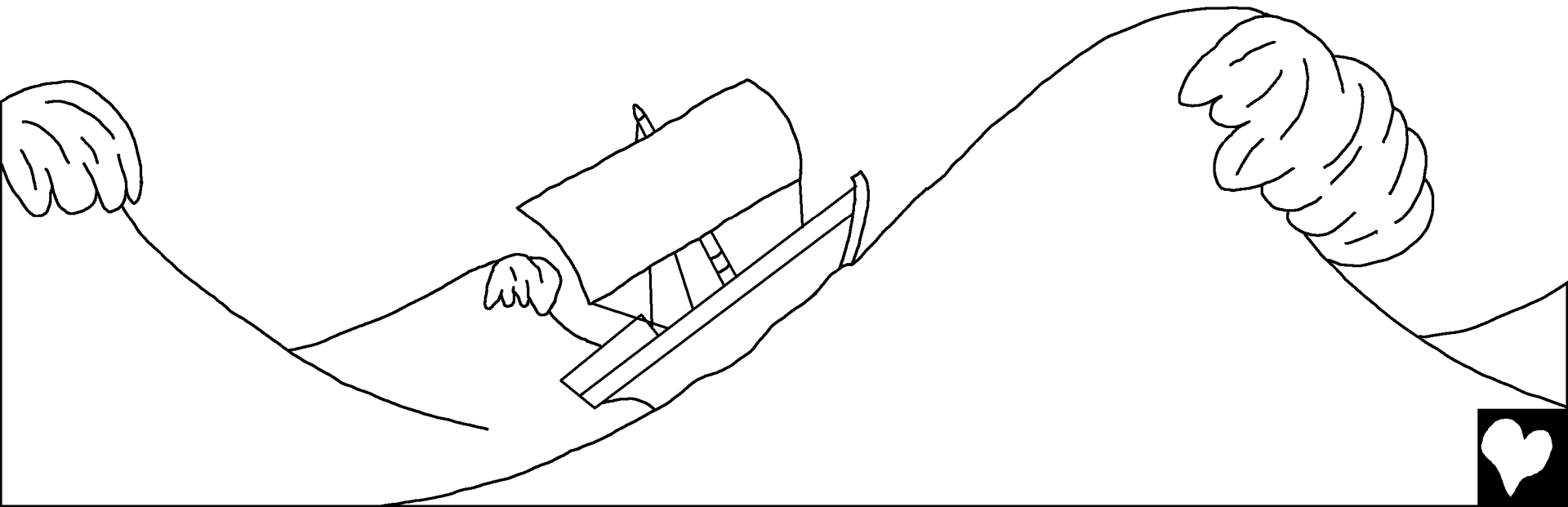

Angin nglinus sayan ngedenan lan baret pesan. Makejang penumpang kapale takut, lan ngastawa nunas tulung teken dewa-dewane. Barang-barang ane ada di kapale ento entungange ka pasihe. Sakewala kapale ento tetep dogen tusing nyidang melayar.



Tuah dane Yunus ane ada di kapale ane sing milu ngestawa. Ia malah pules di dek kapale ane paling sebeten. Nahkoda kapale ngalih dane Yunus. "Eh jero ... ngudiang jero dini? Pules? Enggalin bangun ... ! Enggalan ngestawa ring Ida Sang Hyang Widi. Dumadak ja Widin jerone nresnain tur nulungin iraga, apange iraga luput uli baya ane lakar nyengkalin iraga."

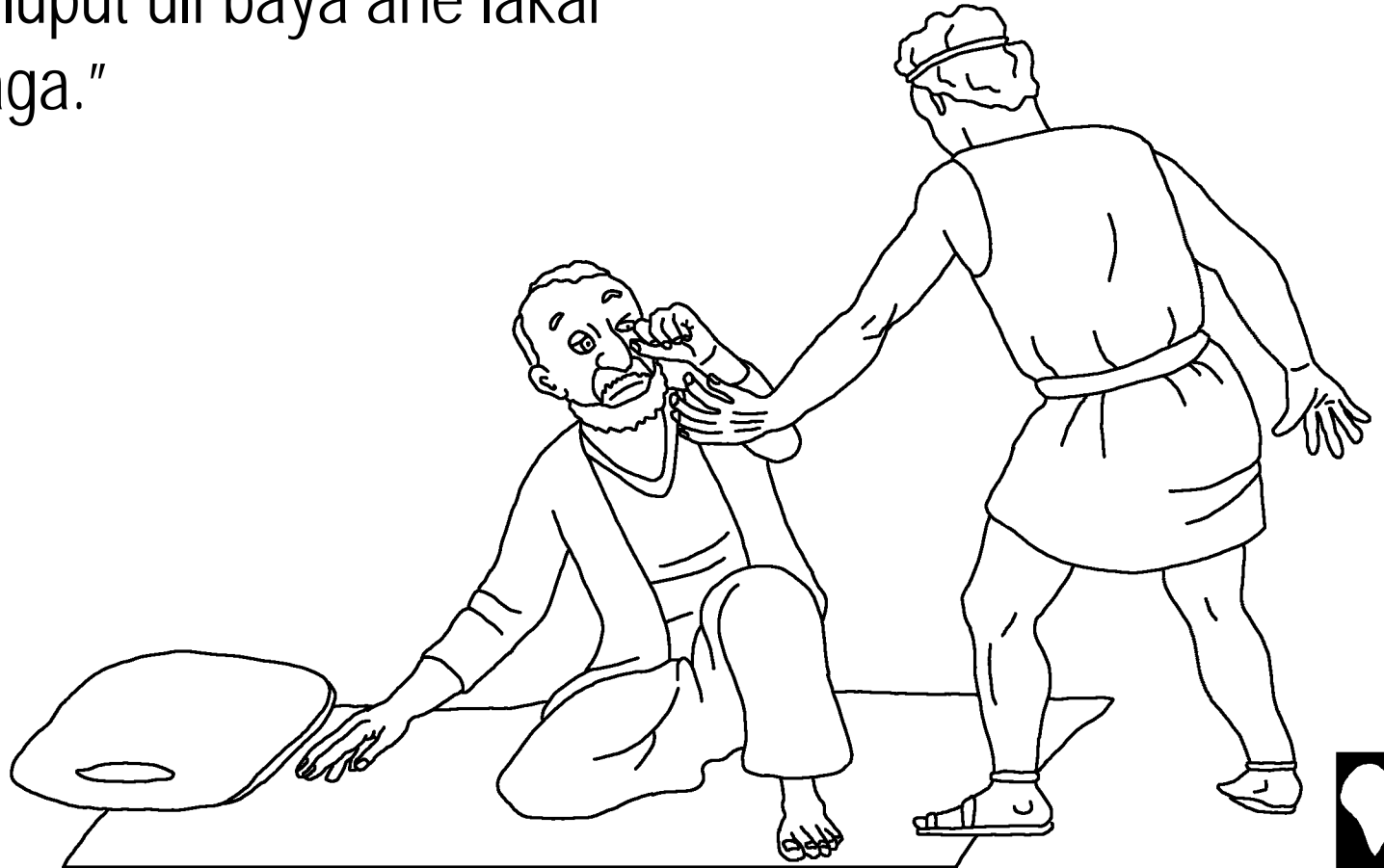



Makejang penumpang kapale nuduh dane Yunus ane ngranang kapale keserang angin nglinus ane baret. Ditu lantas Yunus nuturang sujatine ia sing nyak nuutin prentah Ida Sang Hyang Widi. Lantas penumpang kapale ento metakon kene, "Ane jani apa mirib ane pantes laksanayang tiang buat semeton apange angin nglinus ene nyak rered?" Pesaut dane Yunus, "Entungang ja tiang ka pasihe! Uli krana ... tiang". Tiang percaya, dosan tiange ane ngranayang angin

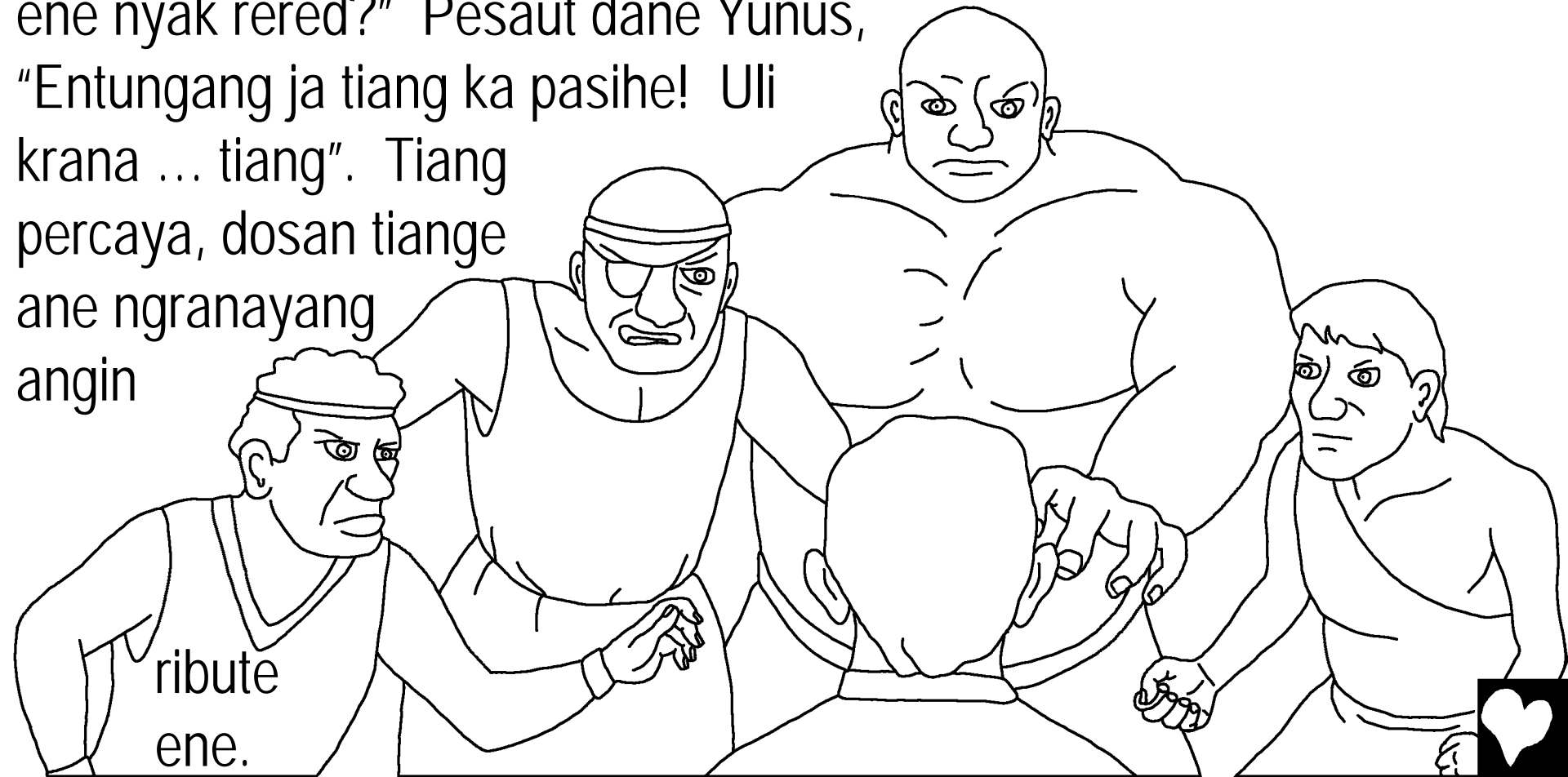

Makejang pegawai kapale  
sing nyak ngentungan  
Yunus ka pasihe. Lantas ia  
terus nayung kapale ento  
kuat-kuat apange nyidang  
teked di pesis. Sakewala  
ia sing masi nyidang.  
Tuah nu ada besik  
jalan buat  
nyelametang  
kapale.

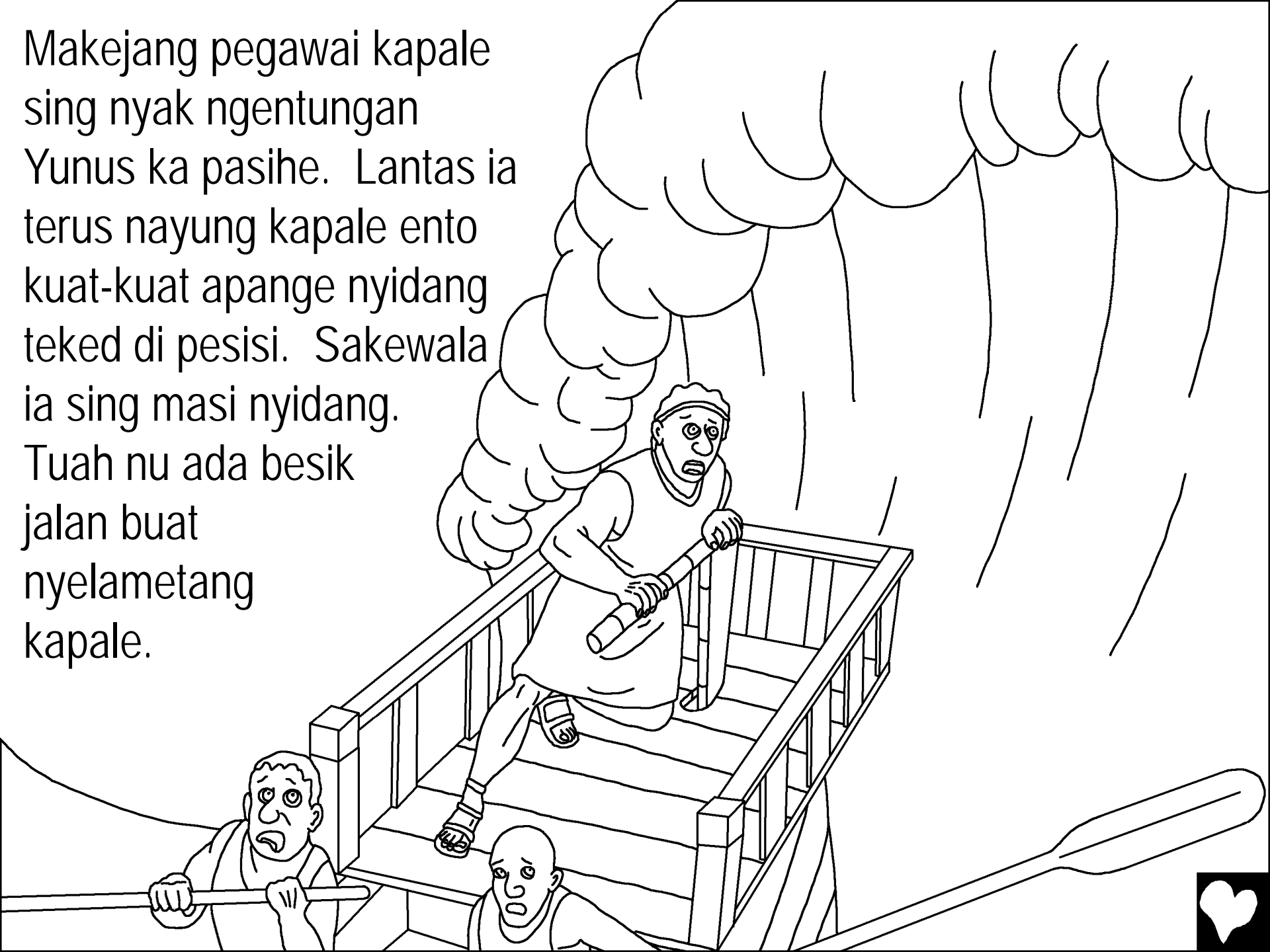

Sesubane dane Yunus suud ngestawa nunas  
pengampunan,  
para pegawai  
kapale  
ngentungan dane  
Yunus ka pasihe.

Rikala dane Yunus kelem, jeg  
saget ombak yeh pasihe nadak rered.  
Cuacane nadi bagus pesan, unduke  
ento ngranayang makejang para  
pegawai kapale pada takut,  
lebihan takutne yen bandingan  
teken ombak gede ane  
mara sajan rered.

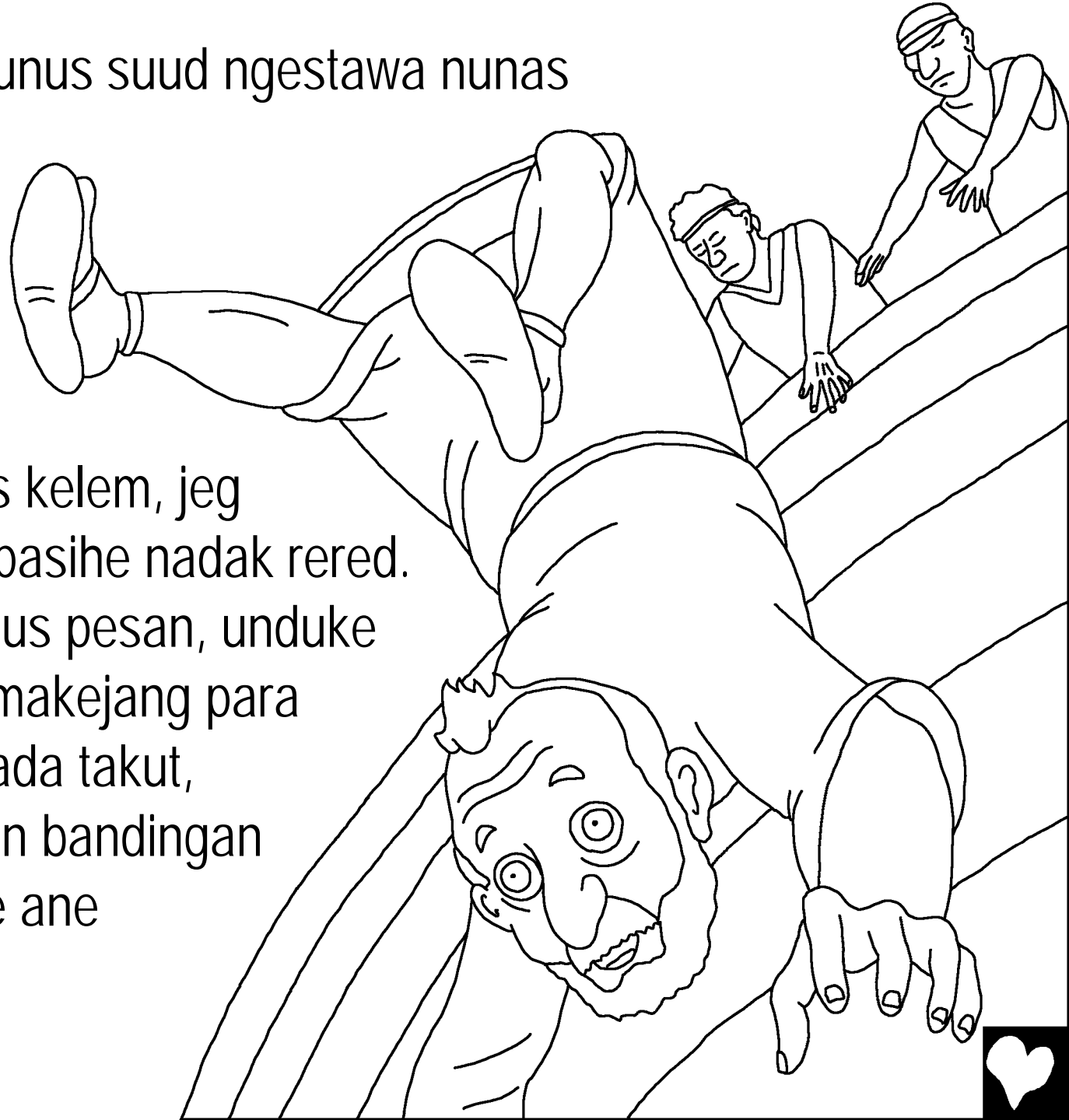

Makejang ia sadar  
tuah Ida Sang  
Hyang Widi  
ane nyidang  
ngadakan  
unduke ento.  
Di tengah rasa  
takut lan heran,  
lantas ia memuji  
ngaluwihang parab  
Ida Sang Hyang  
Widi.

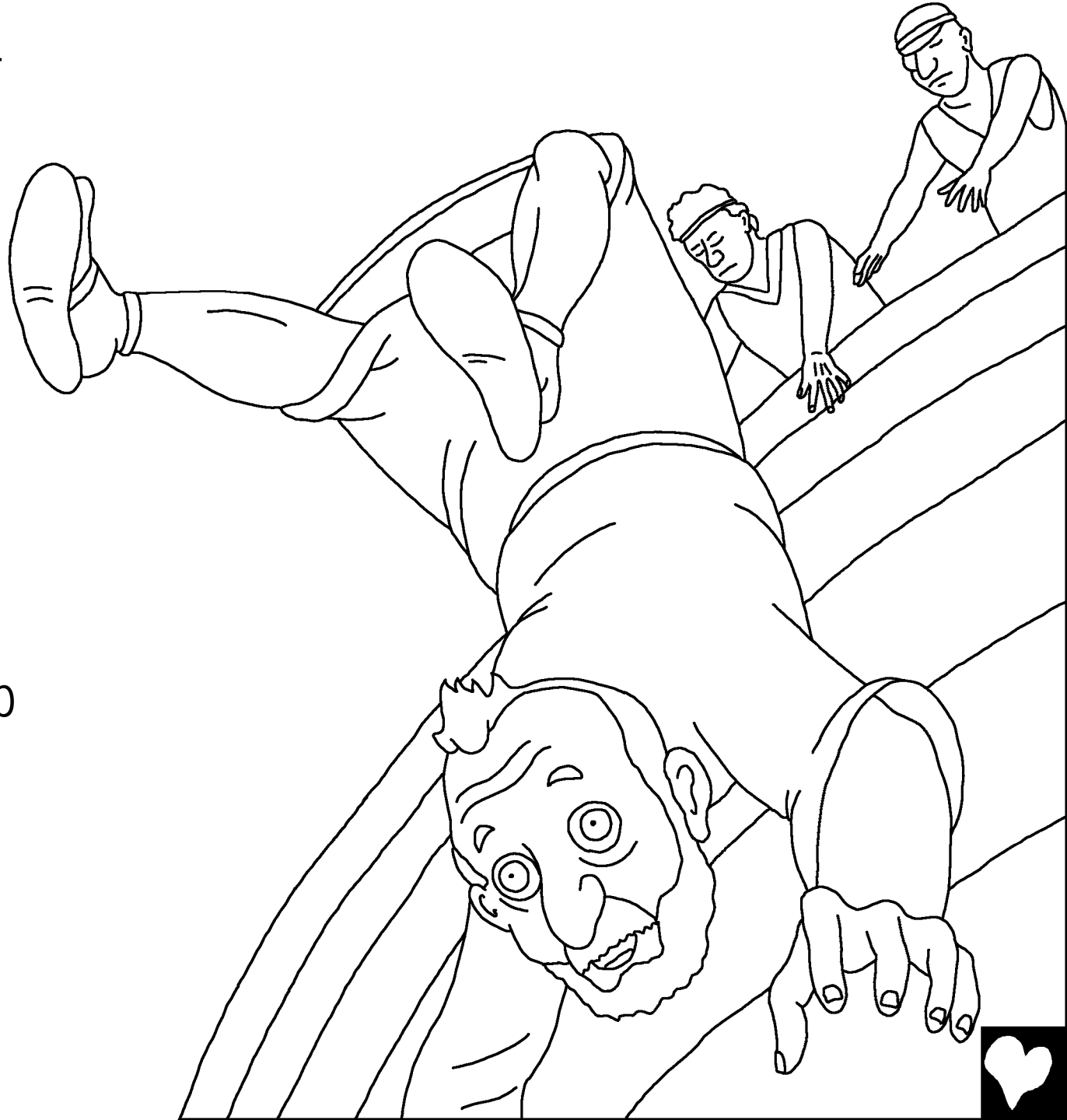

Di kala ento, anak ane dadi utusan (Yunus) sing nyak ngelaksanayang prentah Ida Sang Hyang Widi maan ka ajaiban. Di tengah pasihe ane dalem dane Yunus sing ngelah harapan idup uli krana ia ngaden sing lakar ada anak ane nyidang nulungin. Ia lakar mati di pasihe, sakewala Ida Sang Hyang Widi ngelah rencana-rencana lenan buat Yunus.

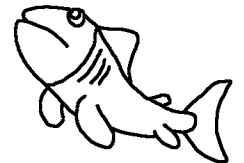
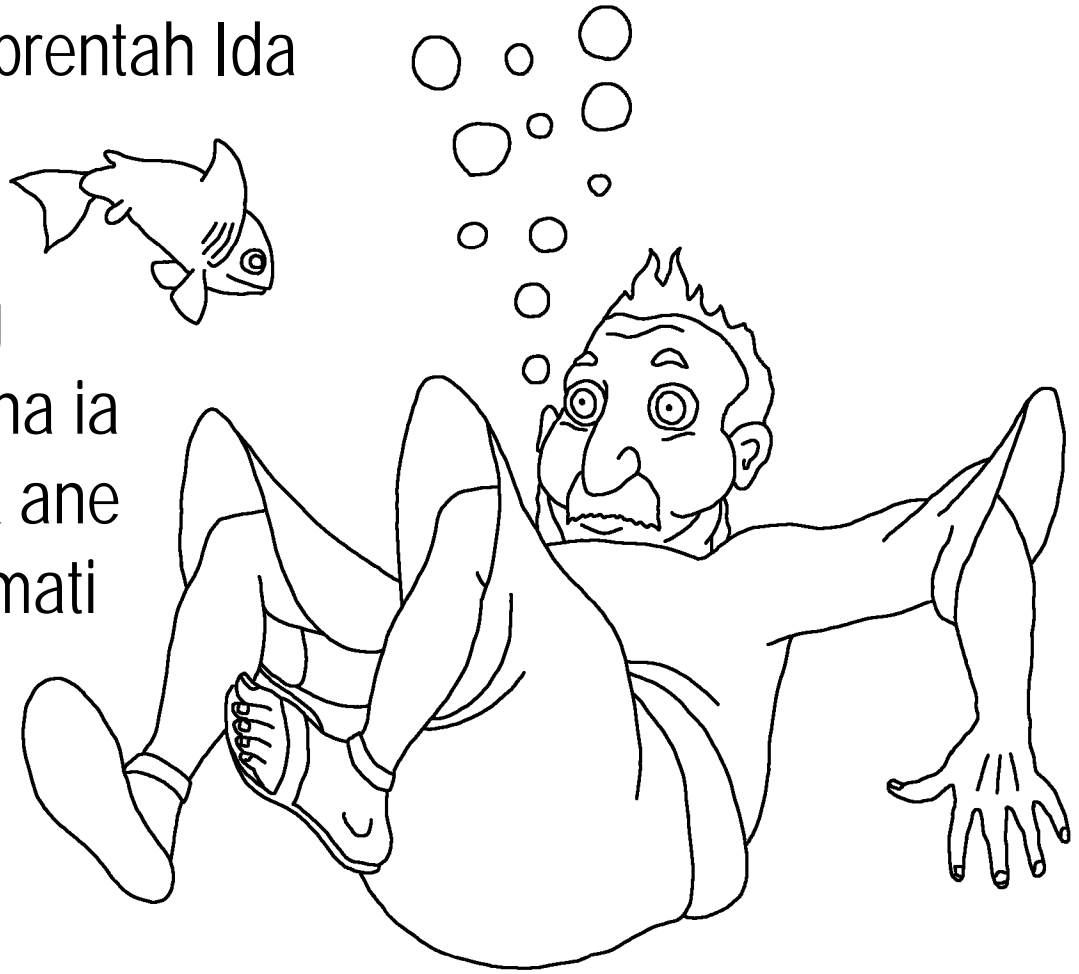

Ida Sang Hyang Widi suba nyediang be ane gede ukud buat nyaplok tur nguluh dane Yunus. Be ane gede ento jeg teka di kala ane tepat! Rikala be ne ento nyaplok tur nguluh dane Yunus, ia langsung ada di tengah basang be ne, telung wai mekelone. Ditu dane liu ngelah waktu buat merenung lan ngastawa.



Sesubane telung wai di tengah basang be ne, dane Yunus majanji lakar ngelaksanayang prentah Widine. Ida Sang Hyang widi lantasmrentahang be ne ento ngutahang Yunus di sisin pasihe.

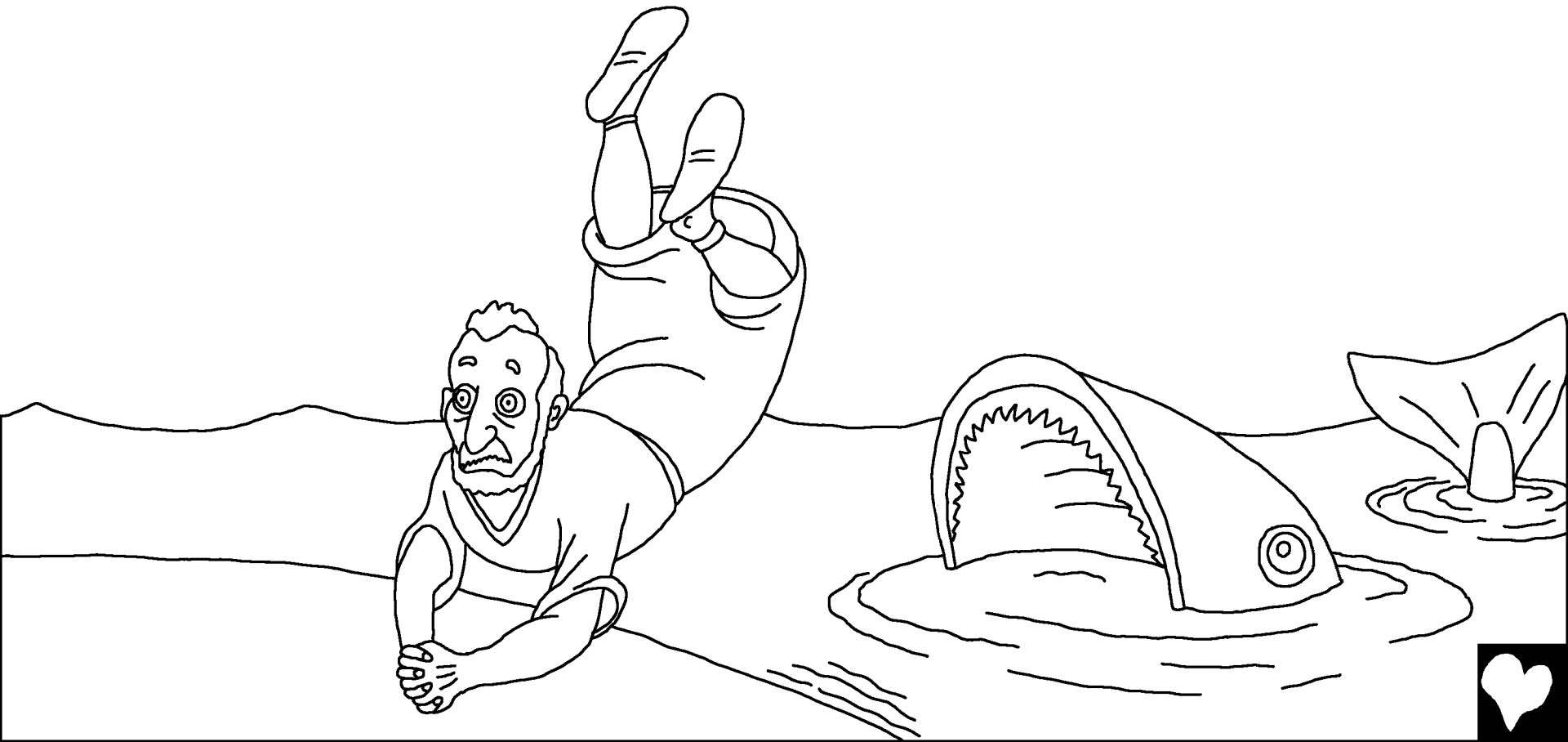

Ida Sang Hyang Widi buin cepok mrentahang apange Yunus berangkat ka Ninewe buat ngajahin anak ane ada ditu, sabdan Ida Sang Hyang Widi. Nah ane jani dane Yunus taat, dane langsung berangkat ka Niniwe. Di kala Yunus neked di kota Niniwe lan ngewarahang "tuah buin petang dasa dina, kota Niniwe ne lakar ka uwugan".





Makejang penduduk Niniwe percaya ring pakeling Ida Sang Hyang Widi. Ia ajake makejang sing medaar lan ia nganggo penganggo ane biasa anggota berkabung buat nunas pengampura ring Ida Sang Hyang Widi. Sang prabu bangsa Niniwene masi ngasorang dewek ring arepang Ida Sang Hyang Widi. Dane ngembus mahkota danene, nganggon penganggo anak berkabung, lan negak di tanah ane bek misi abu. Sang prabu mrentahang apange makejang rakyatne ngutang dosa-dosane lan ngastawa, uli krana ipun percaya Ida Sang Hyang Widi

lakar ngampurayang  
dosan-dosane.

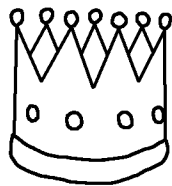

Ida Sang Hyang Widi mapica pengampunan buat bangsa Niniwe.  
Nah ento dinane ane paling ngeliangin buat penduduk Niniwe, dina  
rikala dosan-dosane kaampurayang

oli Ida Sang  
Hyang Widi.  
Sakewala ada  
anak adiri ane  
gedeg pesan  
basang ne.  
Yunus!



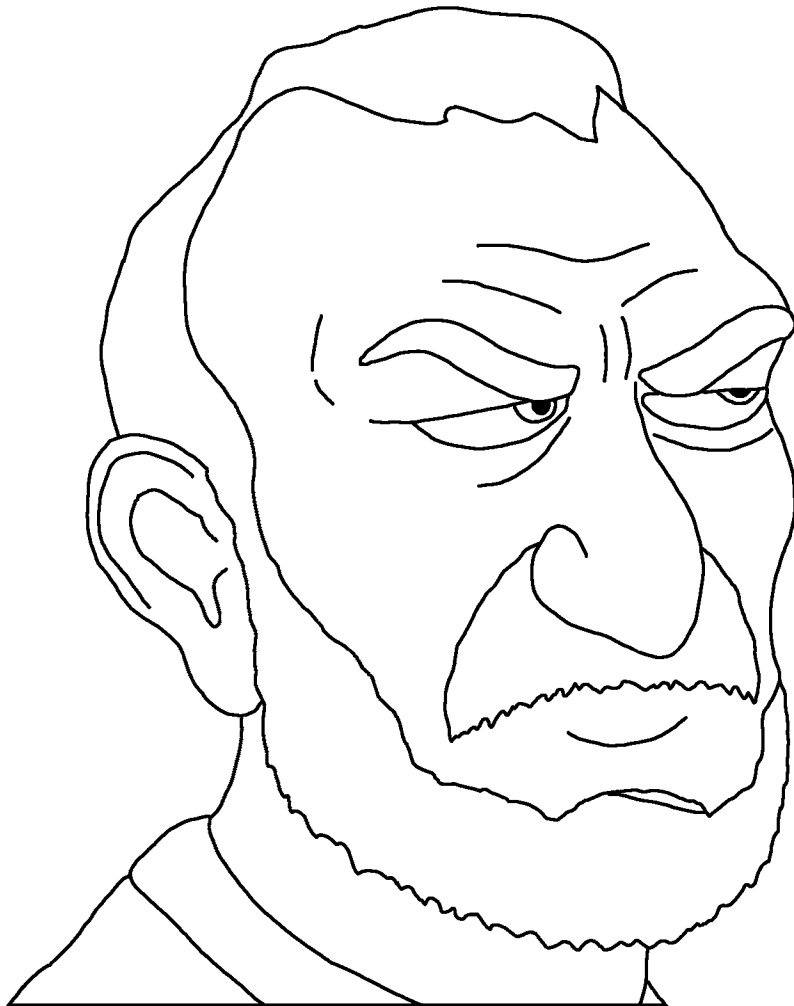

Ngudiang dadi dane Yunus memedih? Dane matur ring Ida Sang Hyang Widi, "Tiang nawang palungguh I Ratu Widi sane olas asih, tusing gampang pedih lan maraga becik." Wiadin, dane Yunus sadar Ida Sang Hyang Widi lakar micayang pengampunan buat anak ane mapinunas pengampunan ring Ida, yening ia pada kapok tur taat ring sabdan Ida Sang Hyang Widi. Rasane dane Yunus sing ja ngarepang Ida Sang Hyang Widi mapica pengampunan buat bangsa Niniwene.



Dane Yunus pedih pesan ring Ida Sang Hyang Widi lan dane matur buka kene, "Bancut ja idup tiange; luwungan suba tiang mati ketimbang tiang nu idup."



Dane Yunus ngalih tongos negak di pinggiran kotane sambilange ngantosang apa ane lakar kalaksanayang antuk Ida Sang Hyang Widi. Ida Sang Hyang Widi nyediang punyan jarak ane don ne gede-gede. Punyan jarake ento enggal pesan tegeh, cocok anggon tongos metis buat dane Yunus rikala matan aine panas nraktak.

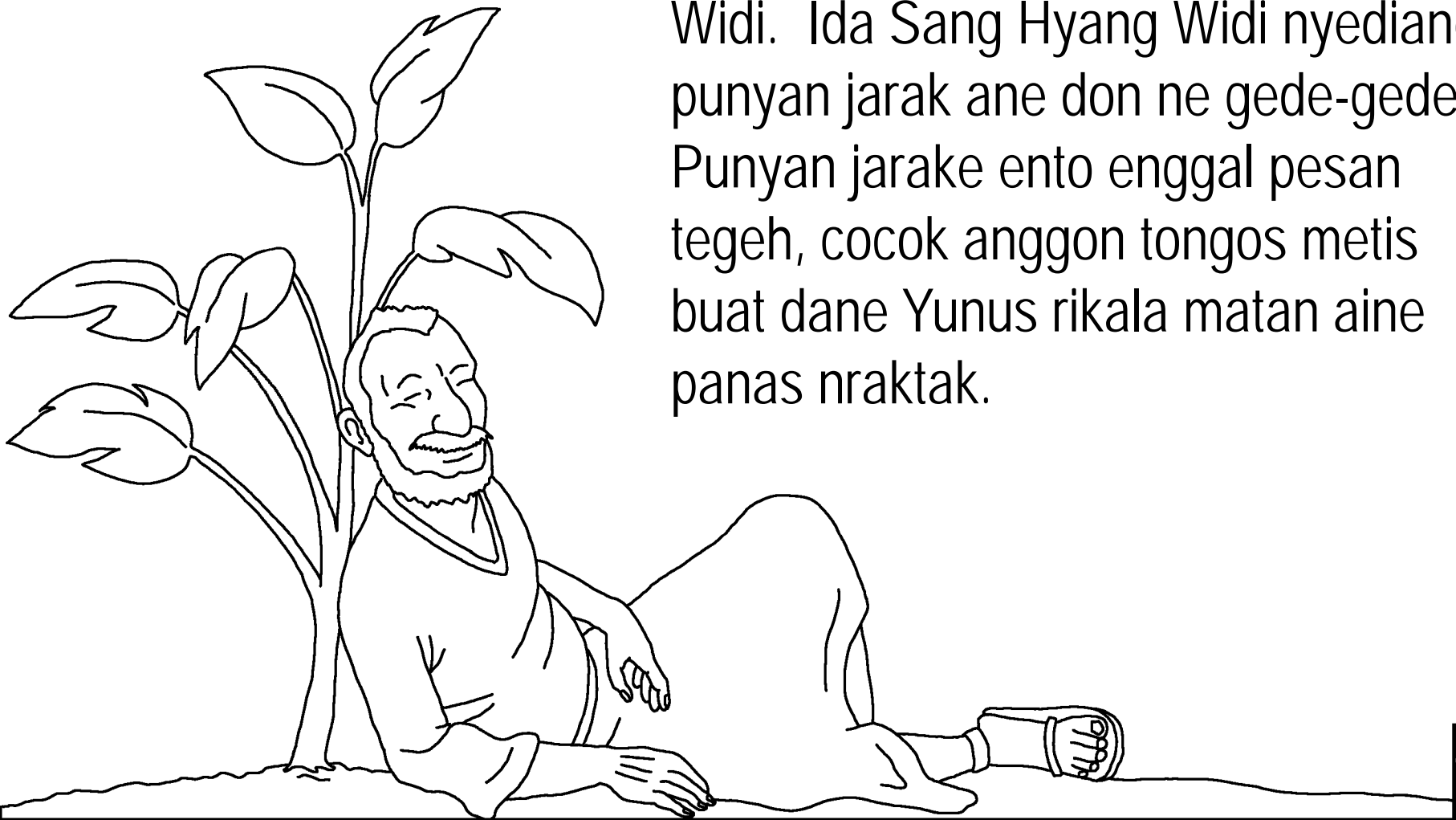

Buin mani semengane, Ida Sang Hyang Widi ngutus uled apanga ia ngamah don jarake nganti mati. Lantas Ida Sang Hyang Widi ngadakang angin baret lan cuaca ane panes pesan, nganti Yunus ngaden awak ne lakar mati. Unduke ene ngranayang dane Yunus nyangetang gedeg ne.



Lantas Ida Sang Hyang Widi ngandika ring dane Yunus, "Apeke cening ngelah hak memedih? Cening sayang teken punyan jarak ane sing pula lan idupang cening. Punyan jarake ento idup tuah apeteng terus buin manine ia mati. Ngudiang dadi

Ulun sing dadi nyinahan kawisesan Ulune teken bangsa Niniwene, kota ane gede lan ane pendudukne liu?"

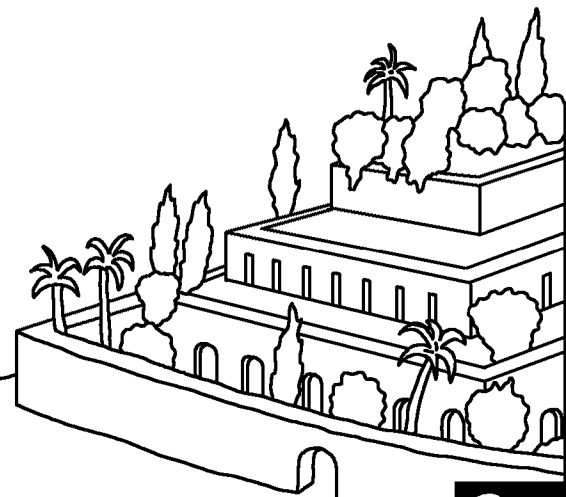
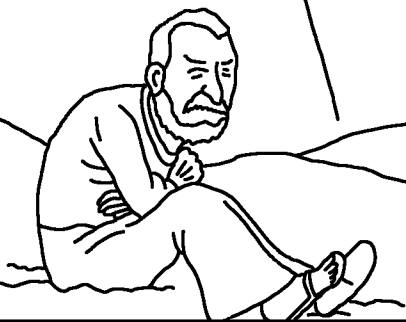

Dane Yunus lan Be Ane Gede

Wenten katuturan carita saking pengandika Ida sang Hyang  
widi mewasta Alkitab,

dados sobyahang ring

Yunus

"Pemargin saking pengandika Ida Ngicenin Karahayuan."

Mazmur 119:130





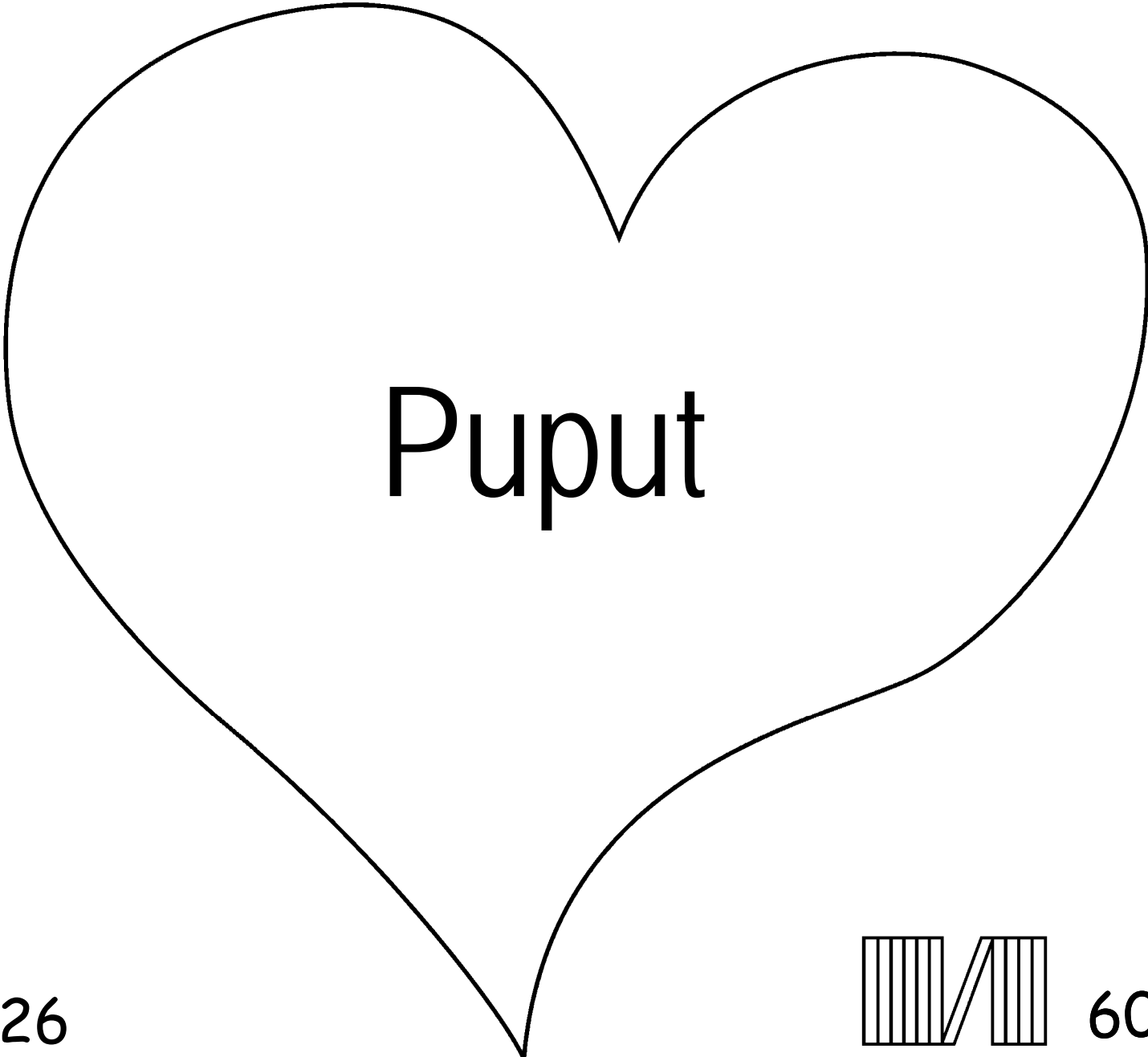

Puput

| 26

||||| 60



Carita ring Alkitab puniki nyaritayang indik Ida Hyang Widhi mahotama sane ngripta iragane tur sane mapikayun iraga nguningin Ida.

Ida Hyang Whidi uning iraga sampun melaksana sane iwang, sane kaucap antuk papa. Papongoran antuk jadmā sane melaksana papa inggih punika lepas utawi padem, sakewanten Ida Hyang Whidi dahat sutresna. Ida raris ngutus okan Idane sane meraga tunggal, sane mapesengan Ida Hyang Yesus Kristus, mangda Ida lepas ring taru Salib tur kapongor sangkaning kaiwangan iragane. Ida Hyang Yesus urip malih tur mantuk ka Suarga loka! Yening ragane pracaya indik Ida Hyang Yesus tur mapinunas mangda Ida ngicenin pangampura antuk keiwangan-kaiwangan iragane, Ida jagi nglaksanayang! Ida jagi rauh tur meneng ring sejeroning pareragan ragane sane mangkin, tur ragane jagi nyeneng sareng Ida ngantos riwekasan.

Yening ragane pracaya indik kepatutan punika, nikaang puniki ring Ida Hyang Widhi: Ida Hyang Yesus, tityang pracaya pareragan Idane sawiakti Ida Hyang Parama Kawi, nanging Ida nyeneng dados manusa sane lepas santukan nebasin kaiwangan iragane, tur sane mangkin Ida pacang urip malih. Dumogi Ida rauh ring kauripan iragane lan ngicen pangampura antuk keiwangan iraga makesami, sane ngawinang irage madue keuripan sane anyar tur buin pidan irage pacang meraga siki sareng Ida. Wantu tityang satinut sareng titah Idane tur idup daos pianak Ida, Amin.

Ngiring ngewacén Alkitab tur mapitutur sareng Ida Hyang Widhi ngerahina! Yohanes 3:16

