

Bibel tu angka dakdanak
patomutomuhon

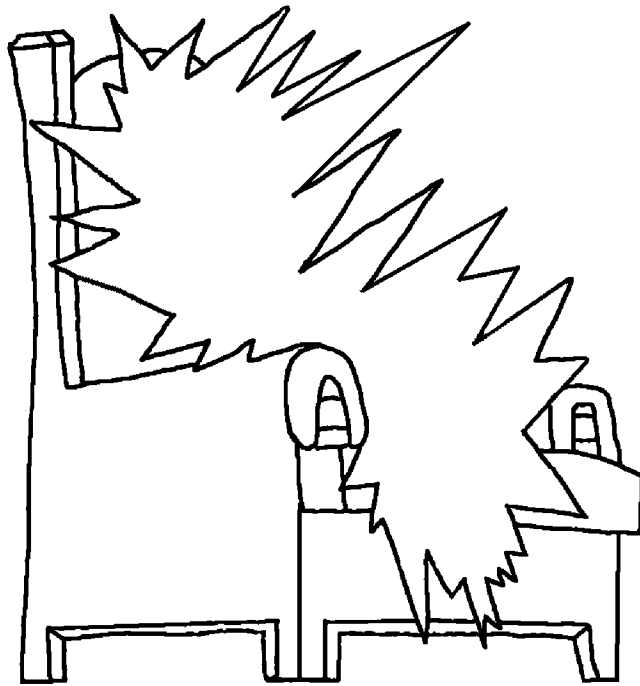

Banua Ginjang
(Surgo), Huta
Nauli ni
Debata



Sinurathon ni: Edward Hughes
Illustrasi sian: Lazarus
Alastair Paterson
Sinadur ni: Sarah S.
Nihatabatakxon ni: Marihot Siahaan
Hinaruarhon ni: Bible for Children
www.M1914.org

BFC
PO Box 3
Winnipeg, MB R3C 2G1
Canada

©2021 Bible for Children, Inc.

Ijin: Manang ise pe, boi do mamotokopi manang pagandahon cerita on,
asal ma unang digadis.



Di tingki di tano on dope Jesus nunga
dipaboa tu angka siseanNa taringot
tu Banua Ginjang. Didok Ibana ma
i "Bagas ni AmangKu", jala didok
adong godang inganan disi.

Sada inganan na balga,
huta na uli. Umbalga
jala ummuli do Banua
Ginjang sian huta
di tano on.

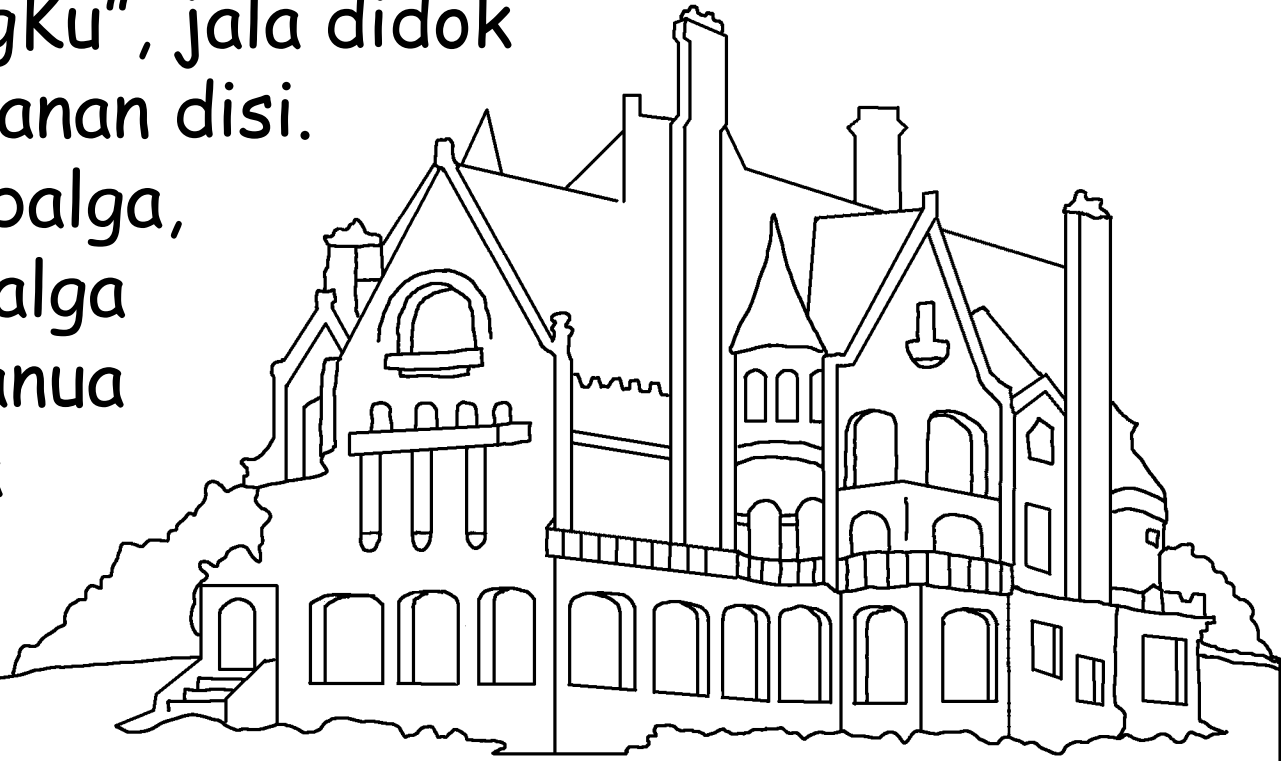

Didok Jesus ma, "Na laho ma Ahu paradehon inganan di hamu. Jala molo laho ahu jala huparade inganan di hamu, ro do Ahu muse jala jaloonku ma hamu tu diringku."

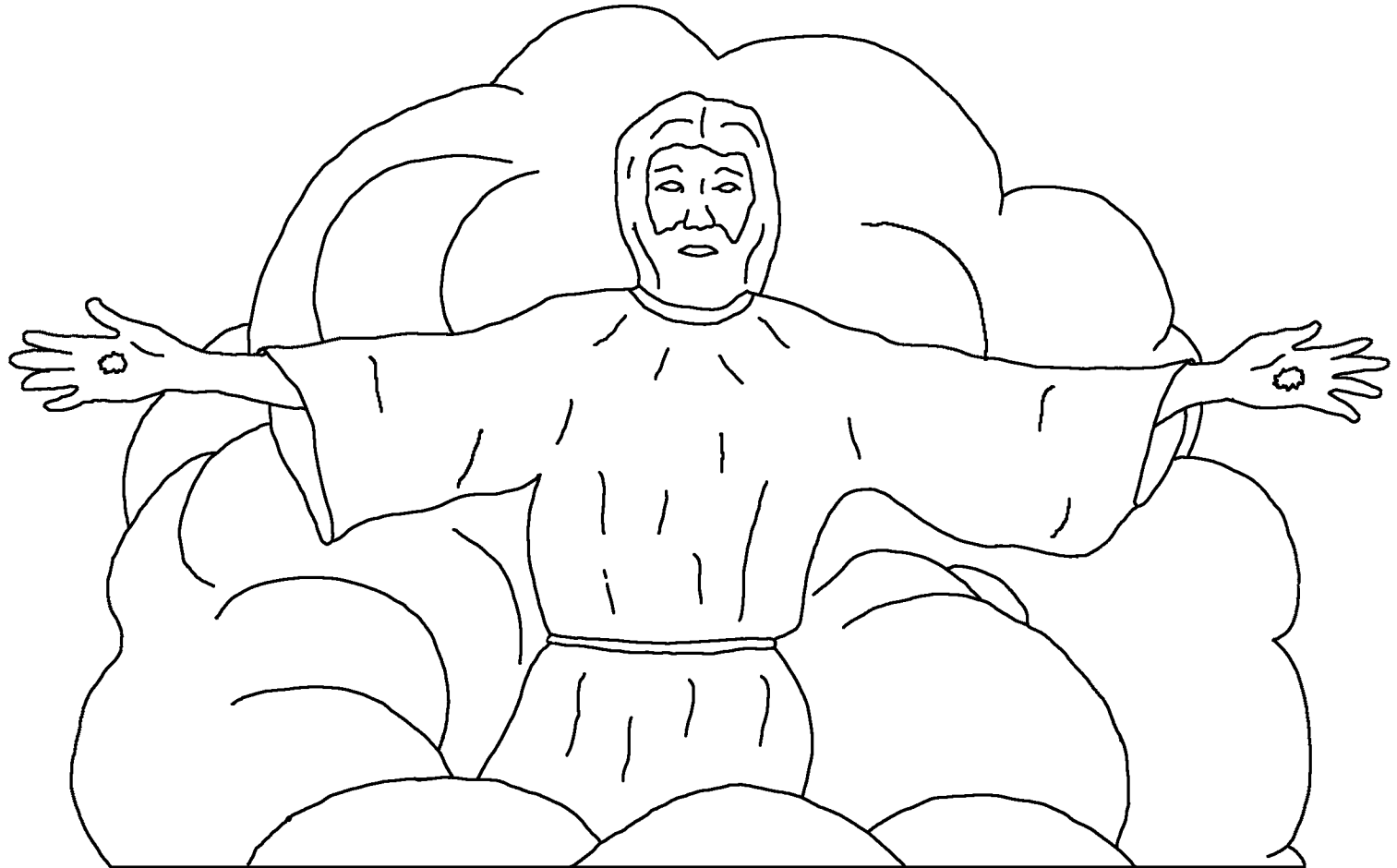

Laho ma Jesus tu Banua Ginjang, dung hehe Ibana sian hamatean. Di tingki pungu angka siseanNa i, tarhinsat ma Jesus, jala diboan ombun ma Ibana onding sian mata nasida.

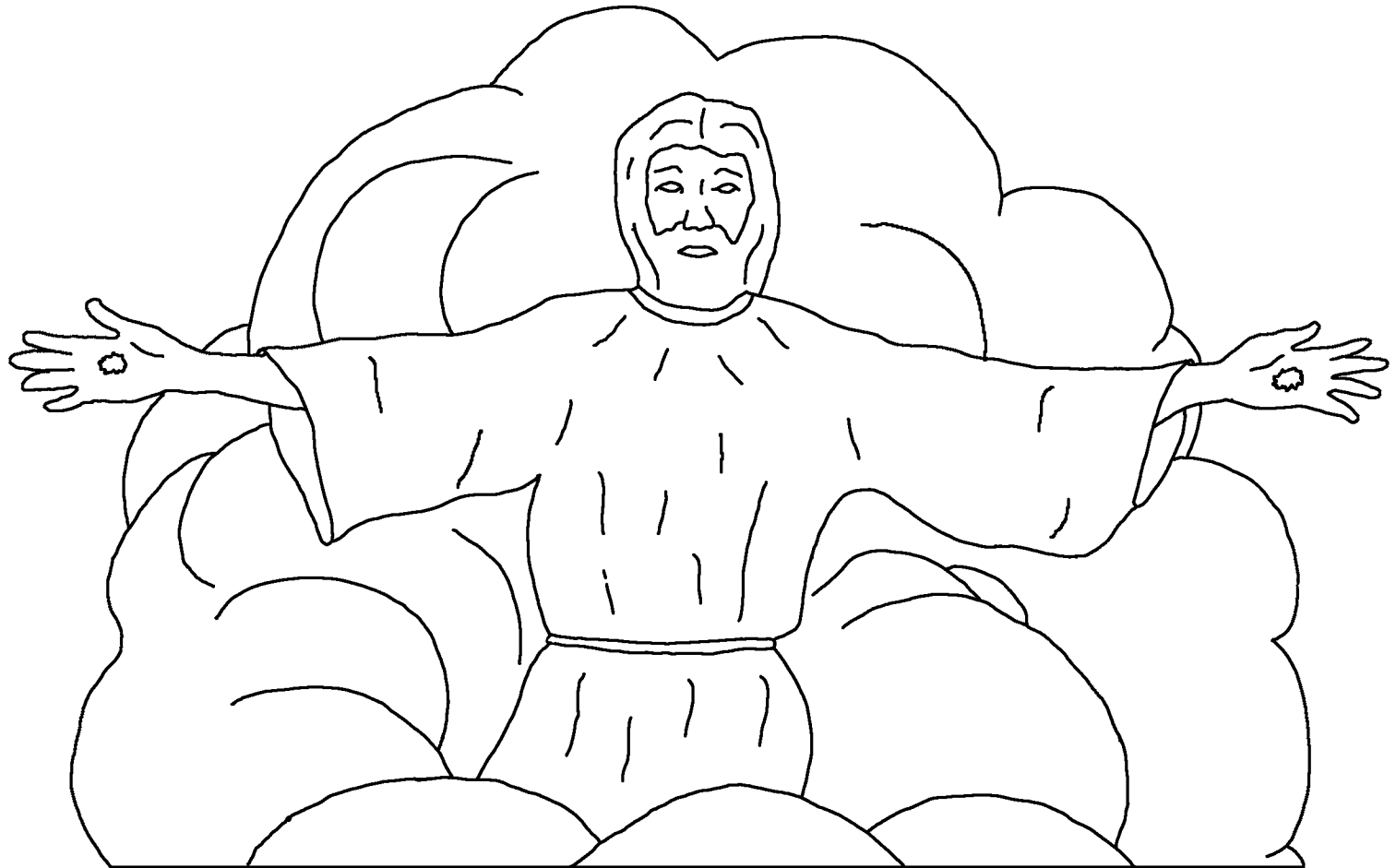

Dung i, nunga diingot halak Kristen janji ni
Jesus, na ro do Ibana muse mangalap nasida. Didok
Jesus, tompu do Ibana ro muse, di tingki so
panagaman. Alai boha do taringot
tu halak Kristen naung monding
andorang so ro dope Ibana?
Bibel mandok, laos rap
dohot Jesus nama
nasida laho. Ndang
ro di bagasan

daging lapatanna
ro raphon
Tuhan i.



Pangungkapon, i ma buku na parpudi Bibel,
pabotohon tu hita hinauli ni Banua Gintang. Apala
na andul ummuli i, Banua Gintang do huta ni Debata.
Adong do nian Debata di sude inganan, alai anggo

habangsaNa I ma di
Banua Gintang.

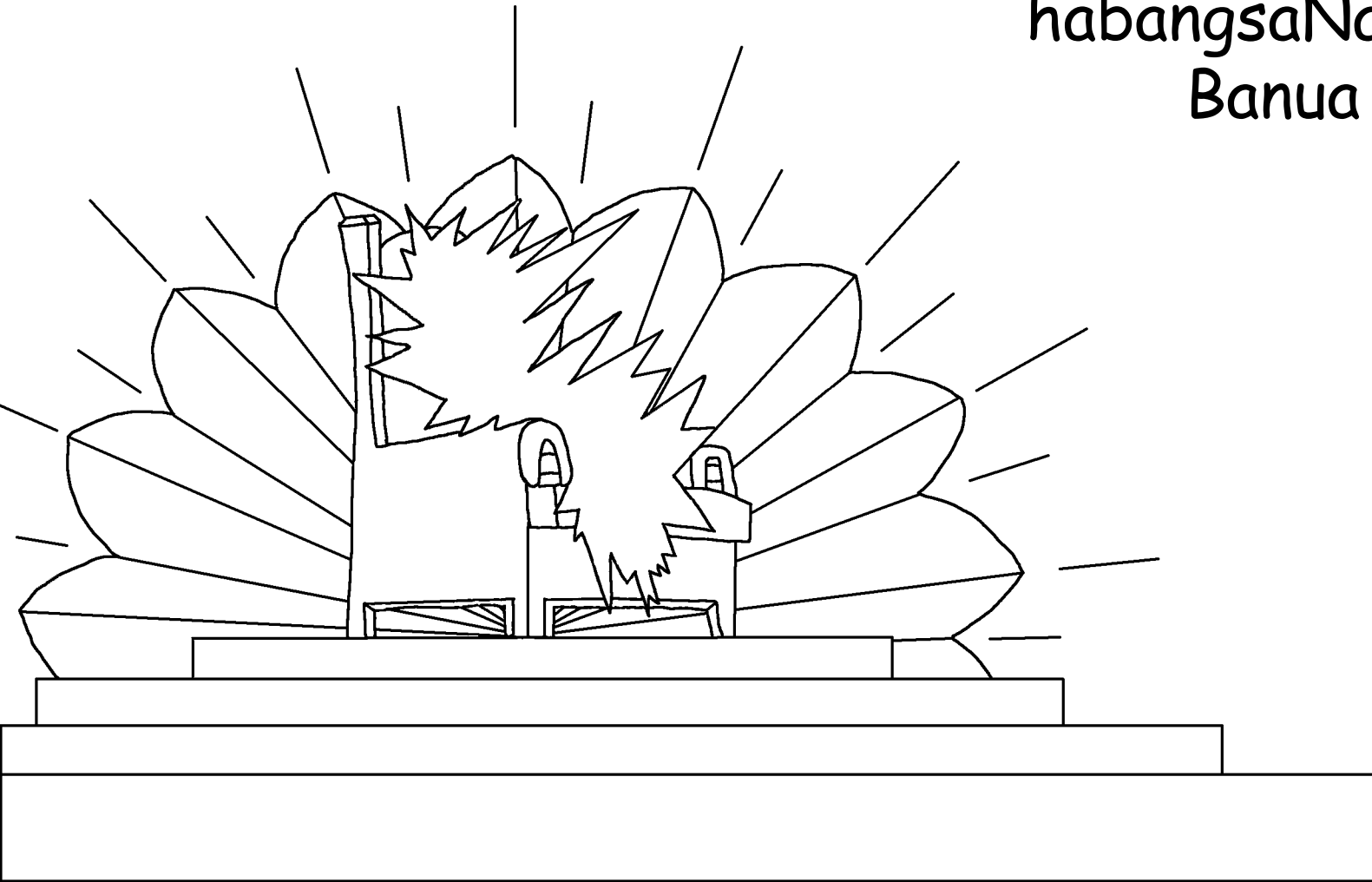

Surusuruan dohot parangan parbanua
ginjang mamuji Debata di Banua
Ginjang. Songon i ma dibahen
angka bangso ni Debata angka
naung mate jala naung laho tu
Banua Ginjang. Nasida
mangendehon
angka ende
pujipujian
tu Debata.

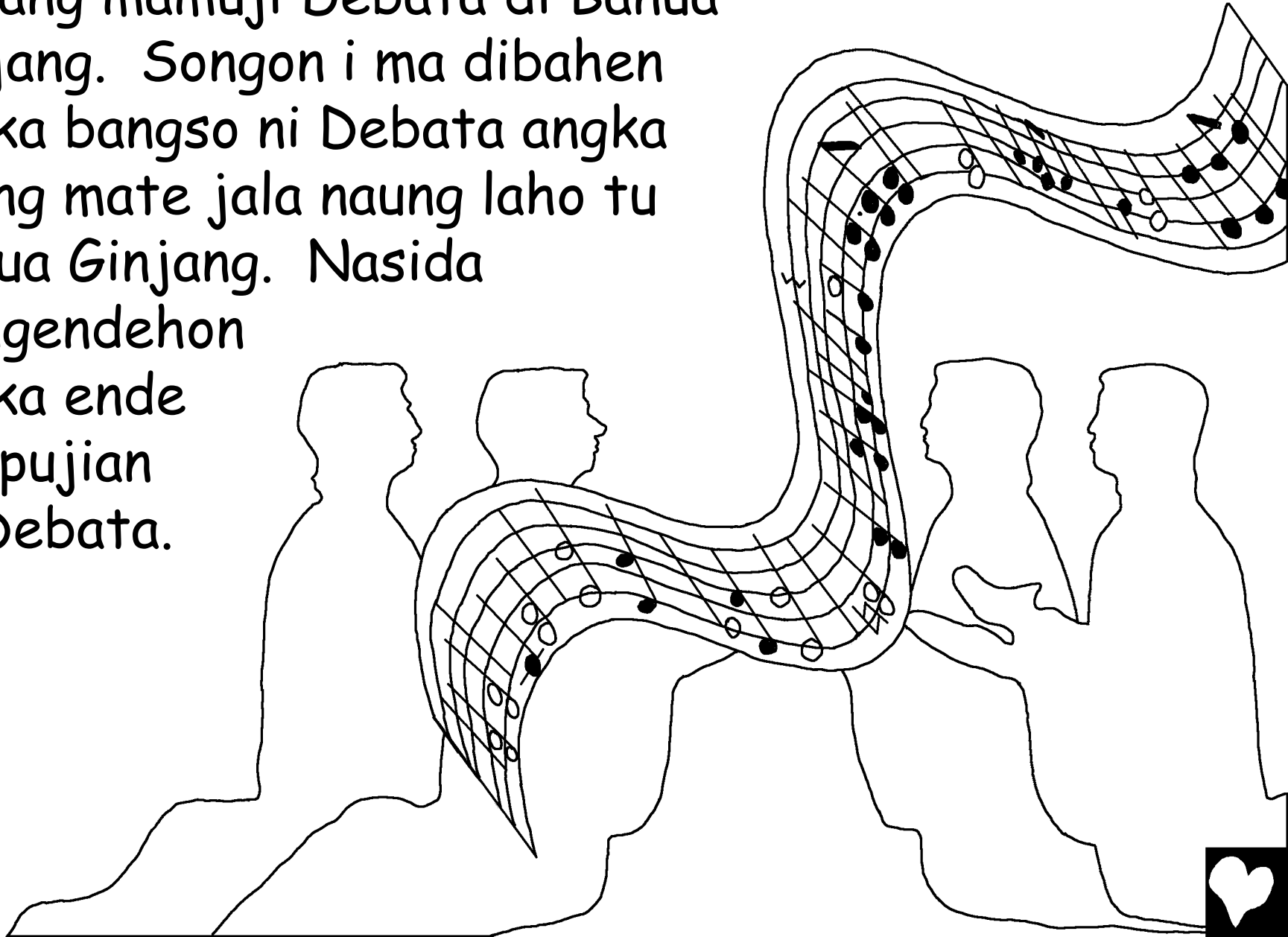

On ma hata ni sada ende na niendehon nasida: AI
NAUNG TARBUNU DO HO JALA MARHITE
MUDARMU DITOBUS HO DO
TU DEBATA JOLMA SIAN
SALUHUT MARGA, HATA,
HOUM DOHOT BANGSO.
JALA DIJADIHON HO DO
NASIDA GABE
HARAJAON
HAMULIAON
NI DEBATA.
(Wahyu
5:9-10)

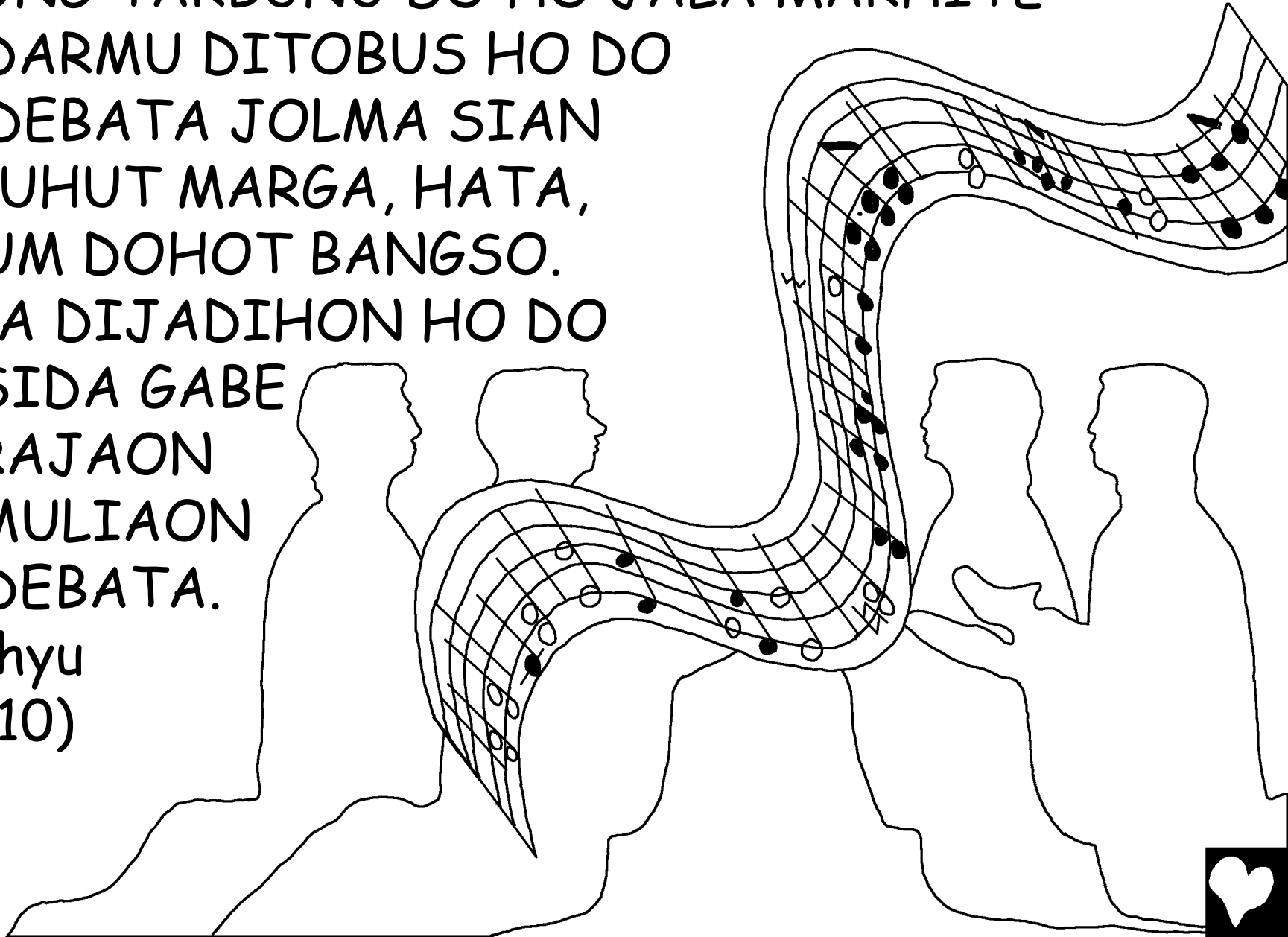

Apala halaman na parpudi sian Bibel manggombahon
Banua Gijang songon "Jerusalem Na Imbaru". Tung
mansai balga, jala marparik na timbo do i di duru.
Parikna i sian batu na uli, na marhillong. Angka intan
dohot batu na arga mangalapis dasor ni parik i,

rupana marhillong

jala
uli.
Ganup
harbangan
dibahen
sian mutiara
tunggal
na balga.

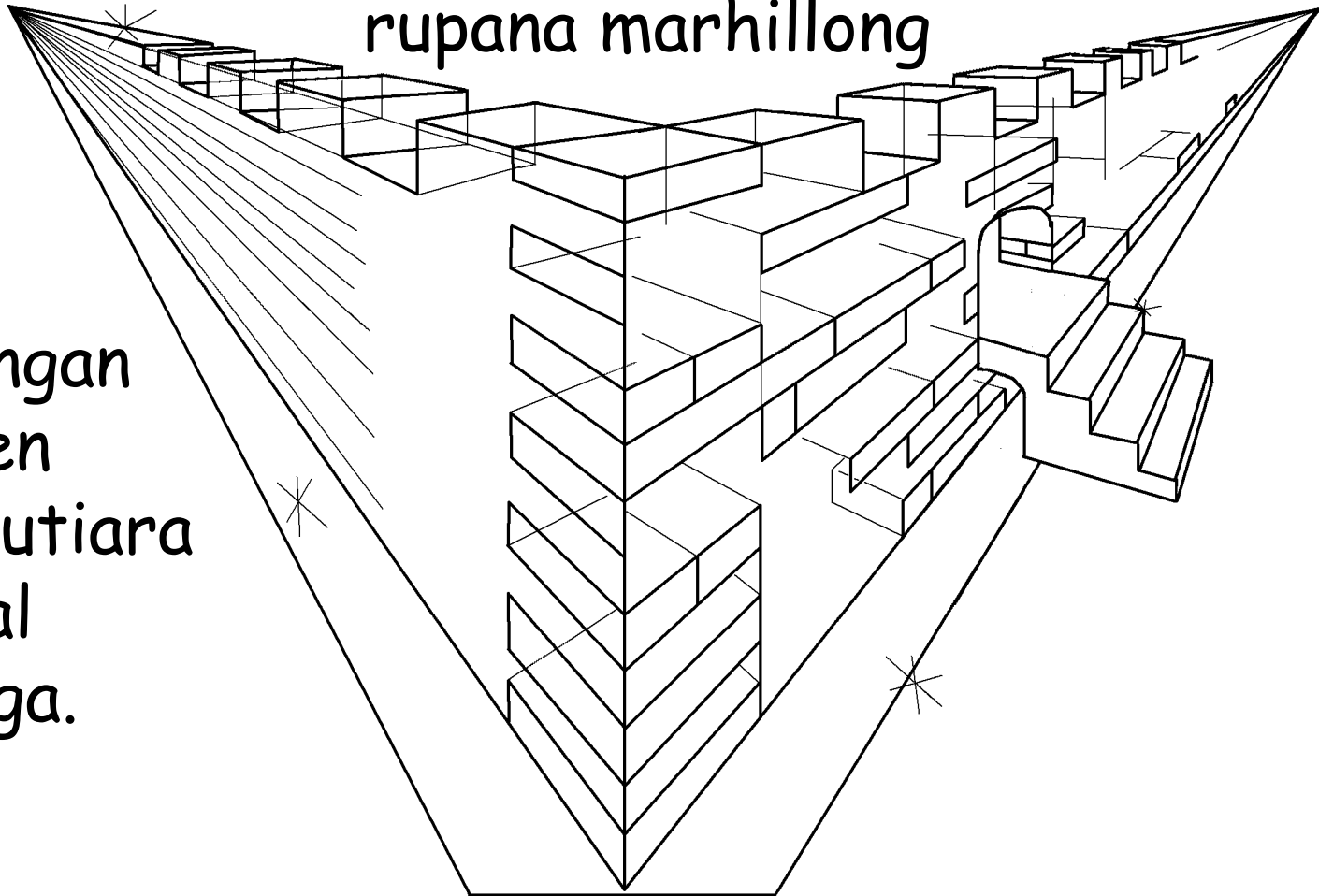

Angka harbangan na sian mutiara i ndang hea
martutup. Beta hita masuk tu bagasan jala taida
humaliang...O uli ni! Ummuli muse dope surgo i di
bagasan. Dibahen do huta i sian mas tulen, songon

galas na tio. Gari
dalan pe dibahen
sian mas.

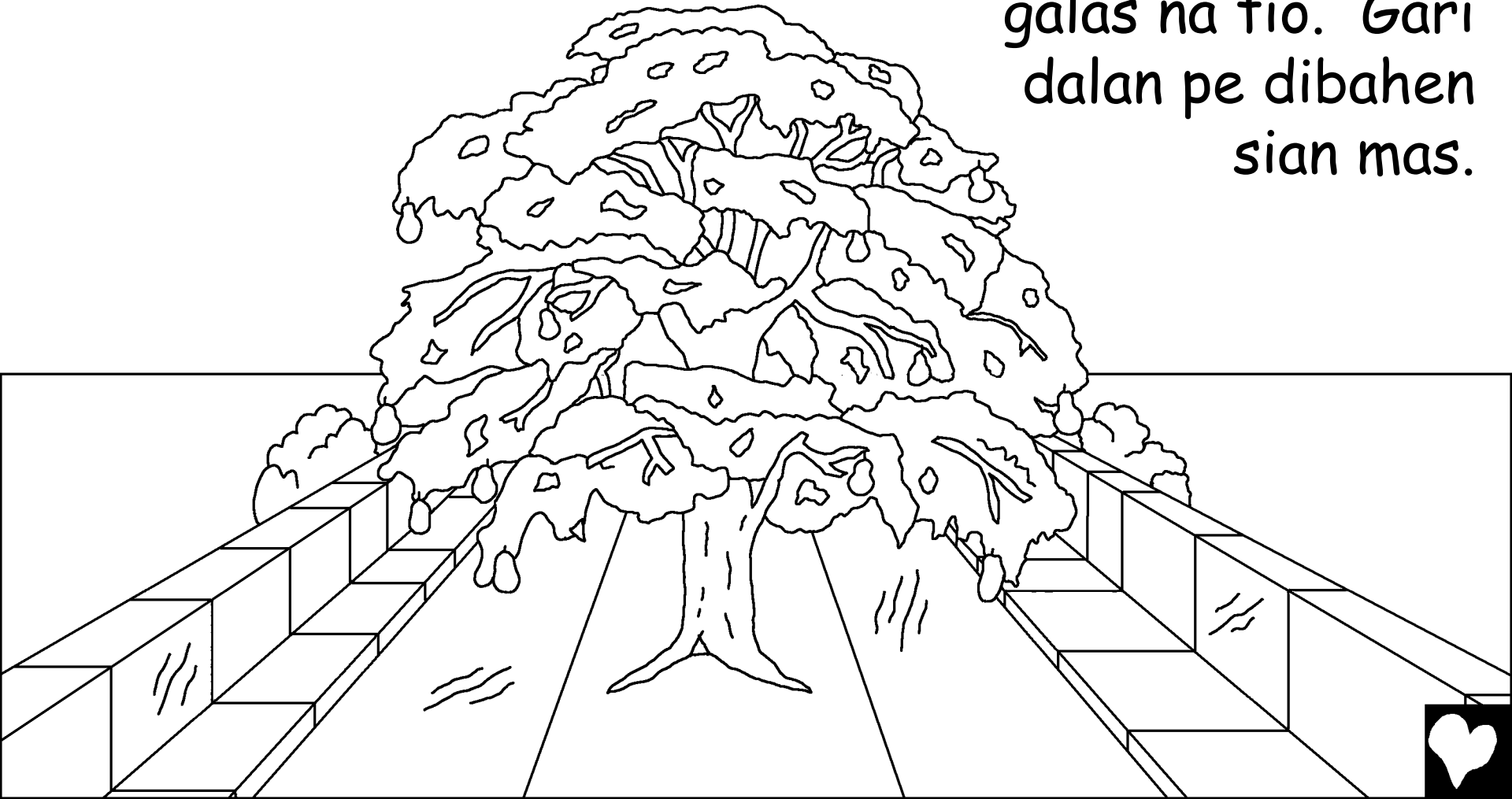

Sada sunge na uli jala na tio sian aek hangoluan mabaor sian habangsa ni Debata. Di bariba ni aek i adong do hau hangoluan, i ma na adong di mulana i di Porlak Eden. Mansai andul do hau i. Marparbuehon sampulu dua ragam na marasing, songon ragam ni ganup bulan. Jala bulung ni hau hangoluan i gabe pandaoni ni ganup bangso.

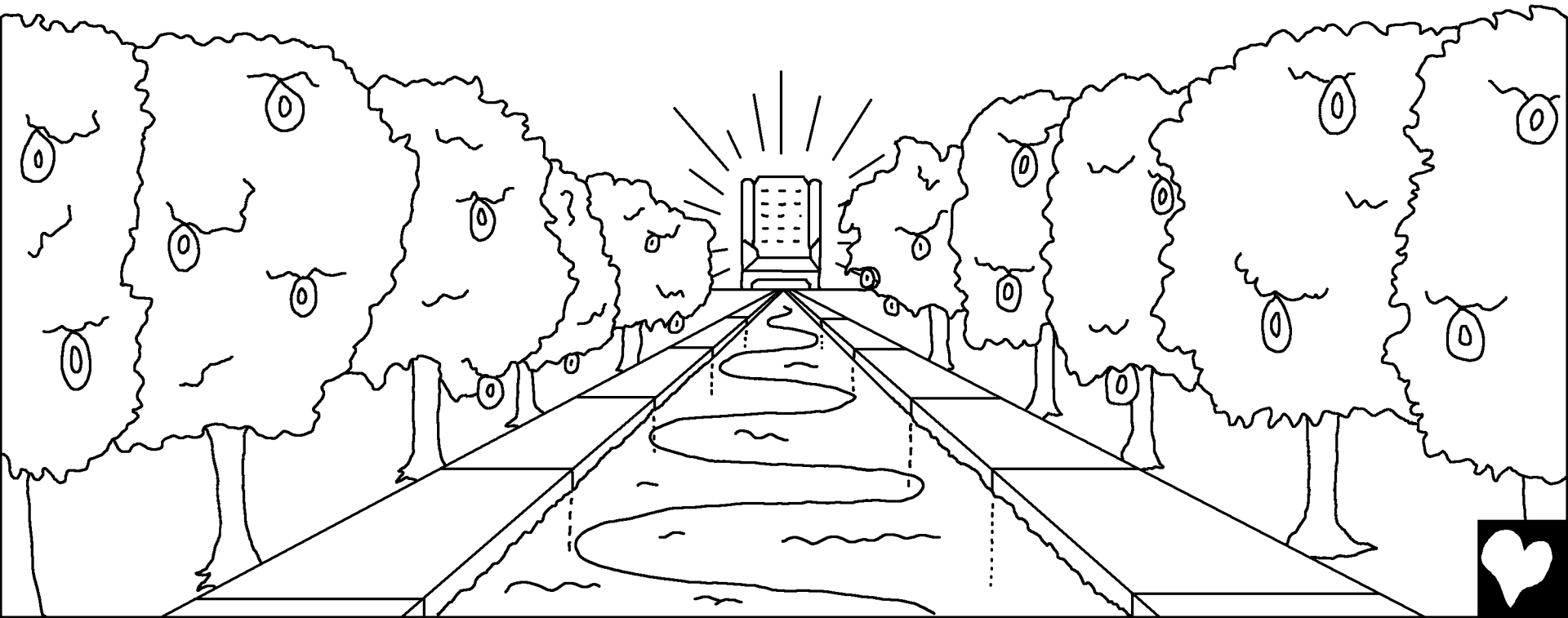

Ndang porlu be di Banua Ginjang mata ni ari manang bulan laho manondangi. Hamuliaon ni Debata do manggohisa dohot sinondang na tung mansai tiur. Ndang adong be borngin disi.

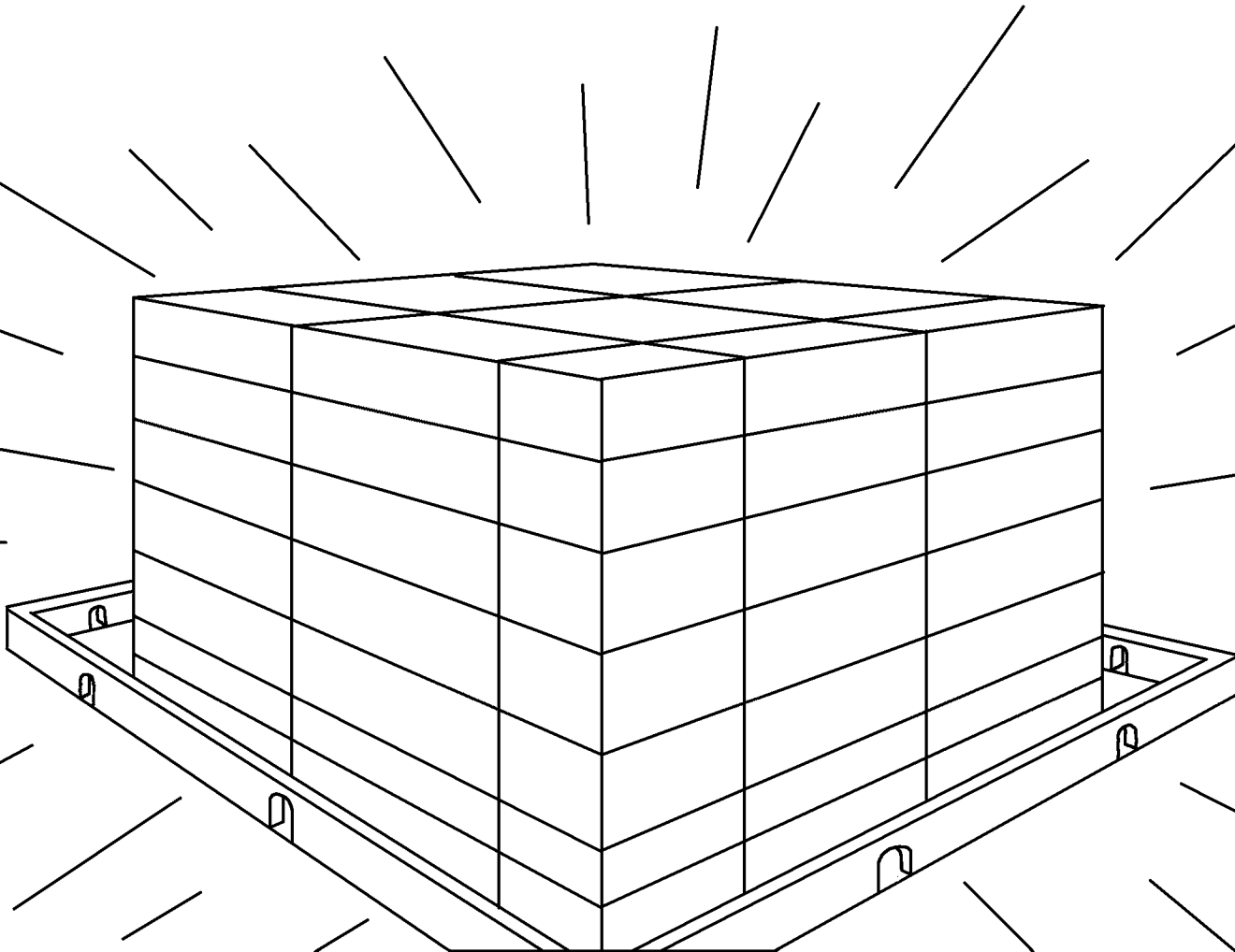

Gari angka binatang na di Banua Ginjang i nunga
asing. Sasudena jinak jala maraleale. Sorigala
dohot birubiru rap manggagat. Gari singa
manganhon durame songon lembu. Ninna Tuhan i,
"Ndang masiharatan jala ndang masibunuan be
nasida di angka dolok habadiaonKu."

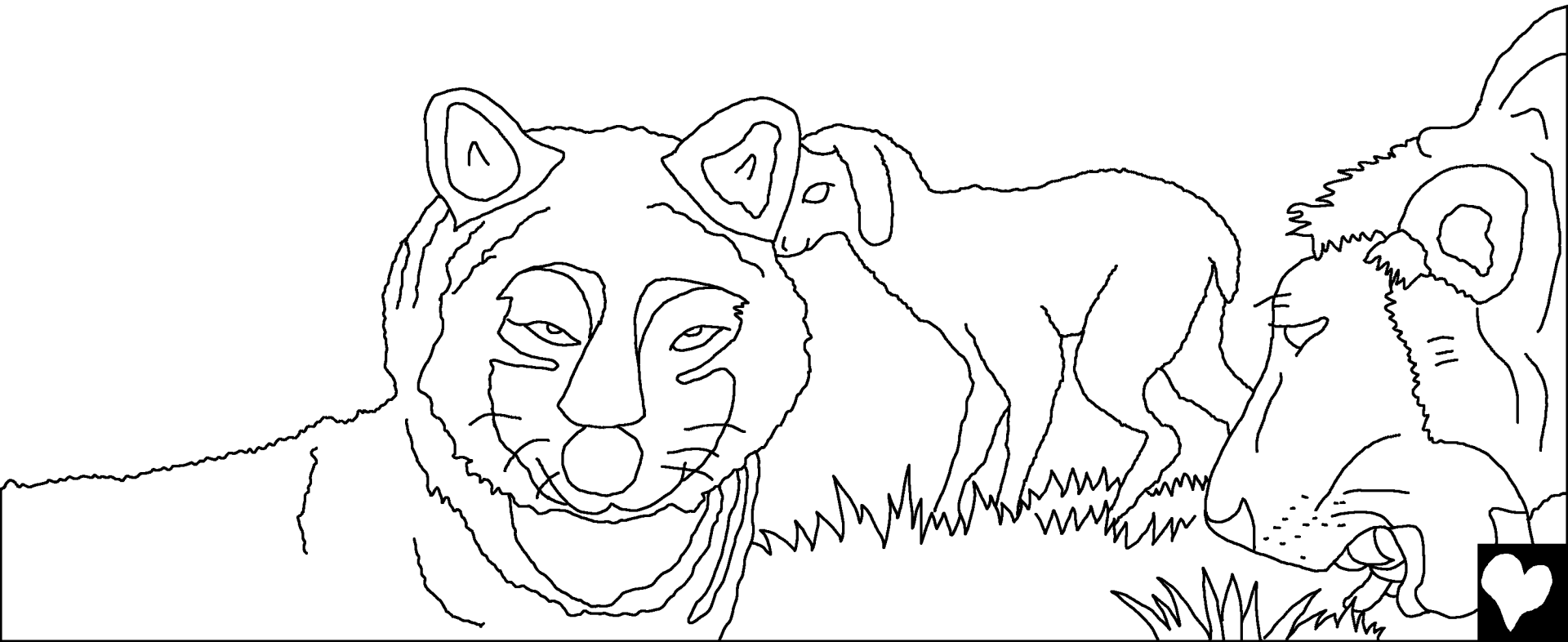

Dung taida humaliang, taida ma adong
do na mago sian Banua Ginjang.

Ndang adong be
hata muruk
begeon.

Ndang
adong na
marbada
manang
na holan
manarihon
dirina.

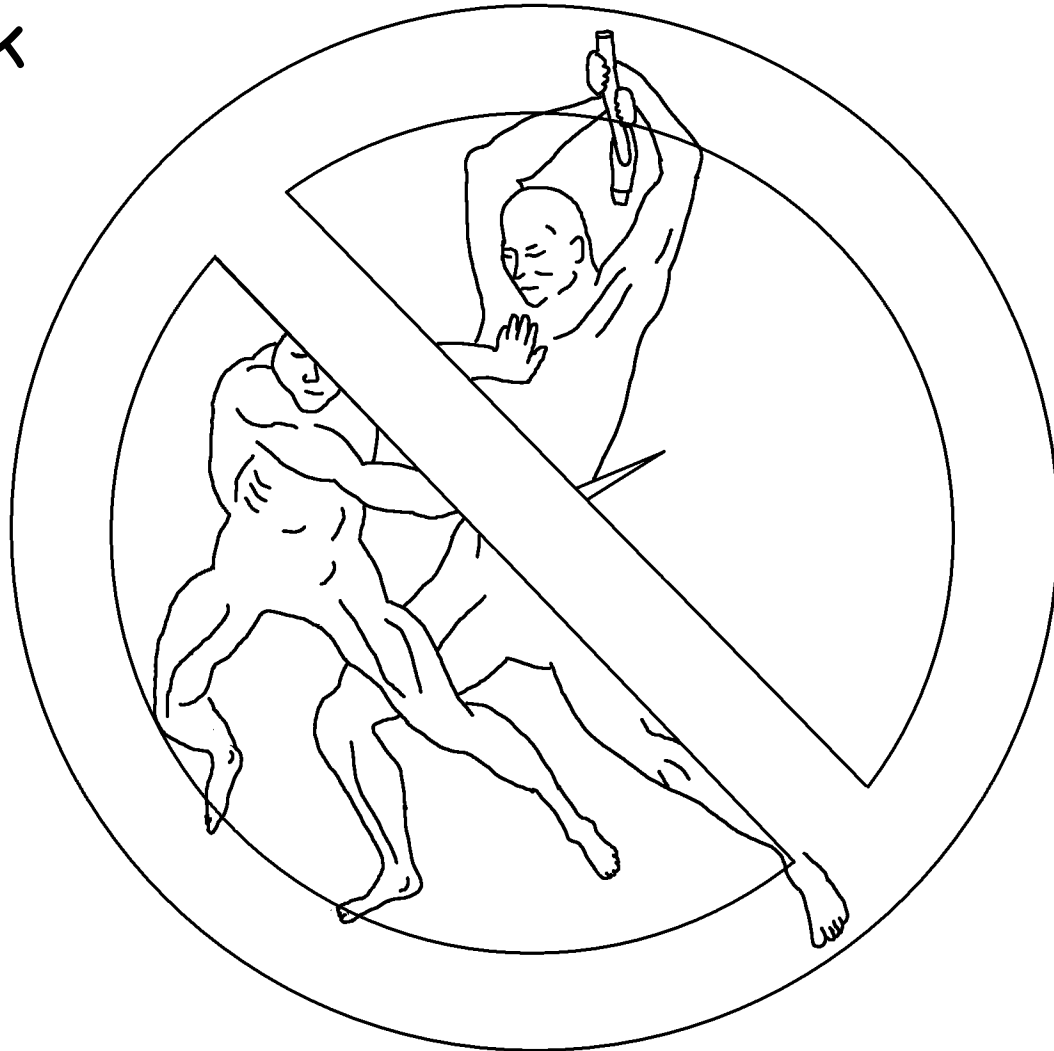

Ndang adong be kunci di angka pintu, ala ndang adong panangko di Banua Ginjang. Ndang adong pargabus, pamunu, partondung, manang angka parjahat na asing. Ndang adong be dosa di Surgo i.

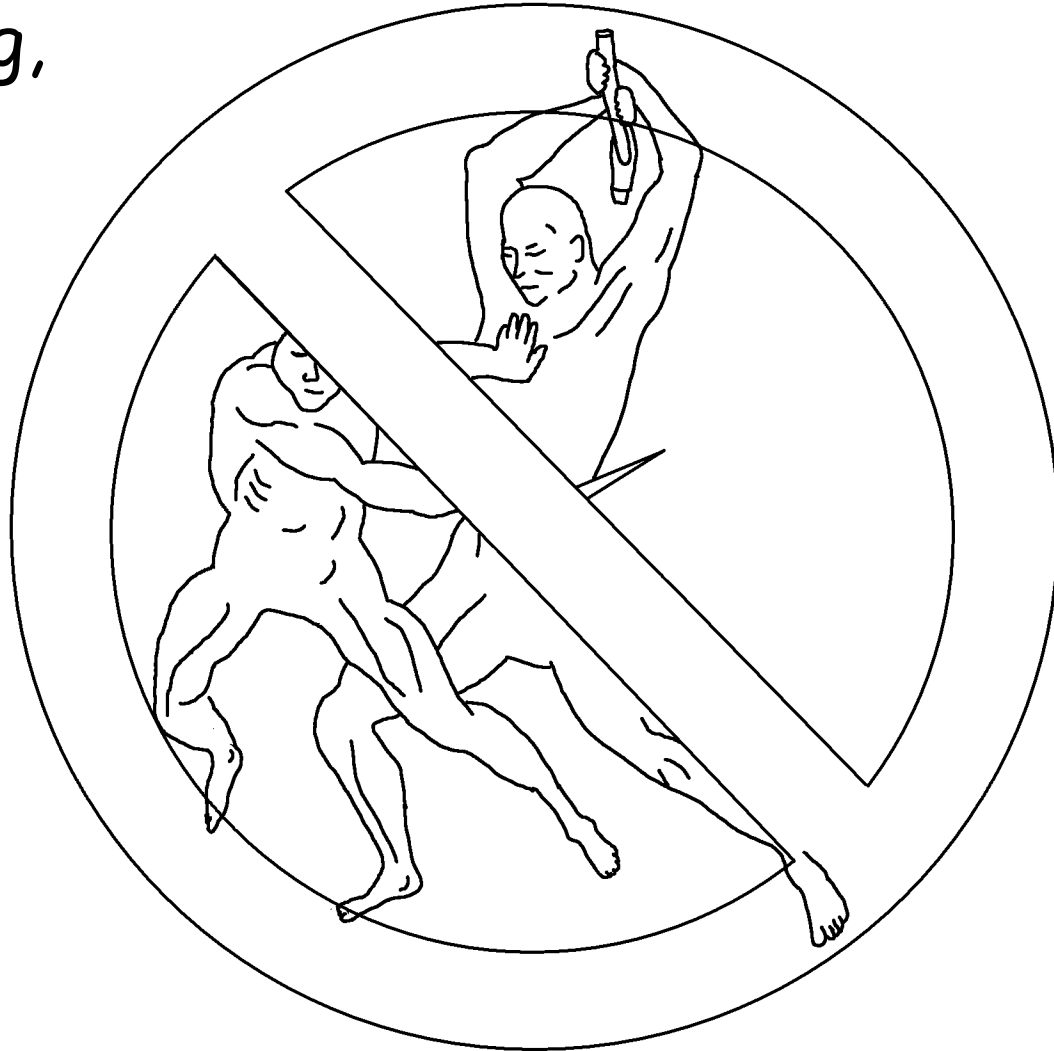

Di Banua Ginjang, rap
dohot Debata ndang
adong be iluilu. Sipata,
joujou do bangso ni
Debata ala borat ni
sitaonon di ngolu on. Di
Banua Ginjang diapusi
Debata do nasa ilu.



Ndang adong be nang hamatean di Surgo.
Manongtong ma bangso ni Debata rap dohot
Tuhan i. Ndang adong be sitaonon, ndang adong
partangison, ndang na hansitan.

Ndang parsahiton,
ndang adong
parsirangan,
ndang adong
pananomom.

Sasude na di
Surgo marlas
roha na
manongtong
rap dohot
Debata.



Apala na dumenggan sian sude, ia adong pe Surgo i ima asa boi masuk tusi angka baa dohot boruboru na porsea di Jesus Kristus, Sipalua, jala mangoloi Ibana gabe Tuhan nasida. Di Banua Ginjang adong do buku na ginoaran Buku Hangoluan ni Birubiru. Gok do disi goar ni jolma. Diboto ho do angka goar ni ise tarsurat disi? Sude jolma na porsea di Jesus.

Adong do goarMu disi?

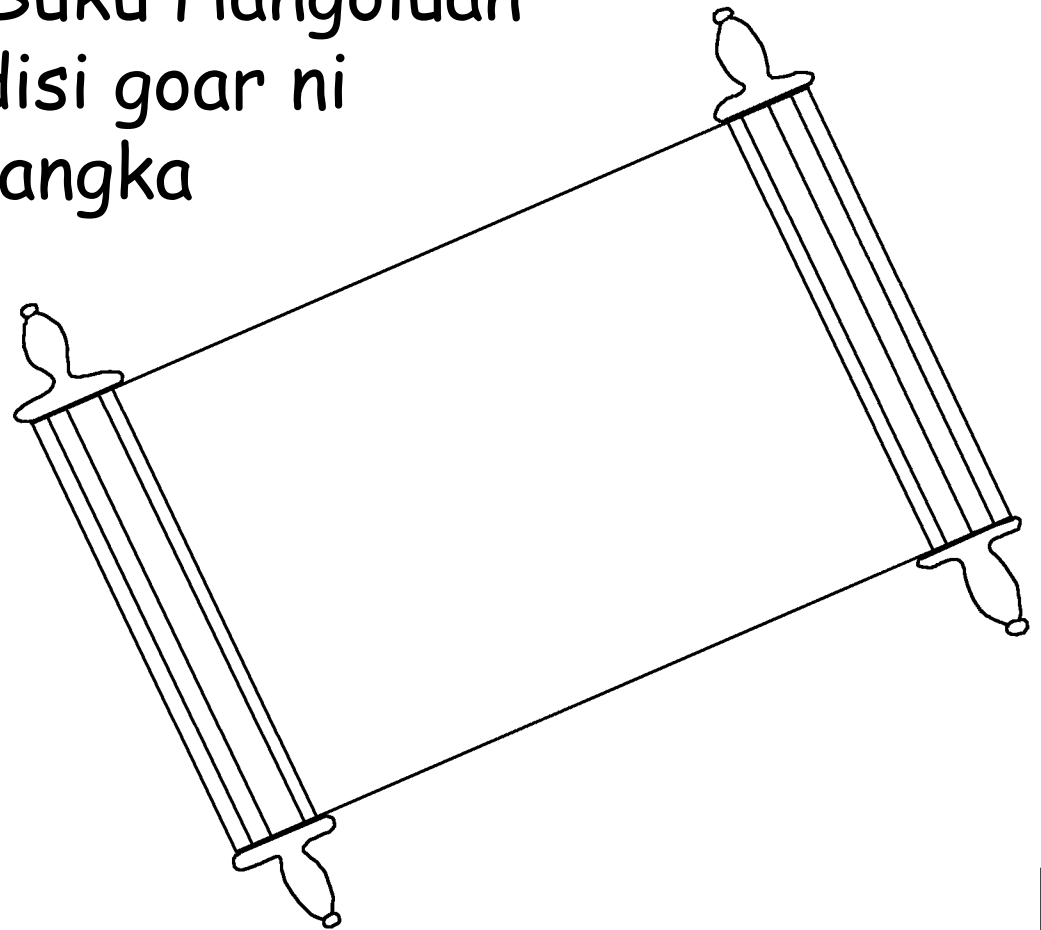

Hata na parpudi di Bibel taringot tu Surgo, ima
gokhon na mansai uli. "Jadi didok Tondi dohot
oroan i ma: Ro ma Ho! Laos dohonon ni na
umbegesa: Ro ma ho! Sai ro ma na mauas; dijalo ma
giot roha i ma aek hangoluan i, dalam basabasa!"



Banua Ginjang (Surgo), Huta Nauli ni Debata

Dapot do sada barita sian hata ni Debata,

ima Bibel,

Johannes 14, 2 Korint 5,
Pangungkapon 4, 21, 22

"Pangungkapon di angka hataMi do patiur
parnidaan." Psalmen 119:130



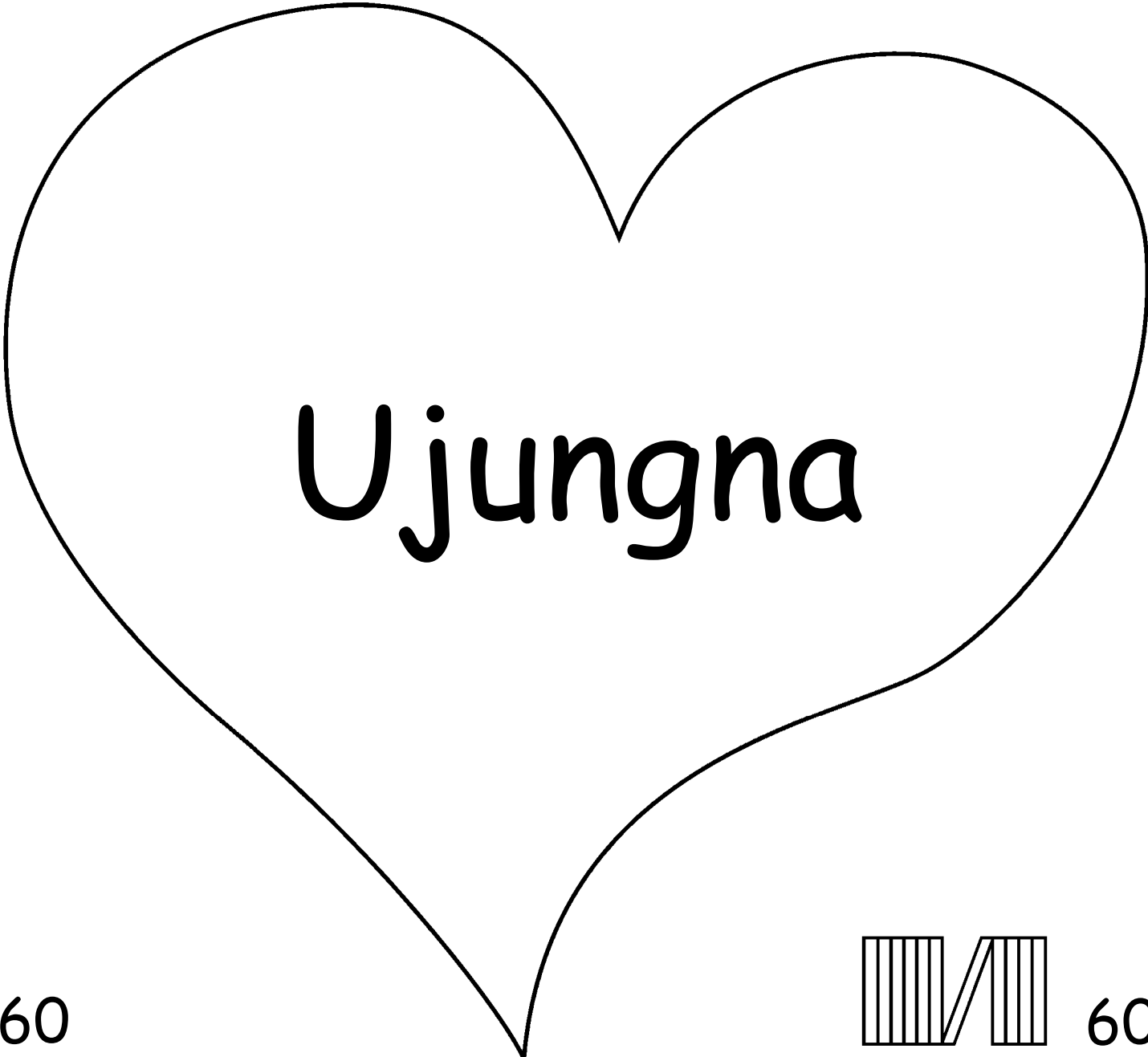

Ujungna

60

60



Dipabotohon Carita Bibel on tu hita taringot tu Debata na sun hinagogo, na manompa jala na manghasiholi ho asa mananda Ibana.

Diboto Debata do naung taulahon angka na roa, i ma dosa. Hamatean do uhum ni dosa, alai mansai holong do roha ni Debata di Ho, i do umbahen na ditongos AnakNa na sasada i, Jesus. Nunga mate tarsilang jala hona uhum Ibana ala ni dosam. Dung i mulak mangolu ma Ibana, jala mulak muse tu Banua Gijnjang! Molo porsea ho di Jesus jala dipangido roham asa disesa dosam, sai na patupaonNa do i! Ro do Ibana jala mian di bagasan ho saonari, dung i mangolu ma ho rap dohot Ibana ro di salelengna.

Molo porsea do ho di hasintongan on, dok ma songon on tu Debata:
O Jesus, porsea do ahu na Debata do Ho, jala naung gabe jolma.
Naung mate do Ho ala ni dosanku, alai nuaeng mulak mangolu do Ho.
Ro ma Ho tu ngolungku jala sesa ma dosanku, asa dapot ahu ngolu na imbaru, jala molo ro tingkina, gabe rap ahu dohot Ho ro di salelengna.
Urupi ma ahu mangoloi Ho jala mangolu di Ho songon anakhonMu.
Amen.

Jaha ma Bibel i jala manghatai ma ho dohot Debata ganup ari!
Johannes 3:16

