

www.BibleForChildren.org



Yoni 14



To Yesu pana' aलोबो' a ka lu epi' ehina: Komopatinigu
koli mehilo. Lenali Hu' mamofitoga keheli ule' ale hite
to nani' nitoga ana hite keheli ule' ale hilo. Ifo muyalo
Afo' nifihi hepa' i ni' inalo nohi babu luto ni' inagi nani
kohe toto tito hepatini li kuguma hilube.

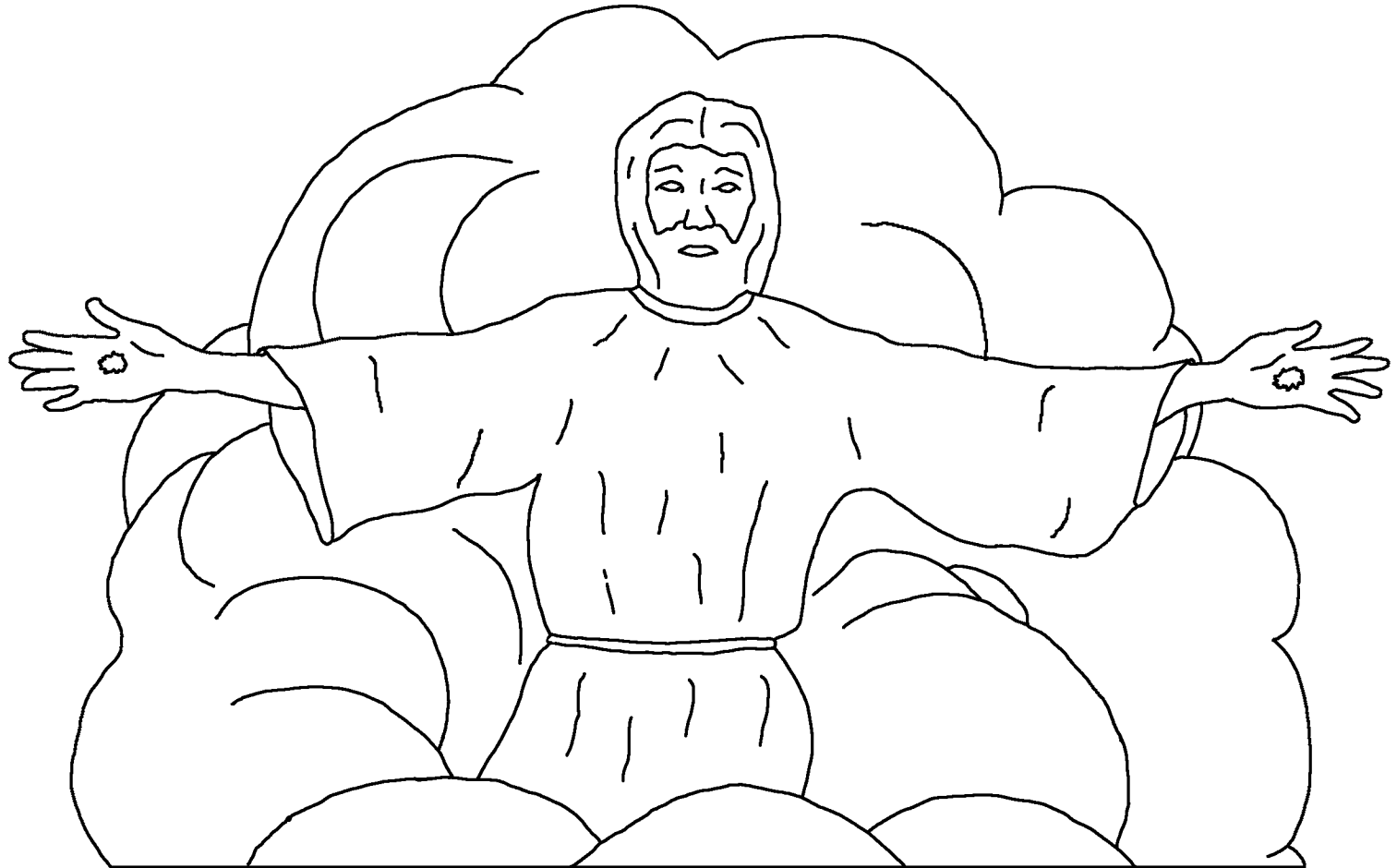

Yanuga li kuguma hu su holoto'ni i behe hu limito
lenali kumu lenele'malube luto'ni lenali hiti nani
nohunalo minalune. Ya'ma huto hilinamo meni'itita
lu hokolo hu leputita'mu yabe.

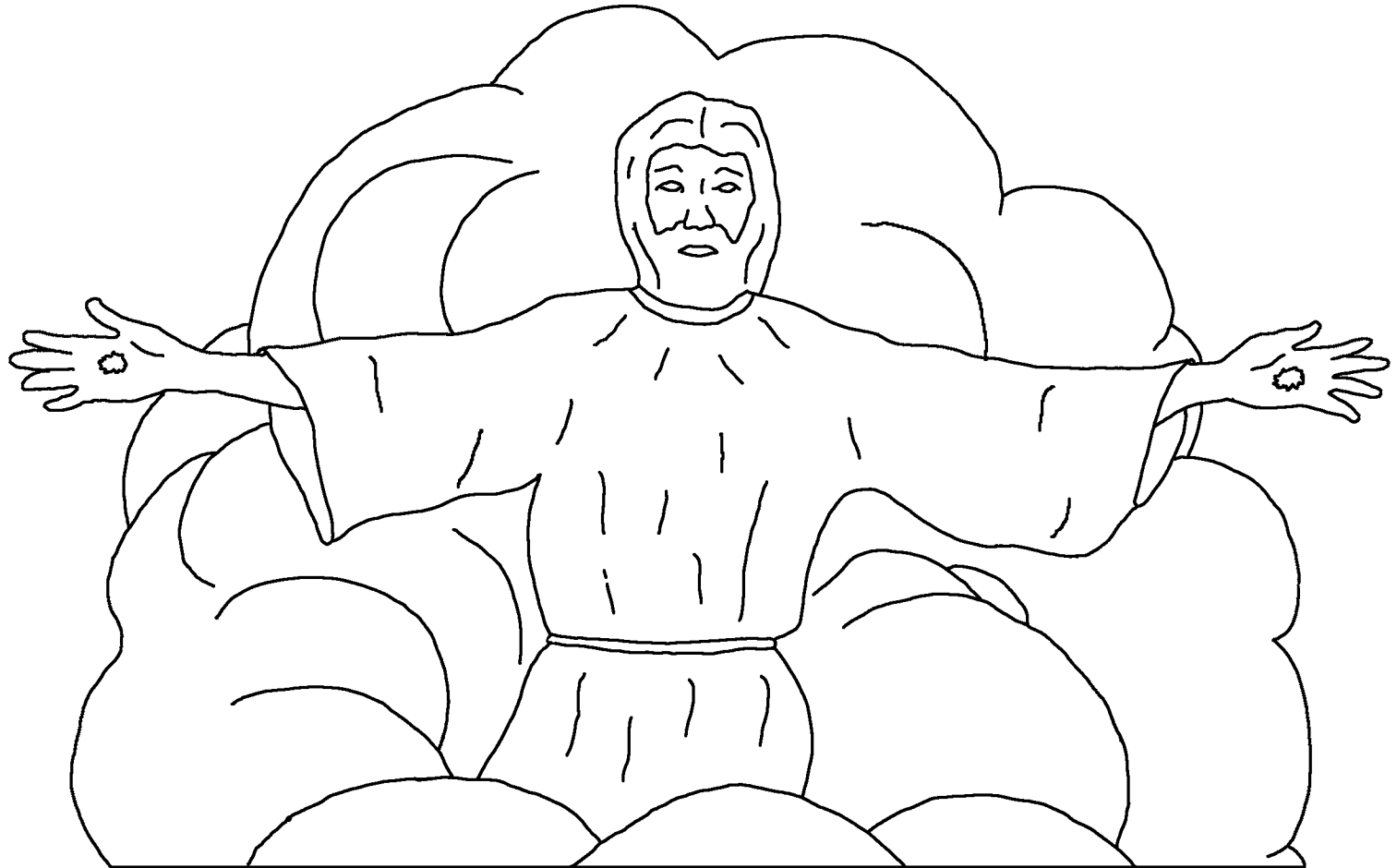

Lenalalutinifita Yonita nani hiti to lenali hiti Yesu
kumu luto keke bake to Hu'mamofihi kapo'agu
to keta'a hiti nasana kofito minolata

nohuta yamofihi lenali hiti moneka liloto
nominonamofita nani

fayahi ya'ma
koyoto
nolepube.

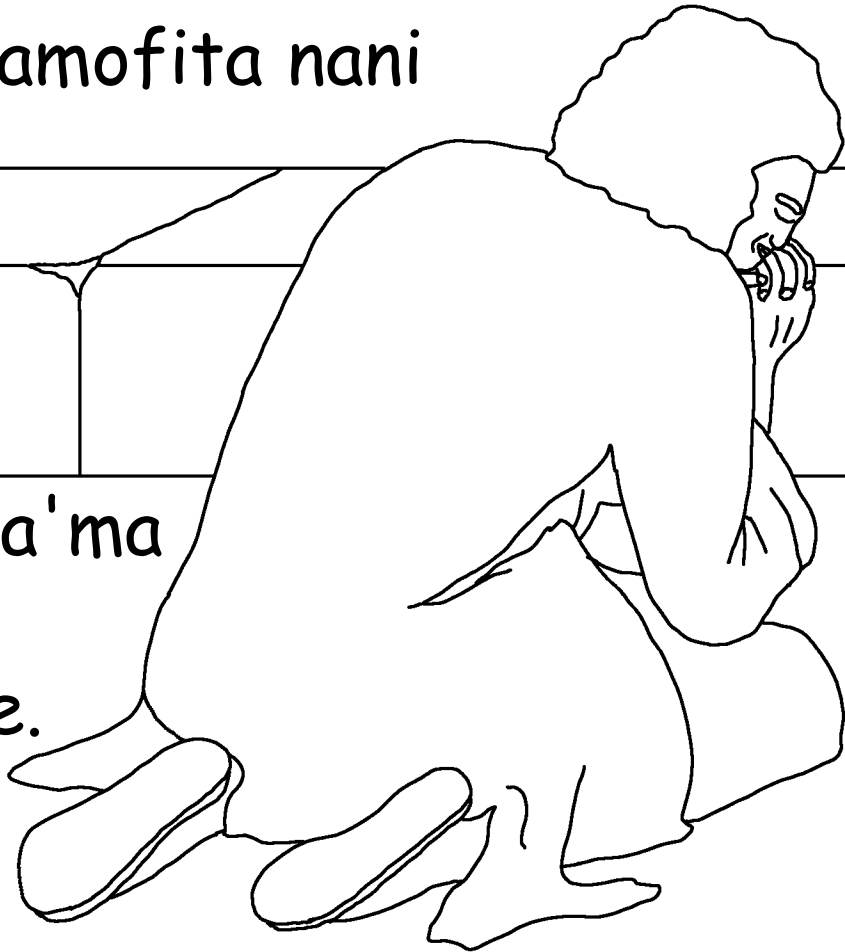

Nani Hu'mamofihi kaga'a to Yesuhi gi'a lu huto
huto luna'mu luto Patamosi metoga hege
nagamilugu ti'ehinalo noho lifigo

he'mito nohuna.

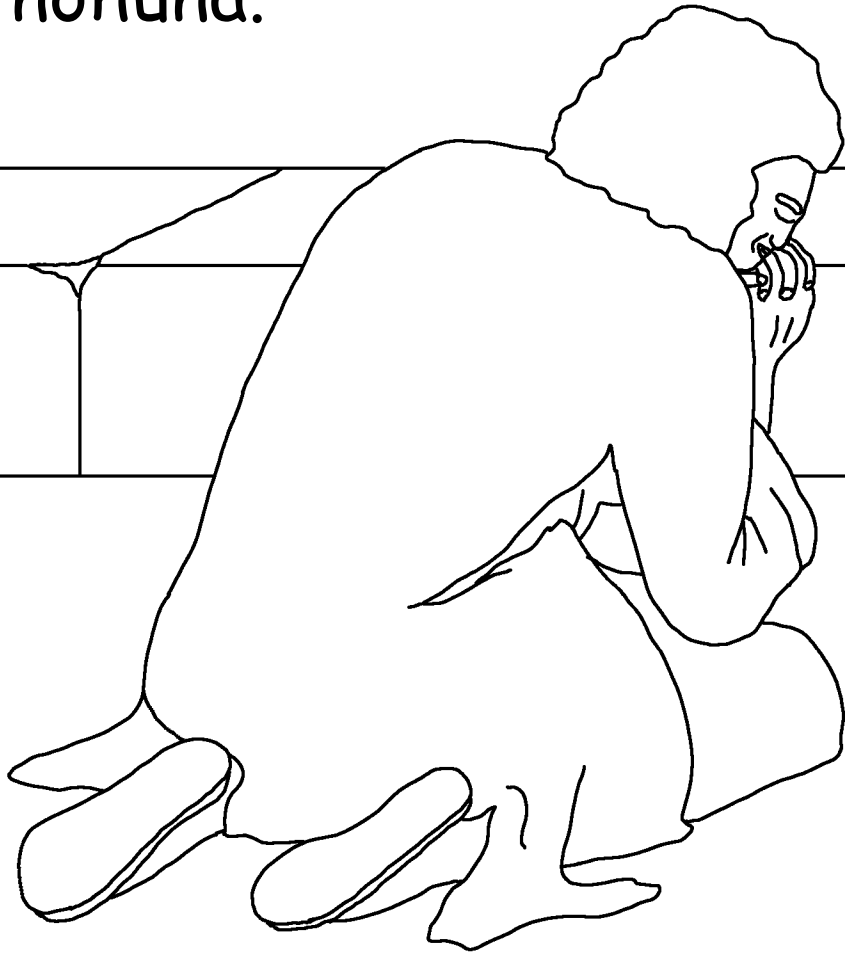

Ya luto lulago ana'asi Sikalafu'uba limito nele'mo
saga tigo kokulumagu sekele mamu'a hiti kefa hisalo
mino'ehinamofihi gupisalo bo moneuba nohigo bu
go'ohuna.

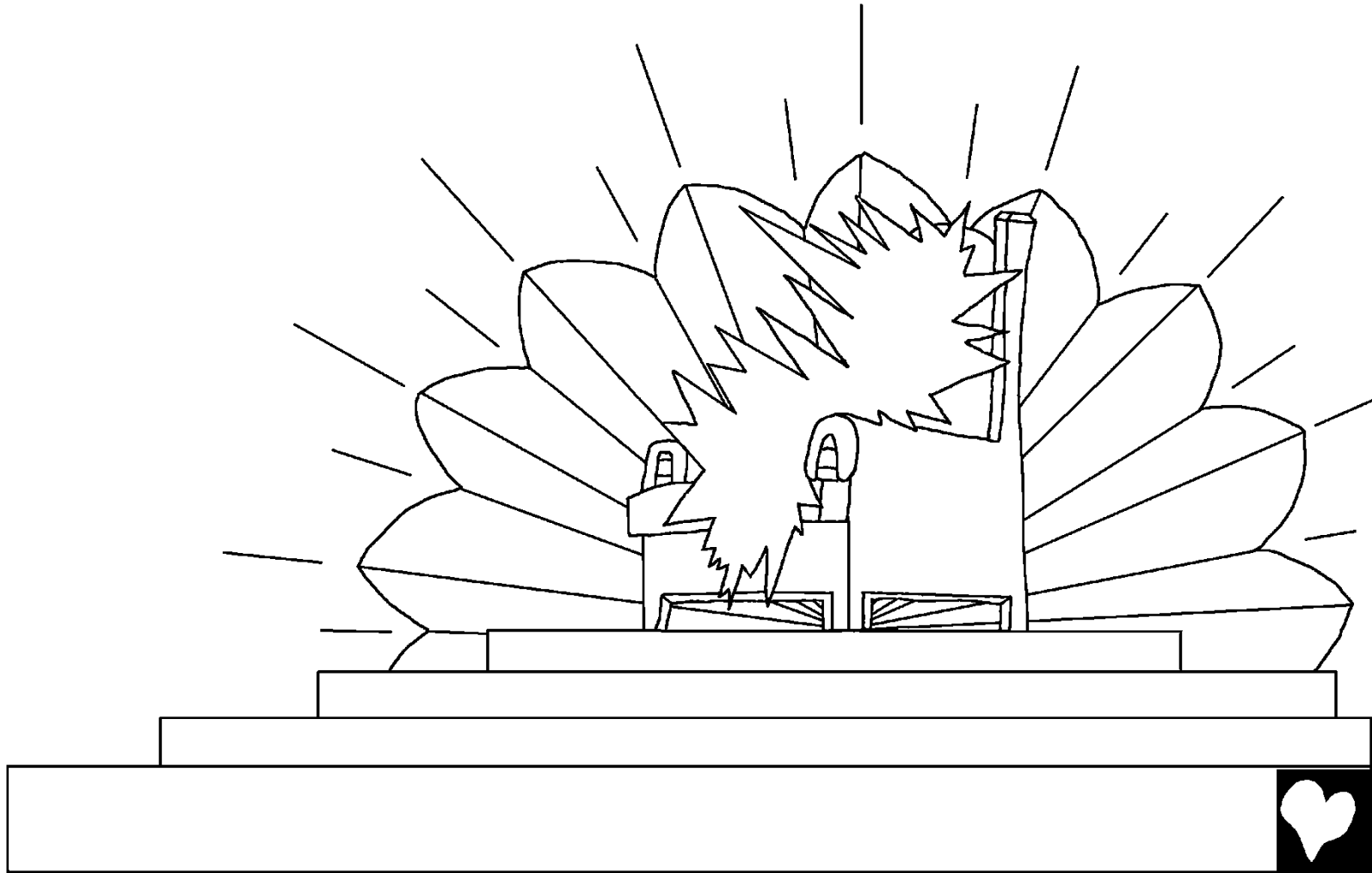

To nani silaga kene'i kokulumagu ni'ina nasana
to melugu ni'ina nasana to me'i komopa'agu
ni'ina nasana to hege nagami'i
komopa'agu ni'ina nasana to
me'i fato fato ni'ina nasana
yege yege'magi ma
lite nama nelago
keheli'ohuna: ...



... Sekele mamu'a hiti kefa hisalo minolata nohina to
sipisipi nala'a nohina etali kumu enofokehi hete
etigi'atiti le'mo ho tilete fana
meha'atiti huto huto hibe,
mino bati hulatana to amuya
etalitoga minomo buto
mino bai toto
minalube'mu
hibe.

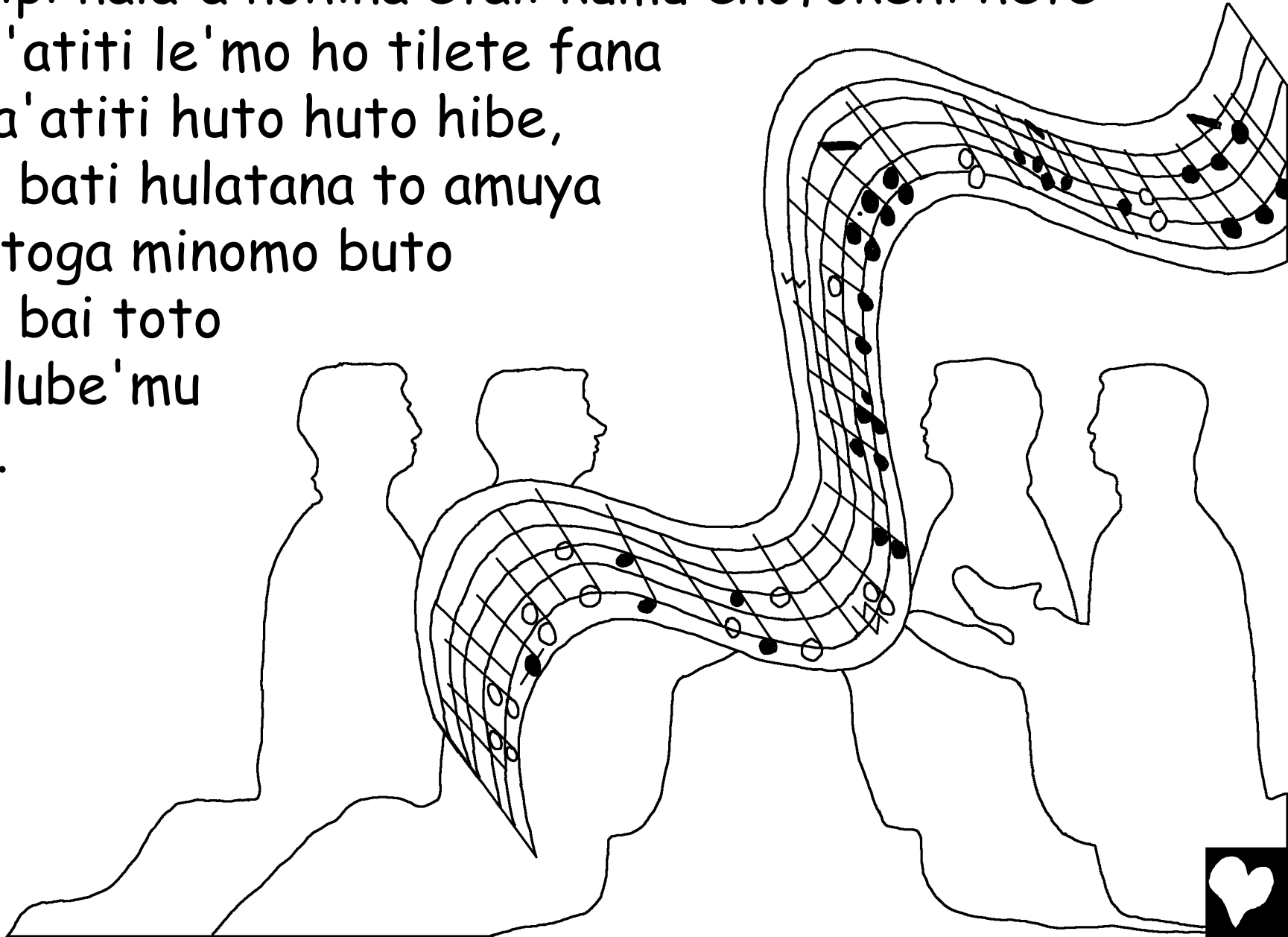

To lamana hepa'i Yelusale yuhufa ya'ma kokulumagu
Hu'mau nohinagati nolimigo bu go'ohuna ya'ma
mone'mofitogati a'i le'mo emilune'mu sekele mamu hi
etelago kata hilata yupahi mino'ehina ya suhi huto
ni'igo bu go'ohuna. To sekele mamu'a hiti

kefa hisaloti
nogo'a sipi ma
luto malago
keheli'ohuna:
Hu'mamofihi nohi
hepa'a ya'ma
bona'magihi enubulo
huto nohibe.

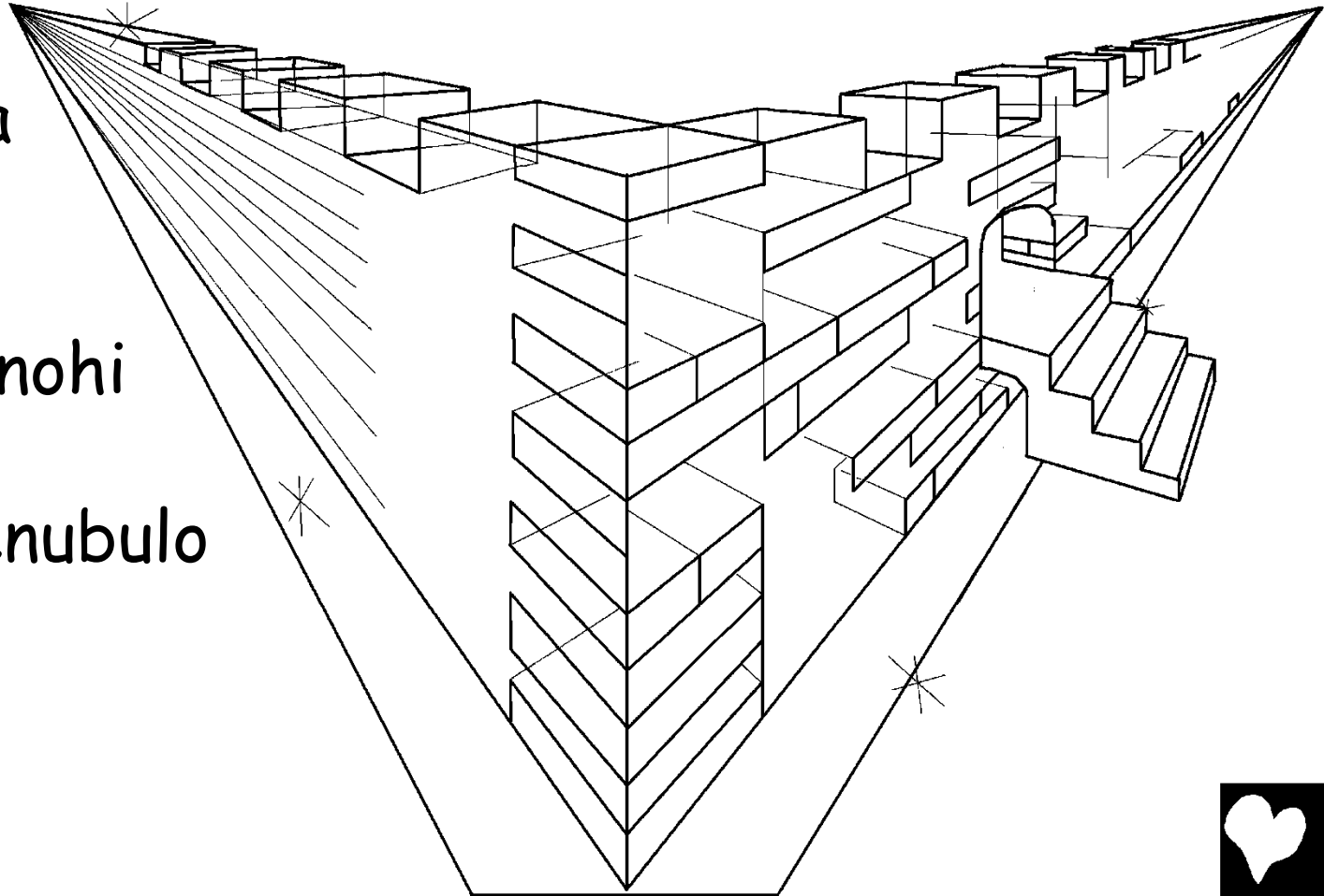

Ai enali hiti moneko babeyafa huto minoto lito hinogo
enali ya'ma bona'a yagapana'a lolo hite minalune'mu
habe. Ai'a enalitoga mino moloto minoto Hu'mau
afo'anifu minalube'mu hibe.

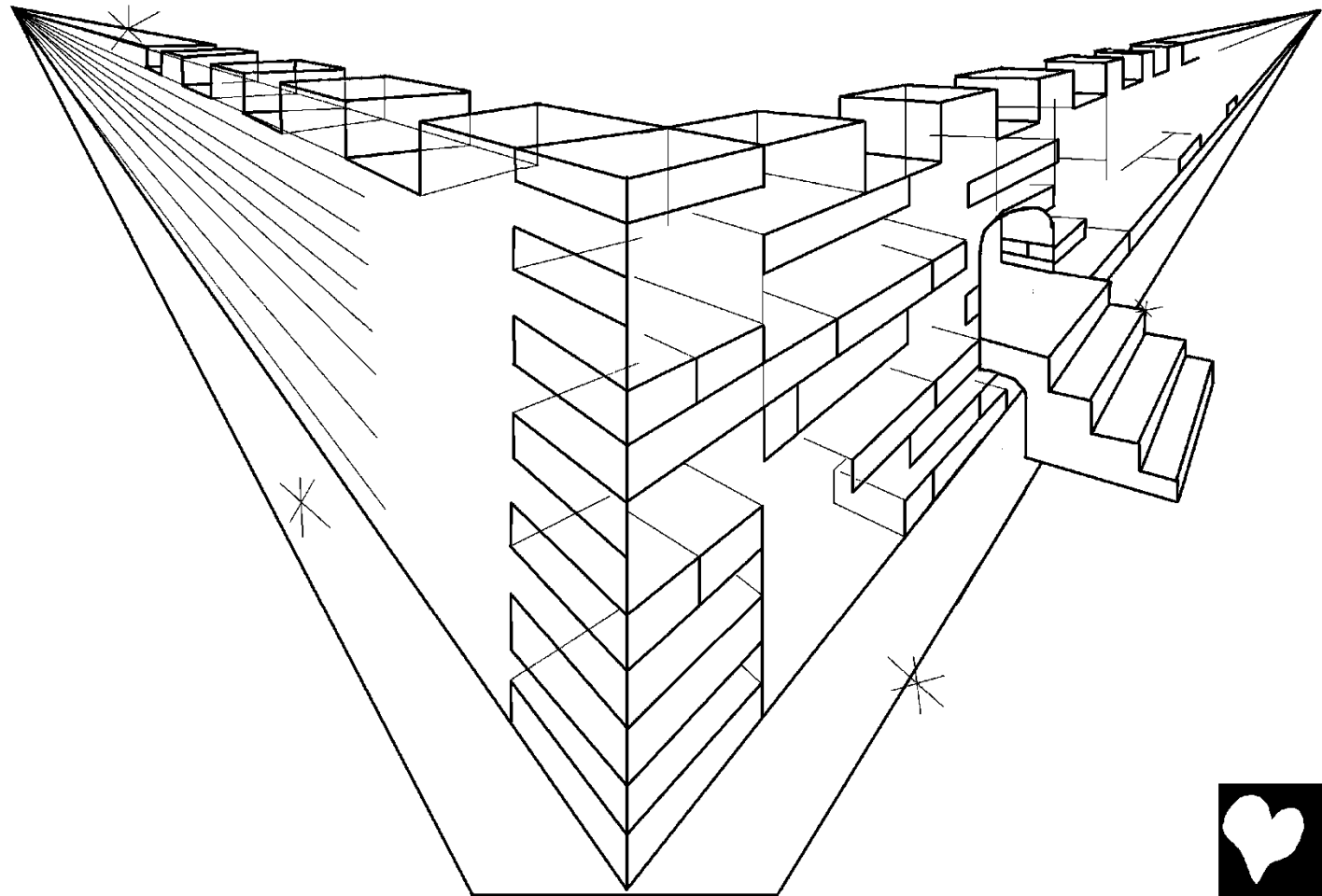

To agelo ai mino kosaba huse nagami'i napa'a biya nonuhu suhi mone nelepigo bu go'ohuna. Ya'ma bu'a gili gili huto ni'ina to Hu'ma to sipisipi nala'a etali sekele mamu'a hiti kefa hisa maha'alugati ya'ma nagami'i nobuto, hepa'mofihi kapo folaganugu nomobina.

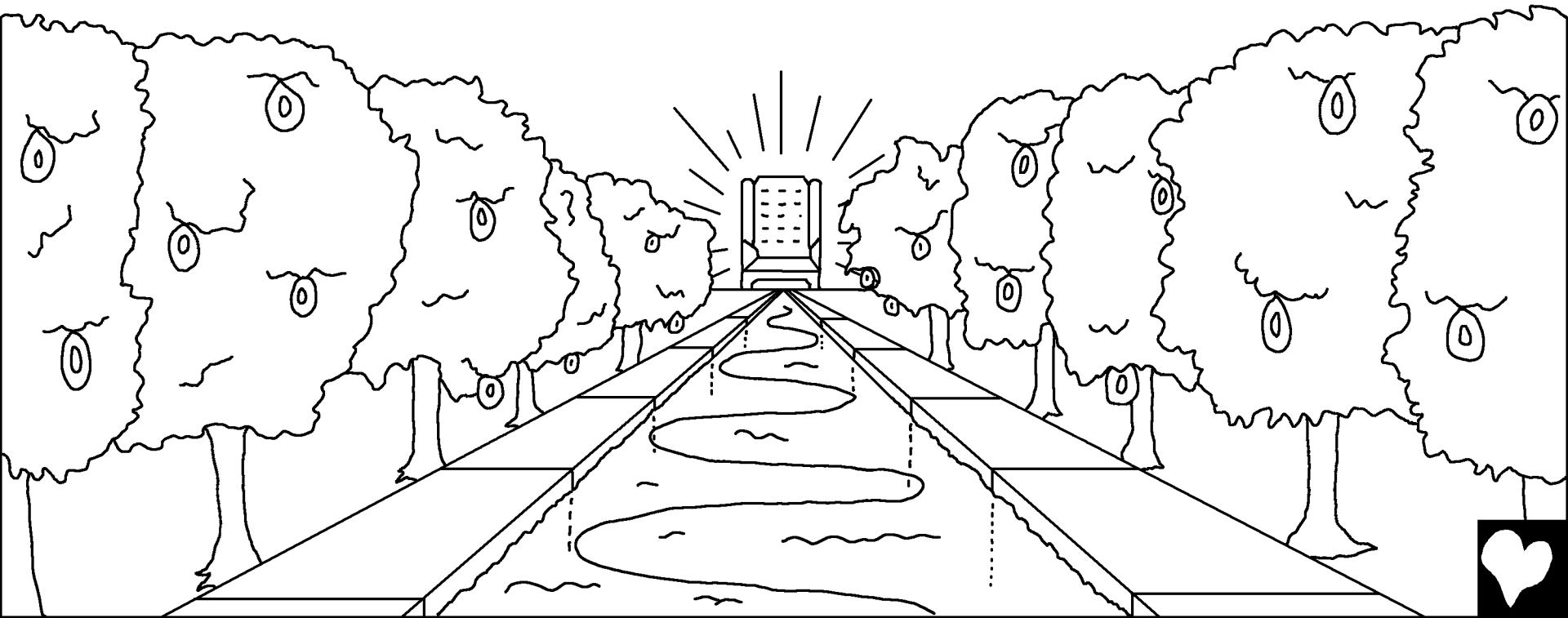

To ana hepato ikahi yegemofihi fana meha' auba
fi besa lalina foya' a meni' ibe. Hu' mamofihi
sekele mamu' a hiti fana meha' auba fi besa
lalina' mu yabe. To ai sipisipi nala' auba libi' i lolo
huloto minalube' mu hibe.

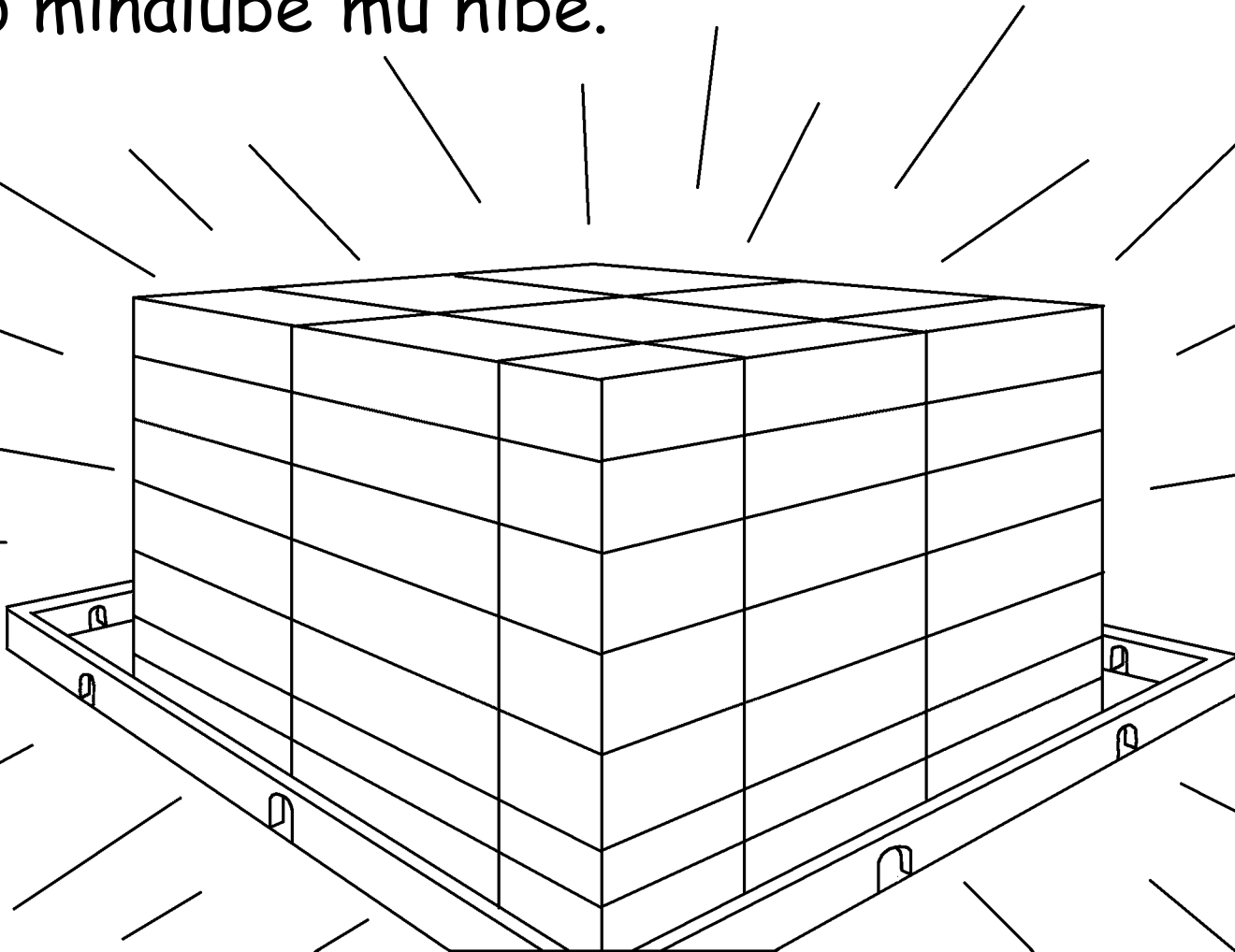

Kolo tanana mone ya'ma anagu tito mefalalina' mu yabe. To bona'i mone'amagi enubuya nohina nasana mone lilana to faga faga lite nehilana'a enali ana hepallugu tite meminalana' mu yabe. Enigi'ani Hu'mamofihi sipisipi nala' auba bati hi' ahana'a minoba minoba hise bona' magihi enigi'ani bukugu koyo molo'ehina bona'i enali'anisigo bite henetilana' mu yabe.

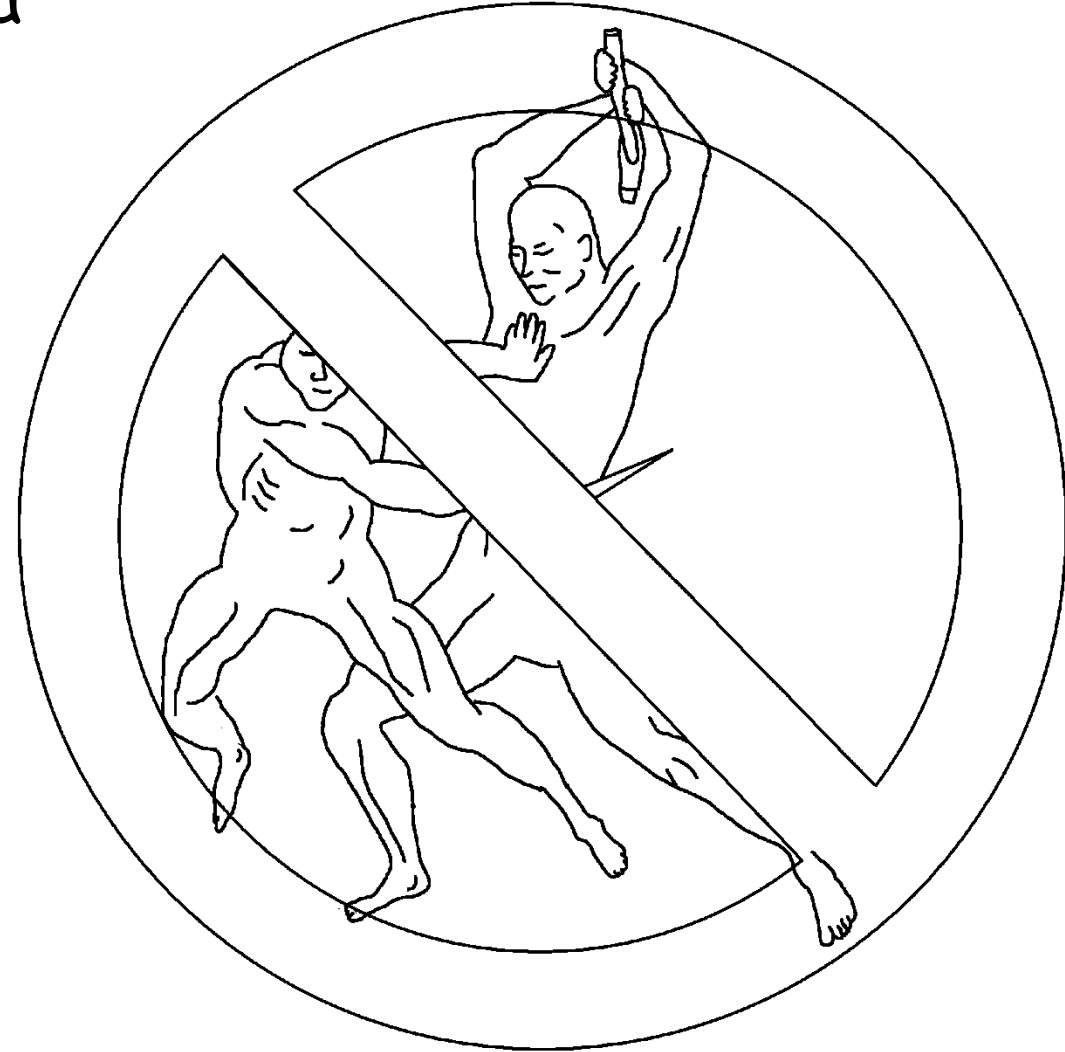

Hu'mau ai'a enalitoga yibi hise nasanamofihi
enubu nogoya kele li epalalube'mu hibe. Filise'na
to yibi bena hise'na to enagabu'i gise'na
yanana su henogo aku'i mone'a huto
mehilube'mu hibe. Tafa nasana
ya'ia'a ya'ma buto su halibe
luto lu'ehina.



Ana hepato ya'ma Hu'mamofihi gumi ho'ehina bo
mone metilina'mu yabe. Hu'ma ai to sipisipi nala'a
etali sekele mamu'a hiti kefa hisa huto hulenogo
bona'a kele kele'amagi enali agoya hi etete
minalana'mu yabe. To
enali okaba'a be
gelete minalana'mu
yabe. To gi'amofihi
fayaha'a
enogobisalo
huto huto
minalube'mu
hibe.



Ya neha'igo fili'ahana bona'i tite minana'a limite
minana'a sekele mamu'a hiti kefa hisamofihi gobisalo
ho tite nehago bu go'ohuna. Kefa hisalo minana bouba
buku mone li paka soloto mino'ehina. To mone buku li
paka sago bu go'ohuna ya'ma amuya minoba minoba
nehana bona'magihi enigi'ani koyo
molo'ehina buku mino'ehina. To
filite bi'ahana'amagi enali
hite melete hi'ahana
suhi ka lamana'a
ya'ma bukugu keye
mele'ahana ya'ma
Hu'mau bu goloto
kaga'ani libe sibi hifi bati
hifi loko huto mino'ehina.

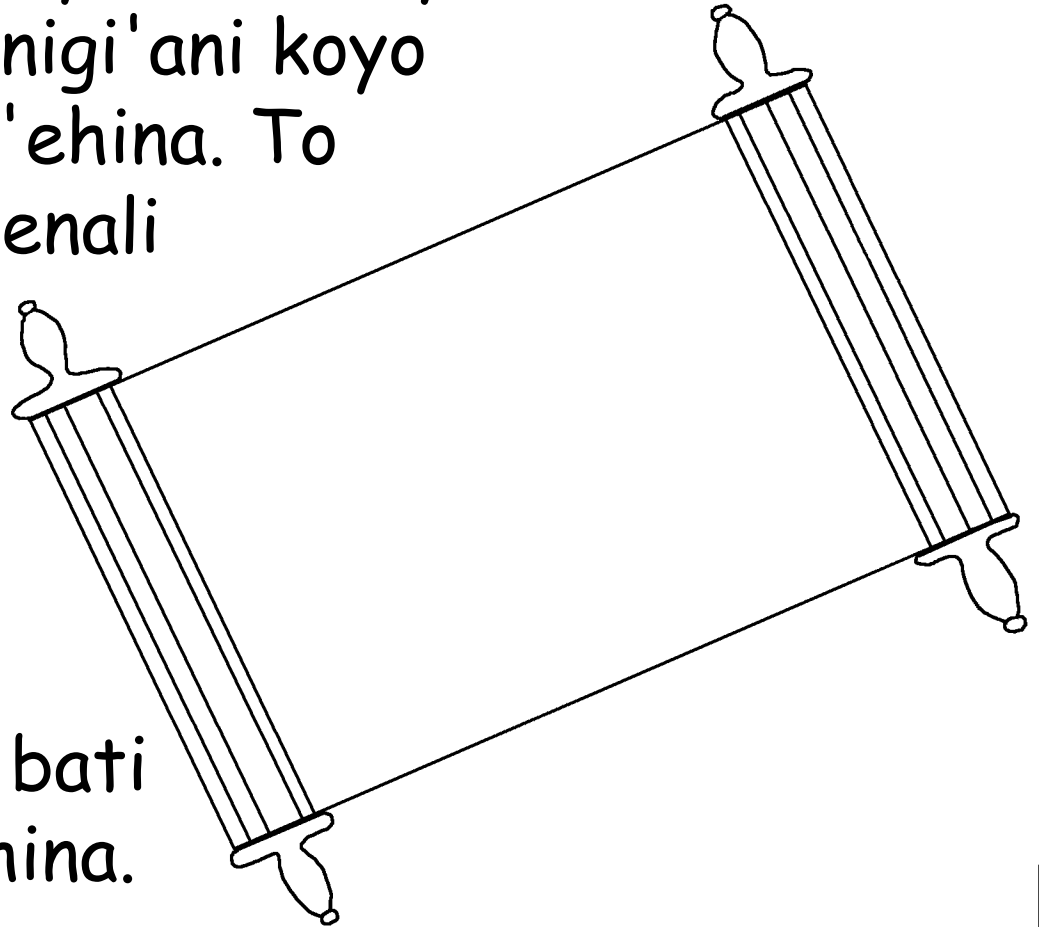

To ana bona'i ya'ma enigi'ani amuya minoba minoba
nehana bona'magihi enigi koyo molo'ehina bukugu
meni'ina'a enali ya'ma logomofihi hefuha'agu kala
efahi logogu loto ni'inagu fitu fo he'migo limite
mine'ahana.

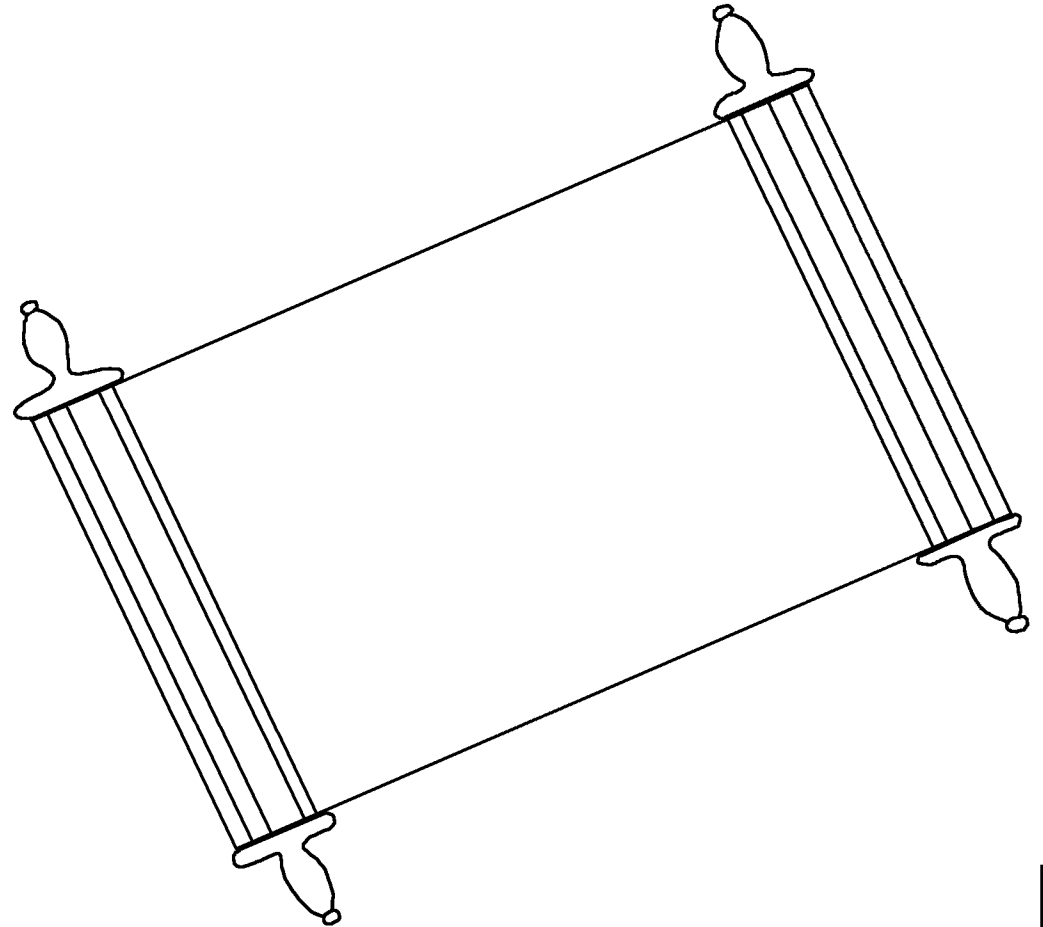

Hu'mamofihi Sikalafu'a to ai sipisipi nala'amofihi
liha'a hiti: Kai obo, lilete nela'ibe. To luga'amagi ka'a
ya'ma kehelilete ana hite ma lite lilabe: Kai obo.

Luga'amagi minoba minoba nasanamofihi nagami kumu
noepesinogomo magati ete hefite nalabe. Enali nalune

litemo ete
magati
nagami'i

mina'a
meni'ina,
fa'mene nalabe luto:
Nanitoga alo,
luto Yesu ya lu'ehina.



Hu'mau ma
melugu bona'i asaga
kumu laga'a besina'mu luto sipi ginaga
nofigo gi moneko pana'asi ho lifigo
limi'ehina. Asaga bona'magi aitoga
keheli ule'ale hite komopa'ani
molo emite mefililana minoba
minoba hilana'mu
yabe.



Romu 3:23 Hiya huto moneko babeyafa nehabe? Lali asaga bona' magita foipana li' ohutogo Hu' mamofihi fana mehena'a meliluta' mu ana' alo i fetaga hu' ohune.

Romu 6:23 Foipanauba ai' a koko pana' magihi lili' nalo nona' a epilata nohinaya filise' na yabe. To Hu' mau fa' mene limilinamofihi ya mino kosaba huse' i ni' ibe. Ya' manamofihi Sipi Boti Yesu Kilisito hiti lele' mo hepito moneko' na liluta' mu yabe.

Hibulu 9:27 Silaga bona' magita kana' a moneko' i fililune luto to yanamofihi ifo' alo Hu' mau nohinalo ai' a foipanati' mu ka foya lilube luto lu leto' ehinamo ni' ibe.

Efeso 2:8 Nekehelifiye? Hu' mau lali hetofa suhi huto minolatanatilo lubuto bina meni' ibe. O' e, ai' a ginaga fi leto' ehinalo agoya hu nimilata nehana' mu yabe luto lubuto bi' ehina ni' ibe.



Efeso 2:9 To ya'ma agoya hu emutana laliti meni'ibe.
Ai Hu'mau fa'mene lele'mo ya huto hu'ehina yabe.
To ya higo hena hena foya lito minenogo ya'ma suhi lolo
hu leto'ehina ni'ibe? Yamofihi meni'ibe. Yamofi
kumu lugufa lelito tise'namofihi meni'ibe.

Romu 10:9,10 To lali mana lu yege nohone. Kai
kabagakaguti Yesu nani kibina bo'ni nohibe luto lilata to
Hu'mau fili'ehinagati le'mo ho ti'ehibe luto komopakagu
ma'naka luto kehelilata nohatogo ai kele'mo bati hinogo
minoba minoba hilane. Lali Hu'mamofitoga keheli ule'ale
hunogo komopatigu lele'mo bati hilibe. To lali
labagatiguti Yesu kibina boti nohibe luto nolunogomo ai
lele'menogo minoba minoba hilune.



Yoni 3:16,17 Hu'mau ma melugu bona'i asaga kumu
laga'a besina'mu luto sipi ginaga nofigo gi moneko
pana'asi ho lifigo limi'ehina. Asaga bona'magi aitoga
keheli ule'ale hite komopa'ani molo emite
mefililana minoba minoba hilana'mu yabe.

To Hu'mau ma melugu pana'a ho lifigo limi'ehina
ai mana melugu bona'i loko hilibe lutogope enele'mo
enubuto bilibe luto ho lifi'ehina yabe.



1 Yoni 5:11-13 To Hu'mau pana'amofihi hapa'a le'mo
hetofa hu etoto ka'a lu'ehina ya'ma ma huto ni'ibe.
Hu'mau amuya lemehi huto minolata nasana li huto huto
limi'ehina ya'ma mino kosaba huse'namofihi
hapa'a ya'ma pana'a nohibe.

To ya higo enali Hu'mamofihi pana'a li pili kete lite
minalana'a enali mino kosaba huse nasana ali'ahanamo
ni'ibe. To luga'a enali Hu'mamofihi pana'a li pili mekalana
enali mino kosaba huse'na ya'ma meli'ahabe luto lilune.

Hu'mamofihi pana'amu lenemehi emi'ahana'a lenali
ya'ma keheli ule'ale huto minoba minoba nasana ya'ma
ali'ahabe. Li'ohune lite keheli fe lite kehelilabe
luto ka'a ya'ma koyo nolepube.



Yoni 14; 2 Koliti 5; Huto Hilina Ka 4, 21, 22

Storyline by: Edward D. Hughes

Illustrated by: Lazarus
and Alastair Paterson

Adapted by: Sarah S.

Benabena Bible (bef) © 1982, Wycliffe Bible
Translators, Inc. All rights reserved.

<https://live.bible.is/bible/BEFWBT/MAT/1>

©2026 Bible for Children, Inc.

www.M1914.org

www.bibleforchildren.org

