

[www.BibleForChildren.org](http://www.BibleForChildren.org)

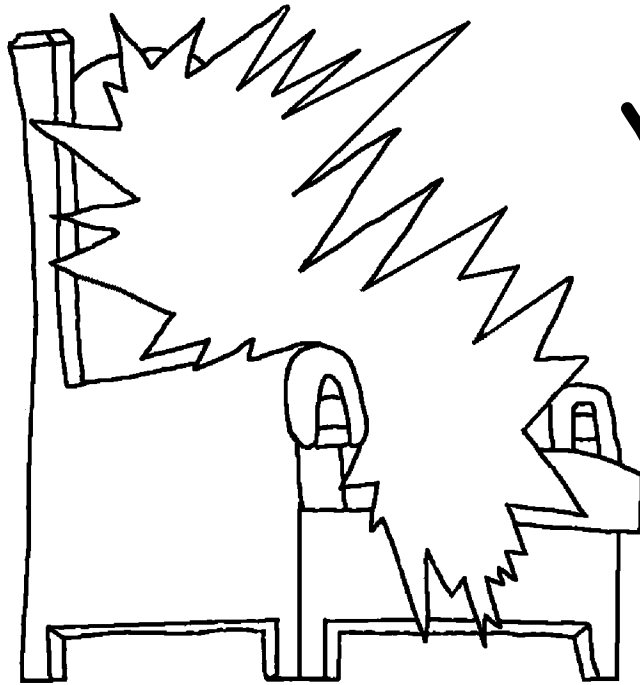

# Yoothane 14



Yisufa miqi qimaseenoo aiqama qimanniminoo  
qinau. Innee sia nimukee marinaqa maparaaiaqa.  
Innee Anutuna saqariki mariafanoo doo qini faqa  
saqarikiqa. Qini qikoona innaaruna maqusaki moomoo  
maqa narí aqa narí aqa maridanoo. Qinee maindari

ooruree innee ooru  
fifandinna

maqana  
auqirara  
ooru  
fidaqa.

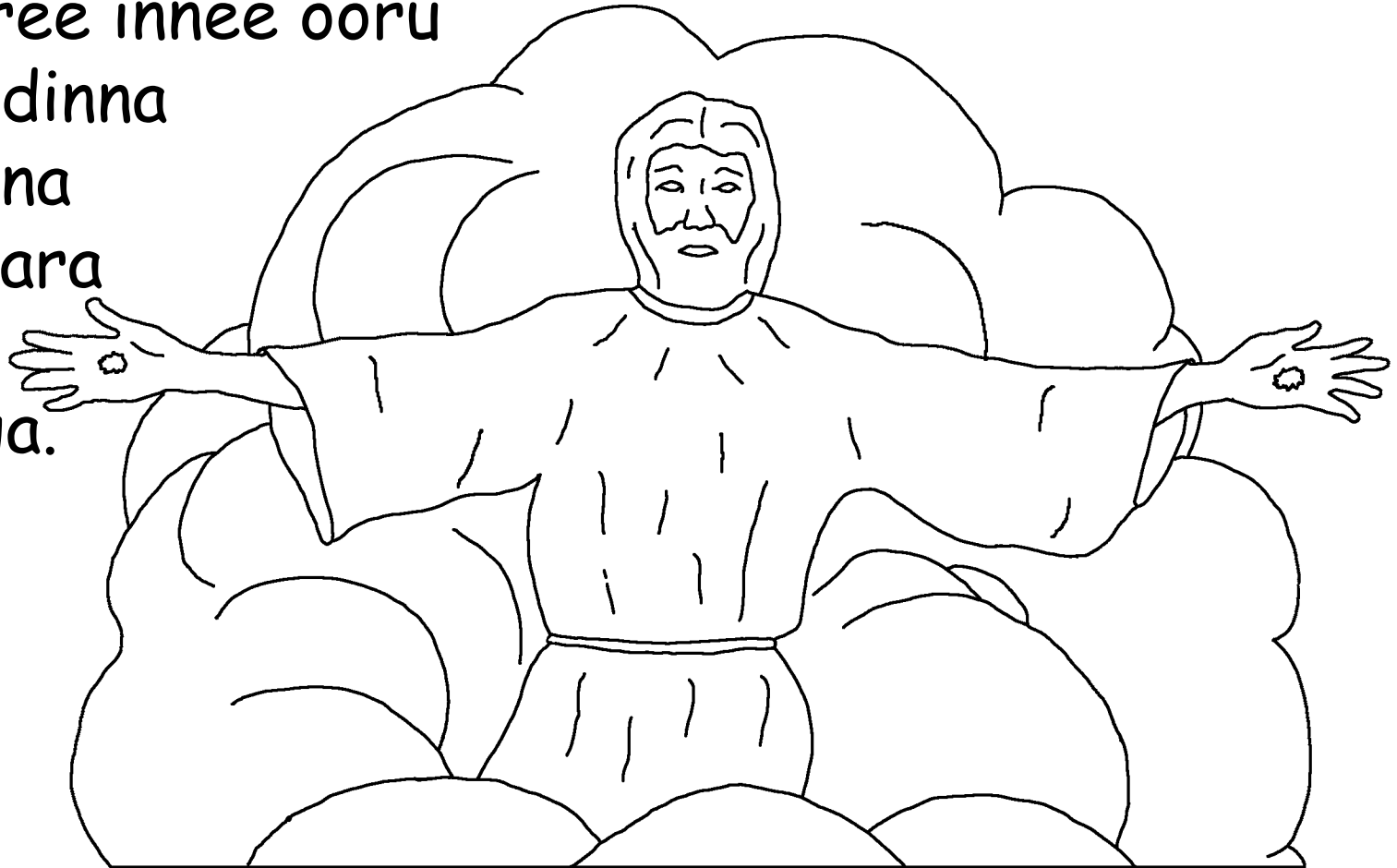

Minara qinee kuqaa anoona ufa kai inni qimannimidaqa.  
Sia anoona marinaqau sia qimannimunaiqini. Kuqaa  
anoona marifaqa qimannimidaqa. Qinee innaarunai  
oorureeqa innee ooru fifandinna maqusana  
deedaqamasee qumu nifiqee minni murunnisaanaura.  
Innee qini faqa  
mariaqeera  
miqianaura.

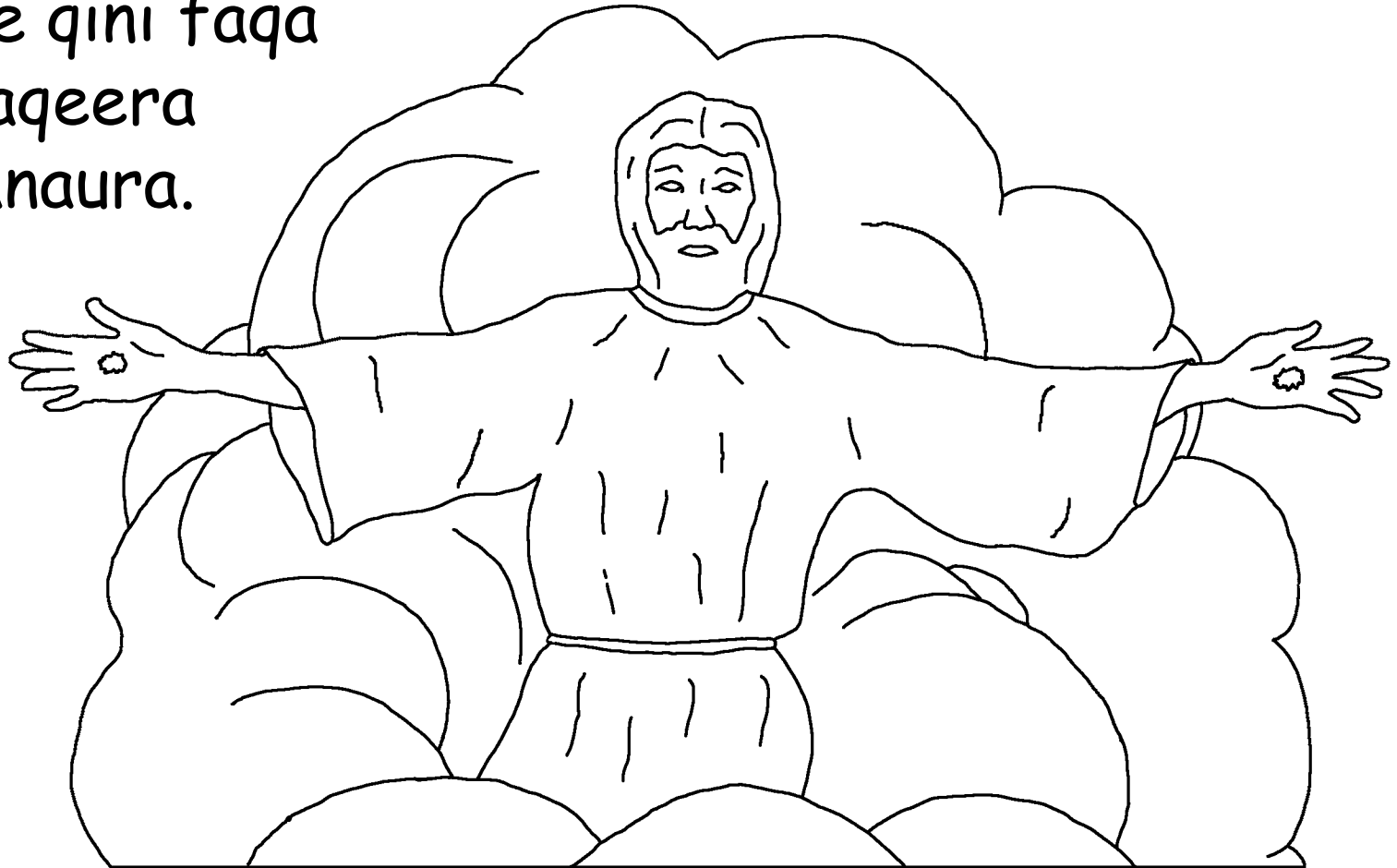

Yoothaneefa narí qafoo ainainna maaqi qimasee  
akara rinau. Qinee Yoothaneesa inni nifasausa  
nauraiqi maridaqa. Qinee innisaimbaqa

Yisuna anoonufa qimannimunaga nári unna  
Anutufa marifaqa kuqaa

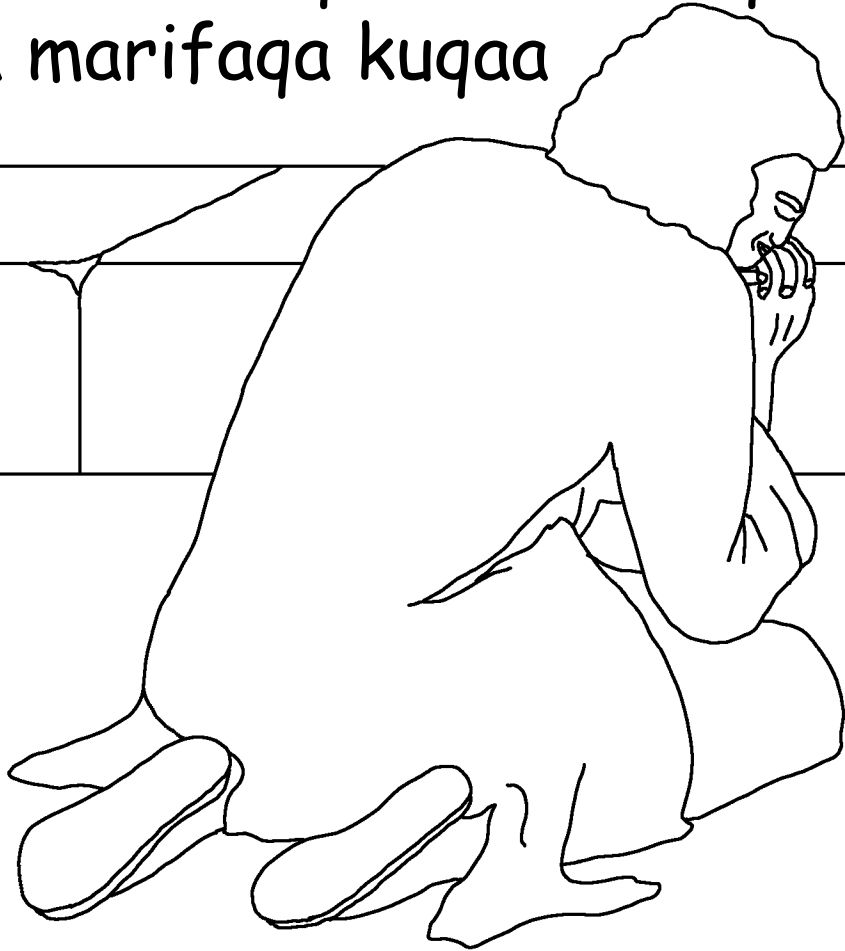

qira Anutunara  
nikooqaifaqa

aupurarana faqa  
narirana faqa  
innisaimbaqa  
qimimariafaqa  
maraidaqa.



Qinee faqa innee faqa Yisuna ququsaki marunausa  
maridaqa, maasa mina teeroo quqaranaki  
maraidaqa sia minara aupureeqa mina

minniseeqa kaqi minaki doori runusee maraqa  
fidaqa, qinee Yoohaneesa

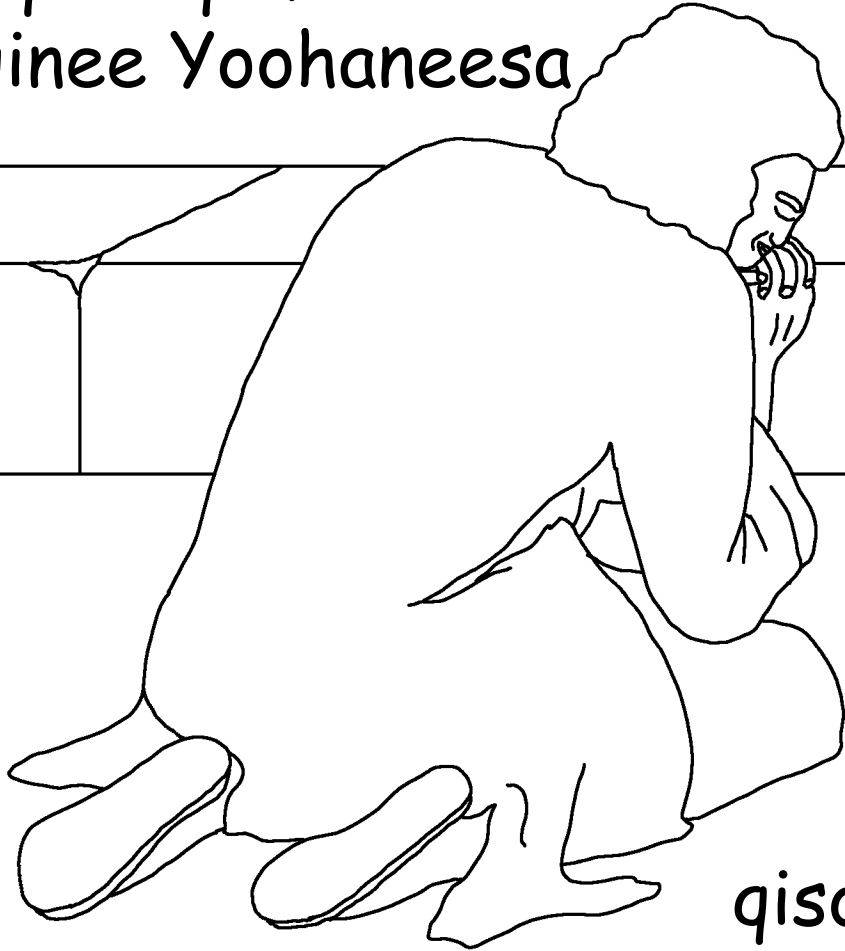

Anutuna ufa faqa  
Yisuna koorooira  
anoonufa faqa

qimannimifannanara  
Roomma maqannaasa  
qini karabusa  
rumbaranaki

qisoofaqa maridaqa.



Ooruku nammari qambaana Patamoosa afumaki  
Roomma maqannaa karabusaki mariaf ananoo  
Yisufa oosana oosana ainaina

kambiqaaninnanara  
qimaqiminau.



Miqi qimasoofanoo Anutuna maraquna daakufufaqa  
kooqiki keeqaki innaarunai ooru fiqiafana. Ooruree  
qafaafananoo ufa irira qaari ufiqiranasaa moo fasiqa  
marufaqa qafaqia. Mi fasiqafa Anutufa marinau. Mi  
qaarifa sia kaiqeesa qaari  
Anutuna nari rakisimari  
qaarina marinau.

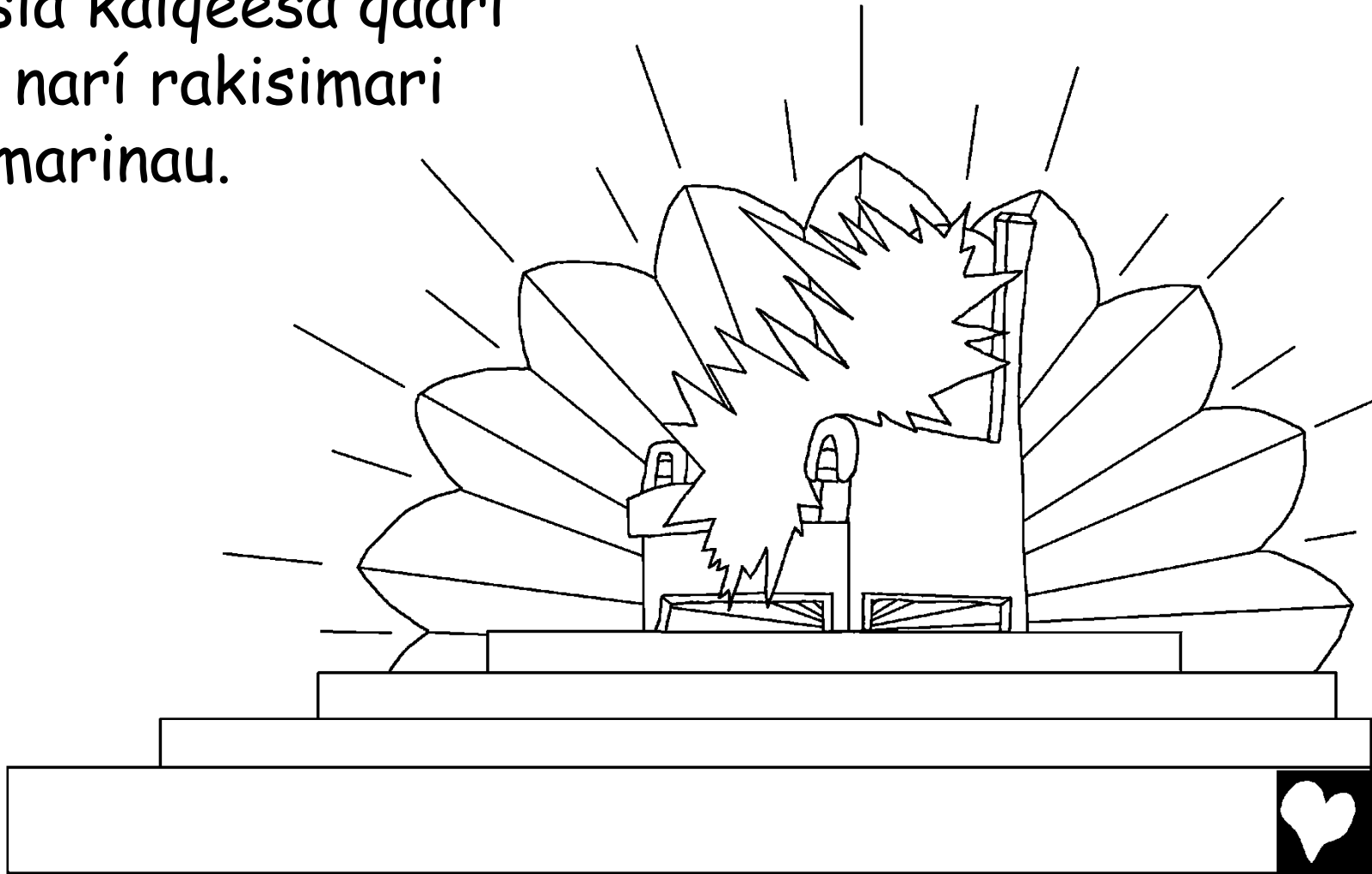

Misa mi idina ramasoofaqa kafaa iriseeqa aiqama  
innaarunaindaraa ainaina faqa maqasaa ainaina  
faqa ooruku nammarikinaa ainaina  
faqa maqa ameemaanaindaraana  
faqa aiqamai Anutufa  
auquqoo ainainausa  
moodaanakikammambiq  
maaqi qimasee  
idi raqau.

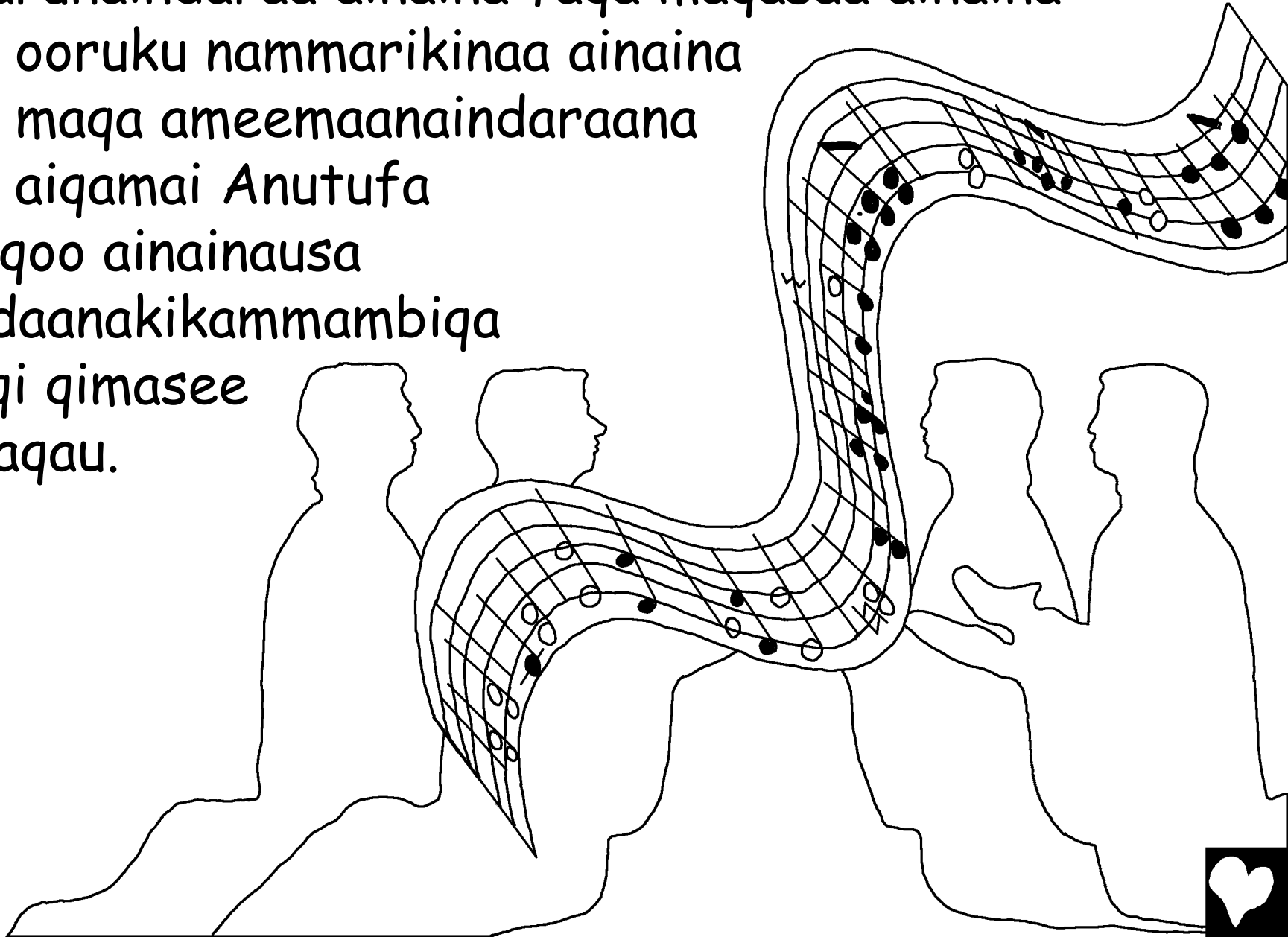

Qaarisaa ooqu marinoo marifa sipsipa aanaaqi faqa  
inniqara nimooqirana faqa nuqu uqeerarana faqa  
areenarana faqa afeeka faqa  
naaru naaru innindi marianifee  
qidaqa idi raidaqa.

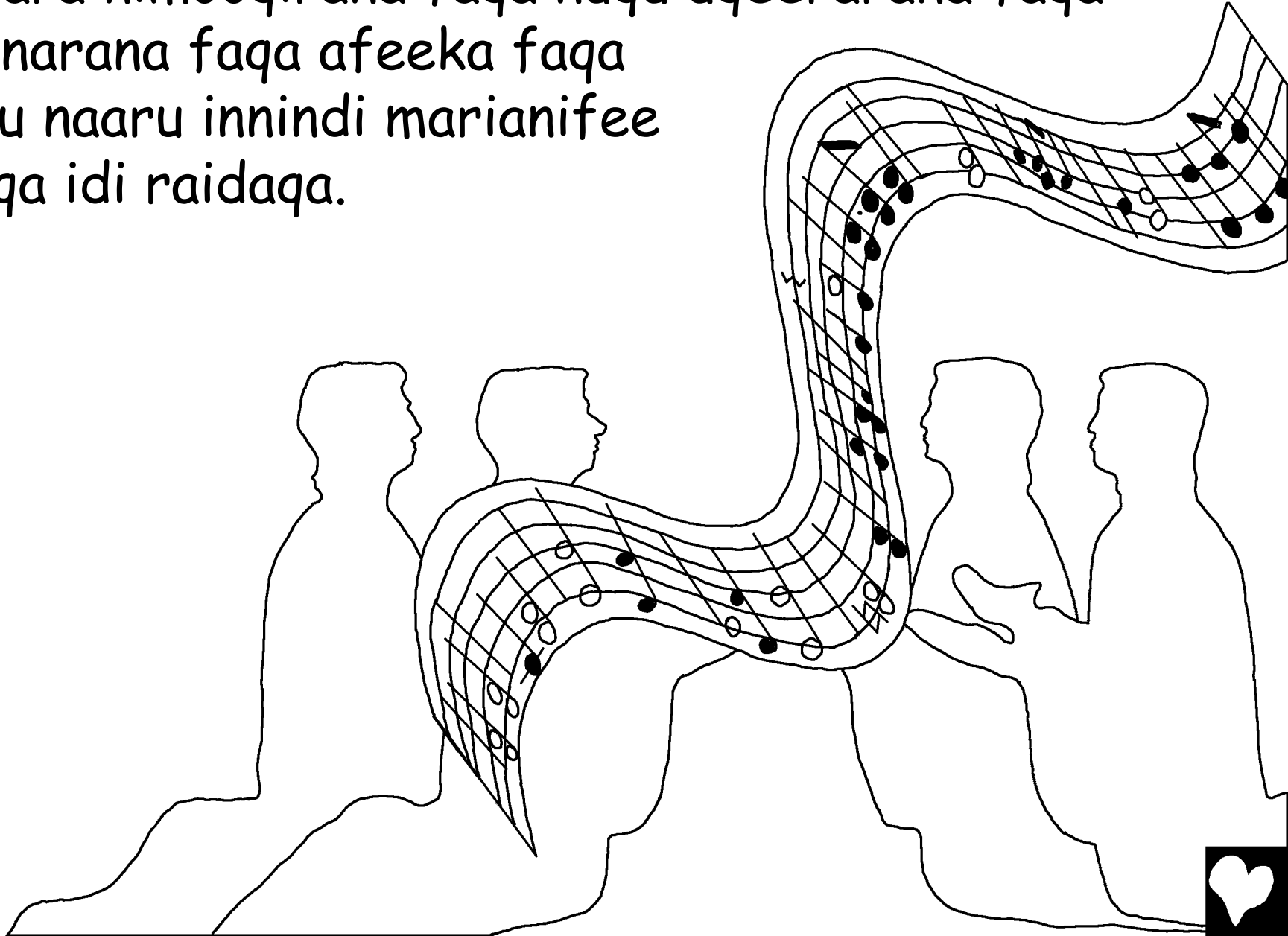

Qinee qafaafananoo Anutufa qufanoo fuka naaquqara  
maqusa fuka Yeerusaree innaarunaindari qumureenoo  
ooqeenaa Yeerusaree amaaga maqafufaqa  
qafaqiafana. Fuka anaasee amundaranara  
foora afaaqa  
auqirafa  
fuka maqasaa  
quminau.

Qumuroofanoo  
ufa moo fannoo  
Anutuna innaaruna  
qaarisaaqari maaqi  
qimasee firaa  
kari qinau.

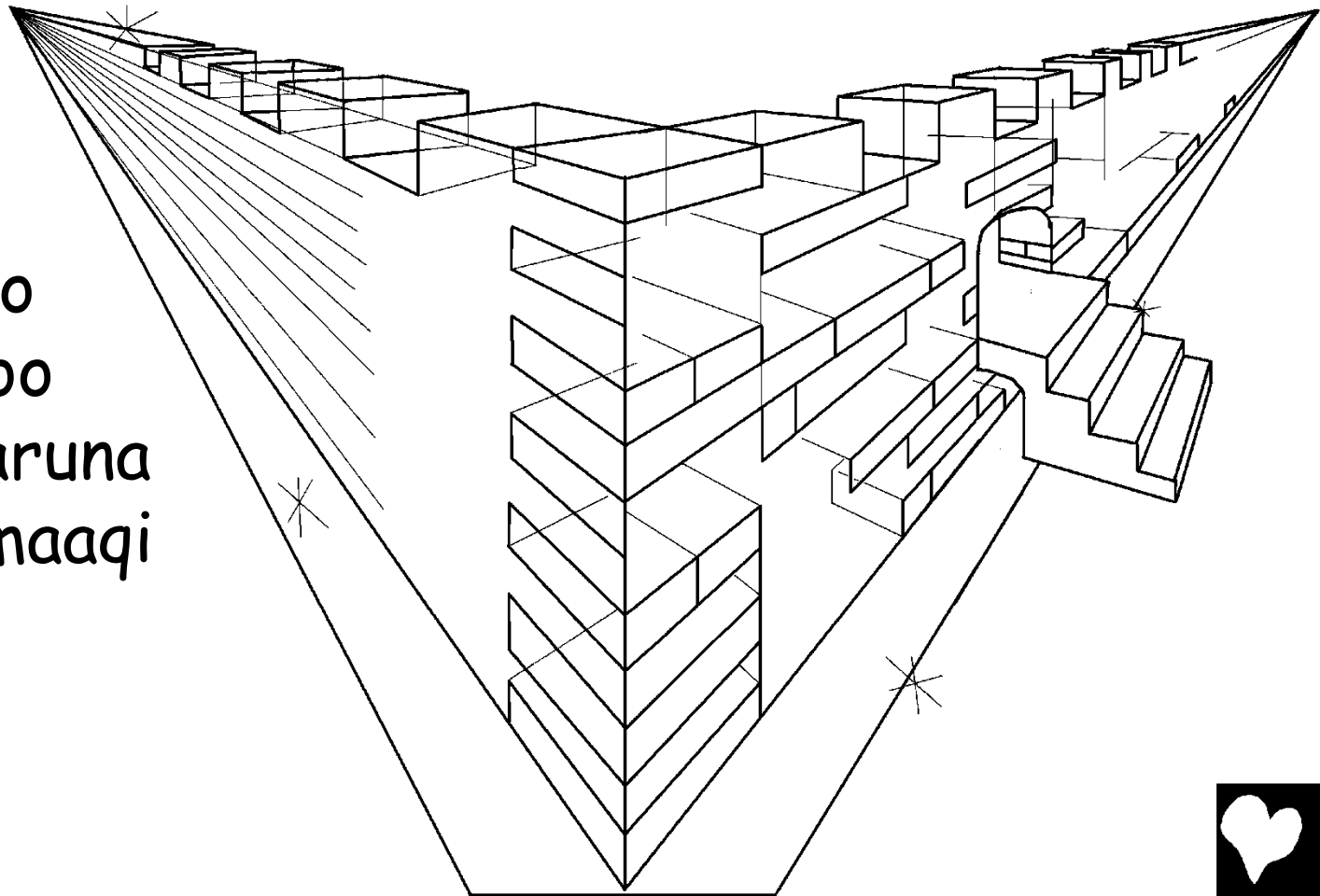

Doo maqee Anutuna maqusa faiqiki qumu maridanoo.  
Mifa misa faqa marinaqa misa mina faiqí anaasee  
marifaranoo. Anutufa narí uqanna misa faqa marinoo  
misa Anutufa mariannoo.

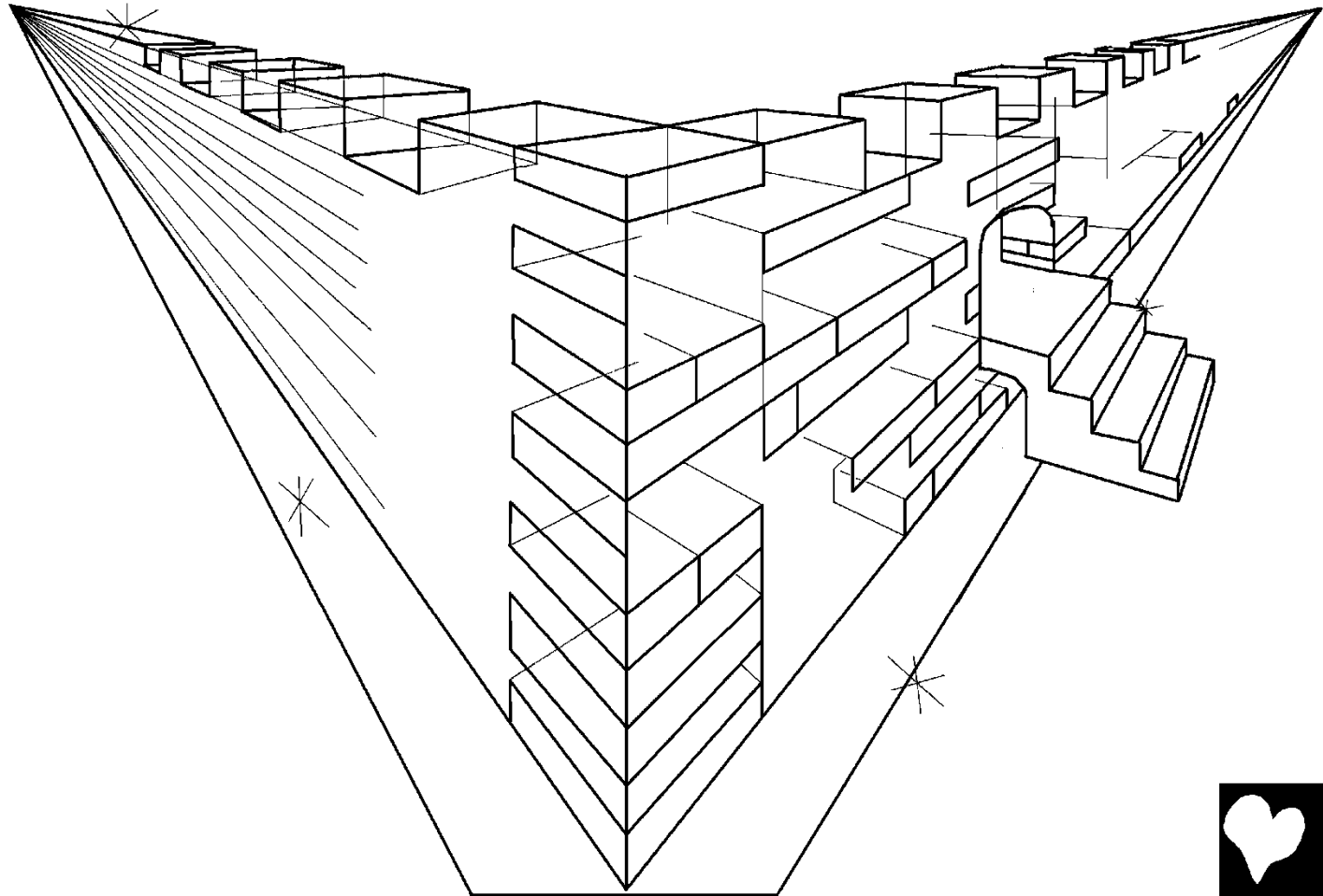

Mi qangiroofa fuka Yeerusaree maqusa  
uqaqifiqaseenoo nammari miqoo maruna uqaqifiqanau.  
Mi nammarifa Anutuna faqa sipsipa aanaaqi Yisuna  
faqa maru qaarinakiqari qumuree fuka maqusa  
qambaana ooqu fimarinau. Mi nammarina auqu kaqi  
marira nammari fee qiqau. Amiqira nammari sia  
dumuna maqa maru nammarifa mi nammarifa  
mookoofa amanee kai randaida  
qumidanoo.

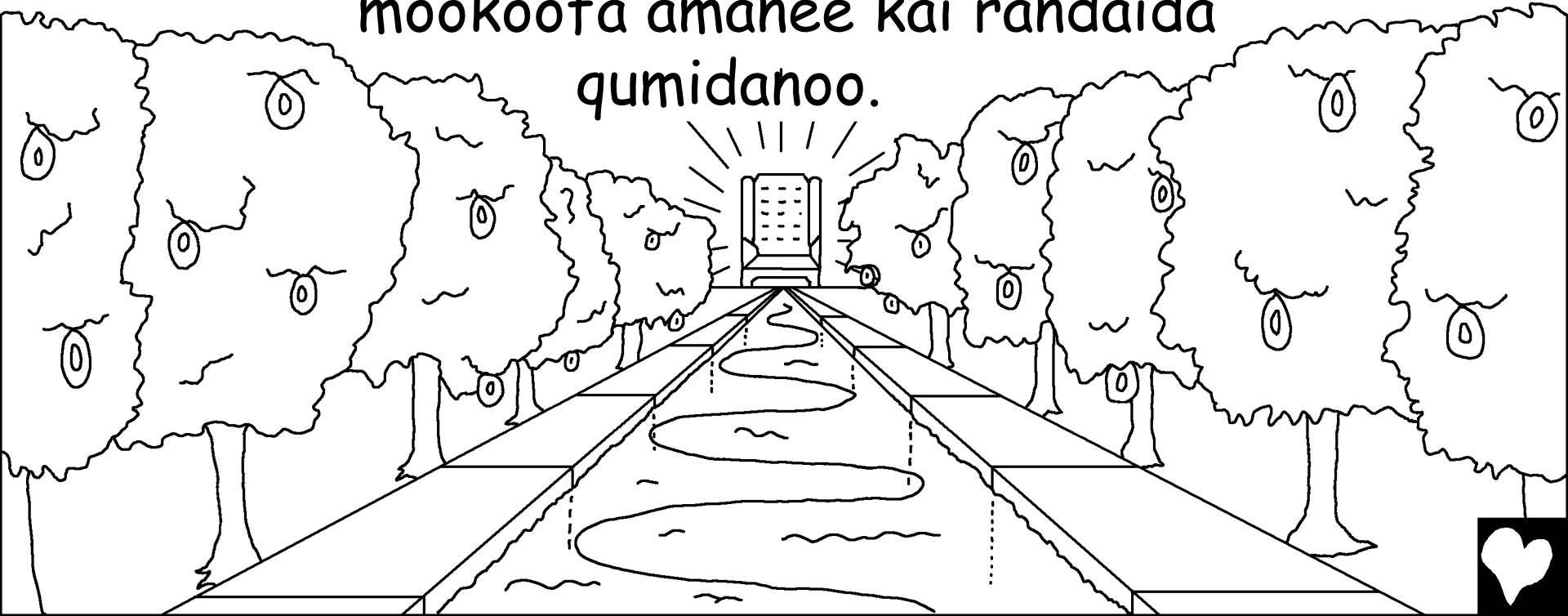

Suani faqa quqoona faqa marinaqau qafani. Sia mari qafeeqa. Maridanoofau fifau mariqini Anutuna narí firaa areenarafa firaaqoo kaaga qamaqinoo maridanoo, sipsipa aanaaqi mi maqusana qoomara foora maridanoo.

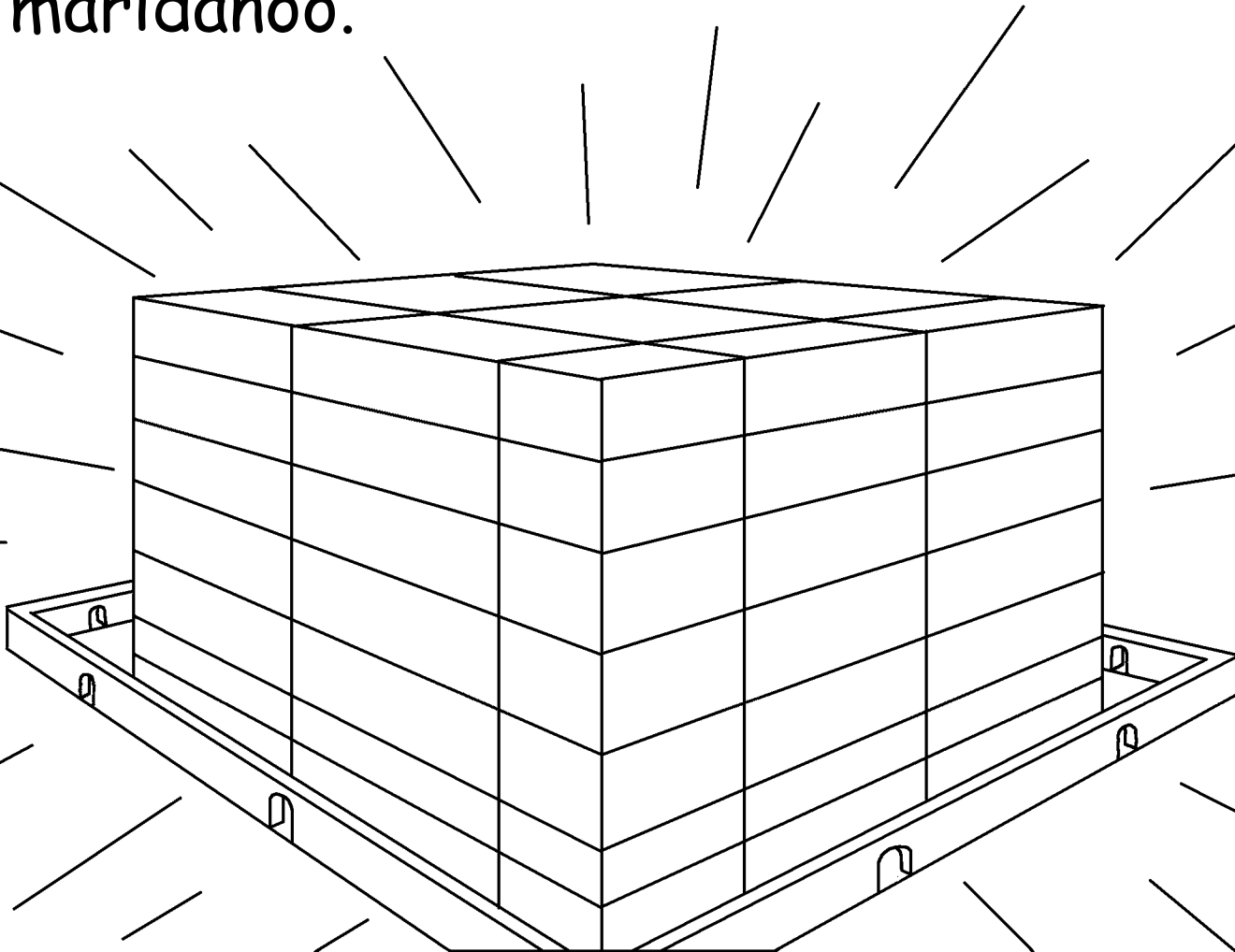

Sia moo manda ainaina  
fannoo mi maqusanaki  
keeqaannoo. Sia moo  
asaurira ainaina auqee  
mari fee unna ufa  
qimari fee sia mi  
maqusanaki  
keeqeefaranoo.  
Sipsipa  
aanaaqi fannoo  
maqasaqaraasa  
narí papiqaki nuqu  
akara rumaqaisa misa  
kai mi maqusanaki  
keeqeefaranoo.



Mifa aigamausa naukunu  
rukaannoo. Sia kafaa kuqirafa  
faqa ikifaafau qirafa faqa  
ikiraqarafa faqa nidafirafa  
faqa sia kafaa mifauqa  
mariannoo. Mi ooqeenaa  
ainainafa doo taikafinoo.



Moo ainainara Anutufa aqurarainna ainaina sia  
mi fuka maqusanaki mariannoo, doo taikafuannoo.  
Anutuna qaari faqa sipsipa aanaaqi qaari faqa mi fuka  
maqusanaki maridanoo mina aiku asauku mi  
maqusanaki mariasa  
mina amooqifaranoo.  
Misa mina oori  
qafeefaranoo misa  
niqinaaqa mina auqu  
akara rinoo  
mariannoo.



Qinee miqoo qafaafananoo kuqirausa aiqama  
kuqiranakiqari findi fiqa Anutuna qaari aaqa ufa  
qiraree qimasee kikiqiga mariqau. Uriqararausa  
faqa oorudupirausa faqa amana amana kai Anutuna  
oorisaa kikiqigau. Innaarunai mariasa mi  
kuqirausa akara papiqa qairiseenoo  
nisaana riqau. Papiqa moo kaqi  
mariasa nuqu  
papiqa faqa  
qairisee qafanau.

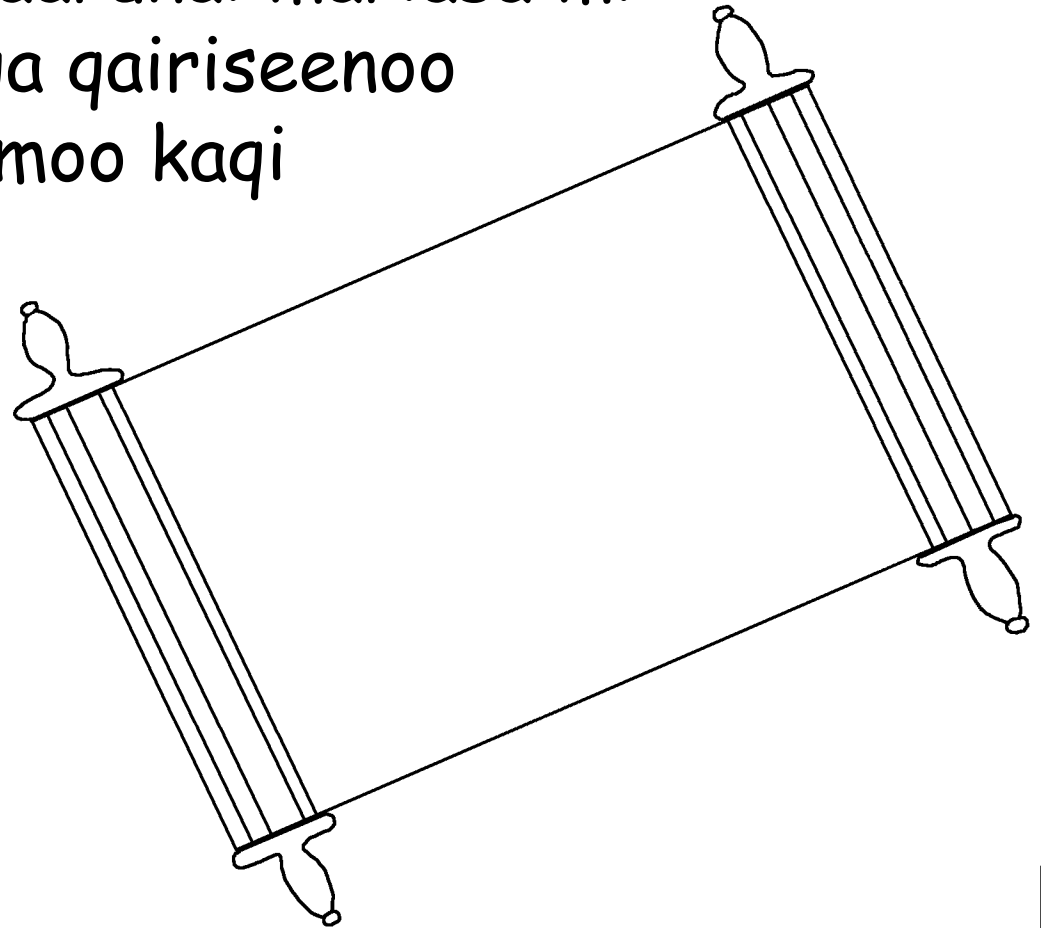

Anutufa mi papiqanakinaana misa manda marirana  
nirana auqarana qafamaseenoo ufa mina amana kai  
nimitau. Aiqamausa asumu maraaninausa papiqaki  
nuqu marisa misa kaqi marifaranoo mi papiqanaki  
nuqu sia marinausa misa aiqama  
mareeqee kaqi kasi marufanoo  
ida farumaki aiqama aqinau.

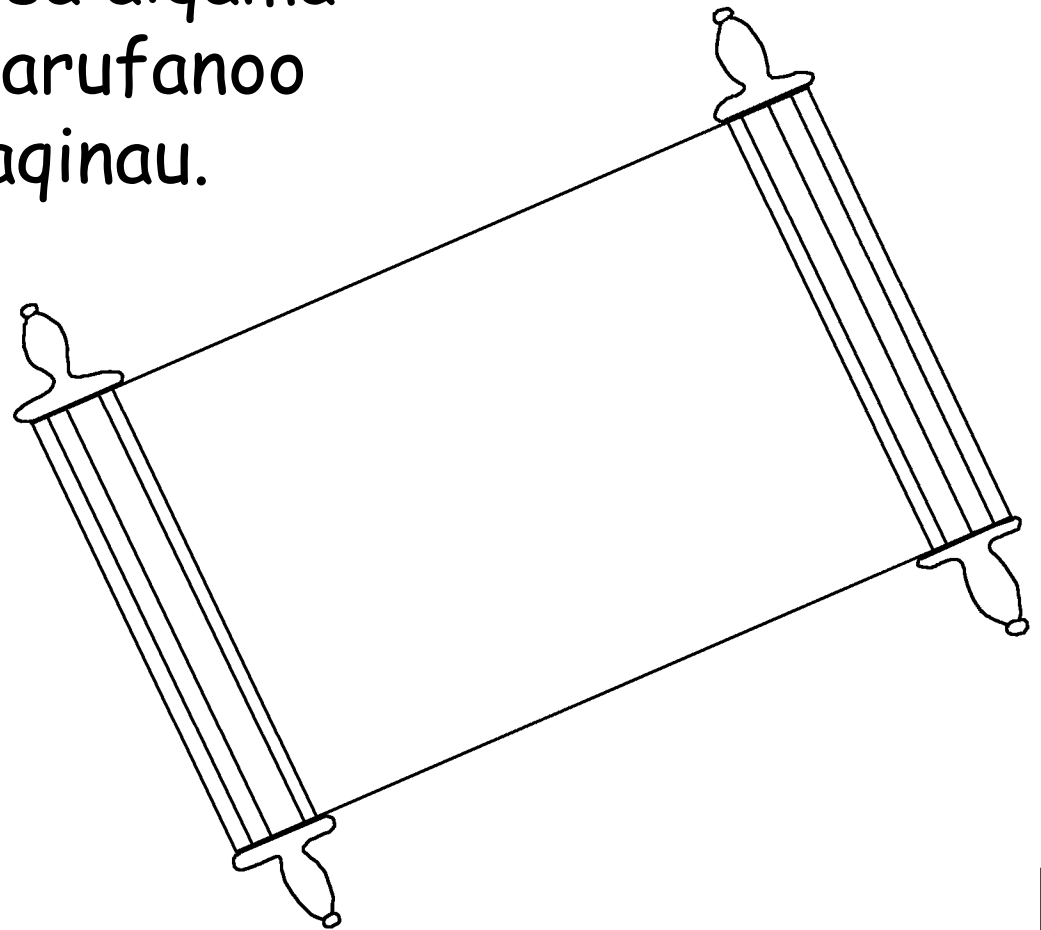

Anutuna maraquna faqa sipsipa aanaaqi Yisuna anaqa  
faqa aiqamausara mai aniaqee qidaqa. Aiqama maa  
ufana irimariasa innee faqa quandafi niqoonausa  
naaraaqa aniaqee qiaqa. Yisufa naaru marira nammari  
nimianee qidanoo. Aiqama nammariara nidimarisa  
doo aniree  
naaqa.

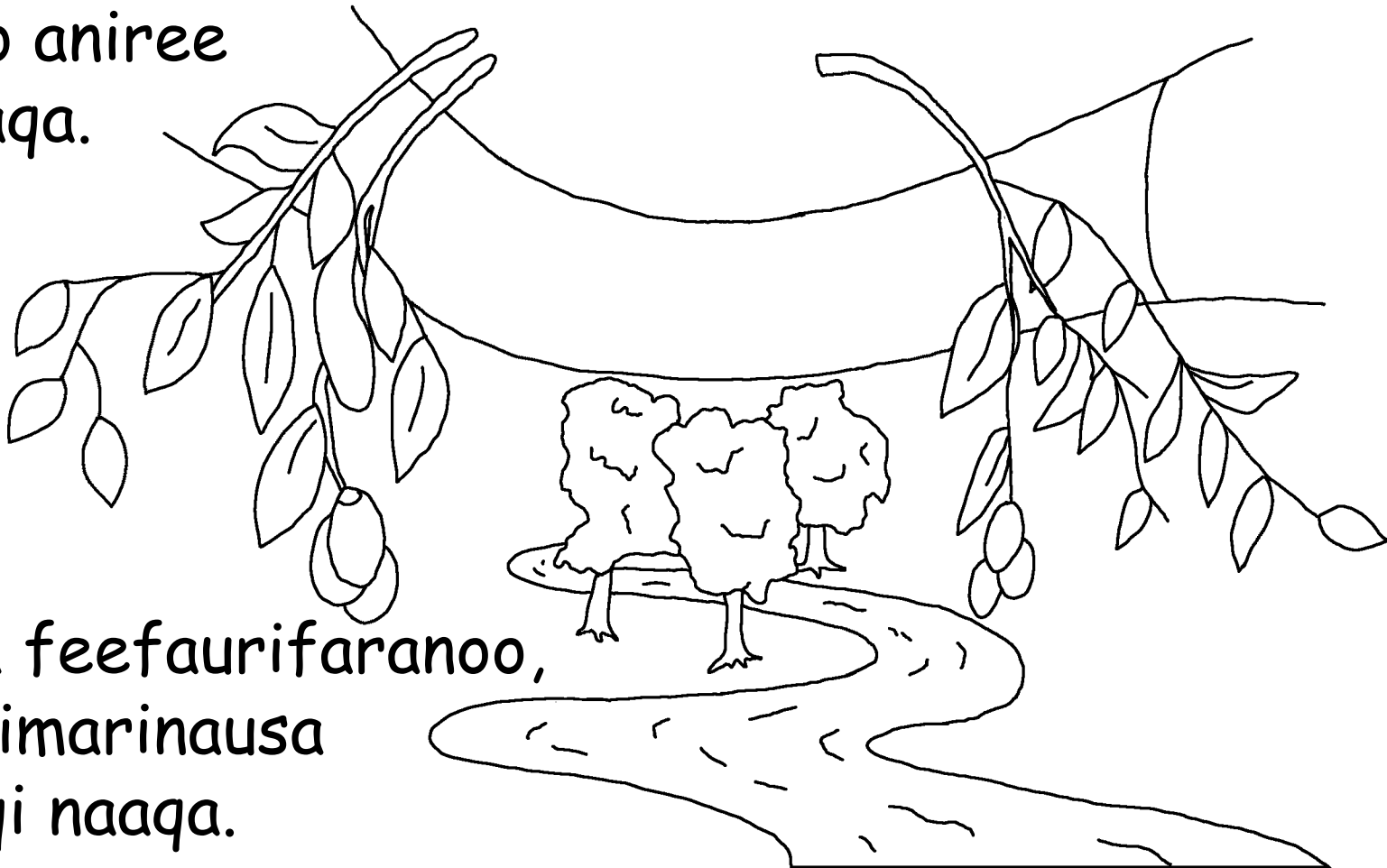

Sia feefaurifaranoo,  
nidimarinausa  
kaqi naaqa.



Anutufa maa  
maqanasaa mariasara amuqusa firaaqoo  
qunara narí amaaku moodaa uqanna  
amiqirana maqasaqaraasa nimuna  
mina saqarikinausa sia kuridiranaki  
fifaranoo Anutuna naaru  
mariranaki fuageera narí  
amaaku nimirau.



Roomma 3:23 Faiqí anaasee narí Anutuna asauku mundirana saqarikiranannai Anutufa mareeqee narí afusaa andeeqaranaki quqaidanoo. Aiqamausa asauku mundirana Yisuna ufa irisee minasaa rusimariasa miqi qimariasa aiqama maqannaasa Anutufa mareeqee narí afusaa andeeqaranaki quqaidanoo sia raina rainiannoo.

Roomma 6:23 Dinni manda oosana fannoo narí ainainimariasa naarama quqaseenoo narí ainainirana akiqara feefauru nimidanoo mi feefaurufa kuqirafa kai maridanoo. Kafaa mina dinni Anutuna kaqi nimira ainaina innaarunai naaru marirafa sia ainainirana akiqara maridanoo, mina asauku mundirafa maasa karaambaiqa Yisufa mina faqa moodaanaki kiqa maridaqa mina namufaqa innaarunai naaru marirana kaqi nimirafa mariannoo.



Heeburu 9:27 Aiqamausa moodaa kari kuquannana amana kai Yisufa moodaa kari kuqinau, aiqamausa moodaa kari kai kuqufiqa miqooqari Anutuna faqa ufa qiranaki fifaranoo.

Eefeesusa 2:8,9 Sia moo ainainannai Anutufa nari afaariranannai kai inni innaarunai asumu mariranaki quqannisaidanoo, innee Yisuna saqarikiranannai afaaramma nimaqaidanoo. Inni asumu nimirafa sia innee andeeqasee fimarianasaafau mundidanoofau, sia innee amiqira oosana marasaida kadaapiridee qimarianasaafau mundidanoofau, Anutuna kaqi nimiranasaa kai innaarunai asumu marirana maasa qimirana uqeereenoo. Sia maasa qeeqa kadaapiriranannai innaaruna asumu maraanaura minara sia fifau maasa qeeqa qimooqira ufa mariannoo.



Roomma 10:9,10 Maaqi qimasee qimannimidaqa, anee aneenna afaurunnai Yisufa kuqaa karaambaiga maridanoo fee qimasee, aneenna amuqusa ookiqari kuqaa Anutufa Yisuna kuqiranakinaana uqeeranau maqi qimasainanoo Anutufa narí asumu mariranaki ani mara quqaannoo. Maasa qeeqa qimuqusannai Anutuna andeeqaranaki fidaqa qeeqa qifaurunnai mina kooroo iranannai Anutuna asumu mariranaki fidaqa.

Yoohanee 3:16,17 Anutufa maa maqanasaa mariasara amuqusa firaaqoo qunara narí amaaku moodaa uqanna amiqirana maqasaqaraasa nimuna mina saqarikinausa sia kuridiranaki fifaranoo Anutuna naaru mariranaki fuageera narí amaaku nimirau. Anutufa sia maa maqanasaaqaraa fasiqa anaasee narí ufa firaanaki mara aquanifeerau narí amaaku maa maqanasaa quqannisanau. Mifa faiqí anaasee nariranakinaana qumbaqeeqee naaru asumu mariranaki quqannisaanifeera Yisuna quqanau.



1 Yoohanee 5:11-13 Anutufa narí amaakuara qu ufafa  
maaqimminoo maridanoo Anutufa naaru naaru kuqaa  
marirana maasa qiminau, mi marirafa maasaindi mina  
amaakuki marifa maridanoo. Yafa yafee Anutuna amaaku  
qumarainafa doo mifa mi marirana namufaqa  
qumareenoo. Yau yausee sia Anutuna amaaku  
qumarainausa sia mi marirana faqa qumaraidaga. Innee  
Anutuna amaakuara irirana rusimariasa innee doo naaru  
marirana doo maree fee qiageera maa ufana akara  
rumannimaqaidaga.



Yoothane 14; 2 Koorinti 5;  
Uqafiqoo Ufafa 4, 21, 22

Storyline by: Edward D. Hughes

Illustrated by: Lazarus  
and Alastair Paterson

Adapted by: Sarah S.

Binumarien Bible (bjr) © 2017 Wycliffe Bible  
Translators, Inc. All rights reserved.

<https://live.bible.is/bible/BJRWBT/MAT/1>

©2026 Bible for Children, Inc.

[www.M1914.org](http://www.M1914.org)

[www.bibleforchildren.org](http://www.bibleforchildren.org)

