

San Juan 14

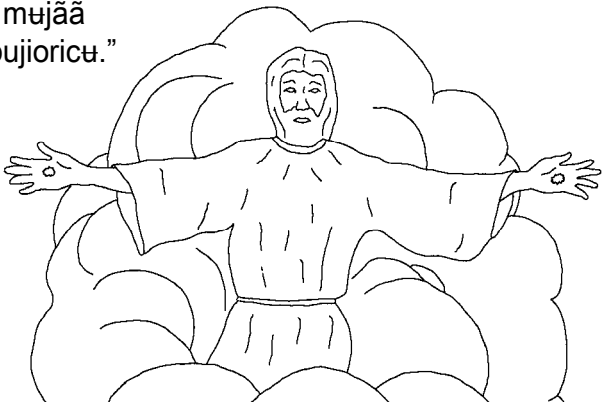

“Yꝑ yarã, tũgoñarĩqũẽ paieticõãña. Dios mena tũgoñatutuari yꝑ mena cũãrẽ tũgoñatutuacõãña. Yꝑ Pacꝑ cũ caãno umꝑrecóorꝑre ãnapauri capee majũ niña. Yꝑ Pacꝑ tꝑrꝑ ãnimasĩrĩqũẽ caãmerĩcõãta, ‘Mujãã caãniparapꝑre mujãã yꝑ qũẽnojũgoyetibojau áya,’ mujãã ñietibujioricꝑ.”



“Bairi mai, yꝑ ꝑame mujãã caãniparapꝑ roto mujãã qũẽnobojaꝑ ácꝑ yꝑ baiya. Bairo qũẽno yaparori bero roque, mujããrẽ yꝑ nei atĩgu, yꝑ mena mujãã caãnimasĩparore bairo ĩ. Bairo yꝑ caató, mujãã cũã yꝑ caãniparapꝑ mujãã ãnigarã.”

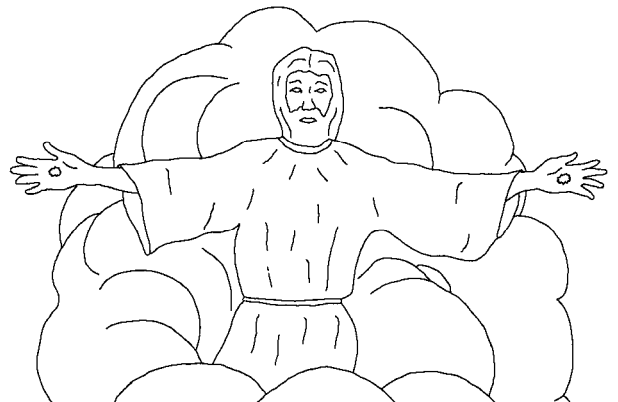

Үч, Juan, мујџаа уау, мујџаарџџа бairo caācū уч
āniña. Bairi уч cūā мујџаарџџа бairo Jesucristo
mena caācū āniñi Dios cū
carotimasĩrapap caānipap

majū уч āniña. Уч cūā
мујџаарџџа бairo Jesucristo



jūgori popiye уч
tāmnonucūña.

3

Bairo popiye tāmnonucūñā, Dios учре
tūgoñatutuarique cū cajoro jūgori popiye уч
catāmnonucūñjēre уч

нчcānetōmasĩcōānucūñā.



4

Dios yaye queti cariapea Jesucristo cūā учре cū
caquetibujnetōñiqūē quetire уч
caquetibujnucūñjē jūgori, Patmos
уччроарч уч cūrocawā, учре

caboena. Bairi ti уччроарч
уч āmч ti watoare уча.



5

Bairo caĩrō, jicoquei Espiritu Santo cū catutuarije jūgori
umrecóopч уч acoápú. Topч etari уча, ñiñaroyawч
umrecóopч carotimasĩ majū ruiricarо tronorē. To
ruiricarore jĩcāñ carui cūārē cū ñiñaroyawч.

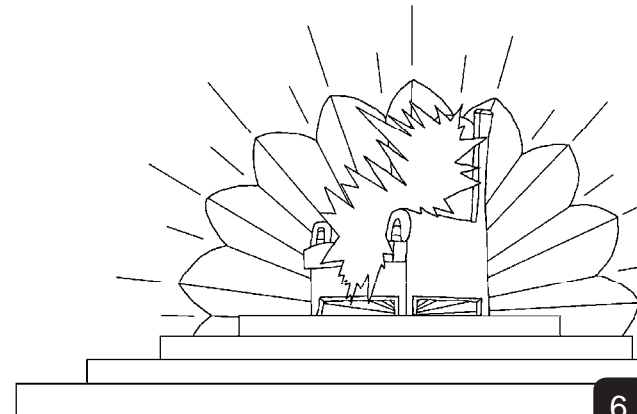

6

Tunu bairoa уч tūgowч nipetiro umrecóo macāñjē
Dios cū caquēnoñiqūē ati yepa macāñjē cūā caĩñjēre.
Ati yepa roca, bairi ria capairiya
cūā bairo caĩbasapeorijere уч
tūgowч: “¡Carotimasĩruiricarо
tronopч carui, bairi
Cordero cūārē
basapeorique
to āmarō!”

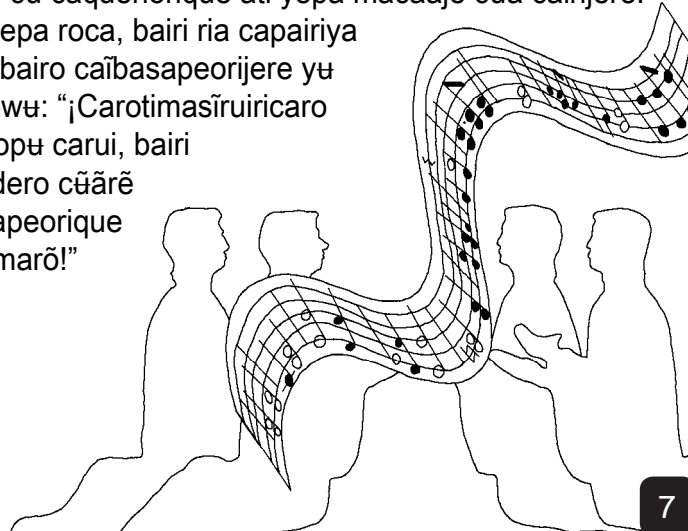

7

“Nocārō cañuч cū cañnoi, cū jetorea ĩroarique to
āmarō. Nocārō cū catutuarije cūā tocānacā rūmчa to
ānicōā ninucūáto. ¡To petieticōāto!”
ĩ basawā capāārā ángelea majā.

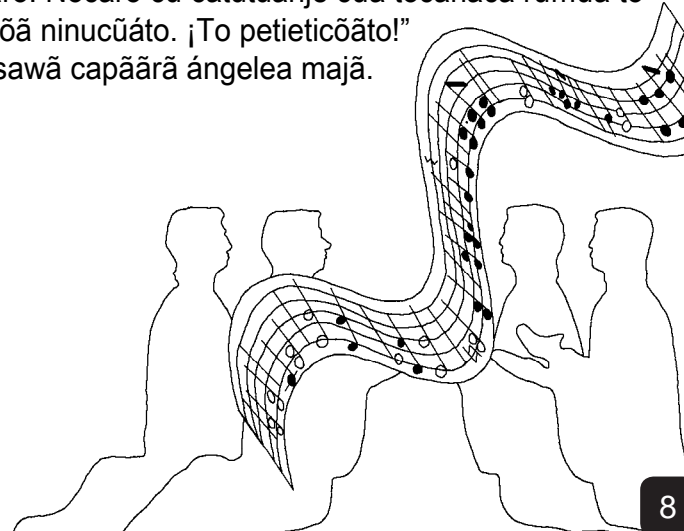

8

Tunu bairoa ñiñaroyawu macã caroa macã majūrē. Ti macã ruame cawāma macã Jerusalén āmu. Dios cū cañajoro umurecōropu caruiatiata macã majū āmu. Caroaro qūēnoyu peyocōāricā macã āmu. Jīcāō carōmio cō manaru cañipare caroa jutii jāñarī cō cacoterore bairo caroa macã majū āmu.

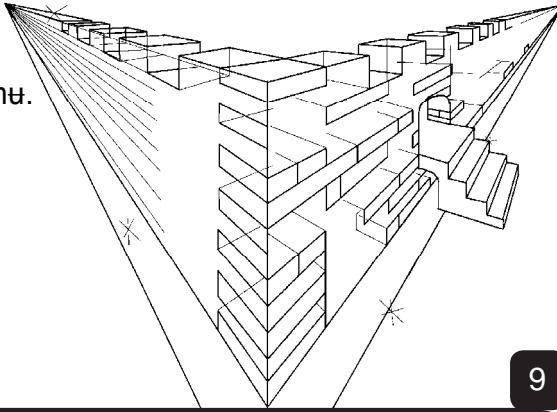

9

Tocārōā yu tūgowu tutuaro busurique quetiupau cū caruiro tronopu caatiere. Atore bairo iñoroyawu busurique: “Āmerē Dios camasā mena niñami. Na mena tocānacā rūmna nicōā ninucūgumi. Na, camasā, cū yarā cū ya poa macāna nigarāma. Cū, Dios, cū majūā na Quetiupau Dios nigumi.”

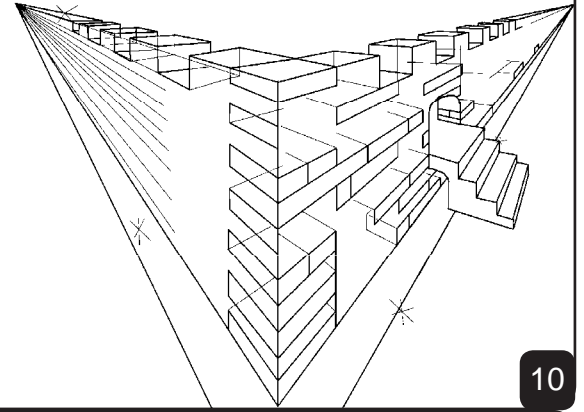

10

Bairo tiere yu cañapetiro bero yua, jīcāū āngel ñiñowī ria caugueri maniya majūrē. Tiya oco ruame catiānajē majūrē cajoriya āmu. Ēñoorōrē bairo caroaro majū iña āmewiyoricya caroa oco tusuriya āmu. Bairi tiya, Quetiupau Dios bairi Cordero mena na caruiro trono rocare niwitiwu.

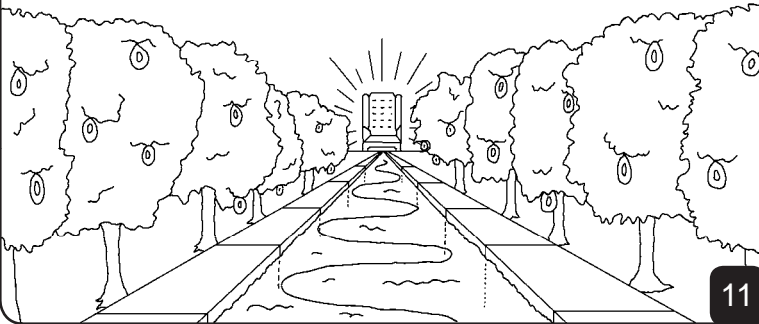

11

Bairi tunu ti macã ñe ūnie rusaepu. Muipru umureco macācū, o ñami macācū ūcū cūā ti macārē cū cajñabusuwopee mamu. Merē Dios cū caasiyabatorije mena jūgori ti macã caroaro jīcārō tūni busuwopeticōāwū. Tunu bairoa cū macū Cordero cūā jīñaworicare bairo caācū ti macārē cajñawonemou majū āmi.

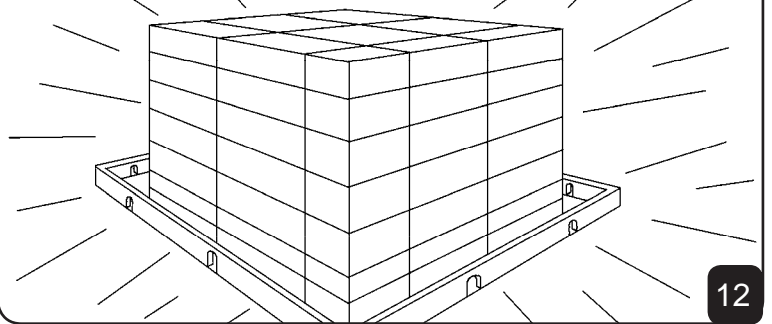

12

Dise ūnie carorije macāājē roque peeto ūno ti macāpūre jāāmasiētīguro. Tunu bairoa ni ūcū āmerē Dios cū cateerije ūnierē caācu cūā jāāmasiētīgumi. Caītopai, iñoriquere caātipai cūā jāāmasiētīgumi. Dios yarā caāna cacatiāniparā wāmerē woaturica tutipru cawoatuecoricarā jeto ti macārē jāāmasigarāma. Ti tuti Cordero ya tutipru cawoatuecoricarā jeto jāāmasigarāma yua ti macārē.



13

“Cū, Dios ruame nipetiro na caapee ocore paaregumi. Bairi yua, narē di rūmru riarique manigaro. Bopacooro bairique, otirique cūā manigaro. Roro pūnirō tūgoñarīqūē ūnie cūā manigaro yua. Cajūgoyepu nipetiro wāme roro bairique caānimiriqūē peticoapu. Bairi roro tāmuorīqūē manigaro yua,” ī ocajowu busurique.



14

Bairi tunu ti macãpũre carorije áticũřicãrõrẽ bairo caãnie manigaro. Ti macãpũ Dios, bairi cũ macũ Cordero mena na caruiro cũã topũa nigaro. Bairi cũ yarã cũ canetõřicãrã cũtũ macããnarẽ bairo caãna jeto qũĩroagarãma. Na pũame cariapea Diore qũĩĩnamajũcõãgarãma. Tunu bairoa na riape buire tocãnacãřũa Dios ya wãmerẽ na riapoarũ woaturicãrã nigarãma.



15

Bairo cabairo yua, tocãrõã ñĩnaroyawũ cariaricãrã ãnanarẽ. Quetiuparã rotiri majã caãnimajũrã, aperã paacoteri majã ũmũarẽ bairo caãna cũãrẽ na ñĩnaroyawũ. Quetiuparũ cũ caruiro trono riapere nucũwã. Bairo na canucũrõ papera tutiirire pããwĩ Quetiuparũ pũame yua. Ape tuti cacaticõãniparã Dios yarã na caãno cãrõ na wãmerĩrẽ cũ cawoaturica tuti cũãrẽ pããwĩ. Bairo ti tutiirire pããřĩ bero yua, ti tutiiripũ na caátaje woaturique nipetirijere ñĩnacõãrã na ñĩabesewĩ.

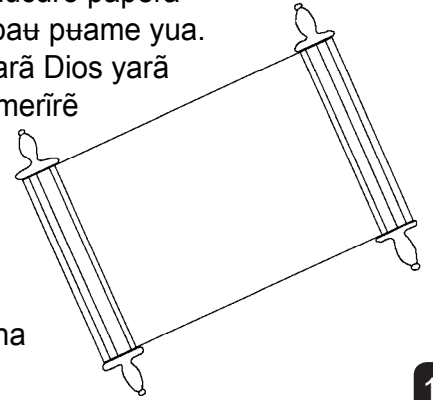

16

Dope bairo caroaro na caátajere, o roro na caátaje cũãrẽ ĵicãrõ tũnia na ñĩabesewĩ nipetiro cariaricãrã ãnanarẽ yua. To azufre mena caũřĩrapũ cacatiãniparã wãmerẽ woaturica tutipũ cawãmetusaena pũamerẽ na reũajocõãwĩ Dios. Topũ tocãnacã řũmũa popiye bopacooro tãmũocõã ninucũgarãma.

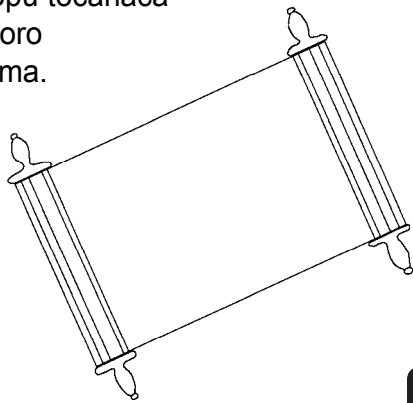

17

Bairo cũ caĩrõ bero, Espĩritu Santo, bairi Corderore catũgousarã Dios yarã cũã bairo ĵwã: “ĵTãmurĩ tiaya jãã tũpũ!” ĵwã. Bairi aperã noa ũna atie cũ caĩřĩjẽrẽ cariape catũgorã, “ĵTãmurĩ tiaya jãã tũpũ!” qũĩĩna mujãã cũã.



18

Ñeme ĵipiricarore bairo noa ũna butiuro Diore caborãrẽ caroa caticõãnajẽ majũrẽ na jogũmi. Na carorije wapare na netõõgũmi. Peeto ũno wapa ĵẽniřicãrõ mano na jogũmi catirique majũrẽ.



19

Dios pũame ati ũmũrecóo macããna nipetiro camasãrẽ butiuro maiĩami. Bairo marĩrẽ mairĩ, cũ macũ ĵicãũã cũ caãnimiatacũãrẽ, cũ joyupi ati yerapũre, nipetirã cũ macũrẽ catũgousarã na yasieticõãto ĵ. Cũ mena caroaro ãnicõã ninucũgarãma tocãnacã řũmũa.

60

60 20

Romanos 3:23 Bairi marĩã camasã nipetiro roro caána jeto marĩ ãniña. Ni jĩcãũ ũcũ Dios cũ caborore bairo caátietapeti mácũmi.

Romanos 6:23 Bairi roro camasã caátipairã na yaye wapa peeropu caápárã niñama. Dios marĩrẽ cũ cajorije pũame roque yeri capetietie niña. Jesucristo marĩ quetiupau jũgori wapa jẽniĩcãrõ mano tiere marĩ joyami.

Hebreos 9:27 Bairi marĩ camasã cũã jĩcãnia marĩ riagarã. Marĩ cabaiyasiro bero, Dios nipetiro marĩ caátajere marĩ ãĩabesegumi.

Efesios 2:8,9 Bairi marĩrẽ cũ camairĩjẽ jũgori marĩ netõõñupĩ, cũ mena catũgoñatutuarã marĩ caãnoi. Marĩ majũã caroa wãmerẽ marĩ caátie jũgori mee, Dios marĩrẽ maiĩrĩ jĩcã nũgõã cũ caátigarije jũgori roque marĩ netõõñupĩ. Bairi ni jĩcãũ ũcũ, “Yũ majũã caroare átiri yũ netõwũ,” caĩmasĩ maami.

21

Romanos 10:9,10 Tie quetibujuri que atore bairo ĩ quetibujuya cariape marĩ cabũsurije mena: “Jesús marĩ Quetiupau niñami,” ĩĩĩ bero tunu, “Jesús cũ cariaacoamiatacũãrẽ tunu cũ catioyupi Dios,” marĩ yeripu marĩ caĩũgoñãata, Dios pũame roro marĩ caátaje wapare marĩ netõõgumi. Bairi marĩ yeripu Jesucristo mena tũgoñatutuari, tunu cũ yarã marĩ caãnierẽ aperãrẽ na marĩ caquetibujyata, Dios pũame, “Caroarã, ñe ũnie carorije cawapa cũgoena niñama,” marĩ ĩ ĩĩagumi. Bairo marĩ caápata, marĩ netõjĩãtigarã roro marĩ caátaje wapare.

22

San Juan 3:16,17 Dios pũame ati ẽmũrecõo macããna nipetiro camasãrẽ butiro maiñami. Bairo marĩrẽ maiĩrĩ, cũ macũ jĩcãũã cũ caãnimiatãcũãrẽ, cũ joyupi ati yeparure, nipetirã cũ macũrẽ catũgousarã na yasieticõãto ĩ. Cũ mena caroaro ãnicõã ninucũgarãma tocãnacã rũmũa.

Dios ati ẽmũrecõo macããna nipetiro cabuicũna na ãmarõ ĩ mee, cũ joyupi cũ macũrẽ. Narẽ cũ netõbojato ĩ roque, cũ joyupi Dios ati yeparure.

1 Juan 5:11-13 Tunu bairoa, atore bairo marĩ camasĩrõrẽ boyami Dios: Yeri capetietie marĩ cacũgopeere marĩ camasĩrõrẽ boyami. Cũ macũ jũgori tie cũ cajopeere marĩ camasĩrõ boyami. Bairi ni jĩcãũ ũcũ Jesucristo Dios macũ yau majũ cũ caãmata, merẽ yeri capetietiere cacũgou tuayami. Apei, Dios macũ Jesucristo yau mee caãcũ pũame roque, yeri capetietiere cacũgoecu majũ tuayami. Mujãã, Dios macũ Jesucristore catũgousari majãrẽ yũ quetibuju woatujoya, merẽ yeri capetietie mujãã cacũgorijere mujãã camasĩparore bairo ĩ.

23

San Juan 14; 2 Corintios 5; Apocalipsis 4, 21, 22

Storyline by: Edward D. Hughes

Illustrated by: Lazarus
and Alastair Paterson

Adapted by: Sarah S.

Carapana Bible (cbc) © 2009 Wycliffe Bible
Translators, Inc. All rights reserved.

<https://live.bible.is/bible/CBCWBT/MAT/1>

©2026 Bible for Children, Inc.
www.M1914.org www.bibleforchildren.org

24