

www.BibleForChildren.org

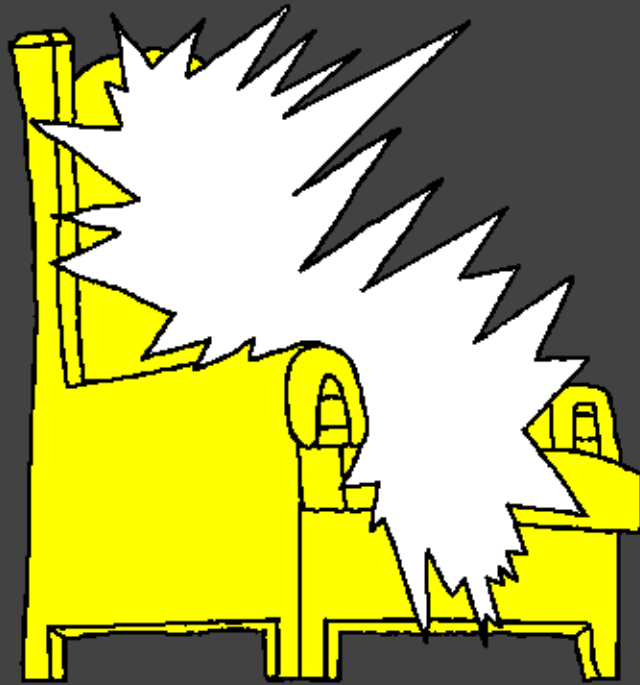

Juan 14



Jesúsra ecuana bahuityanucacuare: —Inime tsape nejuume. Peya inime nejuume. Yusu queja nimee micuana amena juhua. Eaqueja nimee nejuuedya. Ecue Etata aniyajutu aniya dyaque umada ani ishucuanaque. Yunerique ama juatsu taa micuana cuejaquena ama juquena juhua.

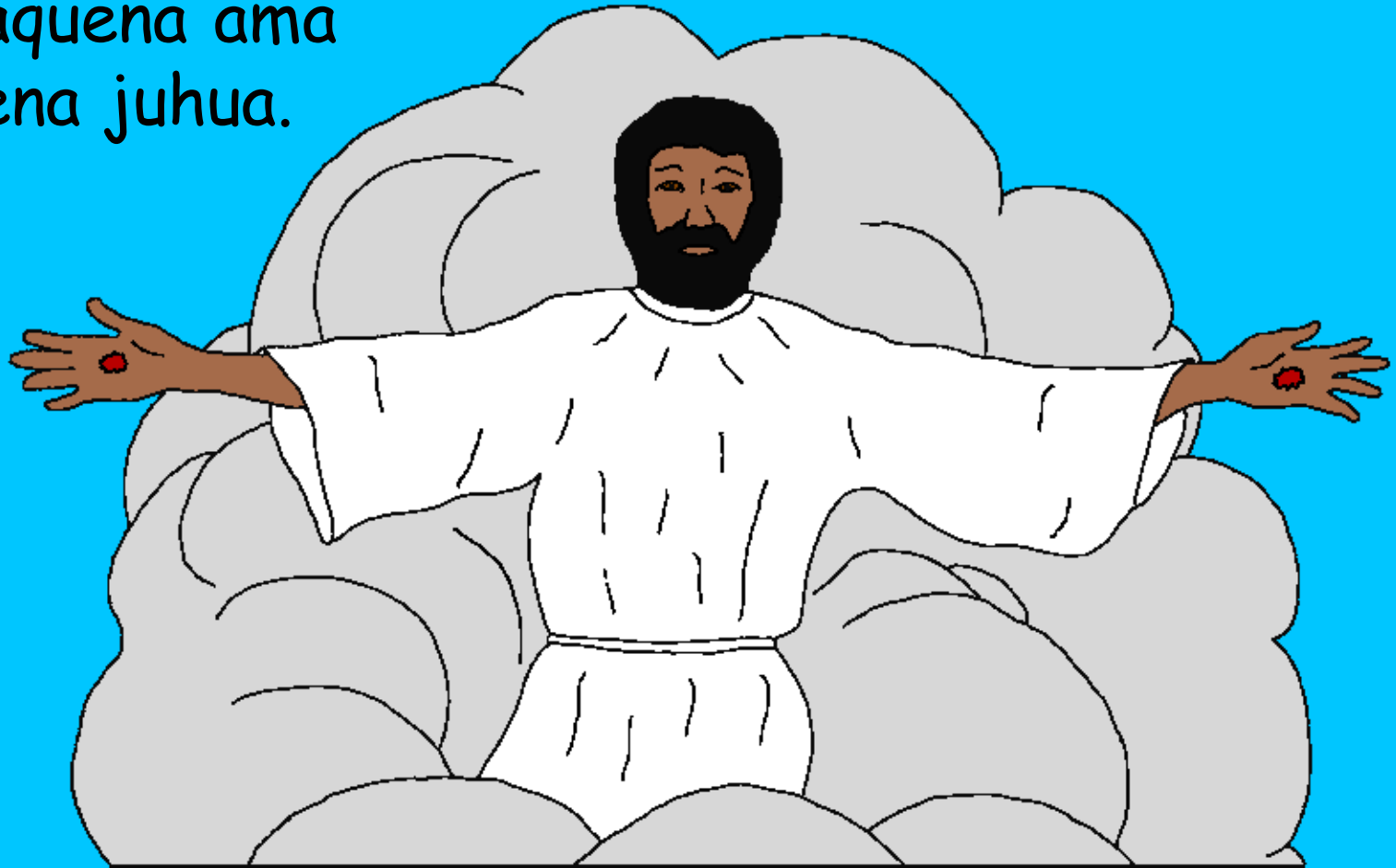

Ique diruya tuhua micuanaja ani ishuque bajejediru
ishu. Dirutsu, micuanaja ani ishuque pabajejediru;
amena aatsu, yudijiya junanucabuque micuana jiteque,
micuana eatsehue diru ishu. Tuhua micuana
aniqueredirubuque ique jakanuca ishu ama.

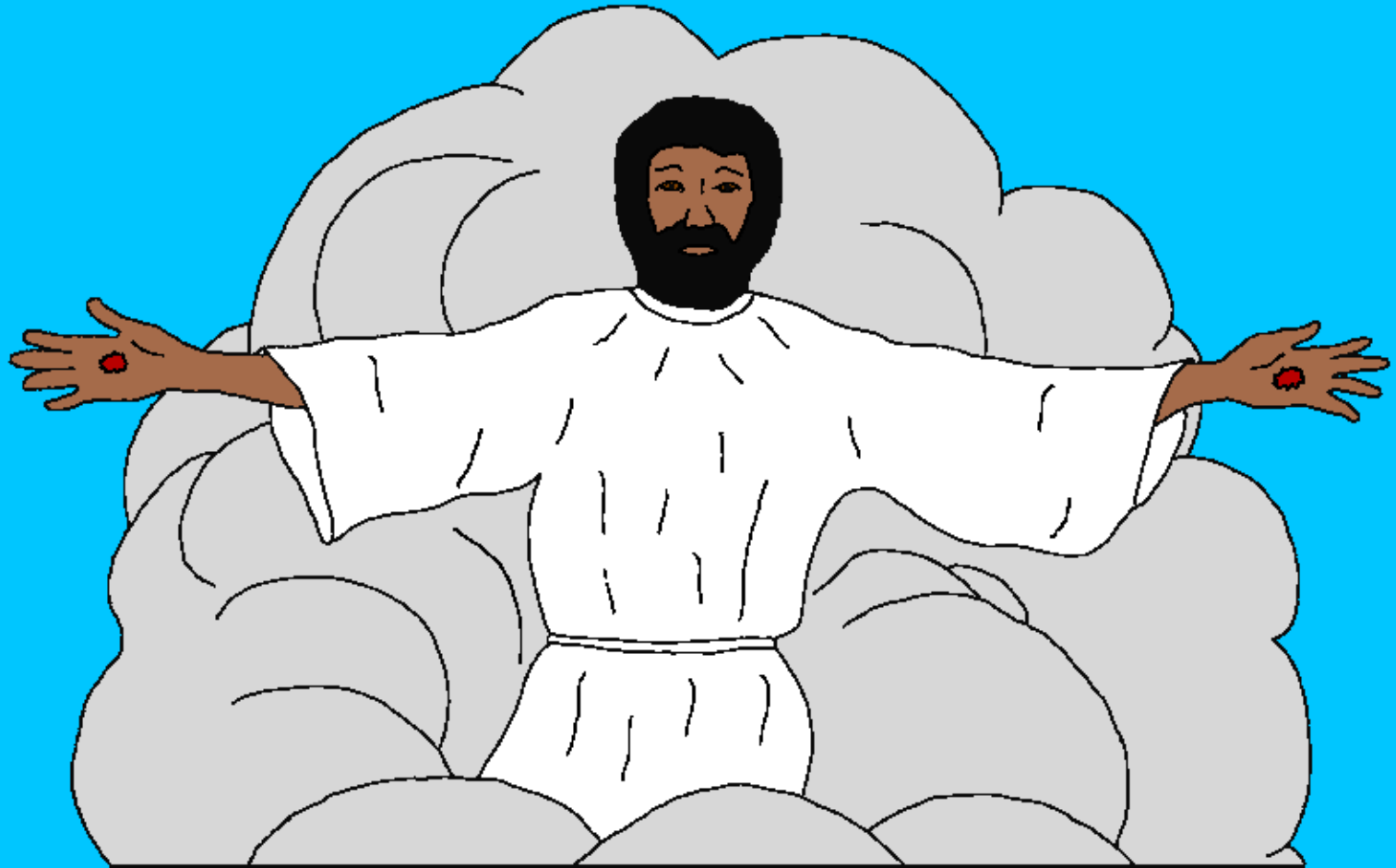

Ique Juan; micuana tsehuequique ique. Yusu tu
ique metseque, tumebaedya micuana metseque.
Jesústu ecuana jiteque nerecada juhua.

Tumebaedya micuana ique
jadya ecuana nerecada



juhua tuaqueja
nimee juatsu.



Dutya rique ecuana iduya abacada tsehue
tuaqueja catyatijacatsu ama. Huaraji
cuanara ique ijehuecuare ecububu

Patmos bacaniju ique
nerecatura ishu,



era Yusuja quisarati
tsapeya baatsu,
yunerique Jesúsja
ecuejaque.



Tura ique isaraya tsunumee Yusuja Espiritura
bamerehua eje bucha judadiyaque. Bacuare tuque
Huaraji Dutya Casa Tsehueque. Bacuare tuque tuja
eaniquiju aniyaju.

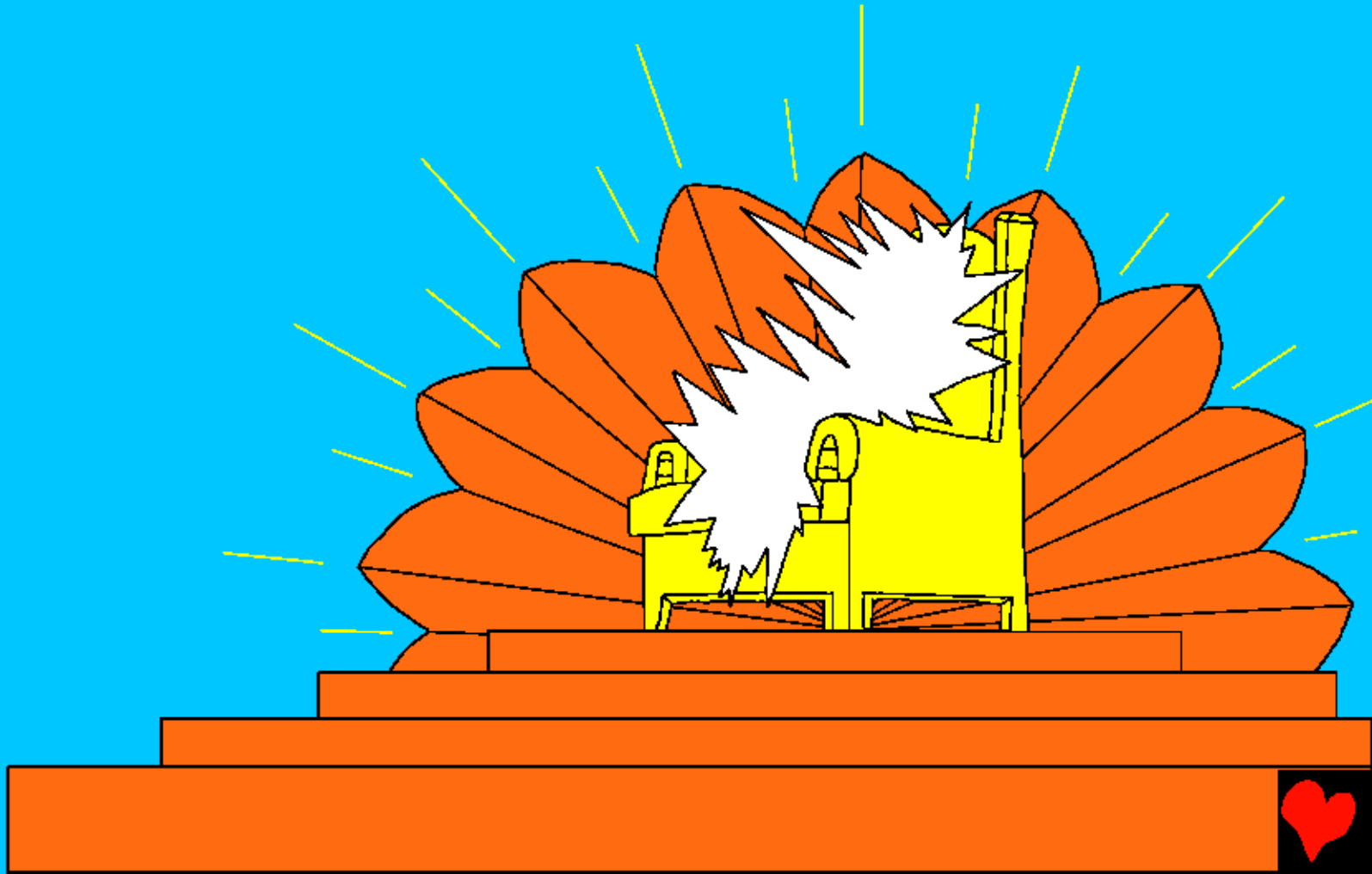

Tumebaedyá tuque bacanucacuare Yusura dutya
iyacuare cuanaque, barepaju cuanaque, yahua
emaque cuanaque, riyaque yahuaaju
aniya cuanaque, cueri cuanaja
ecuaqueju aniya cuanaque,
dutya anicuare cuanaque jadya
juyaju: "Pureama metse
ecuanara aya.
Muiya metse
ecuanara."



"Dyaque jida, casada jadya taa metse. Metsejatu
dutyai ai ataqui. Jadya metse ecuanara pureama
aya, Dutya Cuatsashaquique,
tumbaedy a Jesucristo
UHUISHA BUCHA IYETA
ATAHUAQUE", jadya tunajatu
acuare.



Bacuare tuque epu ebari Yusura cuita iyuhuedaque tura naruyaque, "Jerusalén Iyacuaque" bacani. Yusu aniya equeque tuque buteyaju bacuare epu ebari barepa juque. Dyaque jida piji tuque bacuare. Epuna ahuequi juyaque ecabajejeti aniya bucha tuque bacuare.

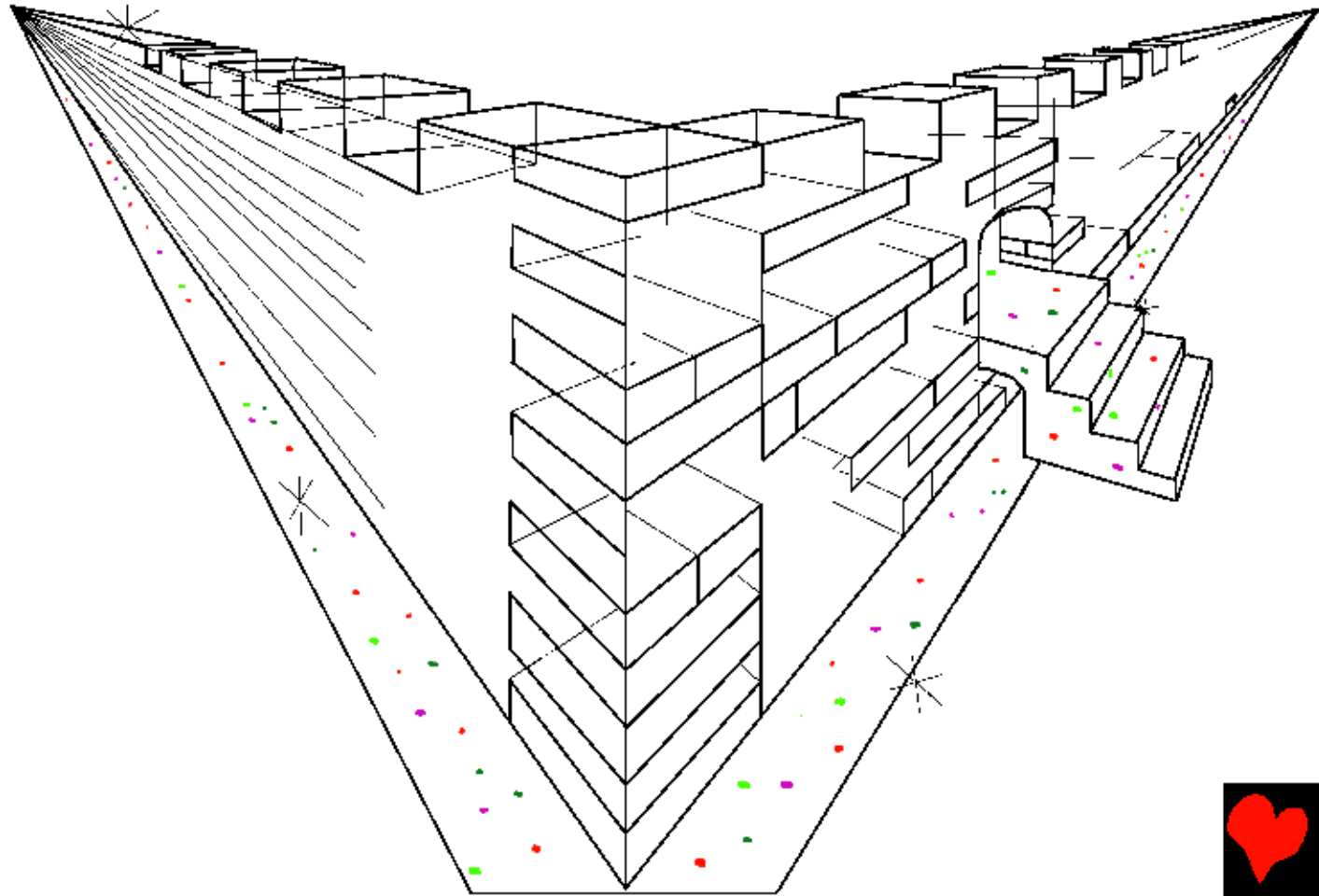

Tume tuque bacacuare etsuri jebudaque Yusu aniya
equeque. —Neijacabacacue. Iyacuatu Yusu aniya
ecuita cuana ducu. Tuna tsehuetu anibuque. Tunadya
tuna tuja cuanaque jubuque. Yusu cuitadyatu tuna
tsehue anibuque, tunaja mui ishu.

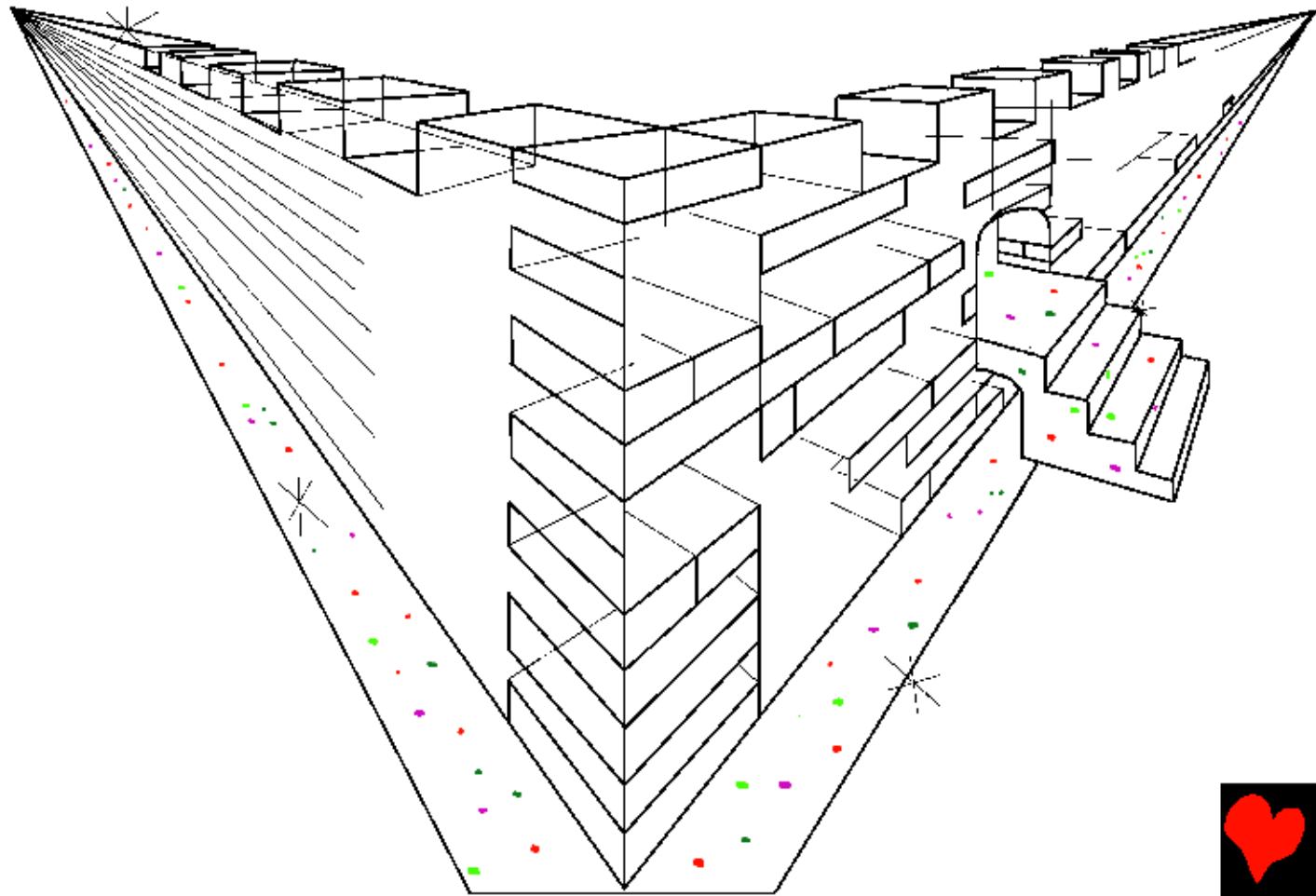

Tuequedya tura bamerecuare cueri jida huecadaque.
Tumeque ena ijitsutu maju baecua ishunque. Tumeque
cueritu cristal bucha huecae jucuaré. Cuinanacuaretu
Yusuja, UHUISHA BUCHA IYETAÉ ATAHUAja
eaniqui cacuatsashati ishú equeque.

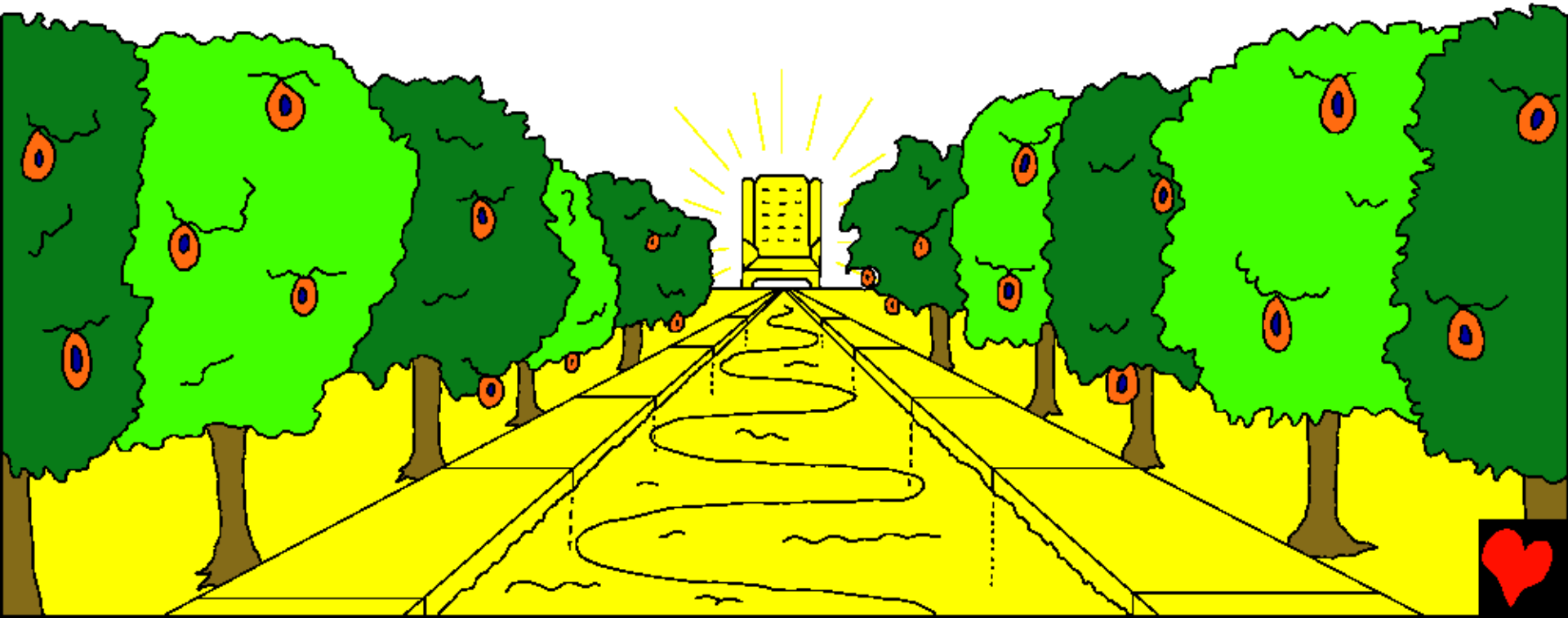

Tuhatu saretanaya ama ijeti ni badi epu uda ishu,
Yusuja huecaradya jutidya epu udaya tibu.
UHUISHA BUCHA IYETAE ATAHUAQUE tu
eudaquique.

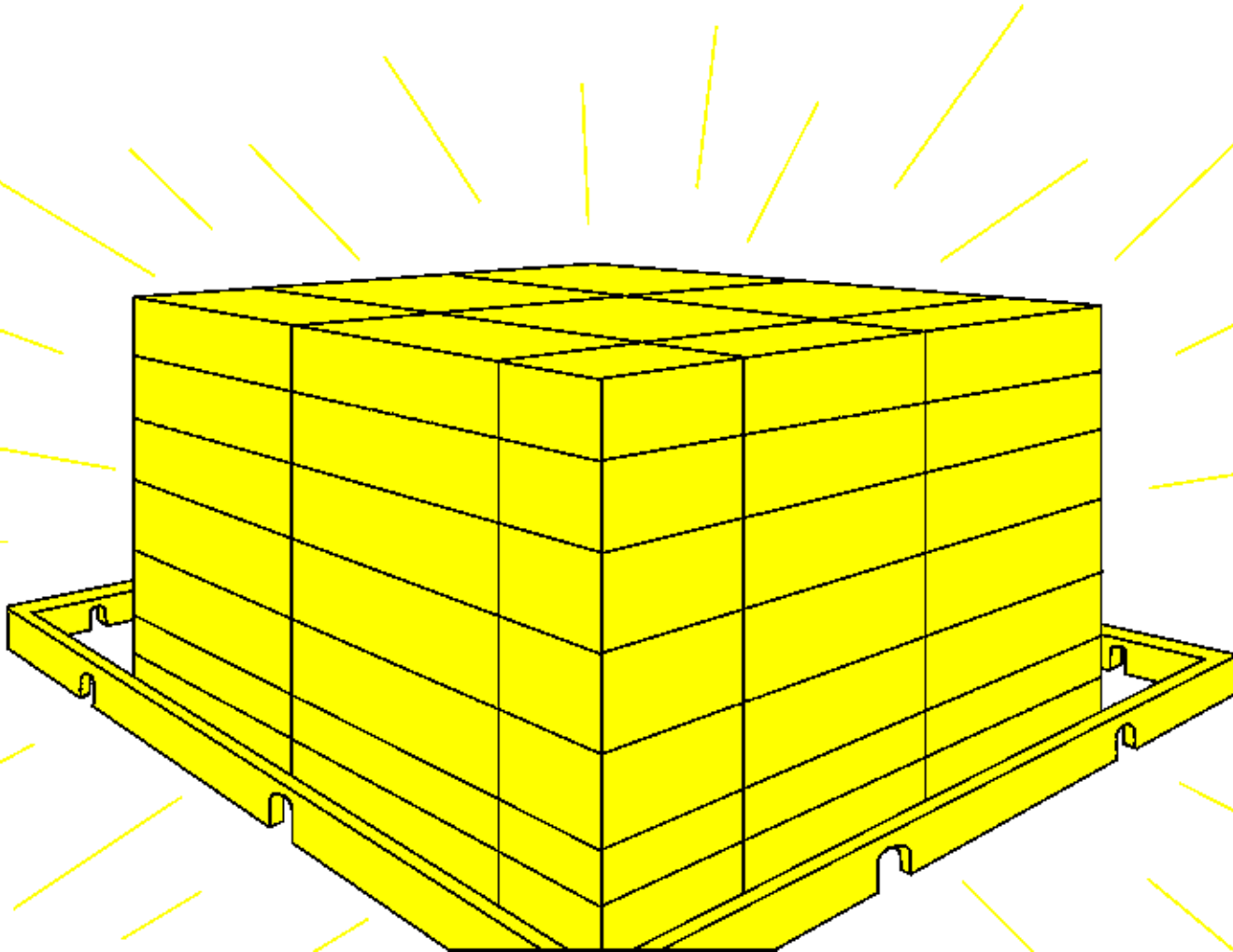

Nubibuque amatu tuhua, ni ai
quibetimaque, cabajejetimaque.
Nubibuque amatu ni ejeque
Yusuja biji eque ama
aniya cuanaque, ni
ejeque jidamaque
ni pusha pusha
aridaque.

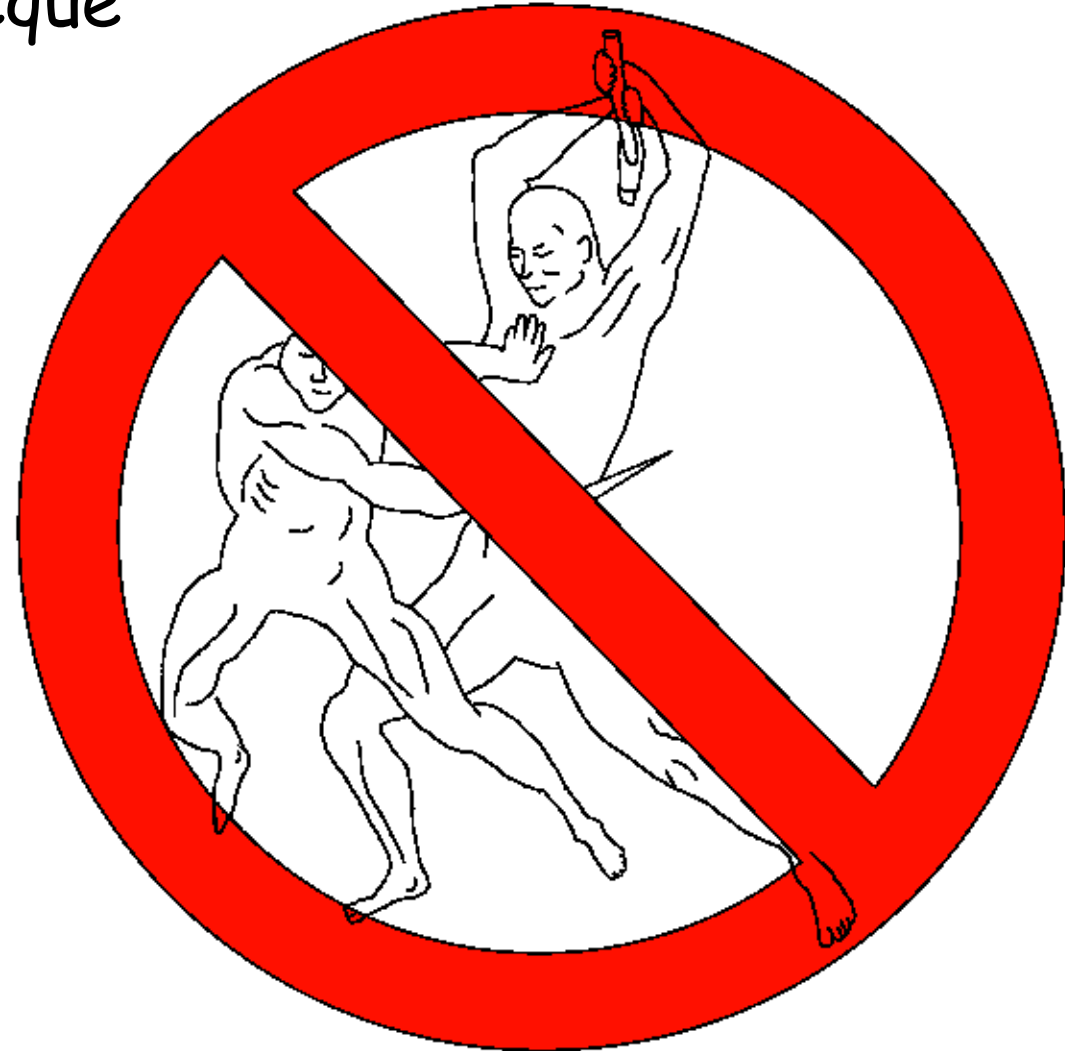

Yusuja quiricaju ebacani ehue
aniya cuanaque cuita camadya
tuna nubibuque, dutya
ebacani eiya cuanaque
Yusu queja judiru ishu
ni eje tupu jaca ishu
ama. Tumeque quirica
tu UHUISHA
BUCHA IYETA
ATAHUAjaque.
Tume cuanaque cuita
camadya tuna Yusuja
epu ebariju
nubidirubuque.



Yusuratu tuja cuanaja
paanacaca tillabuque.
Majunucanime ama tuna; ni
ejequetu panucanime ama. Ni
aijatu ai ujeda junucabuque
ama, beru dutya ai eje bucha
juhuaque cuetihua tibu,
—jadyatu jucuaré.



Tuhuatu amena aijama jidamaque. Yusu, UHUISHA
BUCHA IYETAE ATAHUAQUE jadya tatse huaraji
dyaque muidaque tumeque epu ebari juque. Tatse
merequi cuanara tatse pureama abuque.

Babuque tunajatu
Yusuja ebutsequini.

Equetiju tunajatu
ehuene jubuque
Yusuja ebacani.

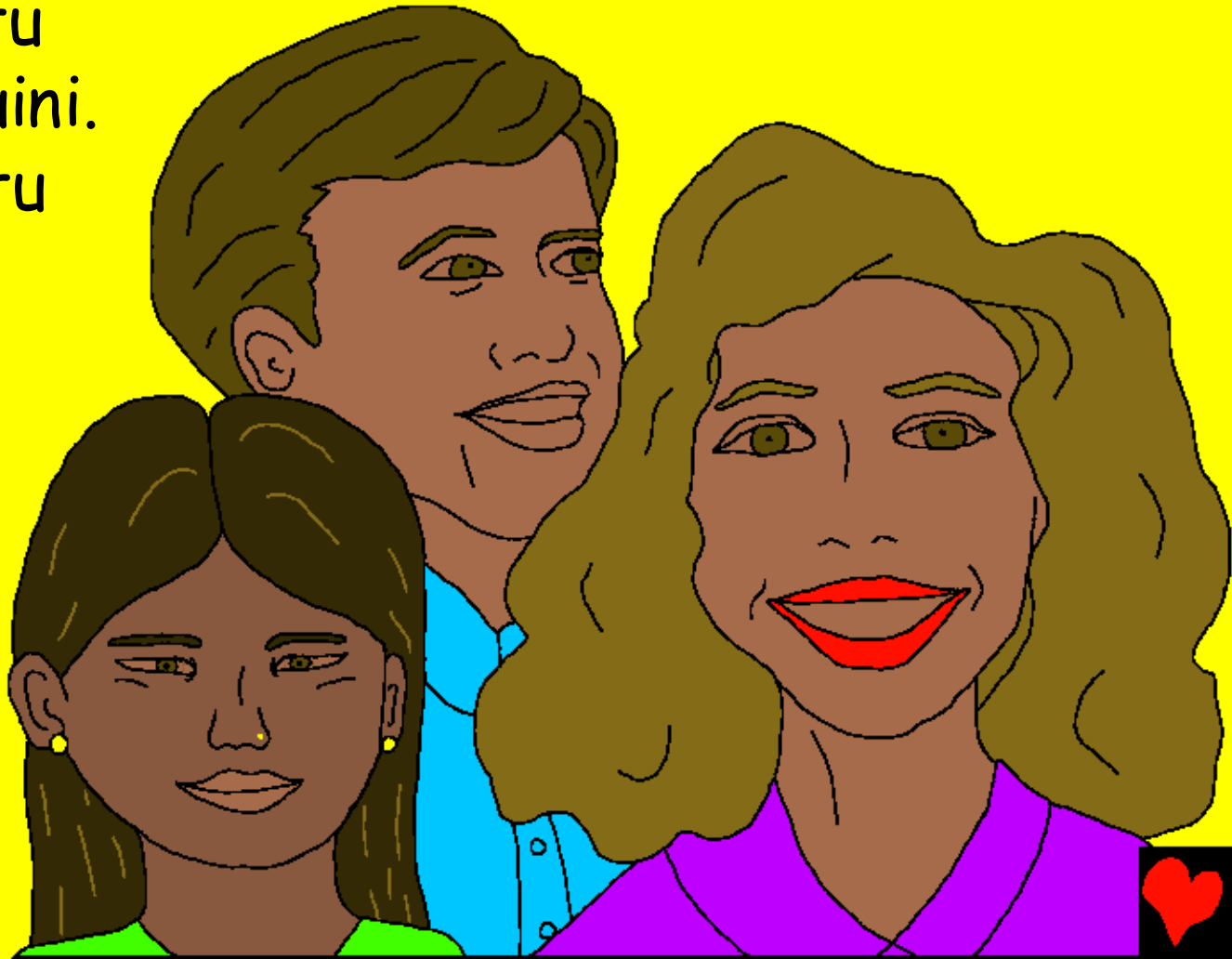

Tume tuque banucacuare emaju cuanaque umada
—nanada cuanaque, ehue ebari cuana, esiri cuanaque
jadya. Tuna tuna neticuare Yusuja yacuaju. Riyaque
yahuaju tuna ai mere juya cuanaquetu ehue
tumeque quiricaju. Tumeque quirica
ecatsetu pacashatanacuare.

Tumebaedyatu
pacashatanacuare
quirica Yusuja
cuanaja dutya
ebacani cuana
ehue cuanaque ni
eje tupu Yusu jaca
ishu cuanaque ama.

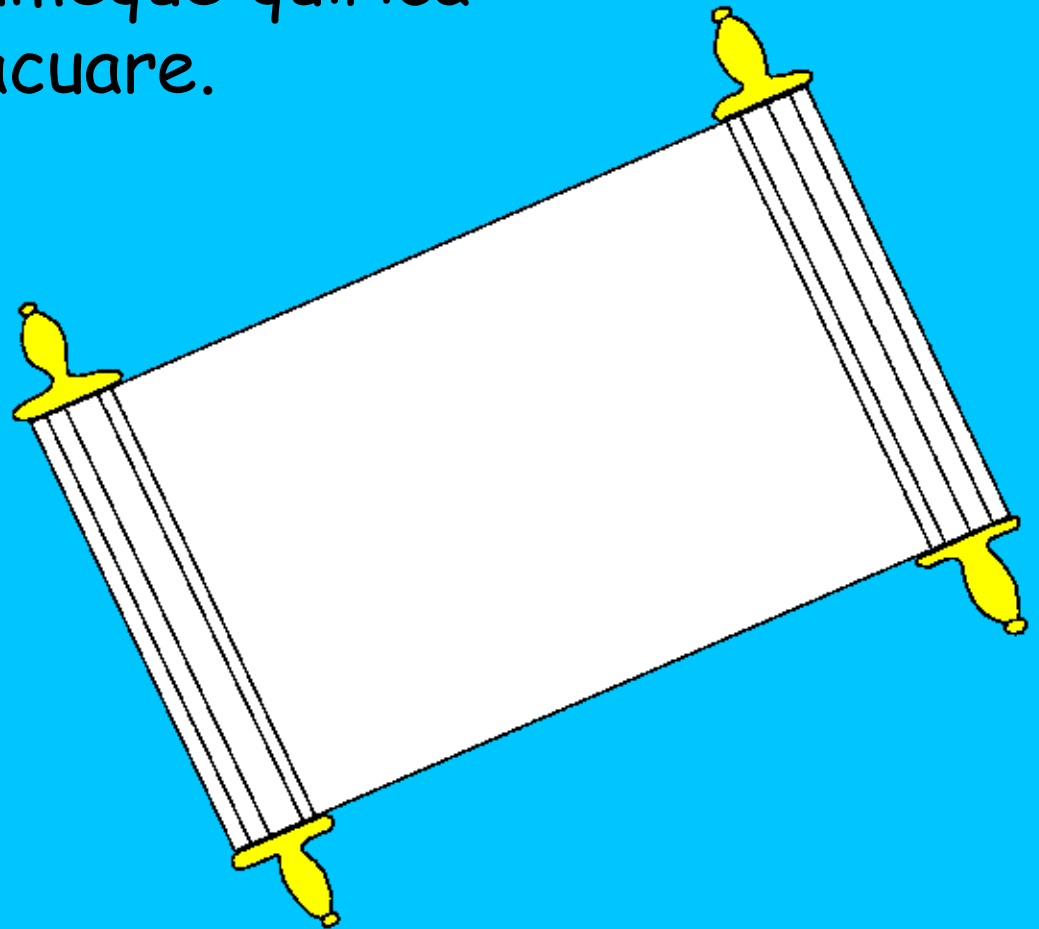

Yusura tuna peadya peadya eje bucha adadiyaque
cuejacuare, tunaja mere eje bucha juhua eque,
quiricaju ehuene equedya. Tuja biji eque anihua
cuanaque tujatu jida acuare. Tuja biji
eque ama anihua cuanaque
patu nerecaturacuare.

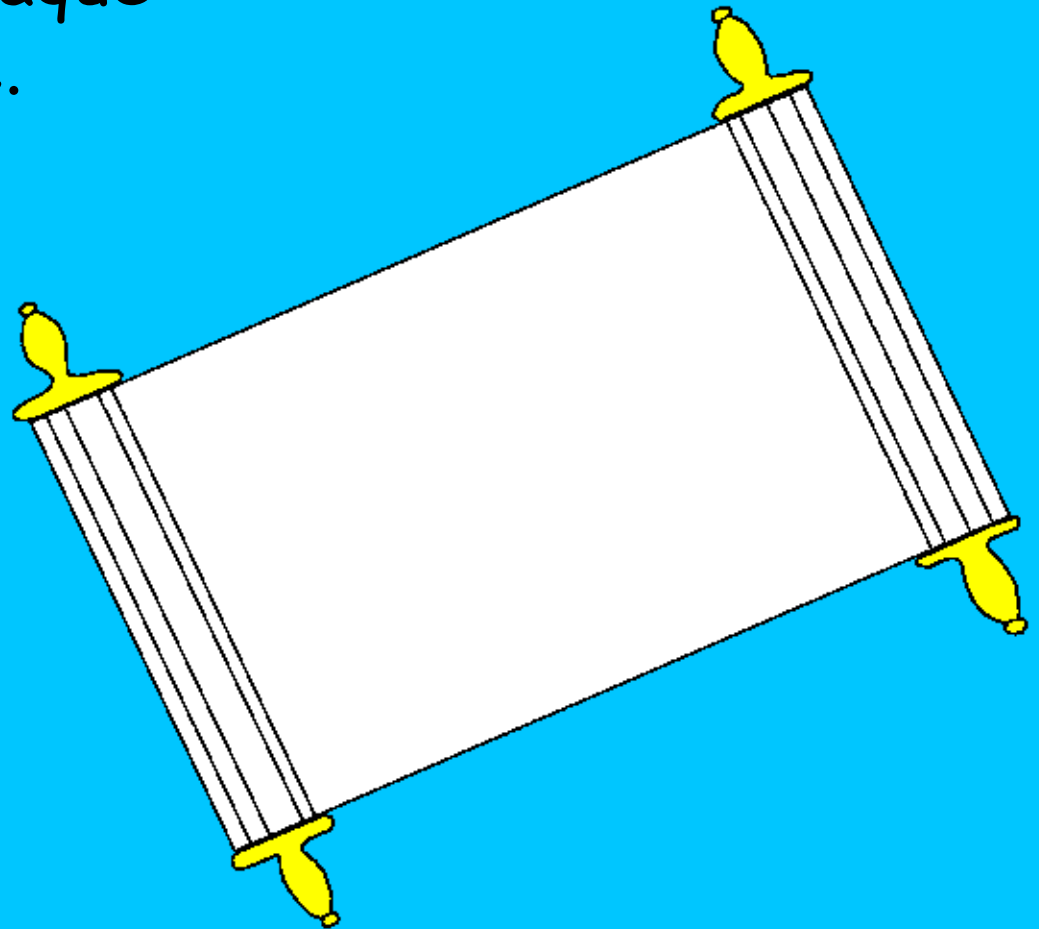

Jadya juatsutu dutya emaju cuanaque, emaju
cuanaque aniquique emajacaju cuanaque, ebacani
Yusuja quiricaju cahuenemeretima cuanaque tuna
ijehuetanacuare etiqui bei tupu arieju. Tuhuadya
tuna nudyatanabuque ni eje tupu cuinana
ishu ama. Riyaque canerecati tere
ishuque ama tu maju beta
ishuque bacani.

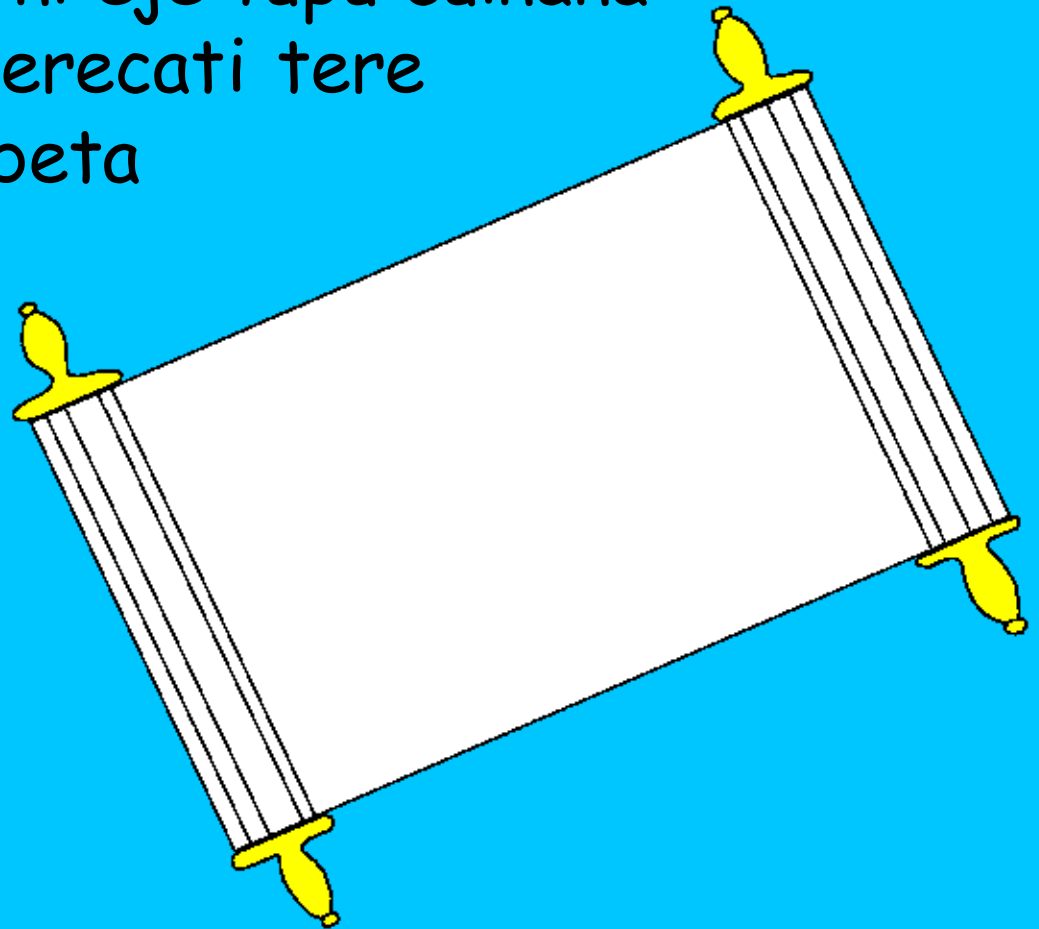

Yusuja Espiritura, tumebaedya UHUISHA BUCHA
IYETAE ATAHUAja ehuanegue bucha cuanaratu
Jesús jadya aya: —Jecue. Ejera pana ijacabaca
ayara neacue Jesús: —Jecue. Ejeque Yusu queja
judirucara juyaque tuaqueja pajudiru.

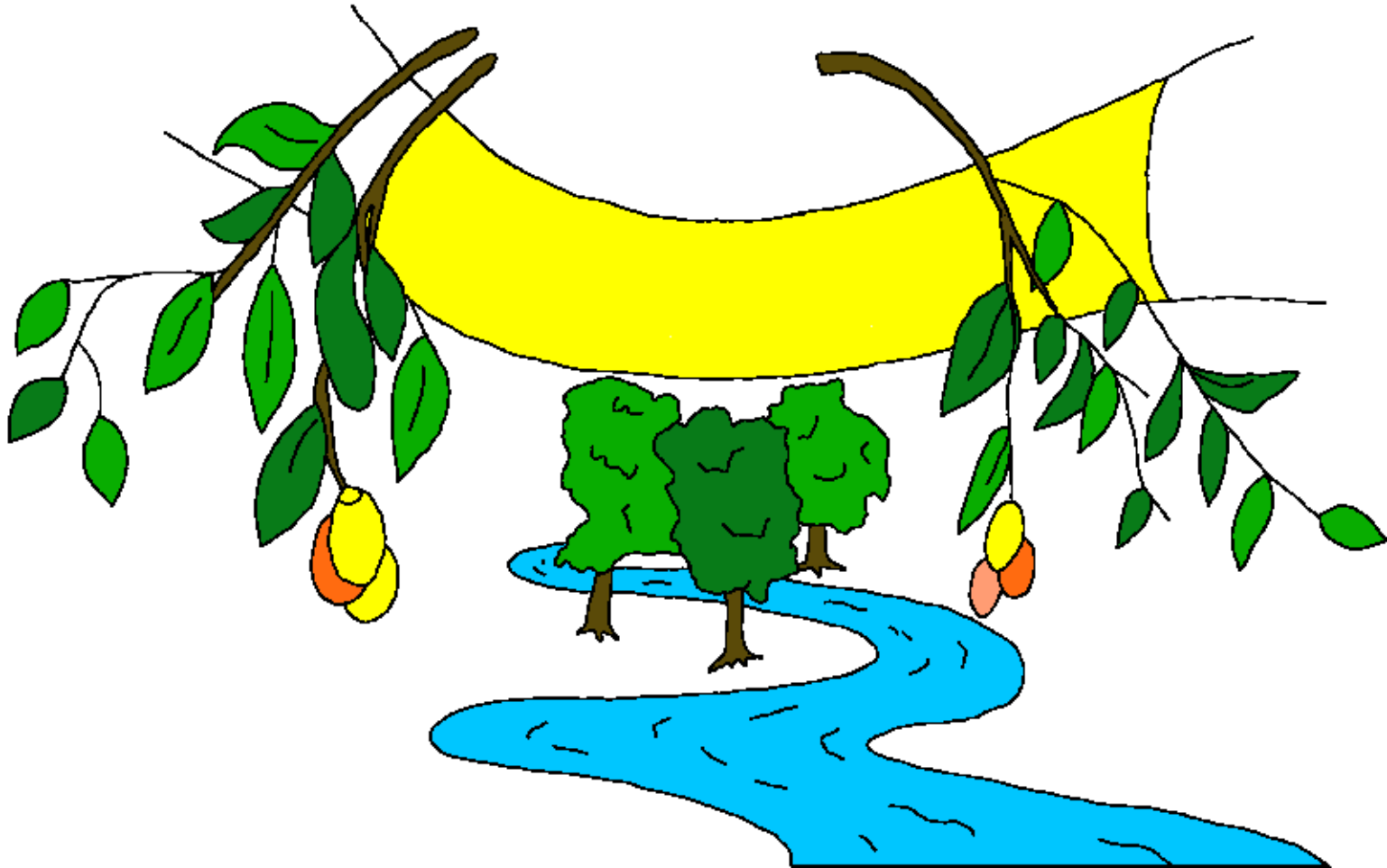

Jesucristo queja catyatitsutu yuneri tsujema
einajaca juishuque, Ijahuaja etiquiju enubidiruuque.
Ejeque ijicara juyaque, jecue. Tsujema ijinacue ena
maju baecua ishuque.

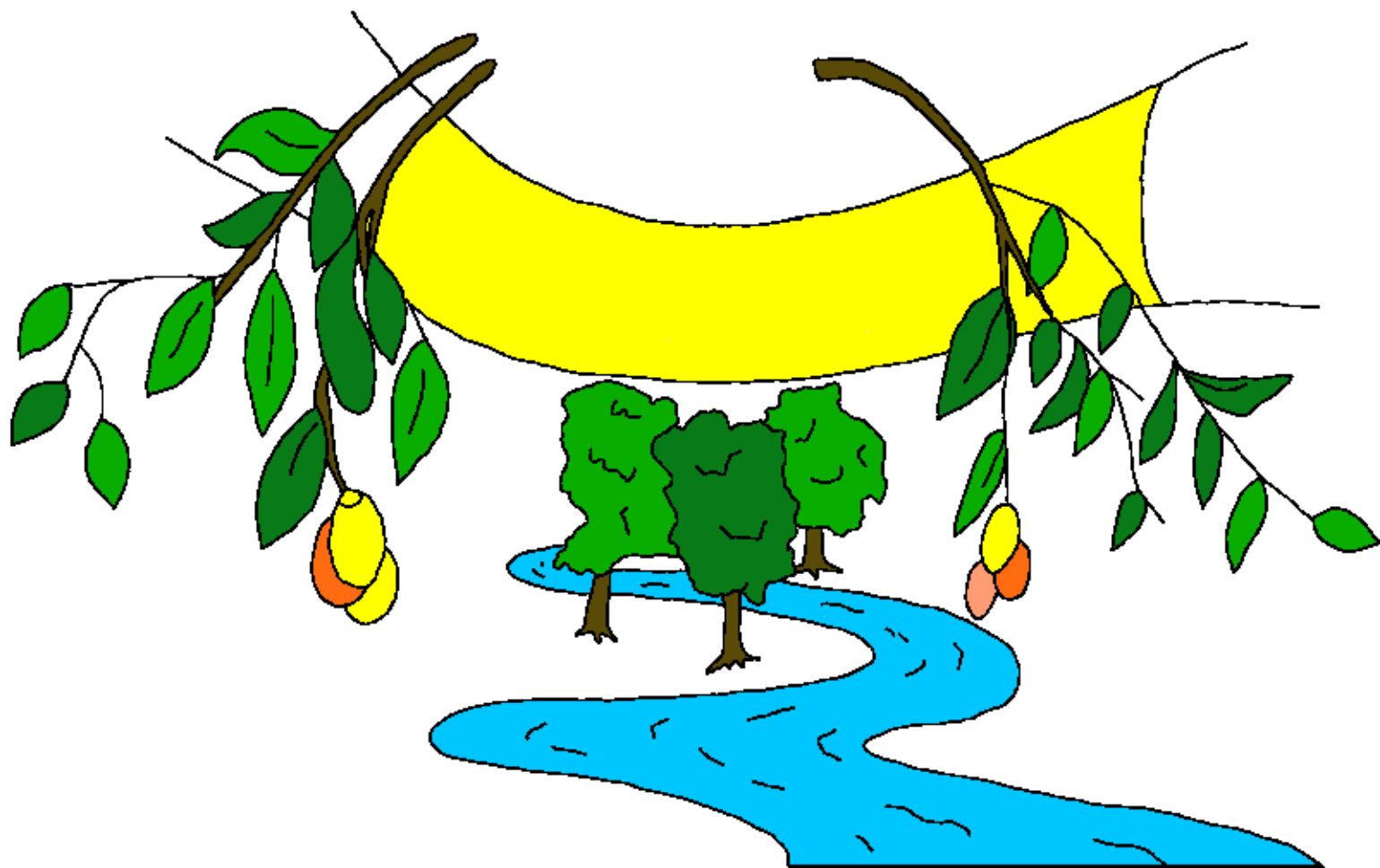

Yusuratu dutya
dyaque iyuhueda baya. Jadya tibudya
tujatu tuja peadyaque Ebacuaque
ecuana jiteque maju ishu cuadishahua.
Tuja Ebacuaque queja ni ecuana
catyatiya, ijahuaja etiquiju
ecuana judirubuque ama.
Yusu tsehue ecuana
anisiribuque.



Romanos 3:23 Dutya ecuana jucha aridaque. Aijamatu ni ejeque buchique Yusura amerecara aya eque juyaque, ni peadya buchique.

Romanos 6:23 Jucha arida tibu ecuana maju aqui, mere pujira mere juya tibu etsujequi inaya bucha. Yusura bacue ecuana tsujema neri Satanás quejaque inajacamereya ecuana, Ecuana Cuatsashaqui Cristo Jesús queja catyatihua baatsu. Tura ecuana inajacamereya majunuca ishu ama, tuatsehue ani ishu.

Hebreos 9:27 Maju pidya cuita camadya ecuana juya. Tuequedya ecuana Yusura cuejabuque eje bucha judadiyaque ecuana riyaque yahuaju eje bucha juhua eque.



Efesios 2:8,9 Yusura ecuana Ijahua quejaque
inajacamereya ecuana Jesucristo queja catyatihuaju.
Inajacamereya tura ecuana ecuanara ai jida ahua baatsu
ama, ecuana tsehue dyaque jida juatsudya jutidya.
Aijamatu ni ai ecuanaja jida aishuque Yusuja ecuana
tuaqueja judirusha ishu. Jadya ama juatsu ecuana
ecasumitiu jutidya, ecuana aiju jida baatsu Yusura
inajacamerehua bucha cabatitsu. Yusura ecuana
inajacamerehua tsujema neri. Ai tura ecuana yanacana
tyau ahuaque buchique tume.



Romanos 10:9,10 Ecuánara "Jesús tu Ique
Cuatsashaquique", jadya quisarati ayaju Yusura
ecuana Ijahua quejaque inajacamereya. Ecuánara
yuneri cuitadya Jesús emajuque chacha
netitsuranucahuaque ejeneyaju, Yusura ecuana
inajacamereya. Dutya ducuta Jesús queja
catyatihuaju, ecuana Yusura jucha metse ama baya.
"Jesús queja ique catyatihua", jadya cacuejatiyaju,
ecuana Yusura inajacamereya.



Juan 3:16,17 Yusuratu dutya dyaque iyuhueda baya. Jadya tibudya tujatu tuja peadyaque Ebacuaque ecuana jiteque maju ishuhua. Tuja Ebacuaque queja ni ecuana catyatiya, ijahuaja etiquiju ecuana judirubuque ama. Yusu tsehue ecuana anisiribuque. Yusuratu riyaque yahuaju cuanaque nerecaturacarama acuare. Jadya tibudya tujatu Ebacuaque riyaque yahuaju cuadishahua, tuaqueja catyatiya cuanaque inajacamere ishuhua, tuna ijahuaja etiquiju judiru ishuhua ama. Riyaque tu Yusura cuejacuareque: "Era micuana tere baecua anishaya. Micuana ecue ebacua queja catyatihua tibu, era micuana tere baecua anishaya".



1 Juan 5:11-13 Yusuja Ebacuaque queja ni ecuana
catyatihua, tume ecuana iyacuanetanahua. Majutsu
ecuana Yusu queja judirubuque ni eje tupu jaca ishu
ama. Yusuja Ebacuaque queja ni ecuana catyatima,
iyacuanema ecuana. Tume ecuana Yusu
tsehue anidirubuque ama.

Micuana era quirica cuadisha ishu ayaque
Yusuja Ebacuaque queja micuana catyatihua. Jadya
tibudya micuana iyacuanetanahua. Majutsu micuana
Yusu queja judirubuque ni eje tupu jakanuca ishu ama.
Cuadishaya rique micuanaja quirica,
micuana pana adebamere aishu.



Juan 14; 2 Corintios 5; Apocalipsis 4, 21, 22

Storyline by: Edward D. Hughes

Illustrated by: Lazarus
and Alastair Paterson

Adapted by: Sarah S.

Cavineña Bible (cav) © 2011, Wycliffe Bible Translators,
Inc. All rights reserved.

<https://www.bible.com/bible/538/MAT.1>

©2024 Bible for Children, Inc.

www.M1914.org

www.bibleforchildren.org

