

www.BibleForChildren.org



Juan 14



Jéyacsi Jesús: —Jam ra' cajotyiti cōjtyi'cān mi'in,
cūtiĉam' Jen'che' mi'in, yūche' chime' cūtiĉam'.
Jen'si'che' bā'yedye' yū mō'ya' dai' vavdye' in. Mu'che'
ra' jā'mij jījcaij yū, yū ra' yū'tyeyeyac vavdyes mi'in.
Jam me' bu'yi' jūijya', a vuty jam me' jéyac u.



Mu'che' ra' yu jäm' yu'tyeyeyac vavdyes mi'in, a ra'
me'si' juijya', chat qui ra' ca'ñibun yu jäshadyeyac,
mu'che' ra' pen'dyetyuyac mi'in, yöche'dyem' yu u.



Yü Juan vojity mi'in, mu' Jesucristo vaj cäts
ayo'bu'yi tsundyes, vaj cäts chime' tyum'chutiâa'
ñibedyesya', mo' jî'çojtyeja'si'

Jesucristodyesi' tsun.

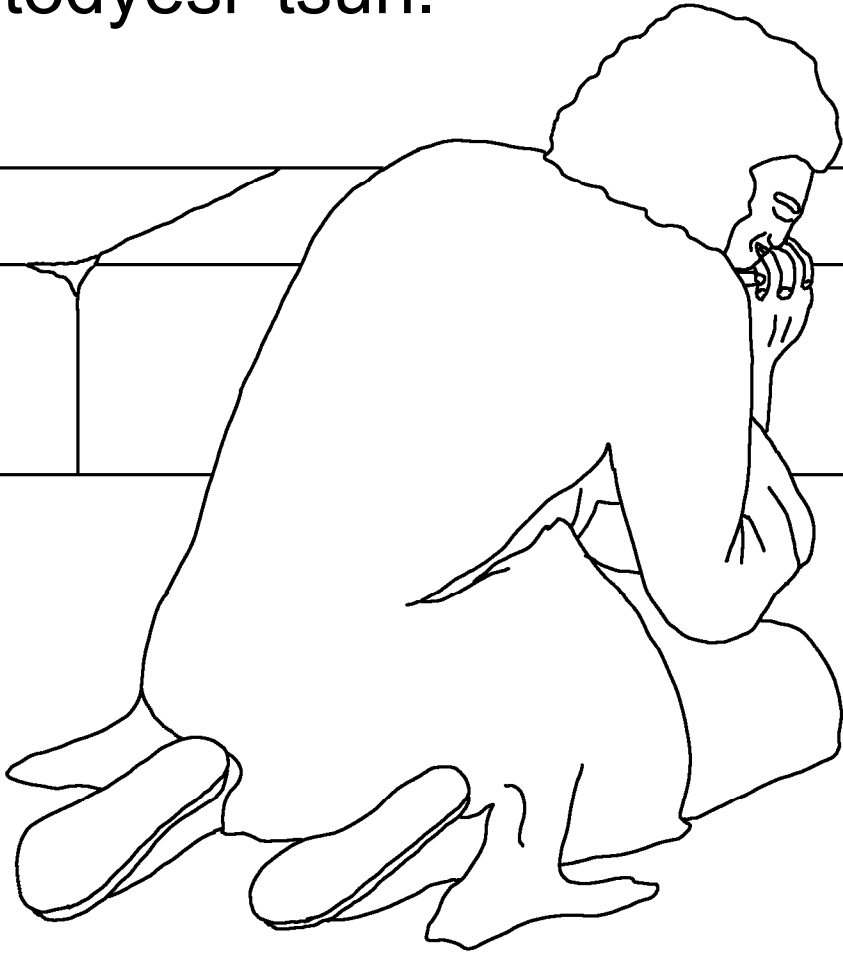

Jesha', yu va'cac marcânsi'che' poçho' mu'che'
câ'râij yu voro'yedyes Jen'si' pëyacdye' mu',
mo' pëyes Jesucristo. Mo' poçho'

Patmos tij mo'.

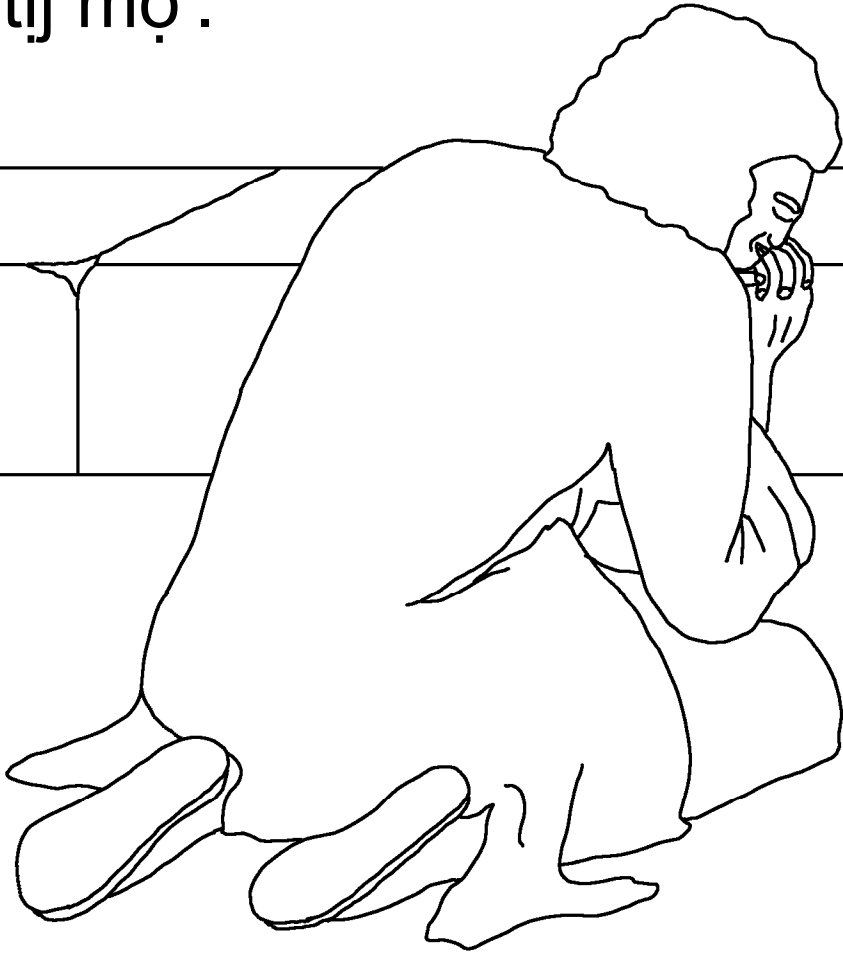

Me'candye Jen'si' A'edye' mu' tšútyin yu,
mọ'che'dye nąjbite yu ayos bą'yaquis mu'
mọ' mąyedye'ches, mu'che' cąveteij
bą'va'joiij.

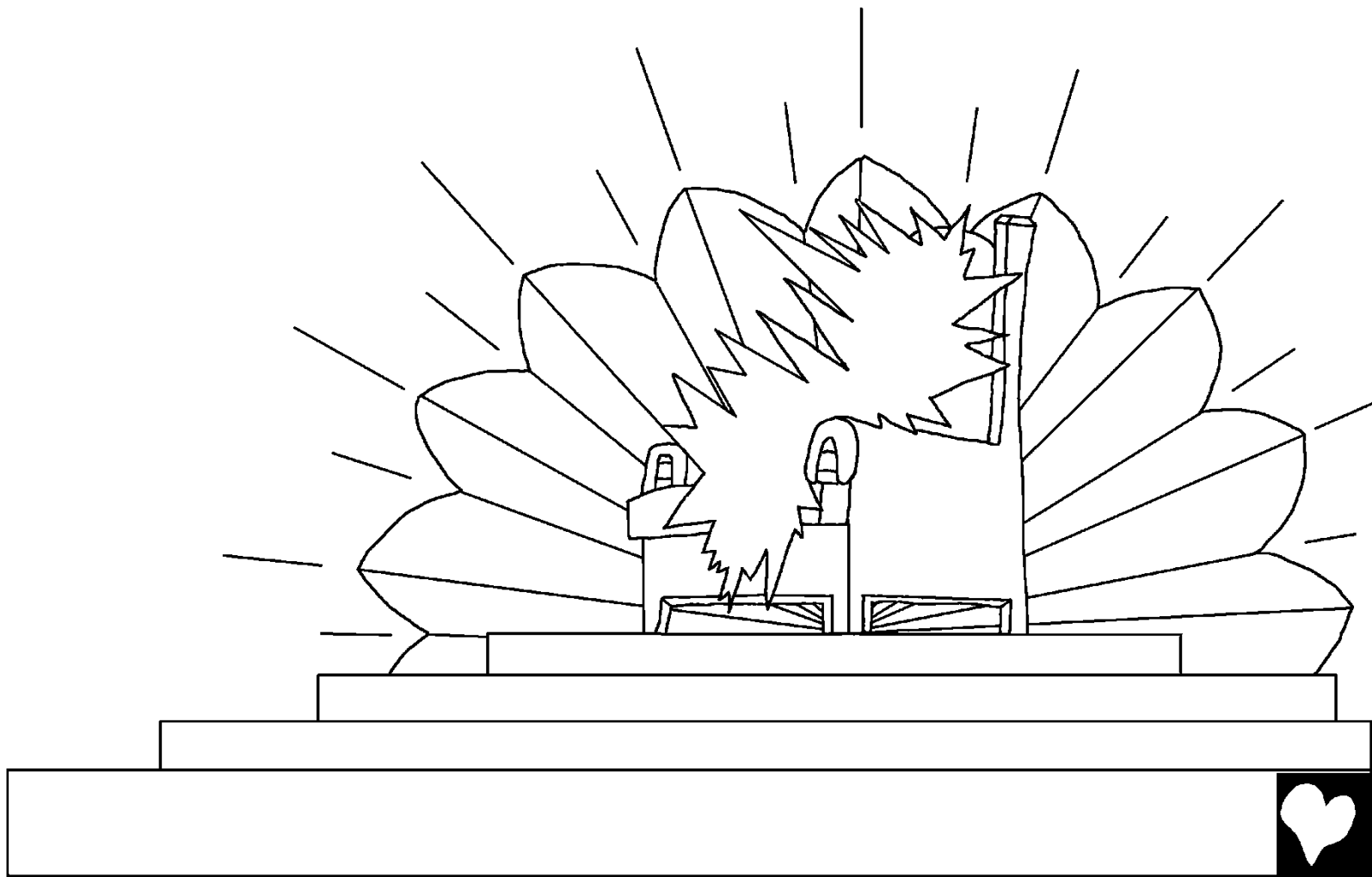

Me'candye yu se'vacsebi tima'cacdye' räj jäm'tacdye'
Jen'si' mu', mayedye'chety in judyeya' jacchety in
judyeya' jaccan bä'yity in, judyeya'
marcansi' chime' in, me' me'
se'vacsi yu.

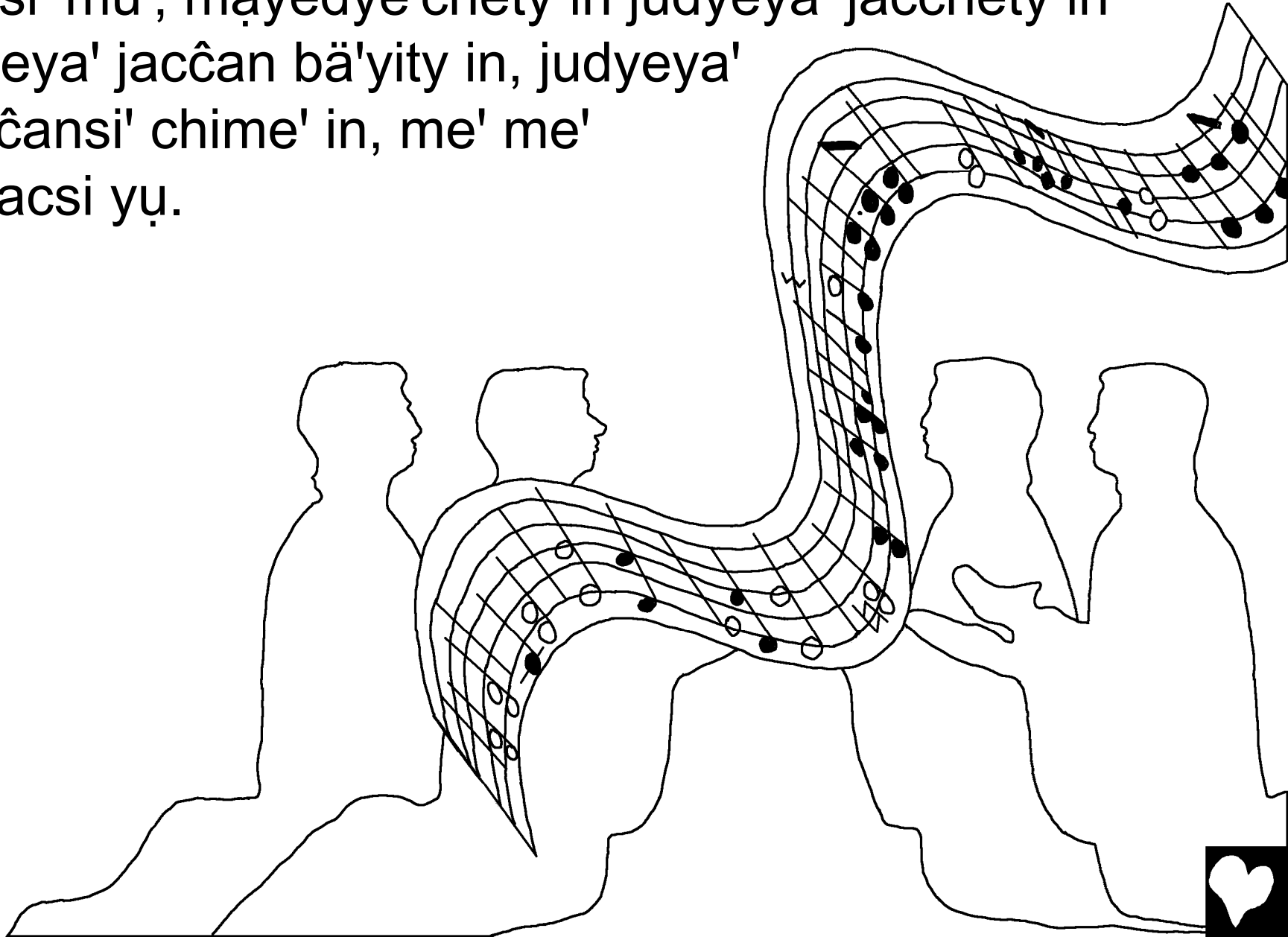

Yi in: judyeya' mu' Oveca bu'yity chime', yoshoropaij
jéyacseja', ĉaĉaij na ferdye'tumtyi' in, judyeya'
majquedye'tumtyi' in, paj jam
ju'ñiŝĉan mayedye' m̂otsi'
tima'cacdye' mu'in", yi in.

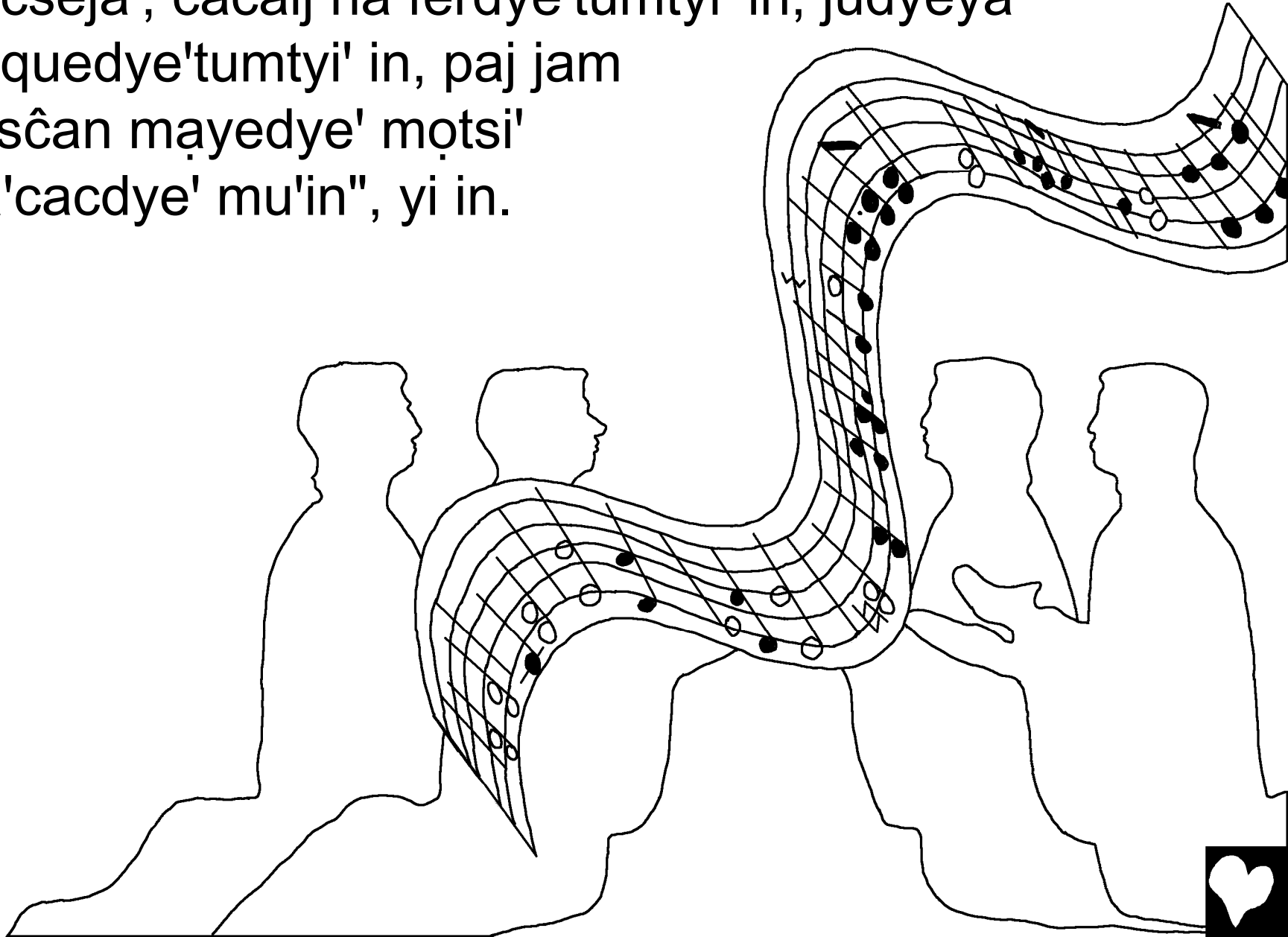

Yü çavepte Jen'si' bä'yedye' mu' mọ' nash müi'sis
Jerusalén, məyedye'che' jıjtui', Jen'yas ayij mọ'. Jeñej
yiris p̂en v̂amis ra' jä'mii'tyi' v̂amedyedyes mọ', me'
bu'yi'dye mọ' bä'yedye' yu'tac. Se've' yu fersi'
məyedye'ches p̂eyacdye' bä'yaquisches, yi': —Quin'
mu' Jen' aty
jajbu'yacsi
muntyi' in. Mu'
ra' jajbu'yacsi,
ç̂üi'tyi' ra' muntyi'
shupqui mu'. Jen'dye
ra' pen'dy Tucsi,
mu'dye ra' Jen' mu'in.

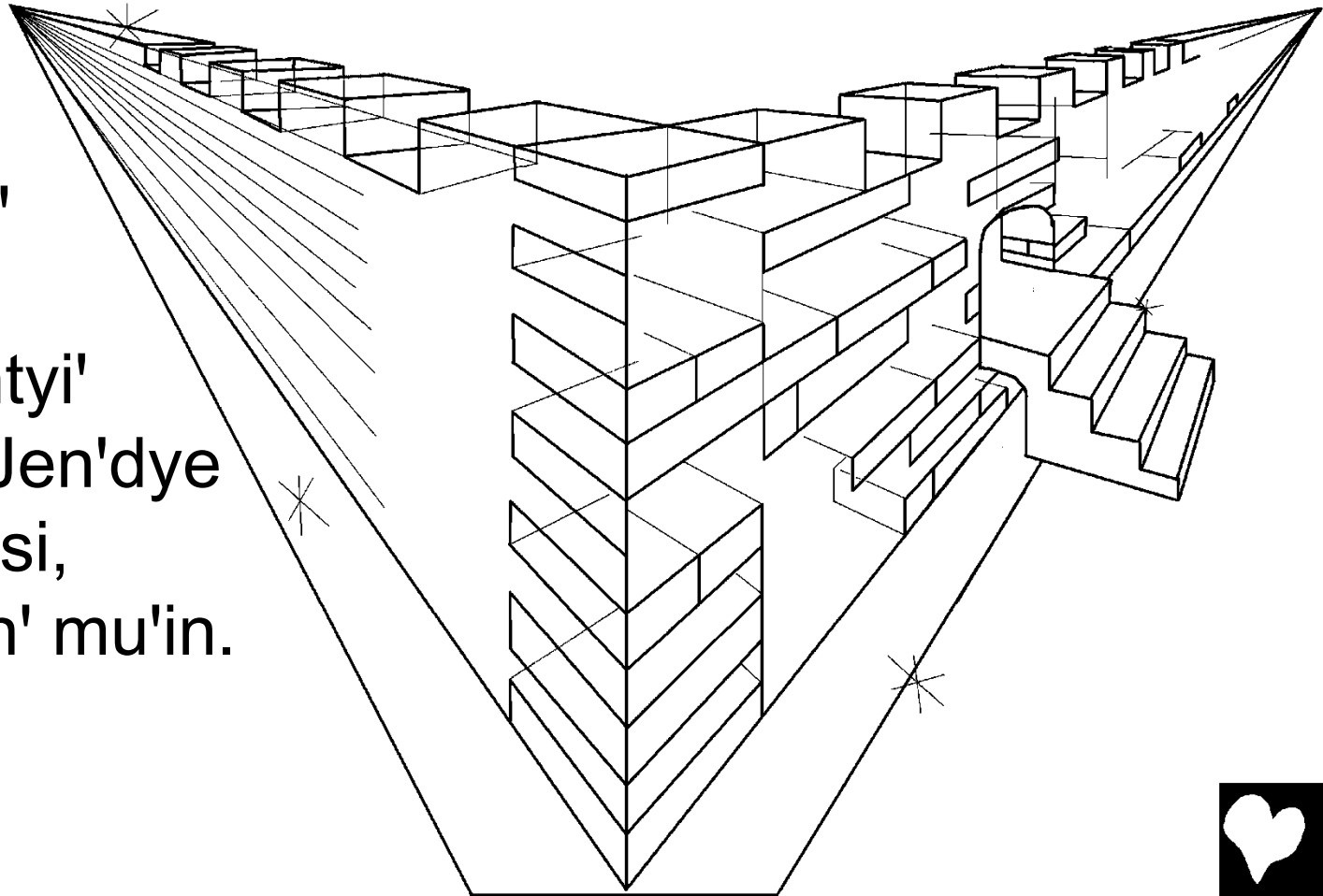

Mọ'ches bā'yedye' jam jemoñe' majquedye'
tsunsim' mijam ivas, çui'sim' majquedye' Jen'sim',
mọ' maj bu'yi' mọ'che', judyeya' mu' Oveca bu'yity
maj bu'yi mu'che' chime'.



Mọ' qui na ram' a'çhis jedye' jam
jun'yi' siti' mọ'che'. Tyi chuc
a'çhistum tsı́cadye' bä'yi
in mu'in ra' jam jun'
cänä'vaqui in mijam
väväjñity chime' in.
Mu'in ram' sánactyi'
tij quircache' in Oveca
bu'yitysi'che' mu',
mọ' jı'jäcacsis mu'in
Jen'ya' ra' bä'yity in,
mu'in ram' siti mu'çan in.



—Jen' ra' ji'tätsacsebi táris
mu'in, jadyic ra' sän'dye' mu'in,
jadyic ra' táredye' mu'in
judyeya' vátedye' chime' mu'in,
aty ra' jam jî'çojtyeban' quivij
are'redye' in, räj mọ' tashches
jî'çojtye'si' jiquej in, räj ra' mọ'in
jî'motsac in —yi' mọ' pêyacdye'.



Räj jäm' bu'yi' mọ'che', jam jeñej tashchesân jac
jiquej, mọ' çai'si' va'tacdye' Jen'si' jiquej mu'. Mọ'cân
ra' bä'yi' bä'yaquis Jen'si' mu' judyeya' Oveca
bu'yitysi', mu'cân ra' ayo'bu'yi in. Çui'tyi' ram' úñity mu'
tima'quete in. Mu'in ra'
vejya' çavete in, vaj
vejti ra' mu'tum in,
tij ra' mu' me'chupte
jáfiche' mu'in.



Chime'dye çavacseban yu räj mu'in säñity jiquej in,
muju'chaty in judyeya' uya'yaty in, mu'ya' mu'in in
Jen'si'ya' vej in. Chat qui vanchuc mo' quirca in
judyeya' yocsi' quirca chime' vanchuc, mo' ji'jäcacebi'
tij Jen'ya' ra' bä'yity in. Chat qui mu' Jen'
ji'cäts yu'tacsi mu'in säñity in jun' jun'
chuc sánac quircache' in, jun'
jun' chuc bä'yaque
jacche' jiquej in. Tyi
chuc jam sánactyi' tij
in Jen'si'che' quirca
mu', mu'in me'tyity
in va'cac tîjîcan in.

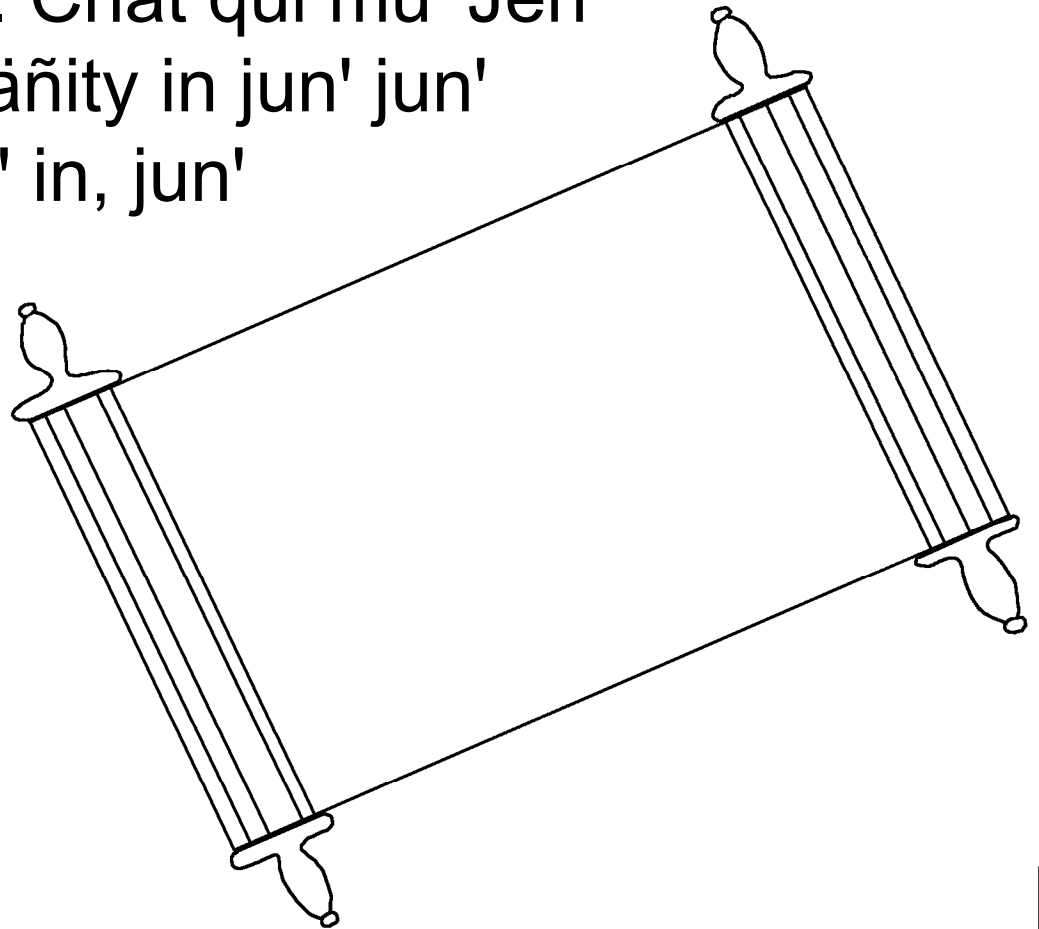

Jen'si' A'edye' mu' vaj cäts Jesústyitum muntyi' mu',
mu'in nash Ovecas bu'yi êpen in, mo' vâmis ra' mu'che',

mu'in yi jéte in: —¡Atsiva! Tyi chuc se'vacsebi
êpeyacdye' mo'in, paj mu'in yi chime' in: —¡Atsiva! Tyi
chuc jajri juijya' in, tyi chuc ma'je' ñibe'jeyac juijya' in,
paj atsij
fibi'ya'
ra' tyeij

in mo' ojñi'
tsa'chucsis.

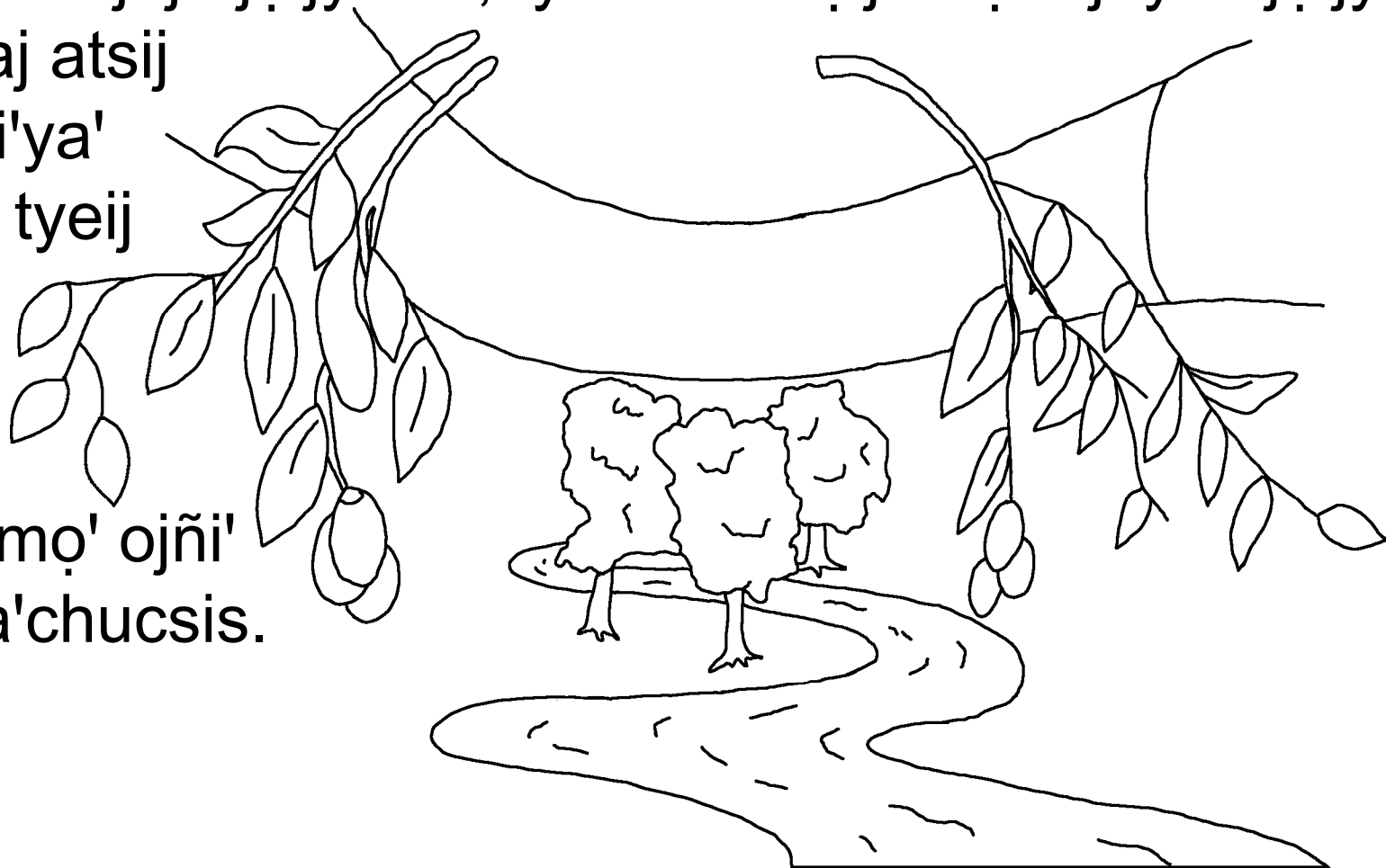

Mu' Jen' fer ma'jeyacsi jacchety
muntyi' in, me'dyes qui mu'
yu'taqui mu' yiritytyity Ava' mu'.
Tyi chuc anicjete in mu'in ra' jam
cave' san'dye' in, rajcan ra'
Jen'ya' ba'yi in.



Romaçantyidyés 3:23

çâçaij na räj juchajtum bä'ja' úchety tsun, anic moch bu'ja', mijam çheï'ya' bu'ja' Jen'ya' mu' majjquedye'tumtyi'ya' Jen'.

Romaçantyidyés 6:23

Mọ' ya'itacdye' juchaijtyidyés in, sän'dye' ra' so'mac in. Mọ'ya' chime' mọ' ñibe'yedye' so'misin'si' Jen' Jesucristoty tsun, mu' nash Ayo' tsun, mu' so'misin' paj qui räjçan Jen'ya' bä'ja' tsun.

Hebreodyés 9:27

Me'dye çuin' räj muntyi' in yiri' quim' säñi in, chat qui ra' mu' Jen' jì'cäts yu'tacsi juchadye'ya' mu'in.



Efesoântyidyés 2:8,9

Jen' ñibe'jitidyésya' mu' ji'çhonnac mi'in anicyedye'ya' mi'in, mijam jun' bu'yi tupuj çui' ji'çhonti mi'in, ñibe'jitidyésya' mu' ji'çhonnac mi'in. Tsun jam çui' tupuj ji'çhontiça' tsun jun' chuc ruij bä'ja', mọ'dyés jam jun' tupuj çui' va'bunyeja' tsun jun' chuc mọ' çon'dyedyés tsun.

Romaântyidyés 10:9,10

Tyi chuc peijte mu' Jesús yi: "Mu' Jesús anicityity Ayo' tsun", judyeya' chime' anicyi çojtyi'çan mu', jun' chuc mu' Jen' vañinjebajte jiquej, mu' nash ra' çoñi. Jemoñe' çojtyi'çan anicjeja Jen' paj qui mu' ruij yu'sin' judyeya' peyacdye'ya' mu' ji'jácja Jesucristo, chat qui ra' mu' Jen' ji'çhonsin' tsun.



Juan 3:16,17

Mu' Jen' fer ma'jeyacsi jacchety muntyi' in, me'dyes qui mu' yu'taqui mu' yiritytyity A'va' mu'. Tyi chuc anicjete in mu'in ra' jam ca've' sa'n'dye' in, ra'jcan ra' Jen'ya' ba'yi in. Jen' jutaqui A'va' mu', jam paj qui va'tacdye' so'macsi jacchety muntyi' in. Dam'dye mu' jutaqui A'va' paj qui mu' ji'chonacsive muntyi' in.

Tashches Juansi' 5:11-13

Oij peyacye' ji'cha'quiyisin' jun' chuc mu' Jen' tsa'chusin' tsun paj qui Jen'yadyety tsun, chimo'dye ji'cha'quiyisin' tsun jun' chuc mu'dye A'va' mu' tsa'chusin' tsun. Mu'in me'chuptety in Jen'tyi' A'va' mu', mu'in Jen'yadyety in, tyi chuc jam me'chuptety in mu'in jam Jen'yadyety in. Oij quin' sa'ne' yu' mi'indyas anicjeptintety Jen'tyi' A'va' mu', yu' jeyac oij paj qui jam' chij mi'in, mi'in aty Jen'yadyety mi'in.



Juan 14; Jäqui'ves Corintoçantyidyees;
Ji'cavacdye' 4, 21, 22

Storyline by: Edward D. Hughes

Illustrated by: Lazarus
and Alastair Paterson

Adapted by: Sarah S.

Tsimané Bible (cas) Copyright 2017 Nuevo Testamento
en Chimane Jen'si' Peyacdye'

<https://live.bible.is/bible/CASNTM/GEN/1>

©2026 Bible for Children, Inc.

www.M1914.org

www.bibleforchildren.org

