

San Juan 14

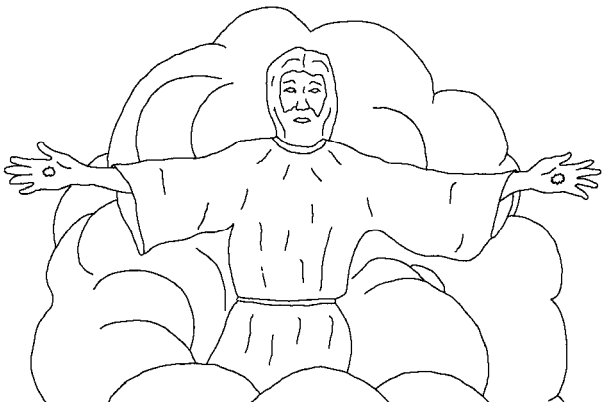

Faa²¹gi Jesús: –Jo cwotaan²¹²naa' cu²-'oo'. Jo jmaa^{2aa} cuu¹³-'oo' coon¹³ Dios jon'gi cuu¹³-'oo' coon¹³ jna jon. Fu li tyiin¹ Nu^{3uu} joo²¹ 'áa'mo li cwá^{2a} tsá². Wa jo la joon fí² nifuu²¹²oo 'naa'. Joon inii¹³na nityii^{3aa} tyú² coon²¹ li ní³ⁱⁱ'.



Nii¹³na nityii^{3aa} tyú² joon mi yui¹³ joon yíia^{3oo} tún¹, yatee^{2ee} 'naa', tsaa^{21a} coon¹³ jna. Joon coon¹³ la joon ili'yii^{21a} coon¹³ jna li tyiin¹³na.

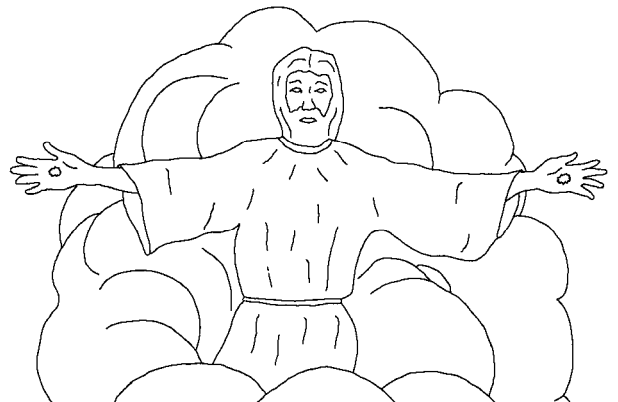

Jna-a, Wó³, 'in líi¹i ruu²¹naa'. Jna 'in caan²¹
moo coon¹³ 'naa' jilaa²¹ wúu¹ 'e nee²¹e'.
Tyú² Dios to² jna' la 'oo²¹ tsaru¹u'

joon gauncoon¹³on
Jesucristo jna' 'e



seen²¹na' 'e feei¹-tsi'.
'Yuu²na 'nũñi³ coon²¹
lí sii²¹ Patmos.

3

Patmos do coon²¹ cwoo¹³ tyú² roon¹ tún²
tsa¹ ni jmiñi¹. 'Uu²¹uu 'nũñi³ tsu
'wii¹³ nigacwó²oo júu³ tyú² tya'

Dios joo gafo¹ oo 'wii¹³
tya' Jesucristo.



4

Joon tsifu gasaa²¹i 'in Espíritu Tyú² tya' Dios jna joo
gamóo³oo si² fu nũfú² coon²¹ lí sili²¹². Joon tyiin¹mo
jaain²¹ 'in tyiin¹ lí tyiin¹ tsafeei¹ lí sili²¹² do.

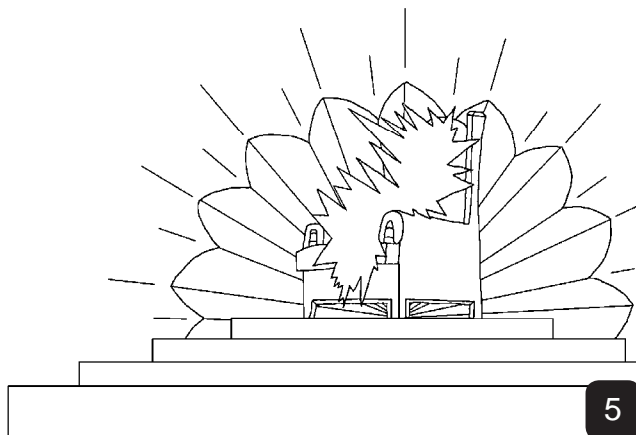

5

Joon ganúu³oo faa²¹a jilee²¹ 'in taain²¹² fu ñũfú²
coon¹³ 'in taain²¹² ni cwoo¹³ juncwii²¹ coon¹³
'in taain²¹² lí' cwoo¹³ nũ' coon¹³
'in taain²¹² nũ' jmiñi¹³ coon¹³
jilee²¹ 'in taain²¹² do gajin²in:

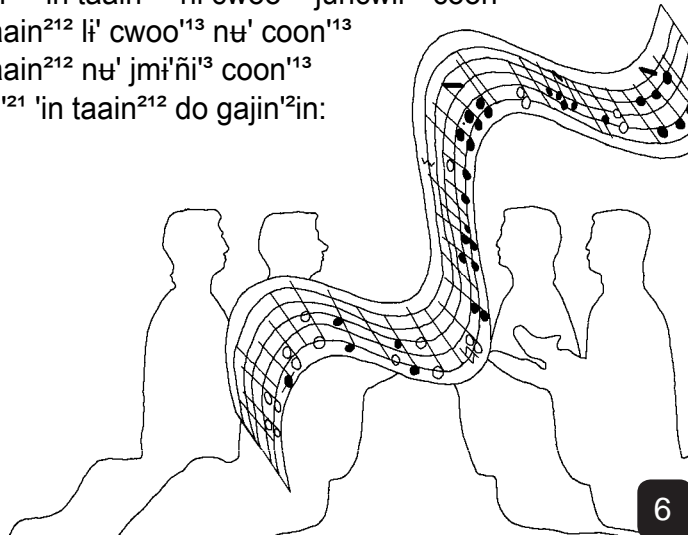

6

Cwoli² tya' 'in tyiin¹ lí sili²¹² do jilaa²¹
'e 'ø¹ tsá² coon¹³ jilaa²¹ 'e un'goo¹
tsá² coon¹³ jilaa²¹ 'e 'ya²gi coon¹³
jilaa²¹ 'ii²¹ 'e sá². Cwoli² jon tya'
'in joo'saa²¹ xuui²¹² do
jilaa²¹-a coon²¹ tøø²mo.

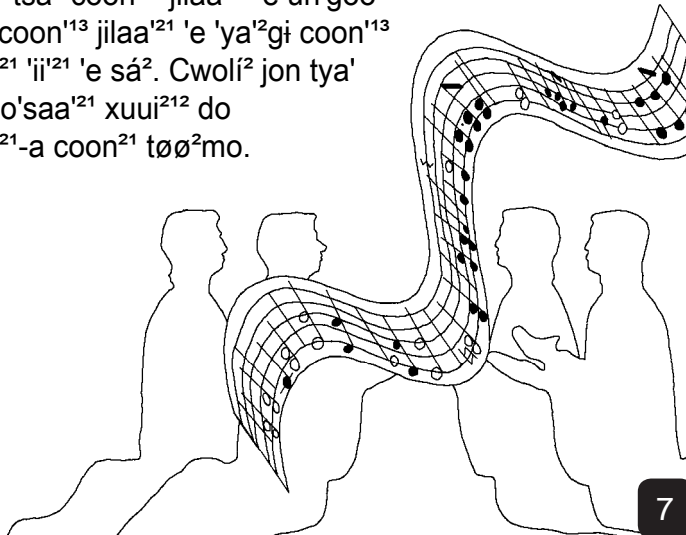

7

Joon jna-a, Wó³, gamóo³oo gajgo¹o coon²¹ fuu²¹
nicwaa¹³ 'e sii²¹ Jerusalén 'múui². Gajgo¹o fu ñũfú² lí
tyiin¹ Dios Jmii²¹. 'Ya²gi 'áai¹ 'e fuu²¹ do lawa jaain²¹
simi² nináa¹ tyú² siin¹³in 'ya²gi icui² cwoo²¹o.

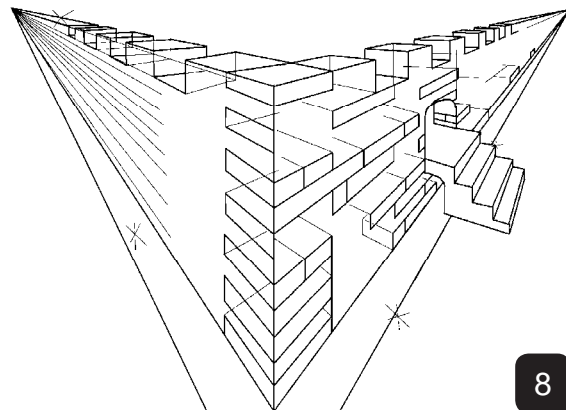

8

Joon ganúu³uun coon²¹ júu³ tá² jó² fu ñu¹fú² 'e jin¹²:
 –Jóø²du', taan¹mo Dios Jmii²¹ jee²¹¹ tsá². Joon itéin¹
 caan²¹mo coon¹¹³. Joon ilíi²in tsá² tya' Dios Jmii²¹ 'in tsá²
 taain²¹² juncwii²¹ joon Dios Jmii²¹ 'ña'a itéin¹ jee²¹² tsá²,
 ilíi²in Dios tya' 'in tsá² do.

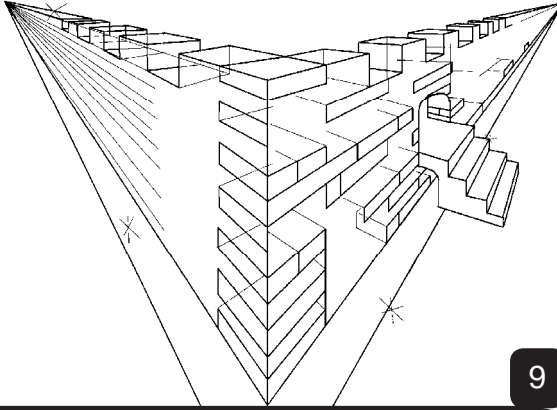

9

Joon 'in ángel do ga'e¹²e jna coon²¹ jmii²¹ fee¹ pii¹,
 jmii²¹ ilicwó² juncwii²¹ tya' tsá² 'e 'yeel¹²¹ li silii²¹² tya'
 Dios coon¹¹³ 'in Cordero do. Pii¹ 'e jmii¹ do 'e li la li
 cuun²¹² jii¹ cristal.

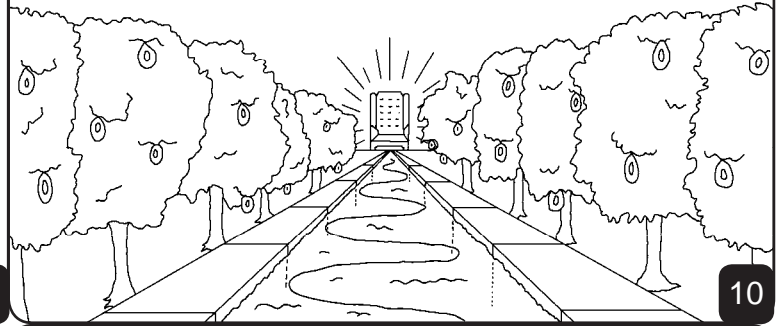

10

Joon 'e fuu²¹ do jo 'néi²gi ñi¹ 'e cwó² 'yiaa²¹ jon'gi sii¹²¹
 tsu jná² joo²¹ tya' Dios Jmii²¹ coon¹¹³ 'in Cordero do
 cwoo¹o 'yiaa²¹ tya'a.

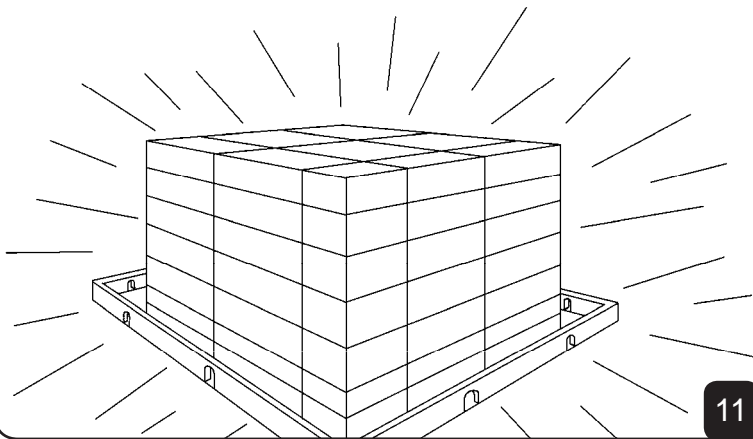

11

Joon jii¹¹³ jaain²¹ 'in
 røøi²¹ tsaa² itsatáa¹ 'i 'e
 fuu²¹ do. Jon'gi itsatáa¹
 'in jmoo¹o 'e loo¹ owa
 'in cón² tsá² tóo² 'ee.
 Jii¹¹³ 'in taan²¹²in ni jí²
 tya' Cordero, 'e jí²
 taain²¹² jileel¹²¹ 'in
 cwo¹o Jesús juncwii²¹
 'múui² tya'a 'itsatáa¹ 'i 'e
 fuu²¹ do.



12

Joon Dios Jmii²¹ iuntyuun¹un jilaa¹²¹ jmii²¹ tuun²¹un unni²
 tsá². Joon jo 'ee²¹ júin¹gi tsá² jon'gi tyi¹²gi tsá² jon'gi
 xuui²¹²gi-tsi jon'gi ní²gi wúu¹ tya'a 'e cuu¹
 tya'a tsu jilaa¹²¹ 'e sá² la mo jéel¹³
 ningíi²mo.

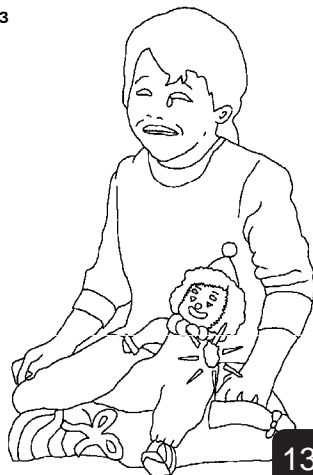

13

Joon fu 'e fuu²¹ do jo 'e sá²gi wa'a jo fi²-tsi Dios, tsu
 do-o si¹² li silii²¹² tya' Dios Jmii²¹ coon¹¹³ 'in Cordero joon
 'in jmoo¹o la to² tyu¹²u iun'goo²¹o 'ii. Joon iní² nii¹i, joon
 tya'tyi² toon¹on 'e sii²¹ 'ii²¹.



14

Joon gamáa³na 'in najúin¹ 'in cøøi¹³ tiin¹³ 'in pi³ teen¹in tyani Dios Jmii²¹. Joon 'e jí² do roon¹on sinii¹³ joon ganá¹ coongi jí² li taain²¹² jilee¹²¹ 'in cwo¹o Jesús juncwii²¹ 'múui² tya'a. Joon gajmaa¹a 'ii²¹ tya' 'in najóin¹ do jiin¹³ la nigajmaa¹a jiin¹³ la taa¹³ 'e jí² do.

Joon fu do-o ipii¹in Dios jilee¹²¹ 'in jo taain²¹² 'e jí² do li taain²¹² jilee¹²¹ 'in cwo¹o Jesús juncwii²¹ 'múui² tya'a.

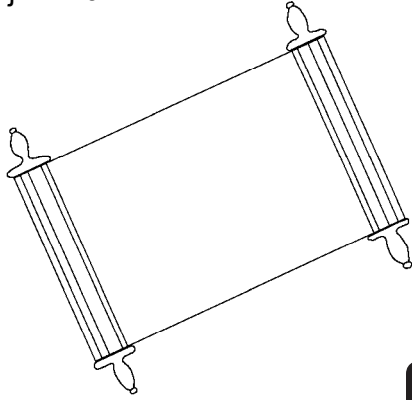

15

'In Espíritu Tyú² tya' Dios Jmii²¹ jin²in, la joon jin²in 'in tsá² 'in fiii¹ lawa'a tsamí² tya' 'in Cordero do: -¡Na!¹ Joon jilee¹²¹ 'in núu²un júu³ tya'a jin²in: -¡Na!¹ Níliin²naa' jilee¹²¹naa' 'in unjmí¹i. Níliin²naa' jilee¹²¹naa' 'in 'iin²¹²in 'uun²¹ jmi²¹ 'e cwo¹o juncwii²¹ tya' tsá² 'e jo 'e 'laa¹³ tyiin¹.



16

'Tsu 'áa¹mo gali'in²¹²in Dios tsá² taain²¹² fu juncwii²¹, tsu 'wii¹³jooon gacwóo¹ 'i 'in jaan²¹mo Jóon¹on ijúun²in 'wii²¹² tya' tsá². 'E tya' jilee¹²¹ 'in jai¹² fiii² 'ii jo itsáa¹a fu li 'ii²¹ pe taa¹²¹a juncwii²¹ tya'a coon²¹ tøø²mo.

60

60

17

Romanos 3:23
Tsu jilee¹²¹mo niga'nóo²o tsaa² joon jiin¹³ jaain²¹ wa gaffi¹ 'i la 'iin²¹²in Dios.

Romanos 6:23
'E 'leei¹³ tsá² 'e jnaa¹a mo 'noo¹o tsaa² jiin¹³ 'e 'ná¹ júun²mo. Pe cwo¹o Dios tsá², jo 'e 'laa¹³ tyiin¹, coon²¹ juncwii²¹ 'e taa¹²¹a coon²¹ tøø²mo sicaain²¹ coon¹³ Ña'ñu¹'u' Cristo Jesús.

Hebreos 9:27
La joon jilee¹²¹mo tsá² 'ná¹ júuin² coon²¹ naa¹³ joon mi yuui¹³ joon ilisá² 'ii²¹ tya'a.

18

Efesios 2:8,9

Joon Dios gajmaa¹a tiin¹³ 'naa' coon¹³ 'e jai¹² fii²naa' tsu 'wii¹³ 'iin²¹²mo 'naa'. Joon jo gajmaa² 'naa' 'yaanaa' 'elo, pe Dios nigajmaa¹a tyi'naa' 'e jo 'ee 'laa¹³ tyiin¹.

Jo jmaa¹a Dios tiin¹³ tsá² tsu 'wii¹³ 'e tyú² 'e nigajmaa¹a tsá², tsu coon¹³ la joon jo lí² jme¹ 'i tsá² jloo¹³ yaai.

Romanos 10:9,10

Tsu wana coon¹³ júu³ tyi¹ 'i jmoo²o júu² 'e fiii¹ Jesús Ña'ñu¹'u' joon wana jai¹² fii²u 'e nigajmaa¹a Dios 'ii jiin¹ jee²¹² 'fii²¹², itiin¹³mo'o.

Tsu coon¹³ 'e 'i¹-tsi tsá² ja¹²mo fiii² tsá² wa'a iuntyú¹mo Dios 'ii, joon coon¹³ júu³ tya'a jmo¹²o tsá² júu³ 'e cwii¹in Jesucristo joon coon¹³ la joon tiin¹³mo 'ii.

19

San Juan 3:16,17

'Tsu 'áa¹mo gali'in²¹²in Dios tsá² taain²¹² fu juncwii²¹, tsu 'wii¹³ jooon gacwóo¹ 'i 'in jaan²¹mo Jóon¹on ijúun²in 'wii²¹² tya' tsá². 'E tya' jilee¹²¹ 'in jai¹² fiii² 'ii jo itsáa¹a fu li 'ii²¹ pe taa¹²¹a juncwii²¹ tya'a coon²¹ tøø²mo.

Jo gasii¹in Dios Jóon¹on fu juncwii²¹ wa'a jmoo¹o 'ii²¹ 'e júun²in tsá², gasii¹mo wa'a jmaa¹a tiin¹³ tsá² 'wii¹³ 'ii-o.

1 San Juan 5:11-13

Joon 'e júu³ jai¹² ga¹² fii² Dios cwáain¹ tya' Jóon¹on jin¹² 'e Dios nigacwo¹ 'jna' coon²¹ juncwii²¹ 'múui² 'e taa¹²¹ coon²¹ tøø²mo. 'Wii¹³ tya' Jóon¹on gacwo¹ Dios jna' 'e juncwii²¹ 'múui² do. Joon jilee¹²¹ 'in ngi¹ sicaain²¹ coon¹³ Jóon¹ Dios niga¹'ii²¹mo 'e juncwii²¹ 'muui² do. Pe jilee¹²¹ 'in jo jai¹² fii² Jóon¹ Dios jo mo ga¹²'ii²¹ 'e juncwii²¹ do. Nigasii¹'na 'e jí² lo tyii¹ 'in jai¹² fii² Jóon¹ Dios 'e litsáa¹mo-'oo' 'e niga¹'ii¹³mo' coon²¹ juncwii²¹ 'múui² 'e jo tyéi¹.

20

San Juan 14; 2 Corintios 5; Apocalipsis 4, 21, 22

Storyline by: Edward D. Hughes

Illustrated by: Lazarus
and Alastair Paterson

Adapted by: Sarah S.

Chinantec, Quiotepec Bible (chq) © 1983,
Wycliffe Bible Translators, Inc. All rights reserved.

<https://www.bible.com/bible/771/MAT.1>

©2026 Bible for Children, Inc.
www.M1914.org www.bibleforchildren.org

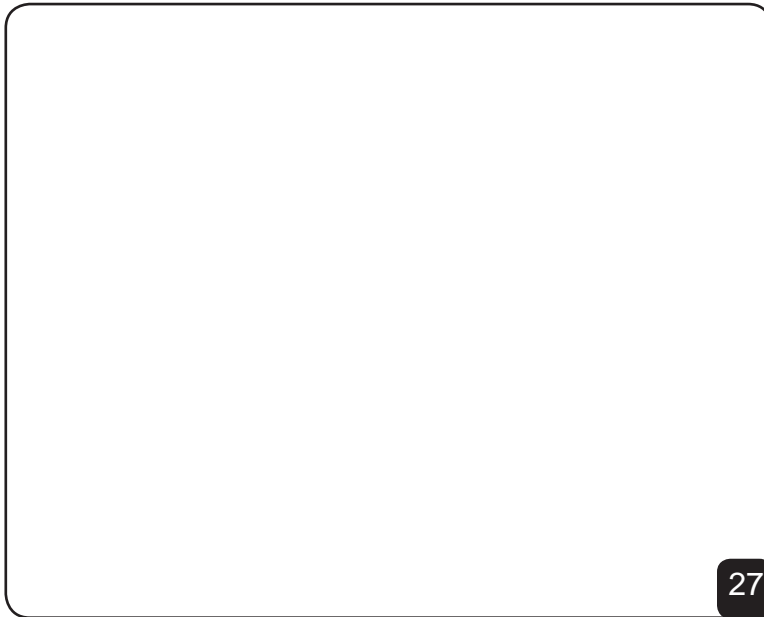

27

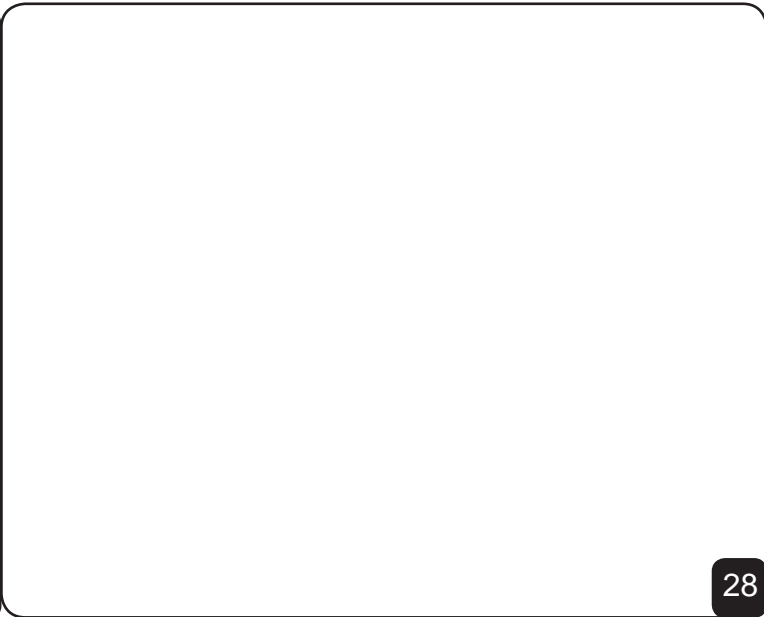

28

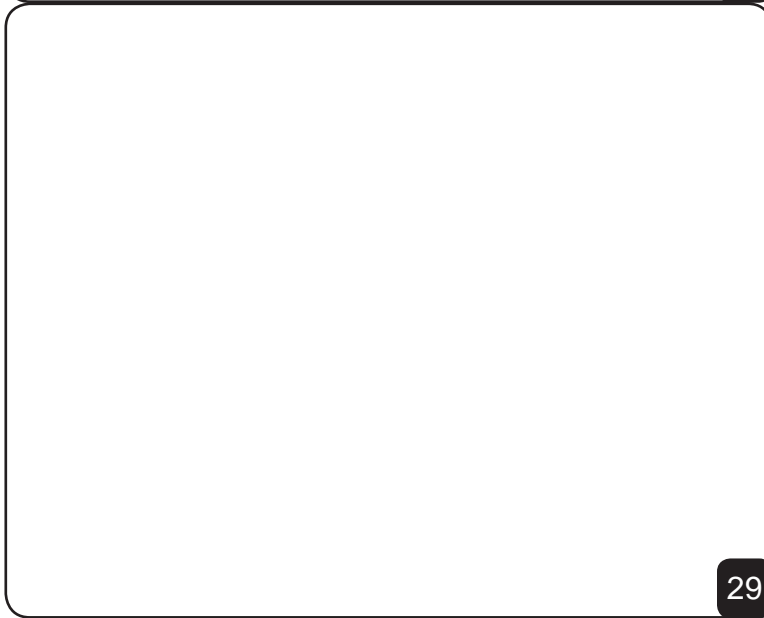

29

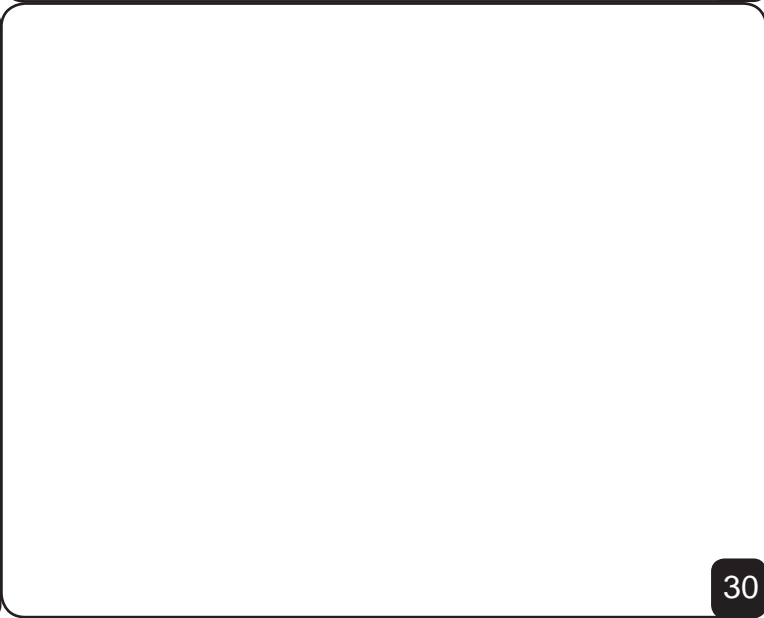

30

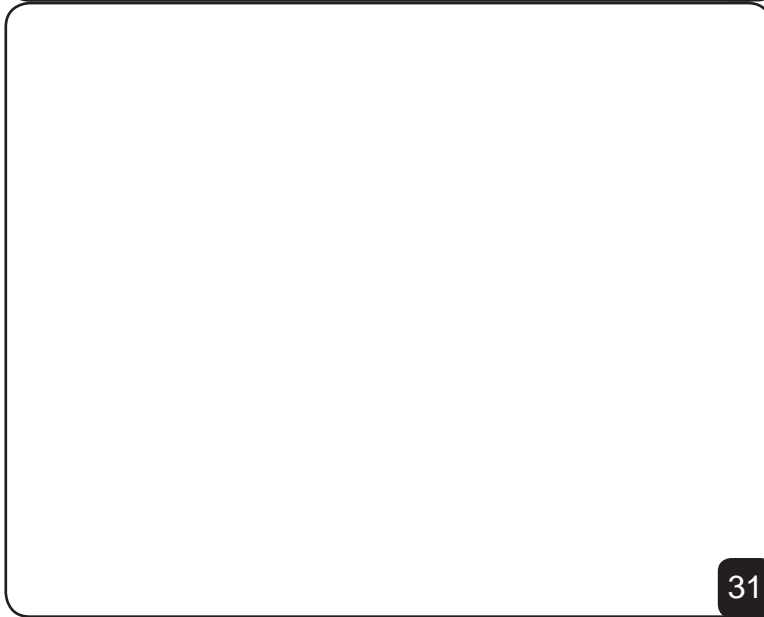

31

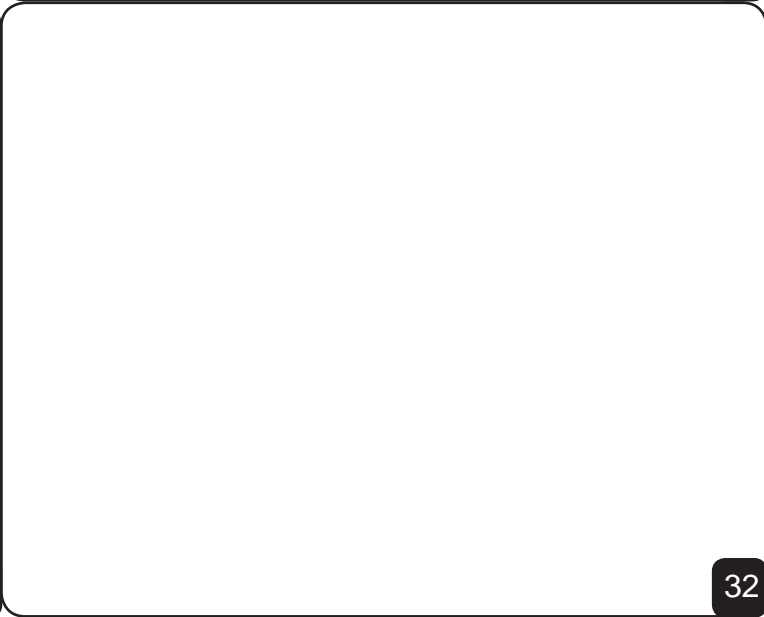

32

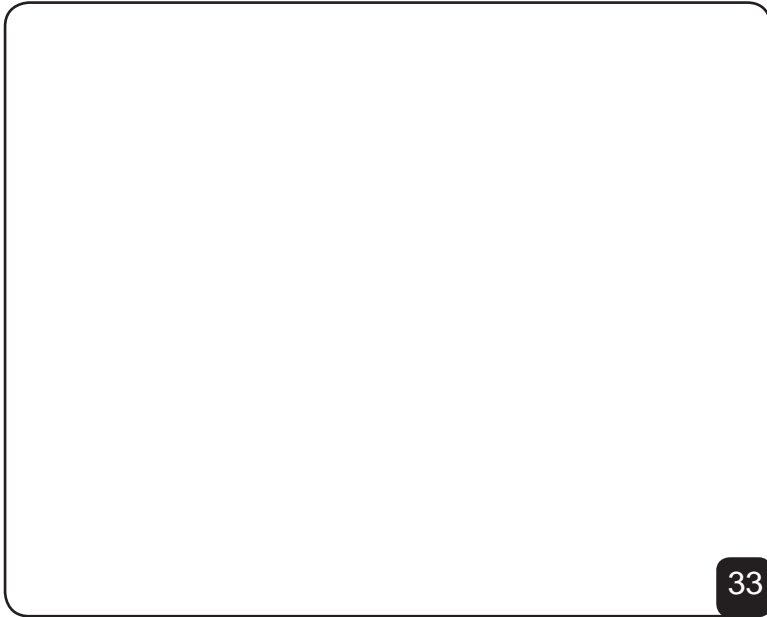

33

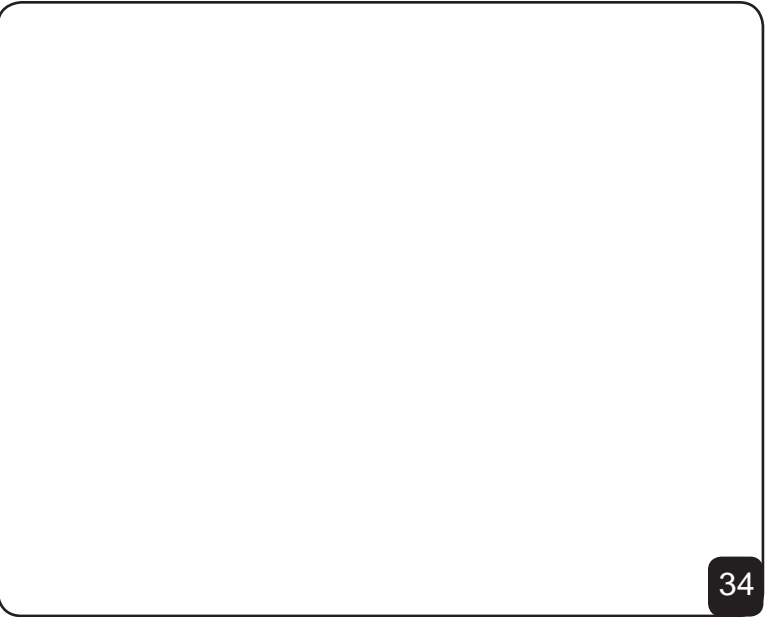

34

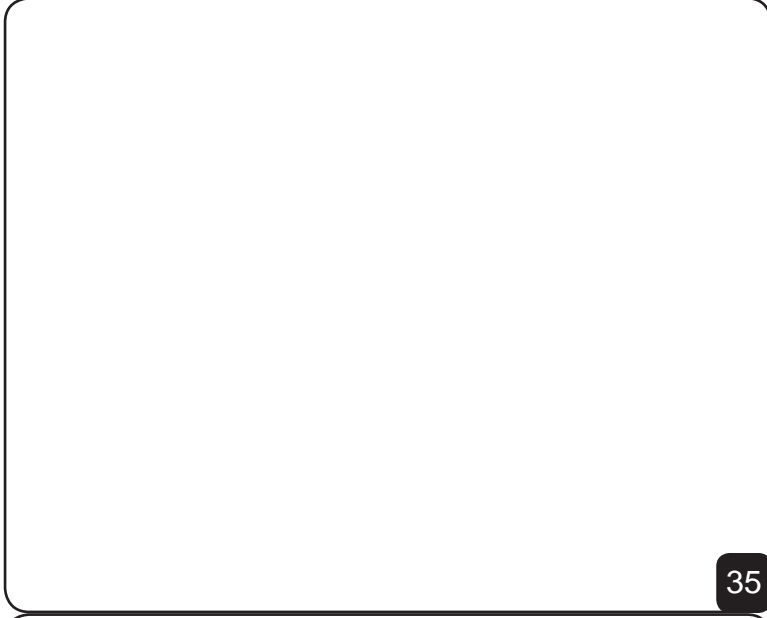

35

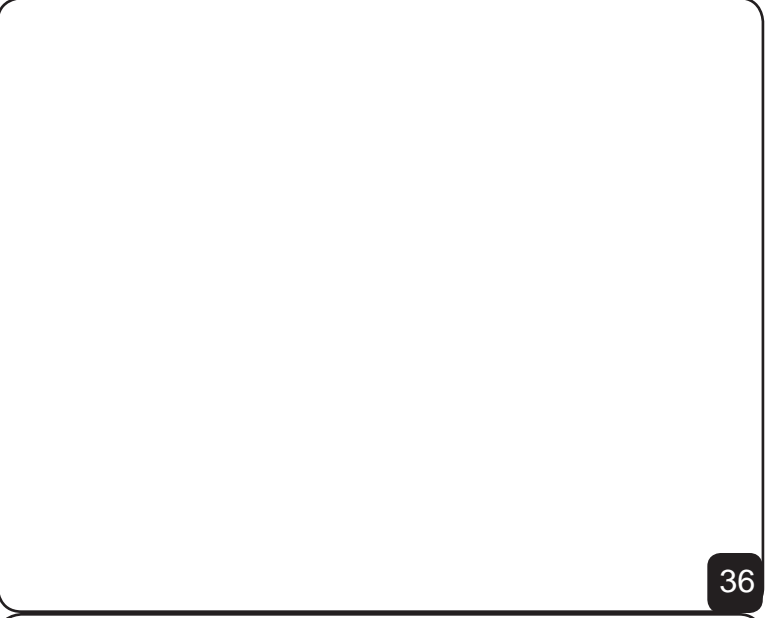

36

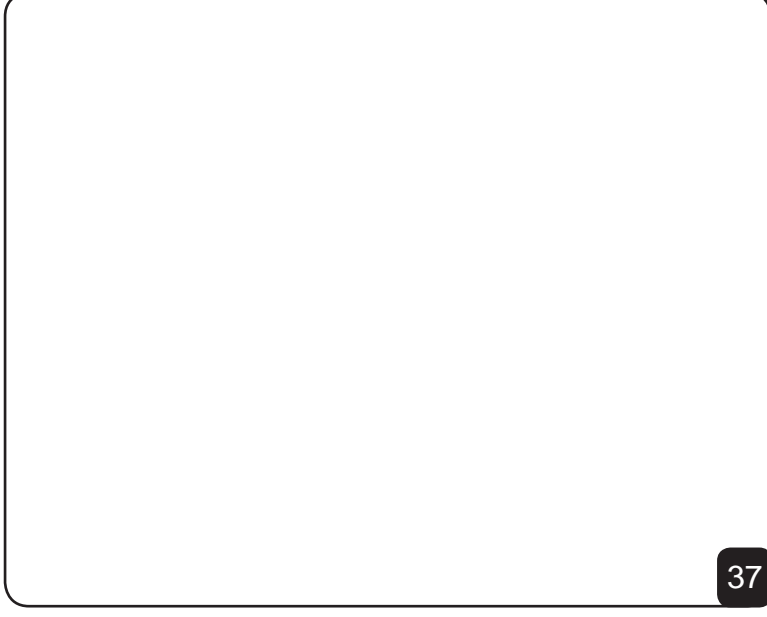

37

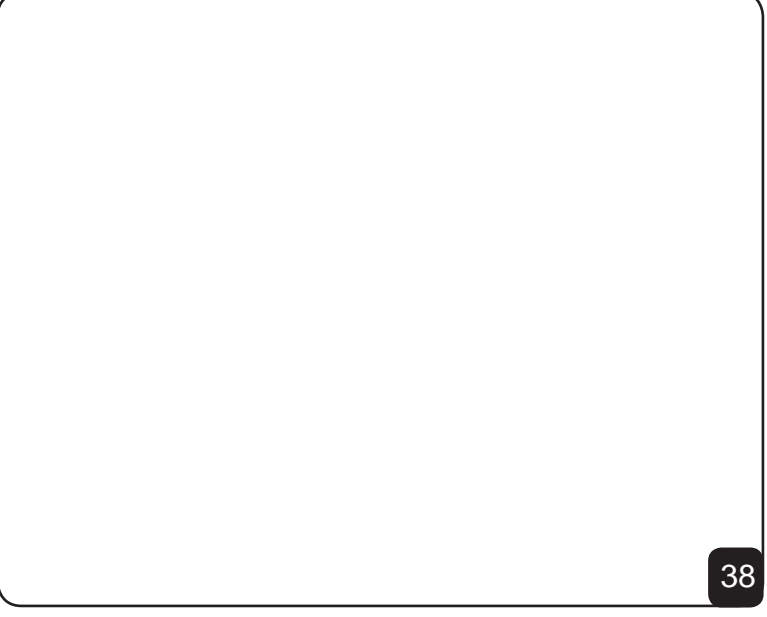

38

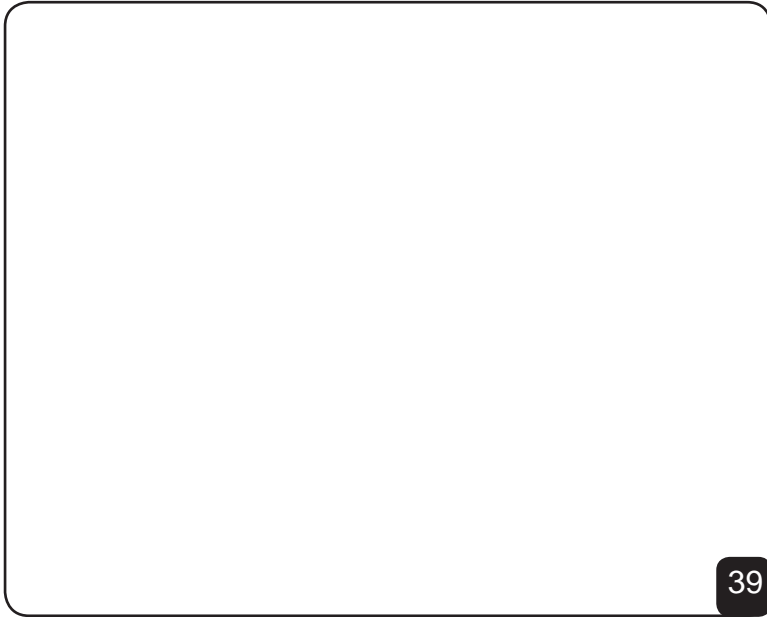

39

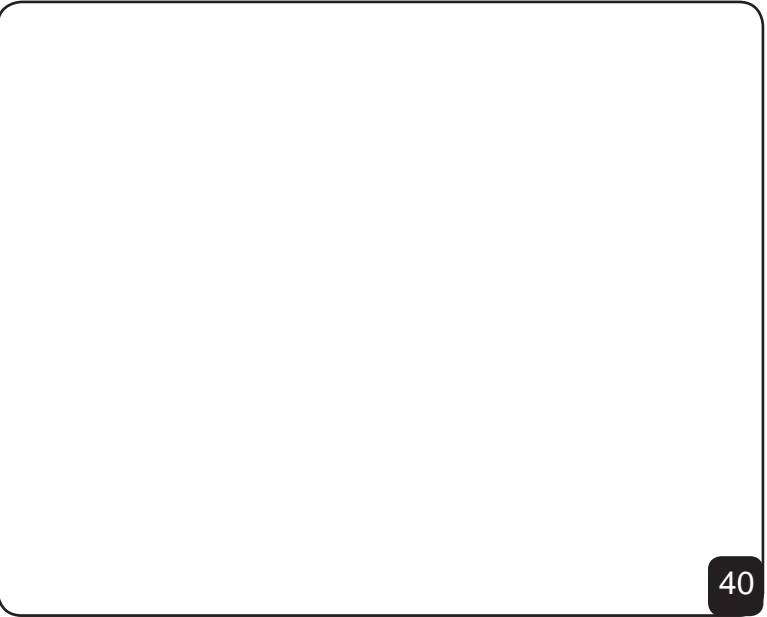

40

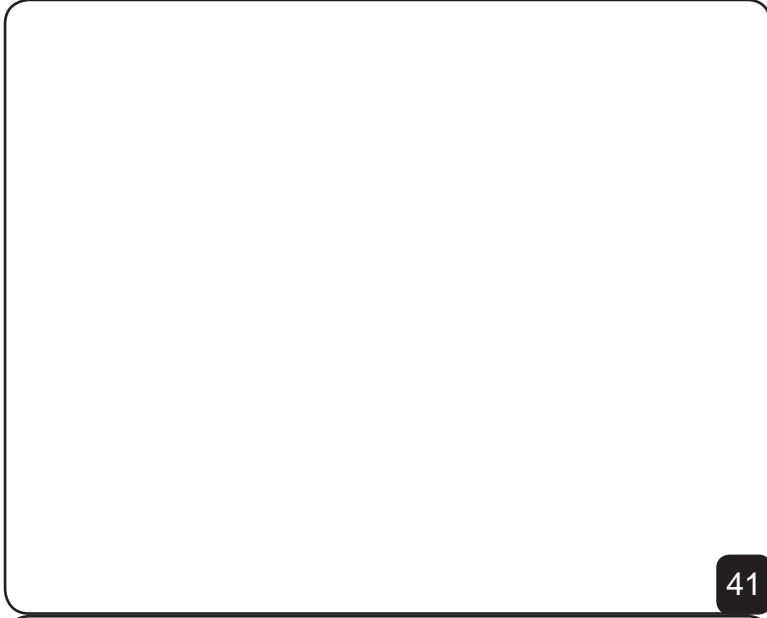

41



42



43



44

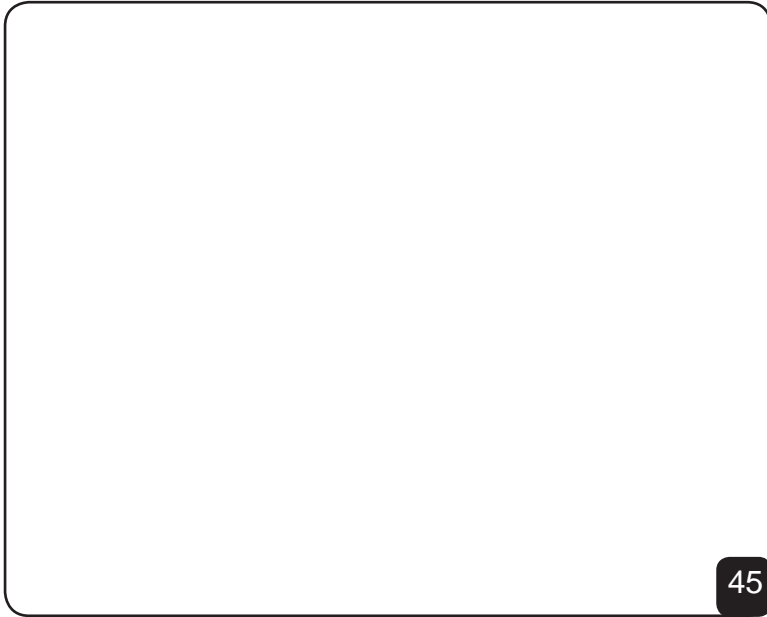

45

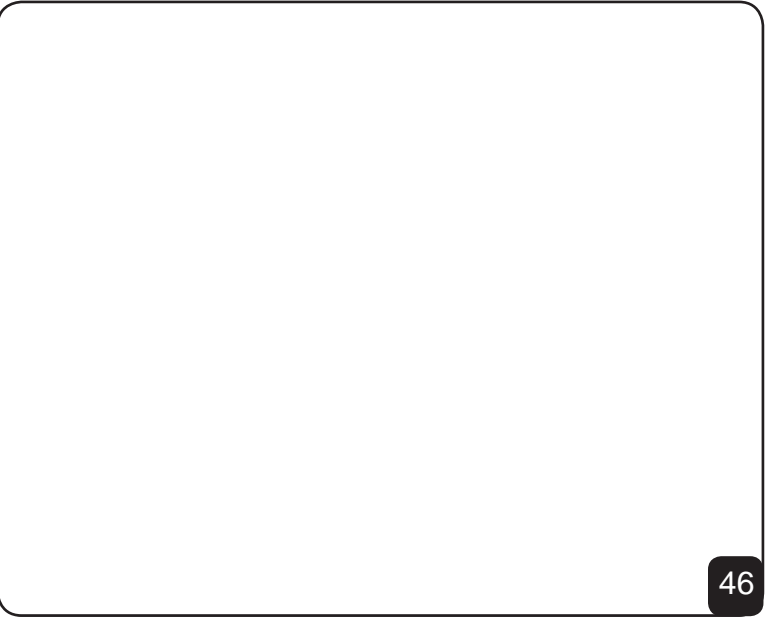

46

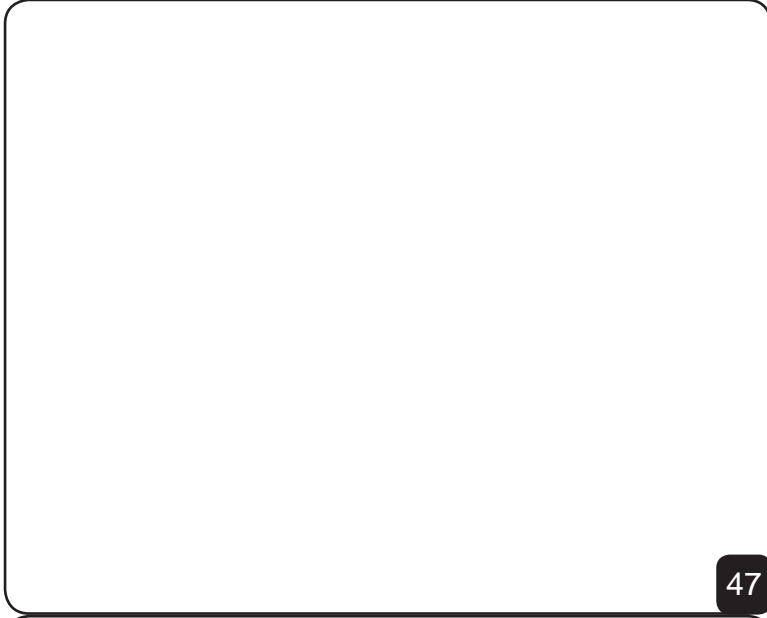

47

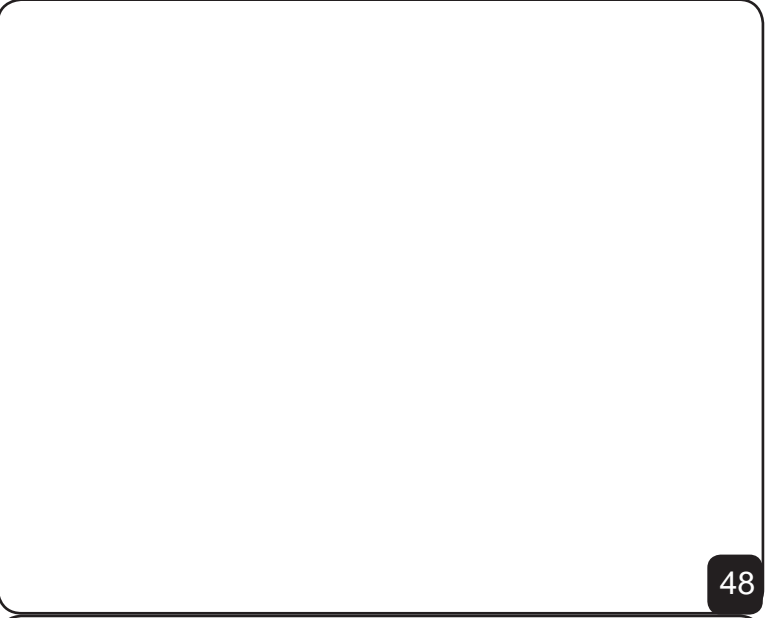

48

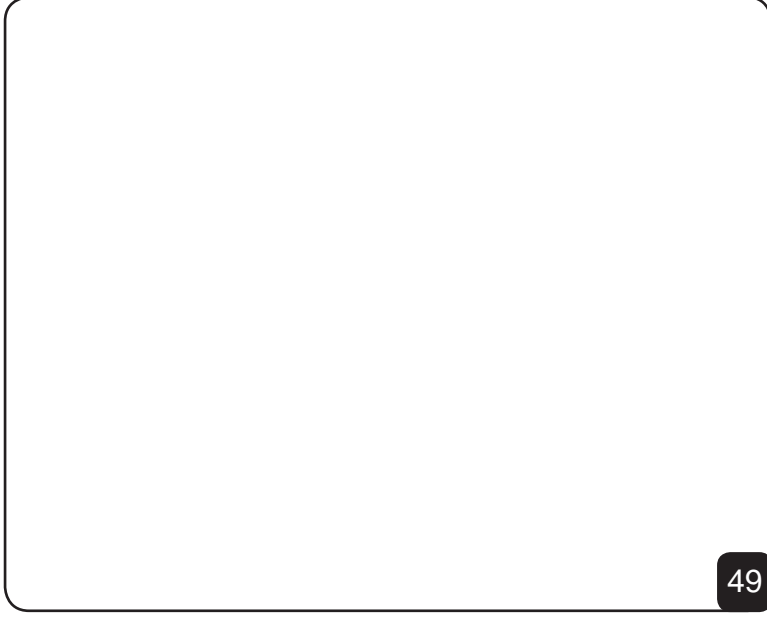

49



50

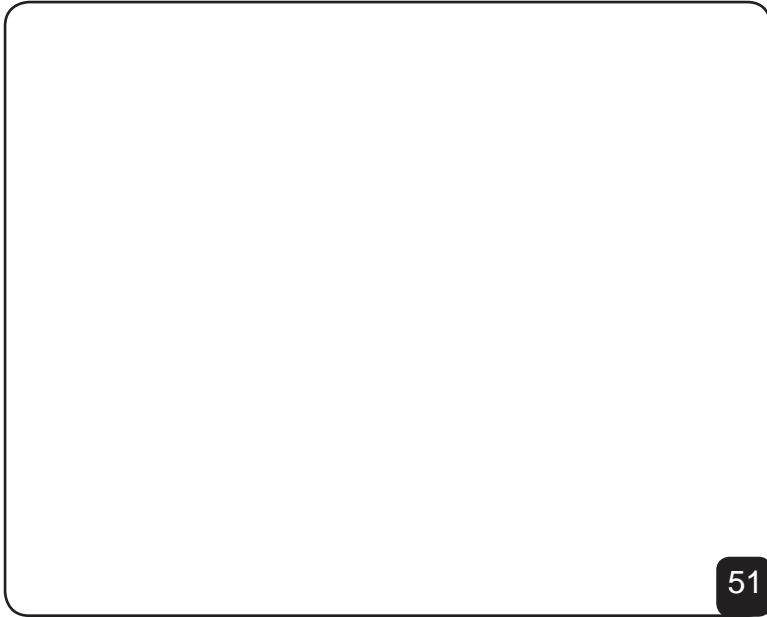

51

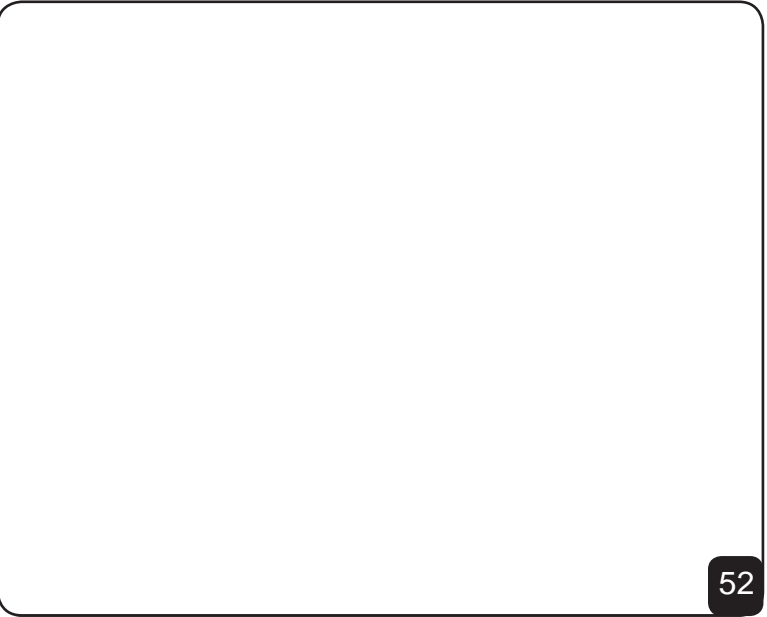

52

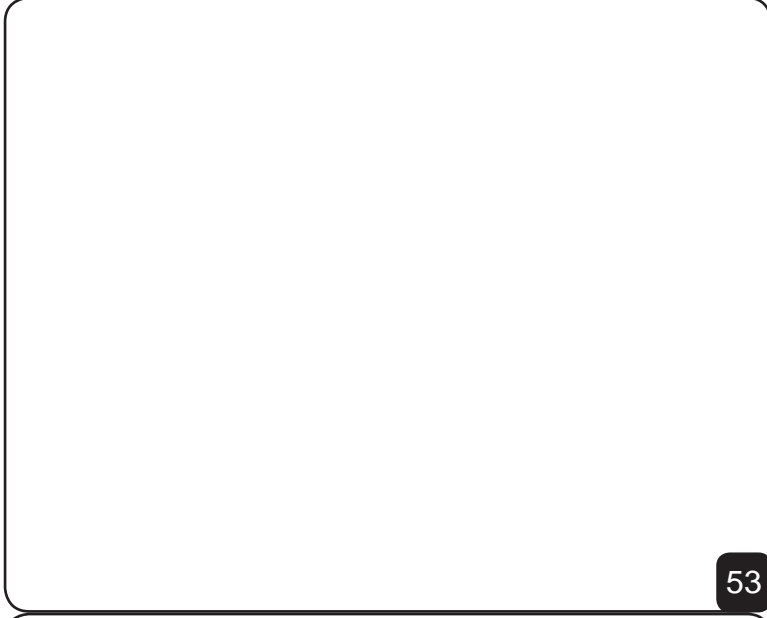

53

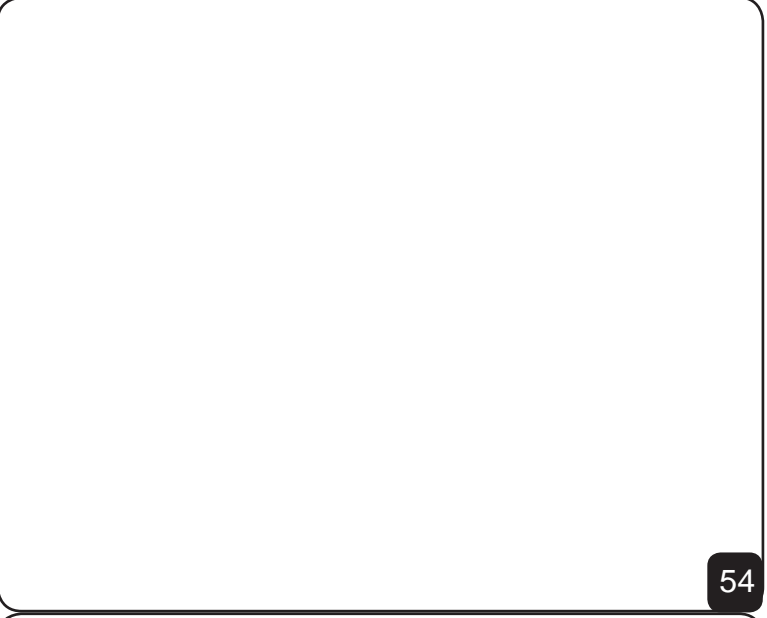

54

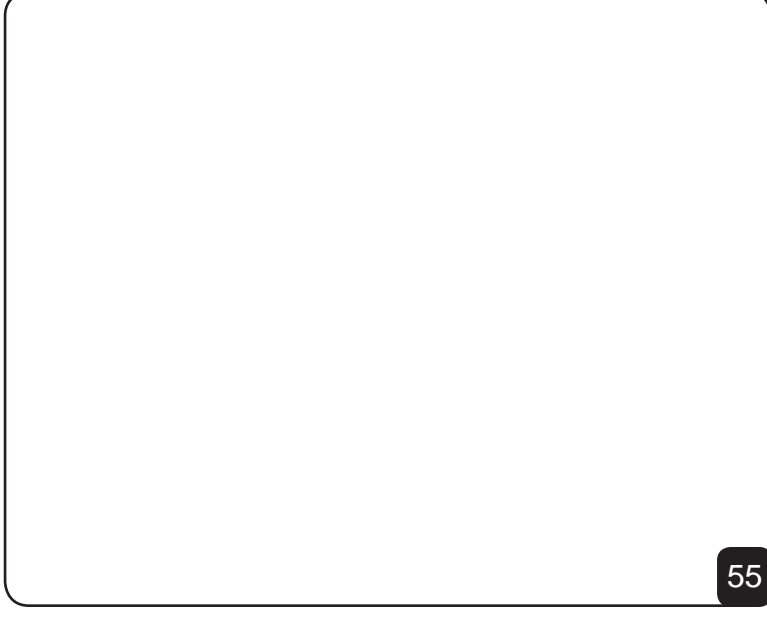

55

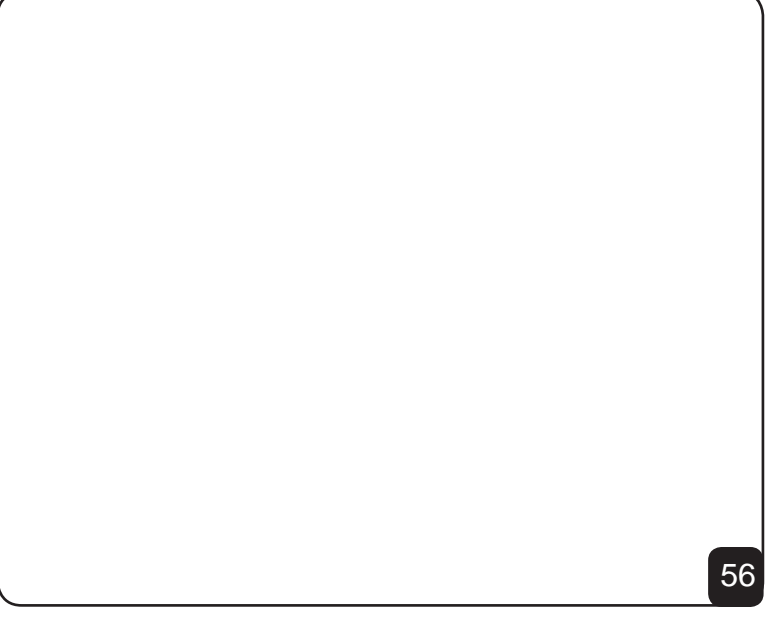

56



57



58

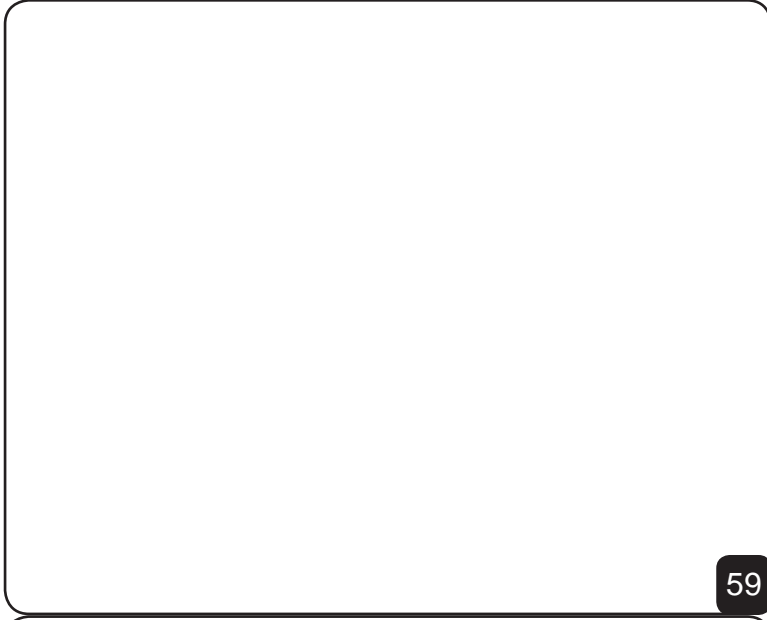

59

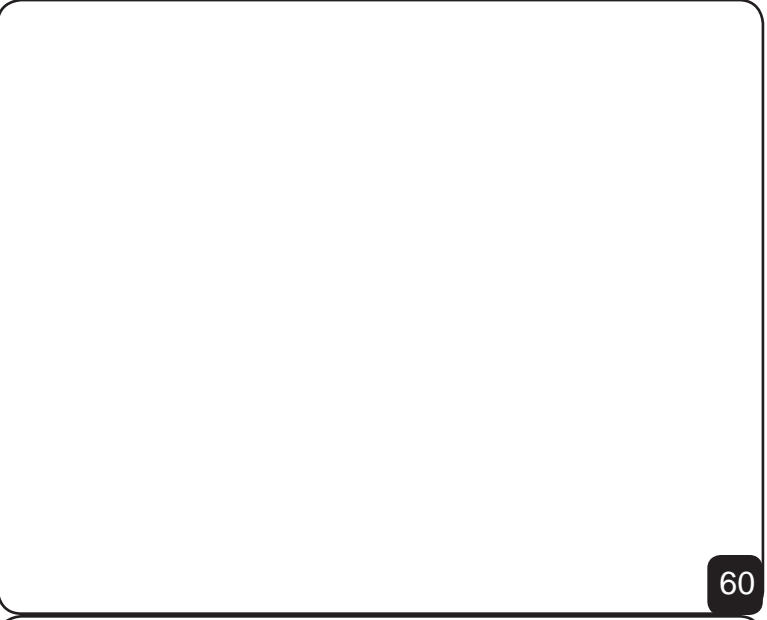

60

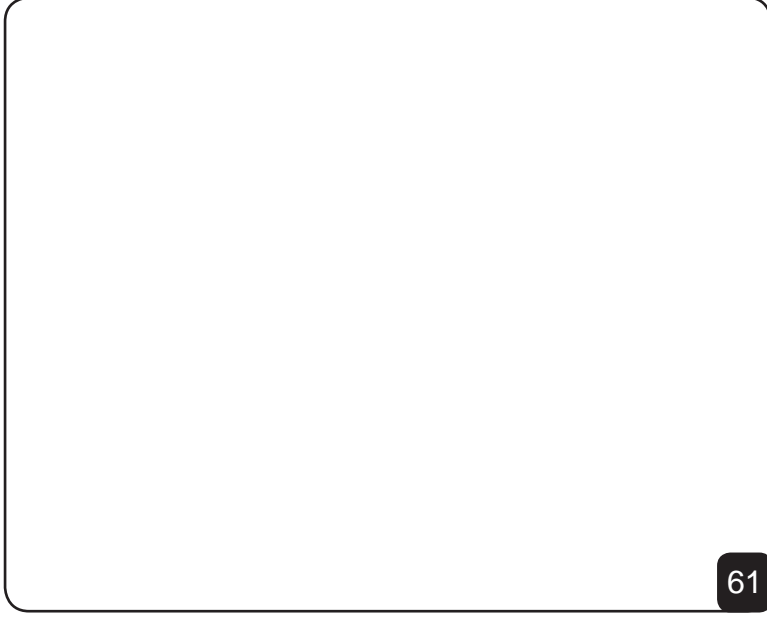

61



62