

# Bibeli fun Awon omode mu wa



Orun, Ile  
Olorun  
Lewa



Kọ nipasẹ: Edward Hughes

Alaworan nipasẹ: Lazarus  
Alastair Paterson

Ti a ẹe badọgba nipasẹ: Sarah S.

Ti tumọ nipasẹ: [www.christian-translation.com](http://www.christian-translation.com)

Ṣelọpọ nipasẹ: Bible for Children  
[www.M1914.org](http://www.M1914.org)

©2021 Bible for Children, Inc.

Iwe-aṣẹ: O ni ẹtọ lati daakọ tabi tẹ itan yii, niwọn igba ti o ko ta.



Nigbati Jesu wa laye o so fun awon omọ-ẹhin Re nipa Orun. O pe ni "Ile Baba mi", o so pe opolopo awon ibugbe nla wa nibe. Ile nla je ile nla, ẹlewa. Orun tobi o si lewa ju ile eyikeyi ti aye lo.

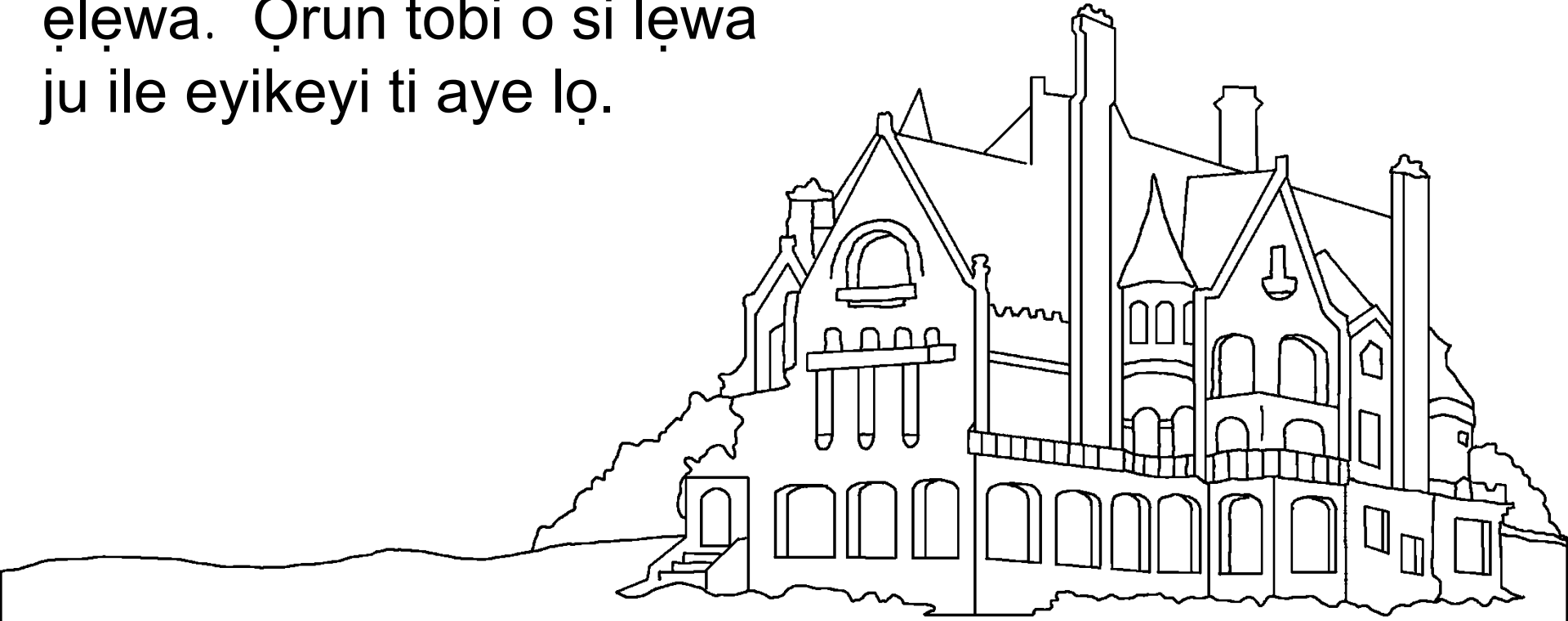

Jesu sọ pe, “Mo lọ lati pese aye silẹ fun ọ. Ati pe ti mo ba lọ seto aaye fun ọ, Emi yoo tun pada wa gba ọ si ara mi.” Jesu lọ si Ọrun, lehin O jinde kuro ninu oku. Lakoko ti awọn ọmọ-ẹhin Re nwo, a mu Jesu lọ, awọsanma si gba A kuro loju wọn.

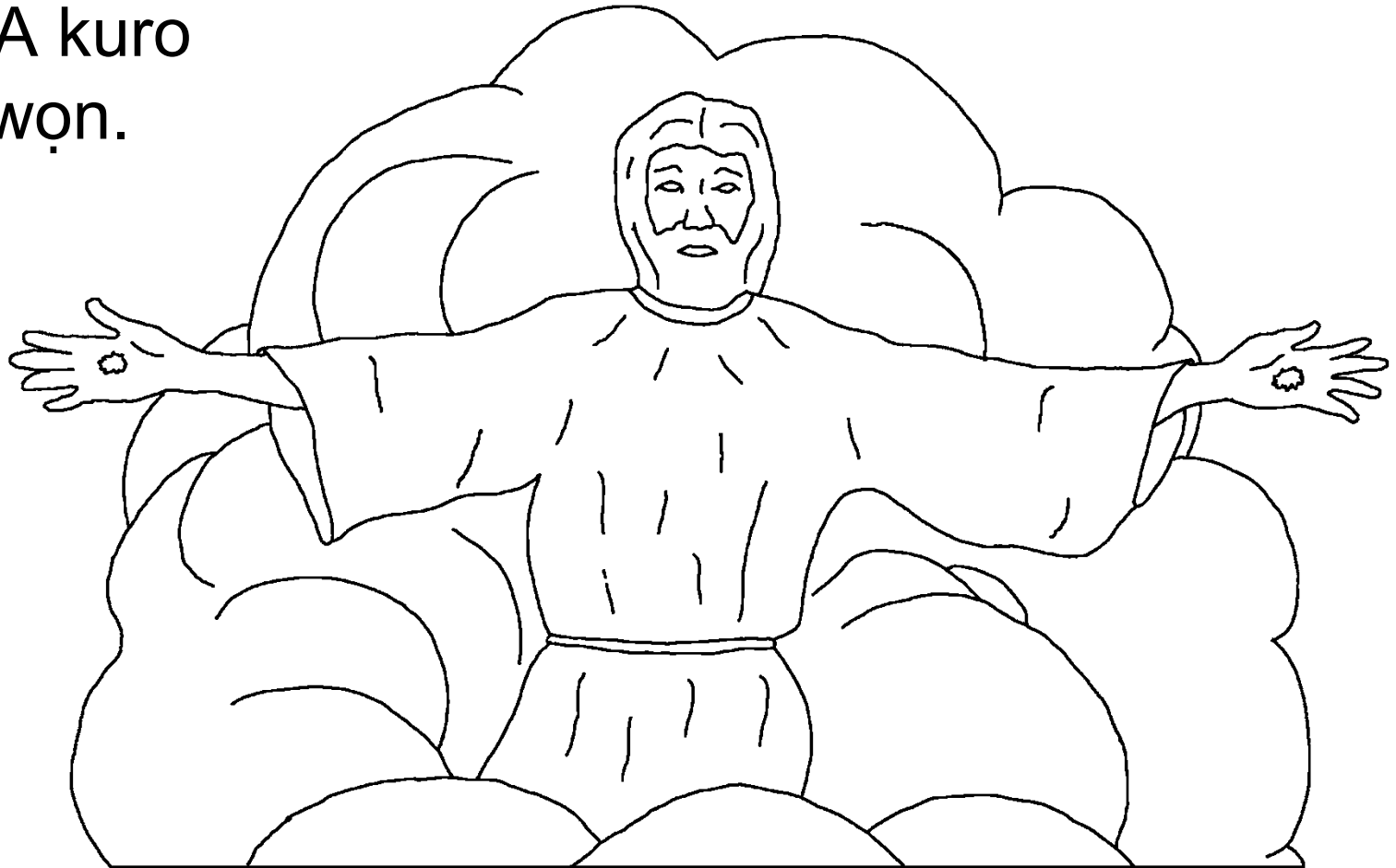

Lati igbanna, awon kristeni ti ranti ileri Jesu lati pada wa gba won. Jesu so pe Oun yoo pada wa lojiji, nigbati o kere ju ireti. Sugbon kini nipa awon kristeni ti o ku saaju ki O to de? Bibeli so pe won lo taara lati wa pelu Jesu. Lati wa ni ara ni lati wa pelu Oluwa.

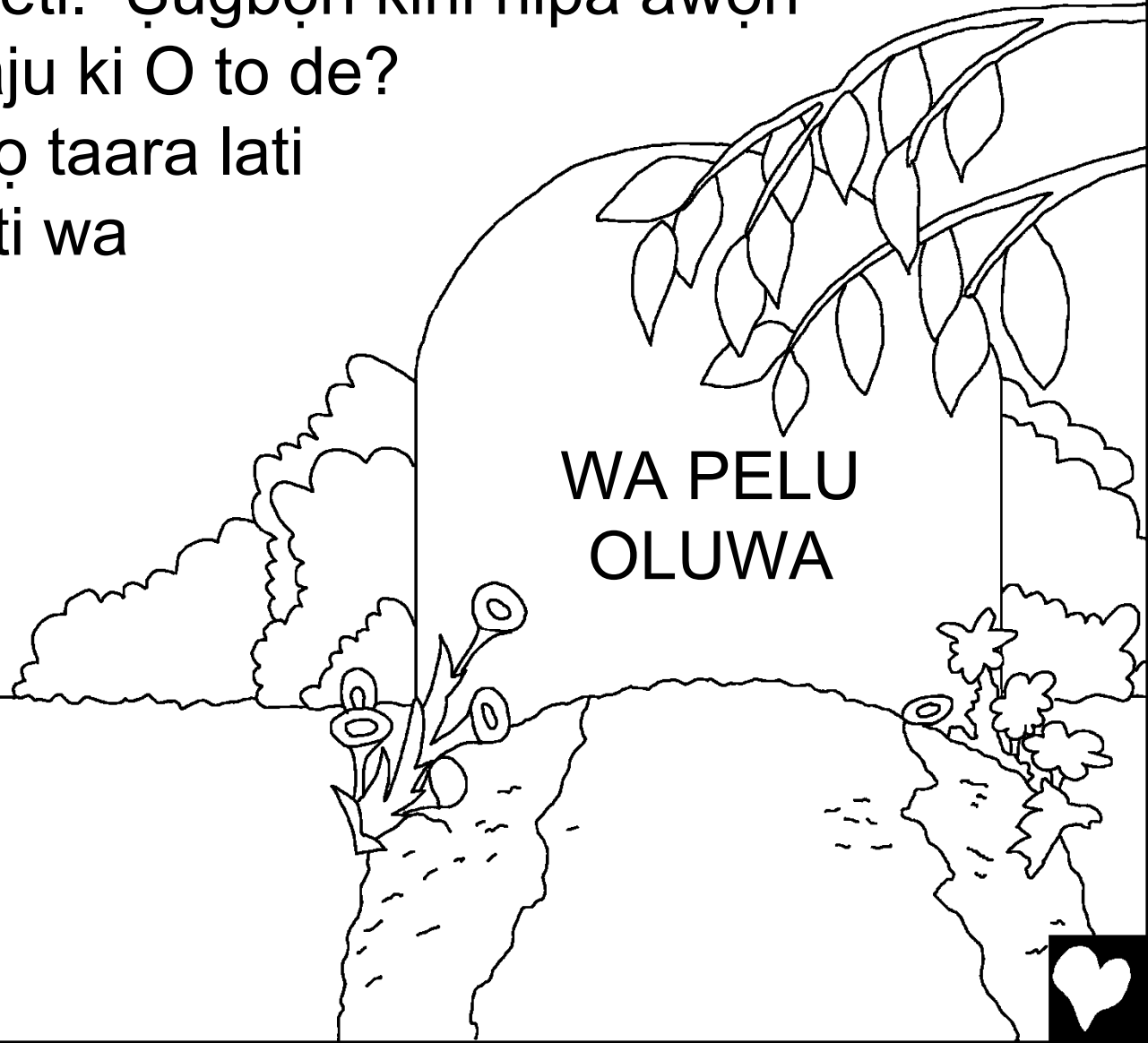

Ifihan, iwe ti o kẹhin ninu Bibeli, so fun wa bi Ọrun se je iyanu. Ohun iyanu julọ ni pe, ni ona pataki pupọ, Ọrun ni ile Ọlorun. Ọlorun wa nibikibi, sugbon ite Re wa ni Ọrun.

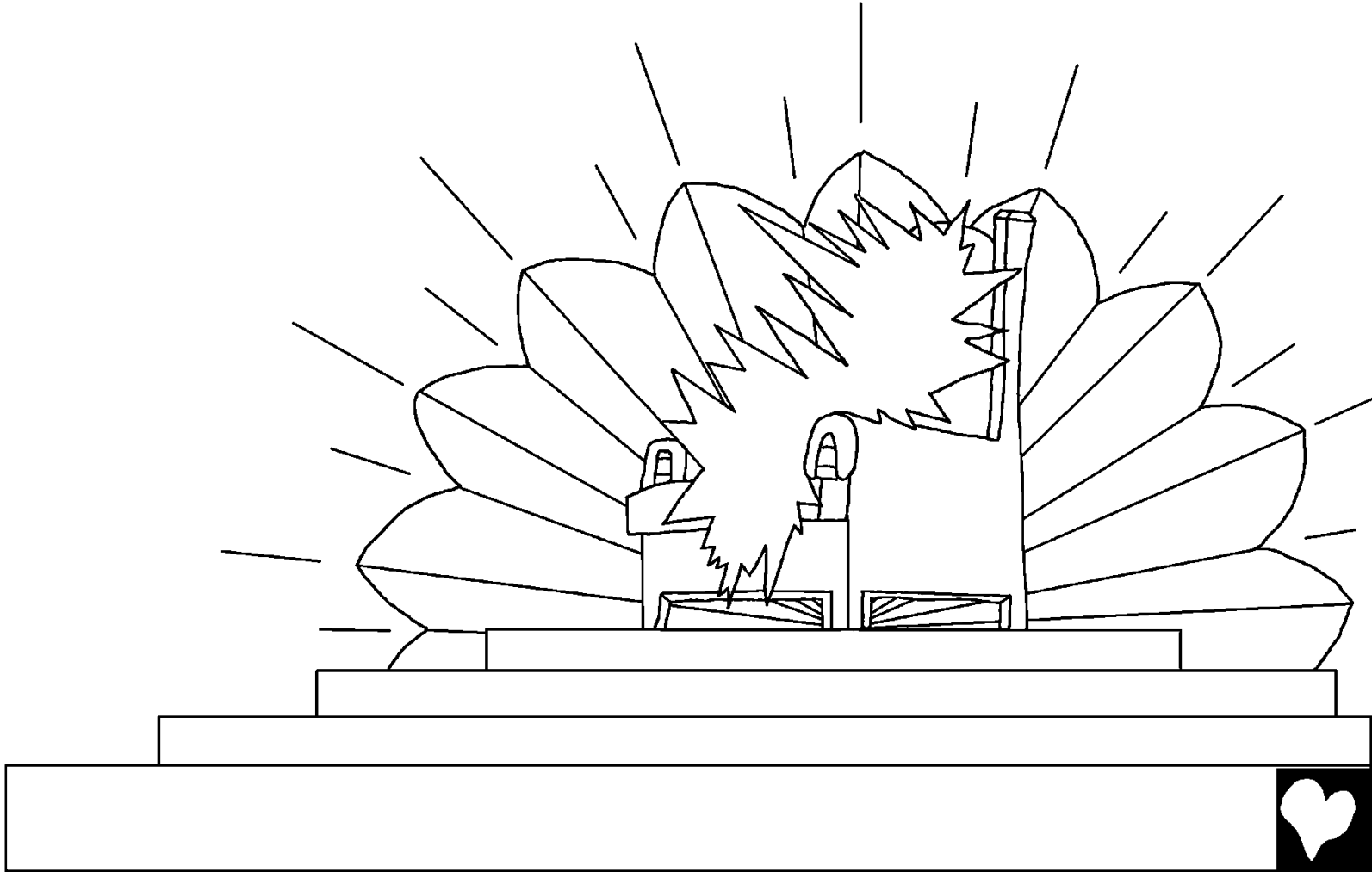

Awon angeli ati awon eda orun  
miiran sin Olurun ni Orun.  
Nitorina gbogbo awon eniyan  
Olurun ti o ti ku ti won ti lo si  
Orun. Won korin awon orin  
pataki ti iyin si Olurun.

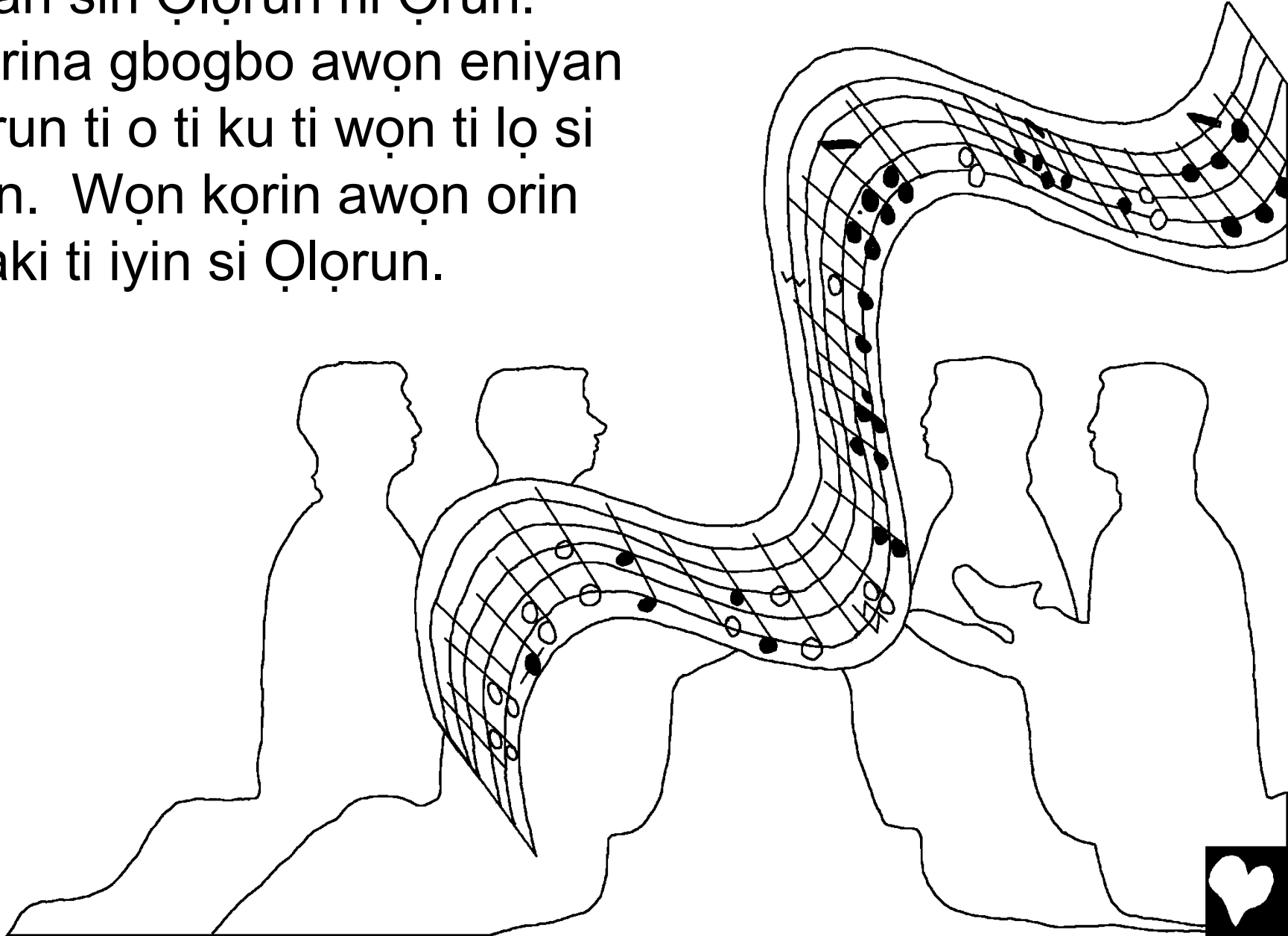

Eyi ni diẹ ninu awọn ọrọ lati inu orin kan ti wọn kọ:  
O TI ŞE TI O TI RỌ RĘ SI ỌLỌRUN NIPA ẸJẸ  
RĘ KURO NIPA GBOGBO ẸNI  
ATI ORILE-EDE TI O SI FI WA  
ŞE AWỌN ỌBA ATI ALUWỌ  
SI ỌLỌRUN WA. (Osọ. 5: 9)

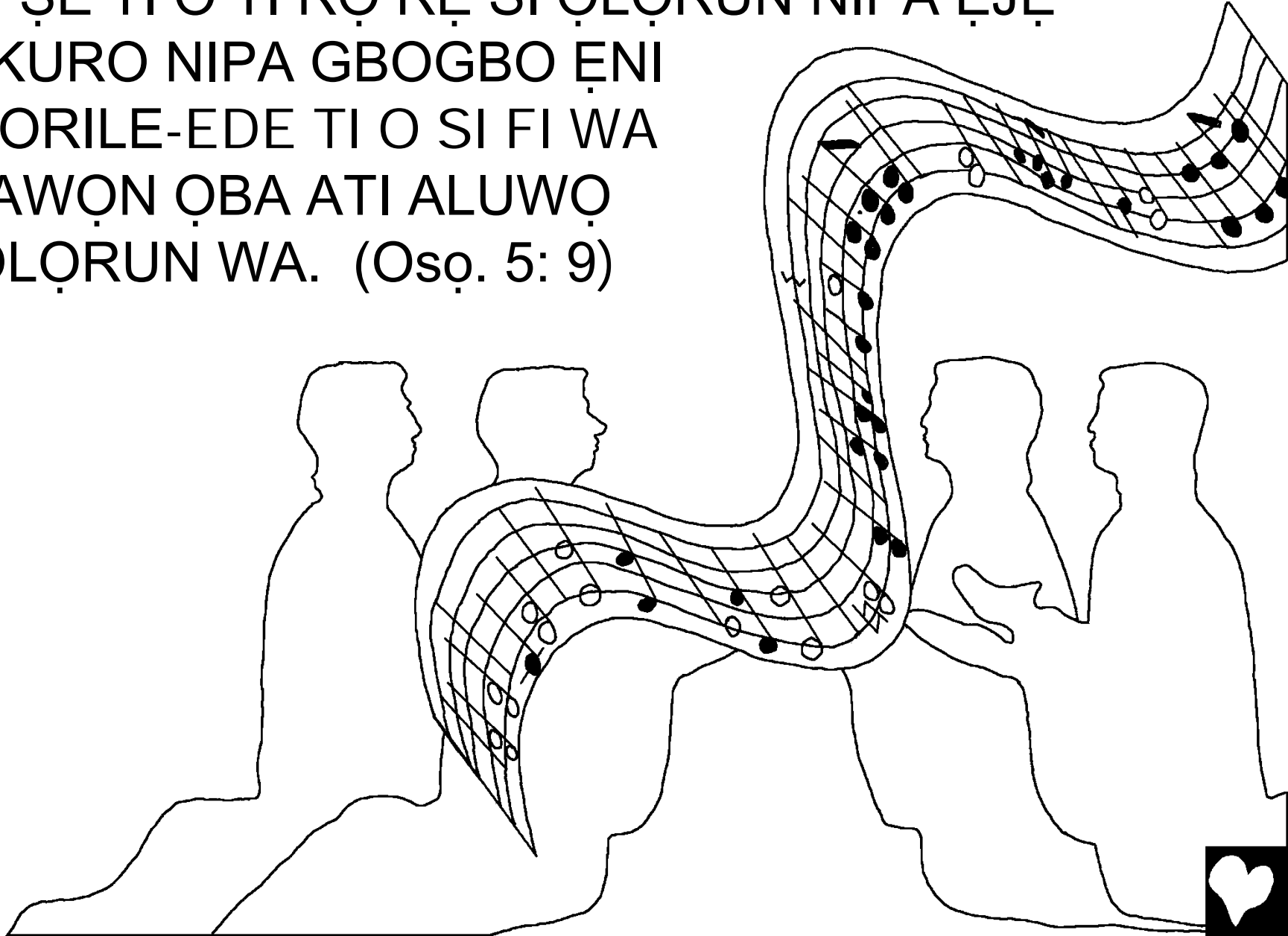



Awon oju-iwe ti o kehin gan-an ti Bibeli sapejuwe Orun bi "Jerusalemu Tuntun". O tobi pupo, o tobi pupo, pelu ogiri giga ni ita. Odi naa je okuta okuta Jasper, o mo bi kristali. Awon ohun iyebiye ati awon okuta iyebiye bo ipile ti ogiri, dan pelu awon awo elewa. Olukuluku awon enubode ilu ni a fi parili nla kan se!

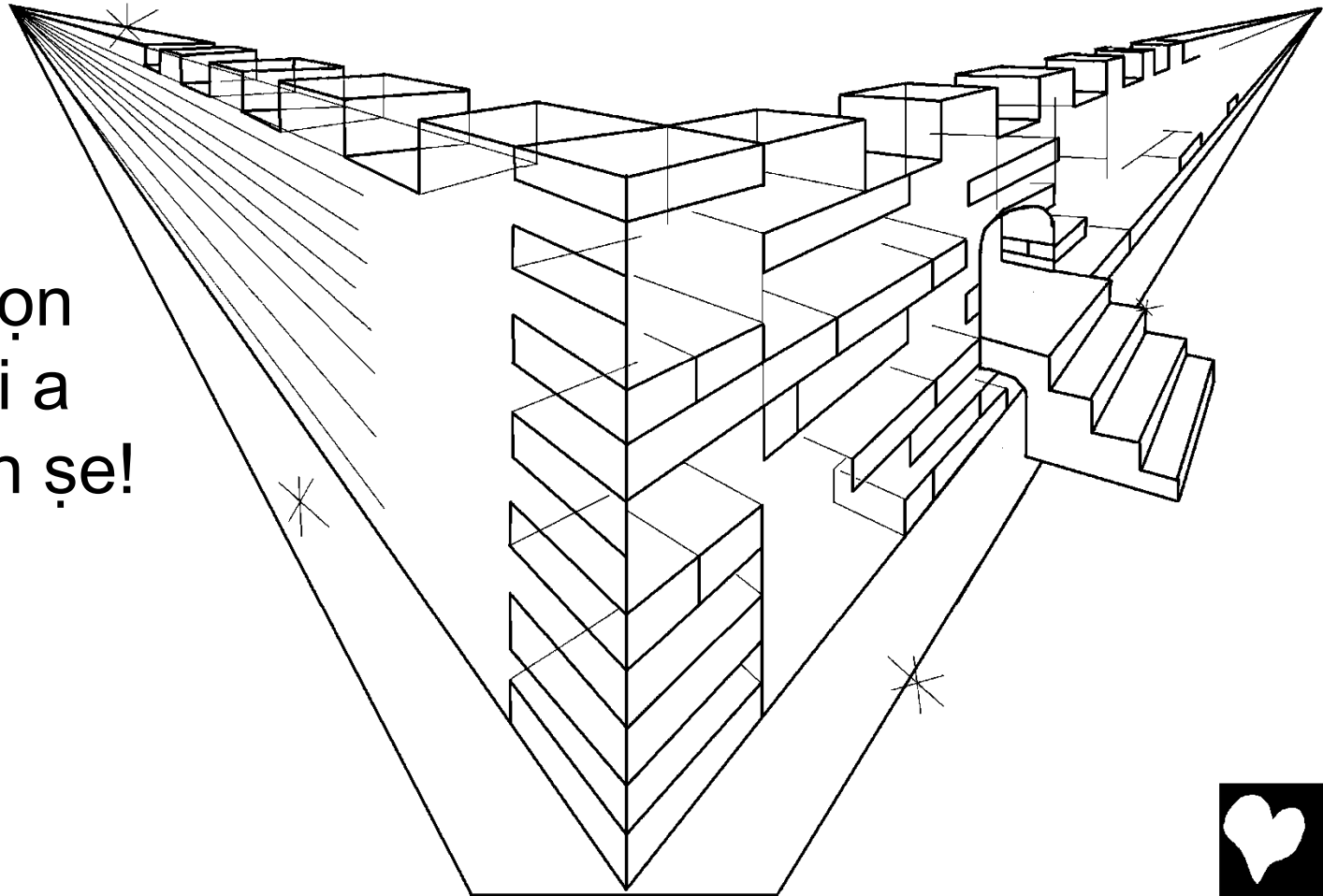

Awon ilekun pearly nla wonyen ko tii pa. Je ki a  
wole ki a wo yika ... WOW! Orun paapaa lewa  
julọ inu. Ti wura ni a se ilu naa, bi gilasi didan.  
Paapaa ita ni a  
fi wura se.

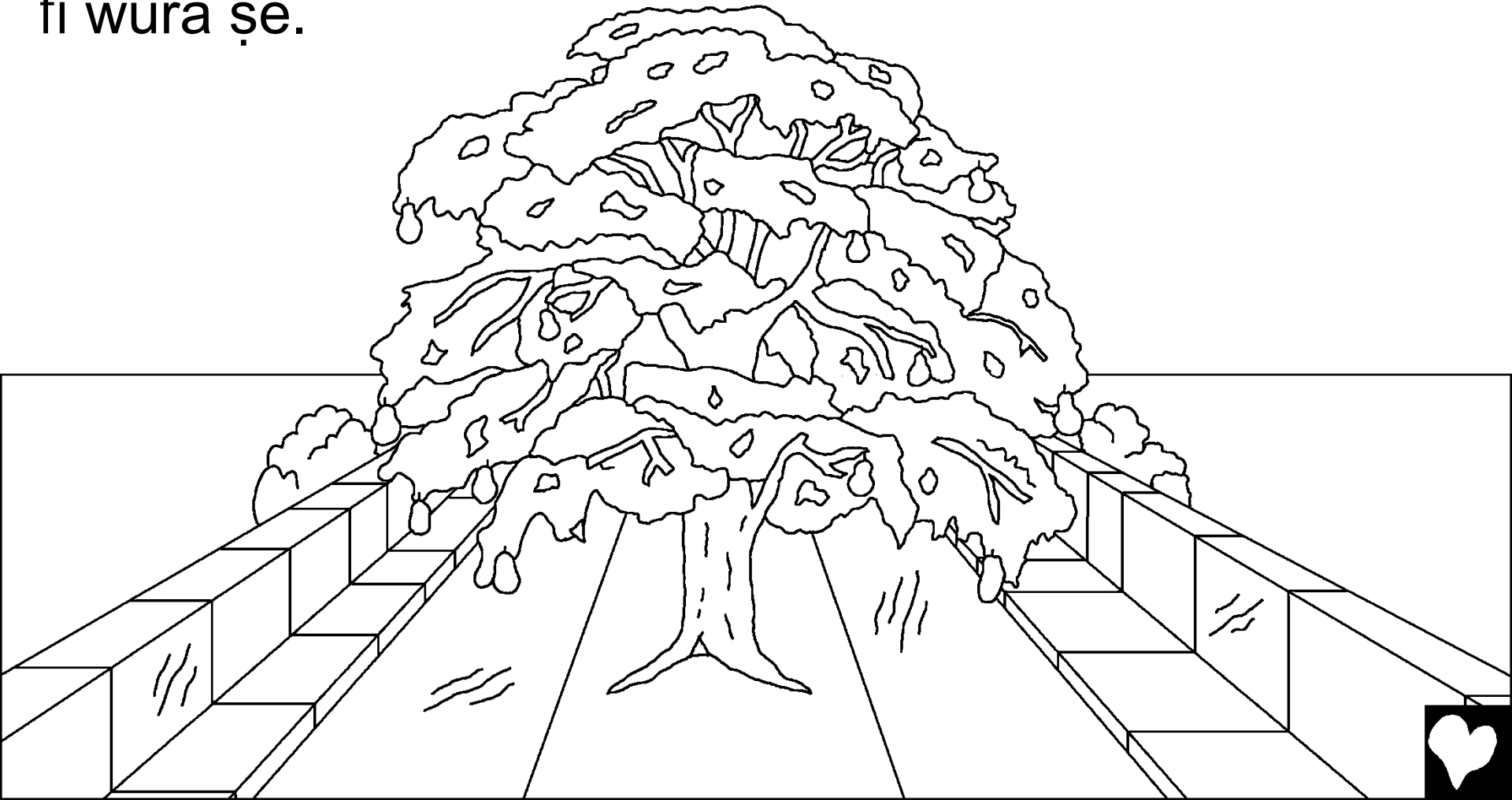

Odò rírewà kan, tí ó mọ kedere láti inú omi iyè n ẹ̀sàn  
láti orí ìtẹ̀ Ọ̀lorun. Ni ẹ̀gbẹ̀ mejeeji ti odo ni igi ti iye,  
eyiti a kọkọ rii ni Ọ̀gba Edeni. Igi yii jẹ pataki pupọ. O  
ni eso orişirişi mejila, iru orişirişi ni oşu kọkọkan. Ati  
awọn ewe igi iye ni fun imularada awọn orişẹ-ede.

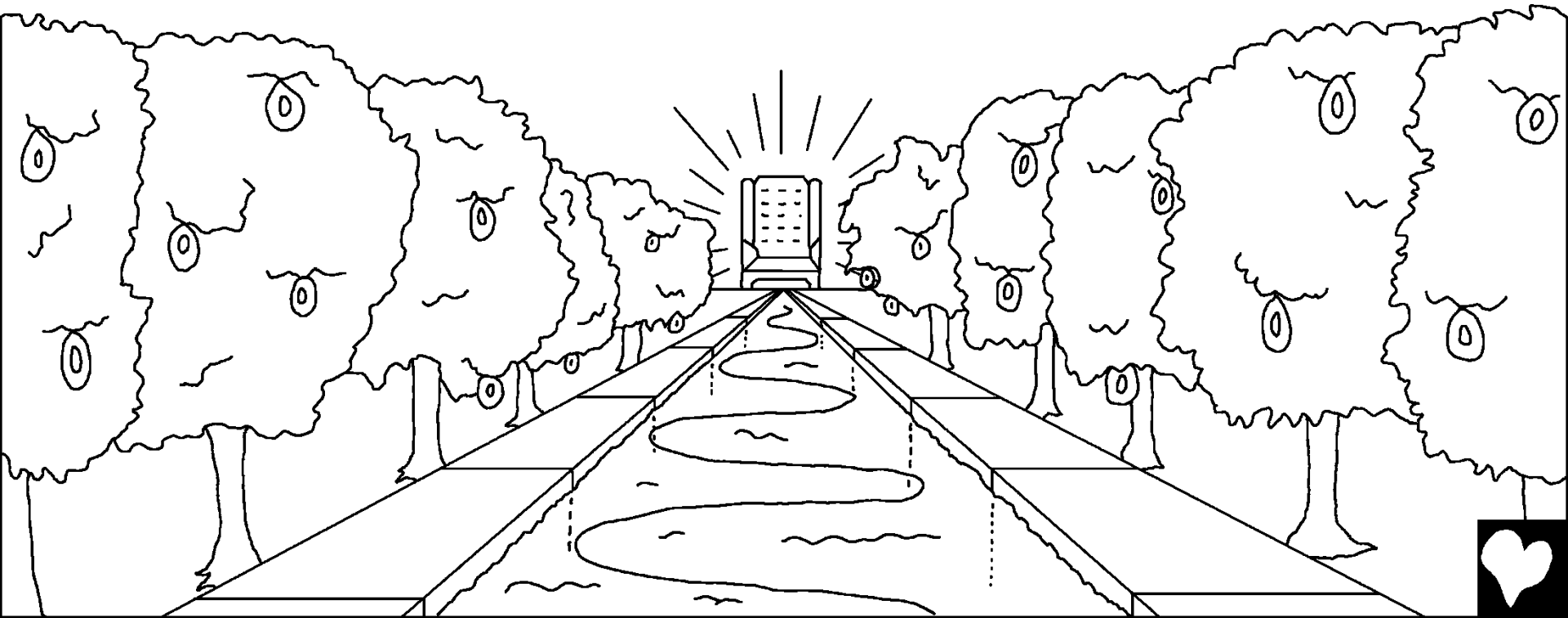

Ọrun ko nilo oorun tabi oşupa fun imọlẹ. Owngo  
Ọlorun funraare kun fun peju imólẹ agbayanu. Ko si  
alẹ kankan nibe.

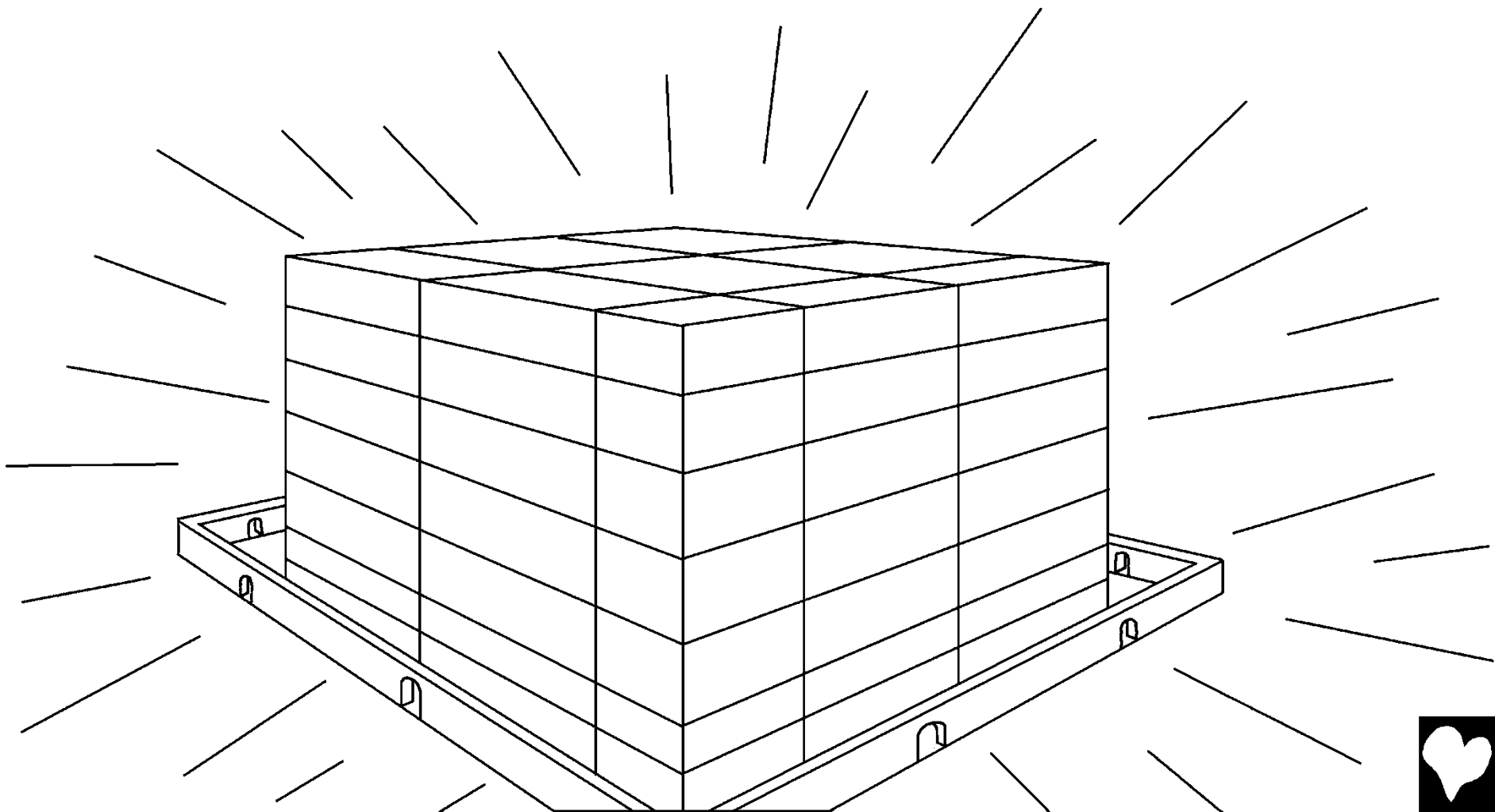

Paapaa awon eranko ni Orun yato. Gbogbo won je tame ati ore. Ikooko ati odo-agutan jeun lori koriko papo. Paapaa awon kiniun alagbara n je koriko bi akomalu. Oluwa so pe, "Won ki yoo se ipalara tabi parun ni gbogbo oke mimo mi."



Bi a  e nwo yika, a  e akiyesi pe awon nkan wa ti o padanu lati Orun. Ko si oro ibinu ti a gbo rara. Medepope ma to avunho kavi yin sejannabino gba. Ko si awon titipa lori awon ilekun, nitori ko si awon ole ni Orun. Ko si awon opuro, awon apaniyan, awon oso, tabi awon eniyan buruku miiran. Ko si ese eyikeyi iru ni Orun.

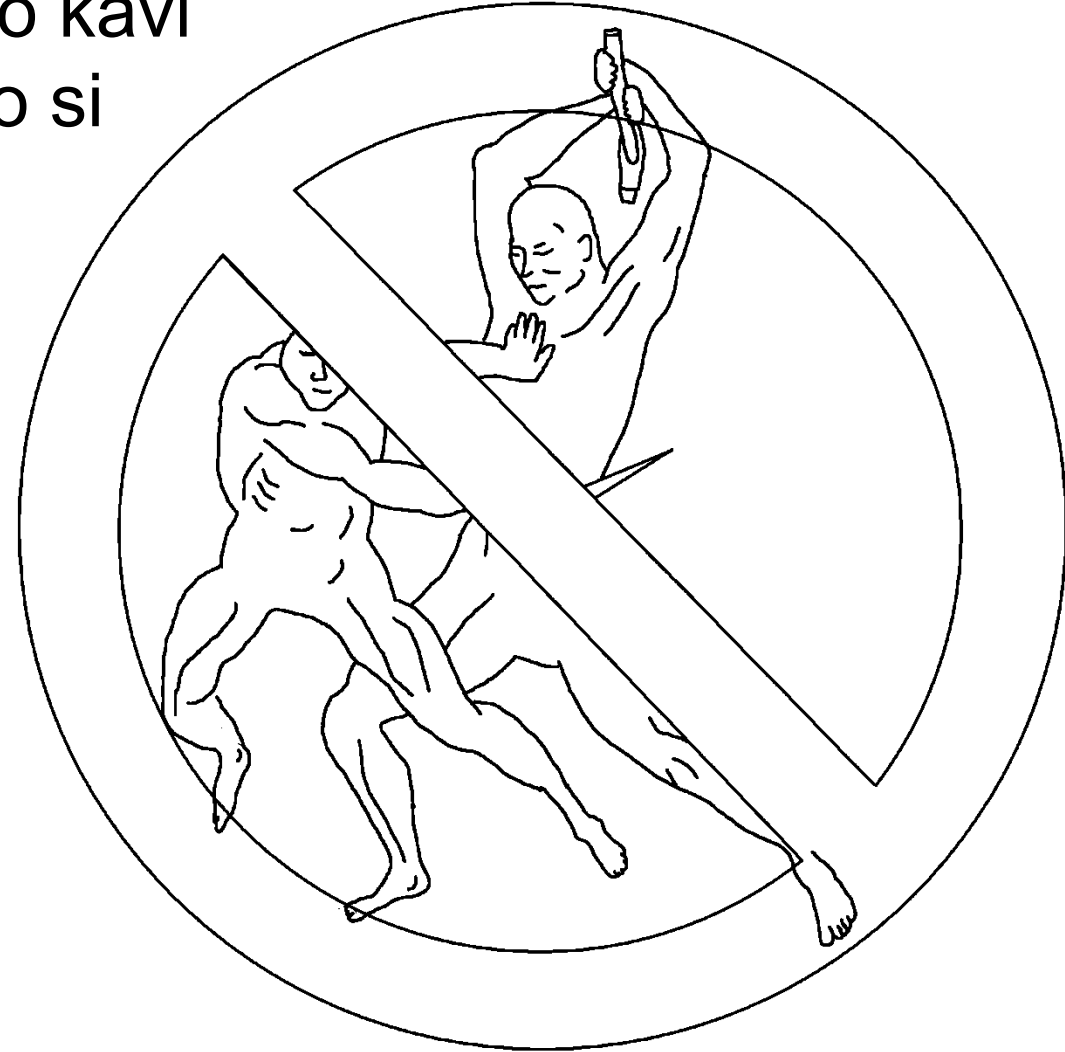

Ni Ọrun pẹlu Ọlorun ko si omije mo. Nigbakuran, awon eniyan Ọlorun kigbe nitori awon ibanuje nla ni igbesi aye yii. Ni Ọrun, Ọlorun yoo nu gbogbo omije nu.



There is no death in Heaven, either. God's people will be forever with the Lord. There is no more sorrow, no more crying, no more pain. No sickness, no parting, no funerals.

Everyone in Heaven is happy forever with God.





Ko si iku ni Ọrun, boya. Awon eniyan Ọlorun yoo wa lailai pelu Oluwa. Ko si ibanuje mo, ko si si ekun mo, ko si irora mo. Ko si aisan, ko si ipinya, ko si isinku. Gbogbo eniyan ni Ọrun ni idunnu lailai pelu Ọlorun. Ninu ọrun iwe wa ti a pe ni Iwe Ọdọ-Agutan ti iye. O kun fun oruko awon eniyan. Nje o mo awon oruko ti won ko si nibe? Gbogbo eniyan ti o gbekele Jesu.

Se oruko re wa nibe?

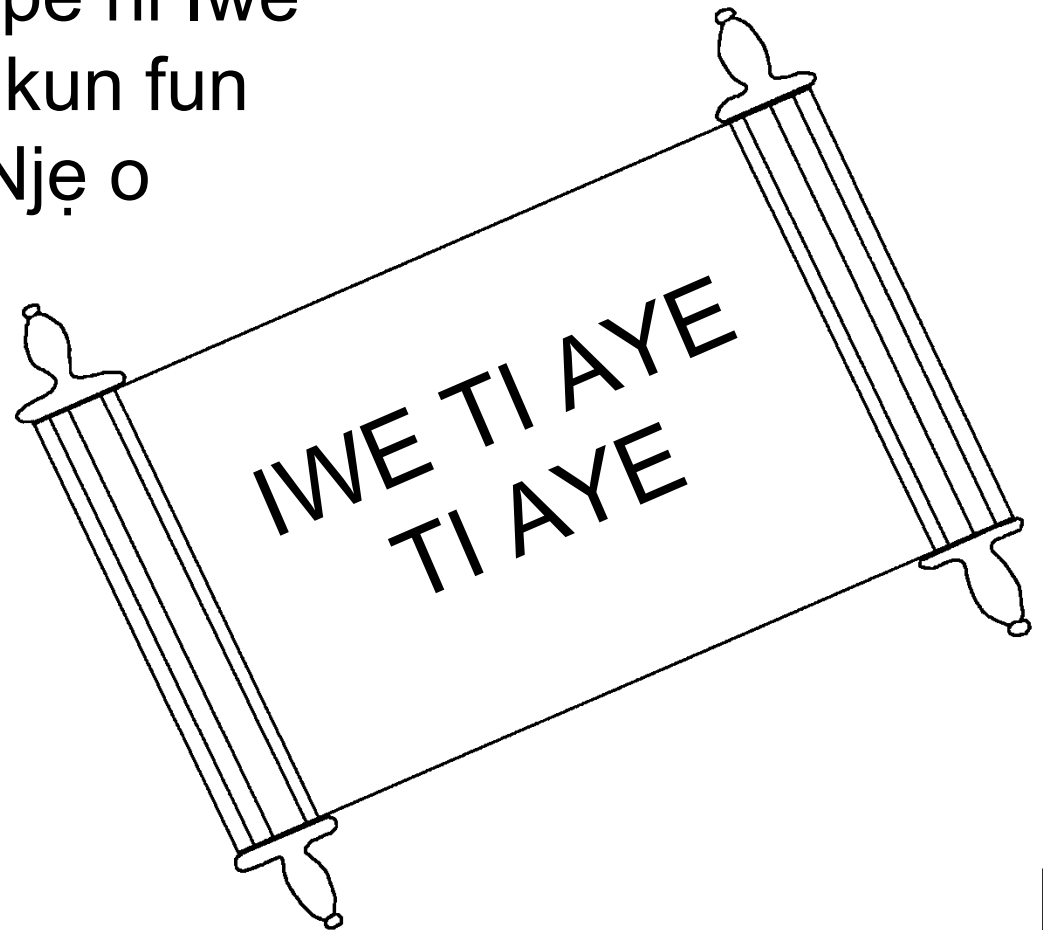

Awọn ọrọ ikehin ti Bibeli nipa Ọrun je pipe si iyanu.  
“Ati pe Ẹmi ati iyawo so pe, ‘Wá!’ Ati ki eniti o gbo ki  
o wi pe ‘Wá!’ Ati ki eniti ongbe ngbe ki o wa. Ati  
eniken ti o ba fe, ki o gba omi iye lofe.”



Ọrun, Ile Ọlorun Lẹwa

Itan kan lati inu Ọrọ Ọlorun, Bibeli,

ti wa ni ri ni

Johanu 14; 2 Korinti 5;

Ifihan 4, 21, 22

“Ẹnu awọn Ọrọ Rẹ n fun ni imọlẹ.”

Orin Dafidi 119:130



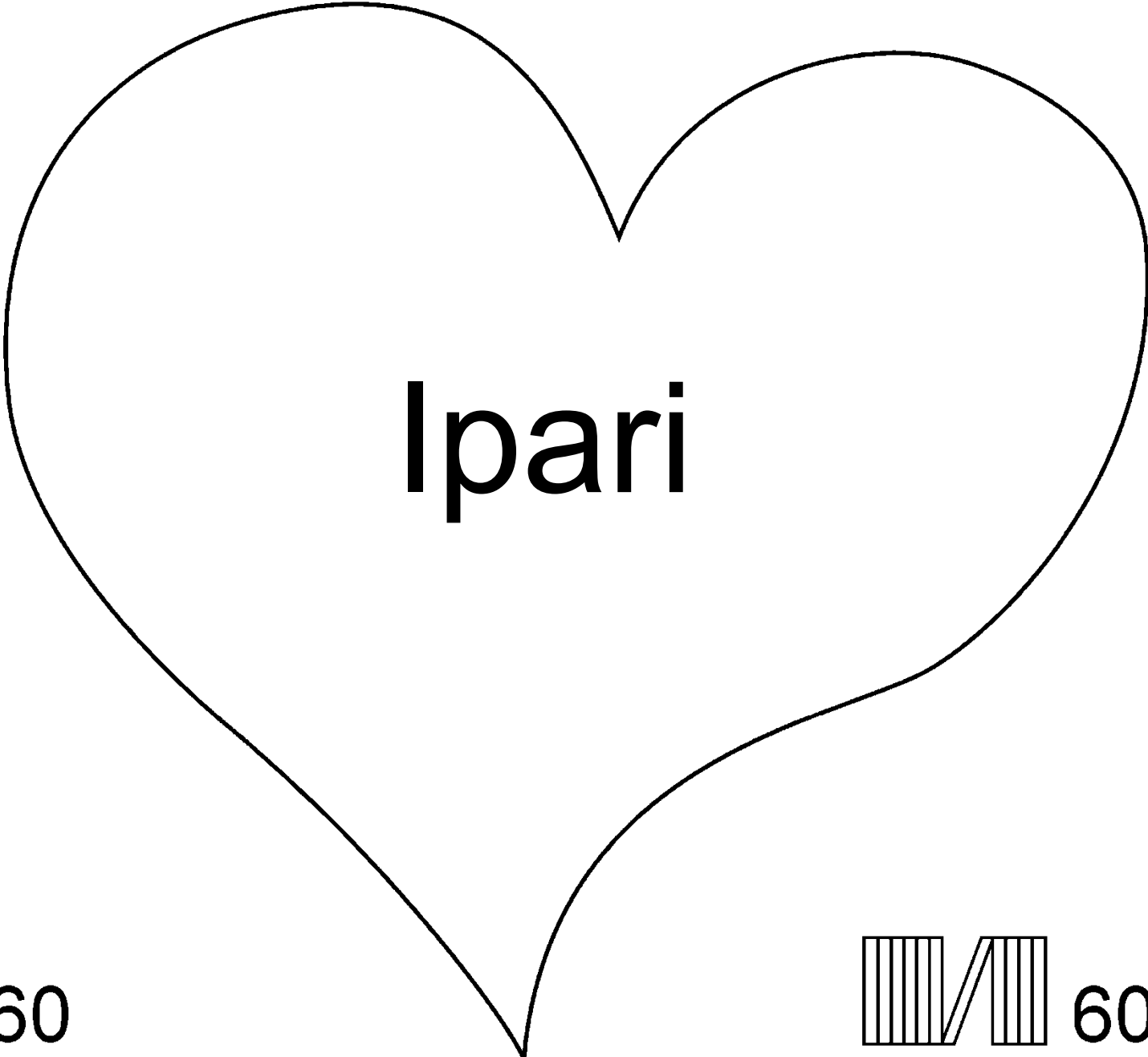

Ipari

| 60

||||| 60



Itan Bibeli yii sọ fun wa nipa Ọlọrun  
iyalẹnu wa ti o ẹ wa ati ẹniti o fẹ ki o mọ Ọ.

Ọlọrun mọ pe a ti ẹ awọn ohun buburu, eyiti O pe ni  
ẹẹ. Ijiya fun ẹẹ ni iku, şugbọn Ọlọrun fẹran rẹ pupọ O ran  
Ọmọkunrin kanşoşo Rẹ, Jesu, lati ku lori Agbelebu kan ati lati  
jiya fun awọn ẹẹ rẹ. Lẹhinna Jesu pada wa si aye o si lọ si ile  
rẹ si Ọrun! Ti o ba gbagbọ ninu Jesu ki o beere lọwọ Rẹ lati  
dariji awọn ẹẹ rẹ, Oun yoo ẹ! Oun yoo wa gbe inu  
rẹ ni bayi, ati pe iwọ yoo wa pẹlu Rẹ lailai.

Ti o ba gbagbọ pe eyi ni otitọ, sọ eyi fun Ọlọhun:  
Olufe Jesu, Mo gbagbọ pe lwọ ni Ọlọrun, o si di eniyan lati  
ku fun ẹẹ mi, ati nisisiyi O tun wa laaye. Jọwọ wa si igbesi  
aye mi ki o dariji awọn ẹẹ mi, ki n le ni igbesi aye tuntun ni  
bayi, ati pe ojo kan lọ lati wa pẹlu Rẹ lailai. Ran mi lọwọ  
lati gbọràn si Rẹ ati lati gbe fun Rẹ bi omọ Rẹ. Amin.

Ka Bibeli ki o ba Ọlọrun sọrọ ni gbogbo ojo! Johannu 3:16

