

Deftere Bikkon
Don sappina

Samuyila-
Biñngel Gorko
Jaggoowo Allah



Windowo: Edward Hughes

**Didowo: Janie Forest
Alastair Paterson**

Mo'inowo: Lyn Doerksen

Lornowo: The Bible Society of Nigeria

**Wanginowo: Bible for Children
www.M1914.org**

©2024 Bible for Children, Inc.

**Jarfuye: A don mari jarfu windugo mala wurtinugo tariya
ndu nder masin, to na je sippugo.**



Hanna laati debbo boodfo, o te'i Elkaana, kanjo ma o godfo boodfo. Be didon fuu don rewa Allah, be don holla yimbe endam. Ammaa woodi ko re'i nder ngeendam

Hanna. O yidi o keba biɗngel. Ayye, no o yidi o heba biɗngel! O wadi do'a, o reeni, o wadi tammunde, o beddi reenuki. Walaa biɗngel ngari!

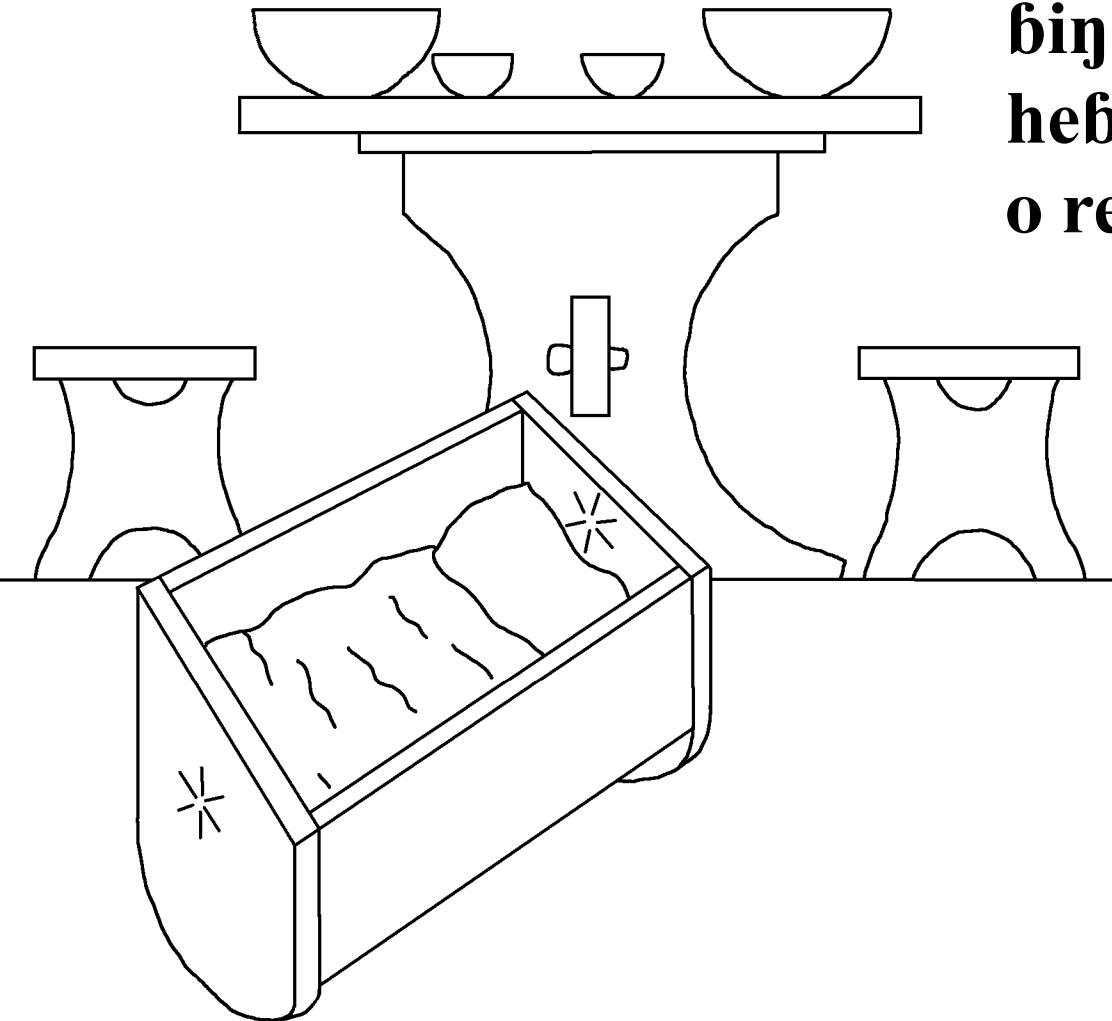



Hitaande fuu, Hanna don njaha o rewa nder Lukuru Allah. Sey hitaande feere o wadani Allah alkawal dow to O hokki mo bidfo gorko, o wartiran biɲngel ngel laata jaggindo Allah haa foroy.





**Eeli mawdo limanjo ngi'i
Hanna e o ngada do'a, o
tammi Hanna wuykoyi e
ndiyam inaboojam, ngam
lare humduko maako e
dimba ammaa
walaa sawtu
wurtata. Eeli
feli Hanna!**





**Ammaa Hanna yecci
Eeli do'a maako
ngam bingngel e
alkawal mooko haa
Allah. Eeli jaabi mo,
"Njah nder
salaaman. Allah
Isra'iila boo jaaba
tornde a tori mo do."
Bolde Eeli hokki
Hanna tammunde.**



Tikkungel sedfa, sey seyjo mawnde keewi bernde Hanna. "Jawmiraawo siftori mo," O jaabi do'a maako. Kaŋko e Elkaana, gorum, hebi bidfo gorko, be indi mo Samuyila, ma'ana (Allah nani yam). Ammaa Hanna siftoran Jawmiraawo e alkawal o ngadani Mo boo?

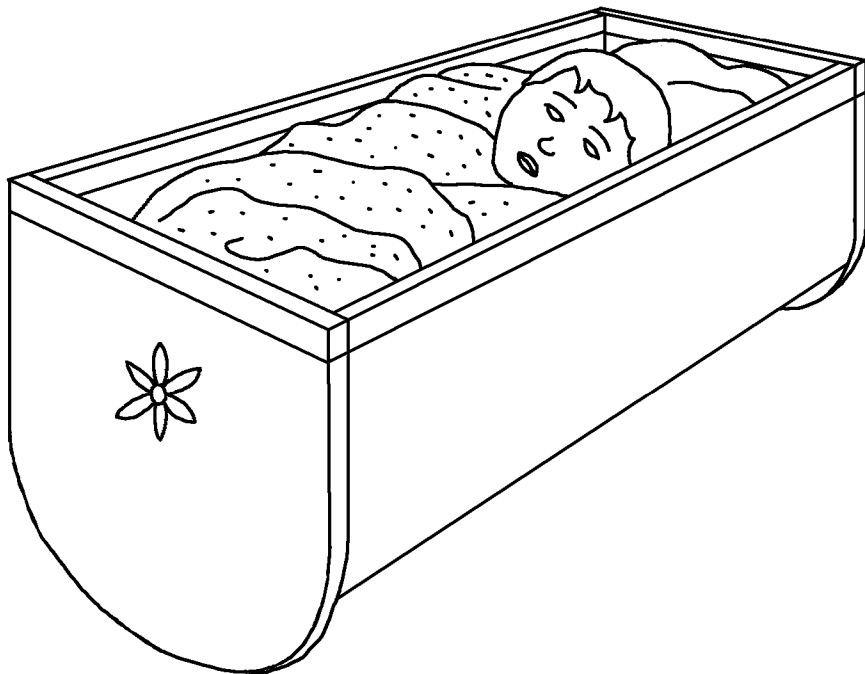



**Hanna acci yahugo
lukuru hitaande fuu.
Ayye daada am!
O yewi alkawal o
ngadani Allah na?
A'a! Hanna don
reena sey to
Samuyila mawni
yotti jodugo haa
lukuru o don wallita
Eeli kuugal jagginol
Allah tawon. Nden
Hanna waddi mo
haa lukuru man.**





**Allah mawnini
hoolaare Hanna
mawndu ndu.
Gada Samuyila,
Allah hokki mo
bibbe worbe tati e
bibbe rewbe didon.
Hitaande fuu
Hanna do njaha
lukuru o rewa
Allah, boo ngam o
ngadana Samuyila
limce o wadani mo.**



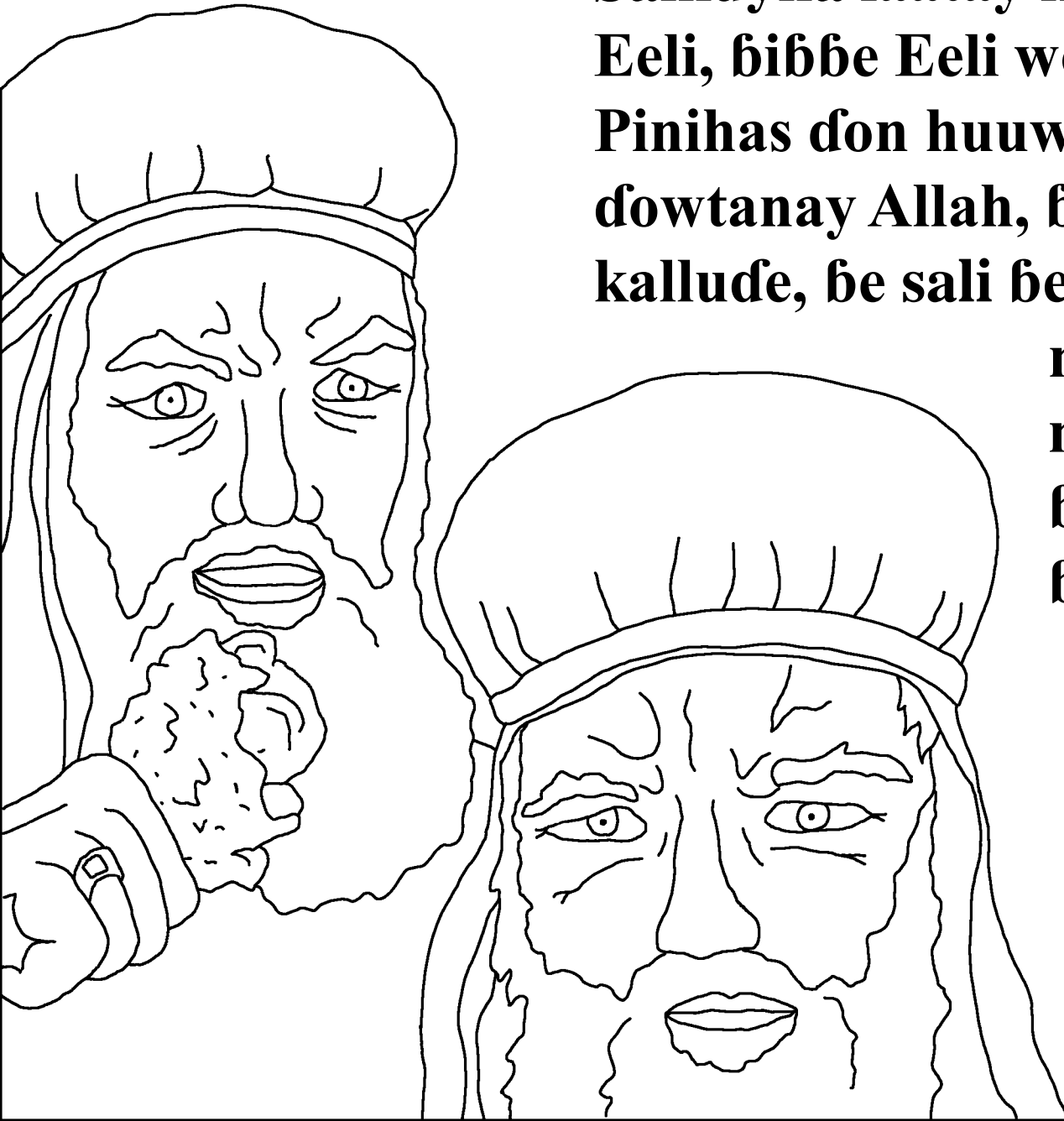

**Samuyila laatay kanƙo tan wallowo
Eeli, bibbe Eeli worbe dīdi, Hofni e
Pinihas don huuwa ton. Ammaa be
downtanay Allah, be don wada kuude
kallude, be sali be waylita kuude**

**mabbe koo nde
nyaako mabbe tori
be. Eeli riiwan no
be haa kuugal nder
lukuru ndu.**

**Ammaa o
ngaday dum.**



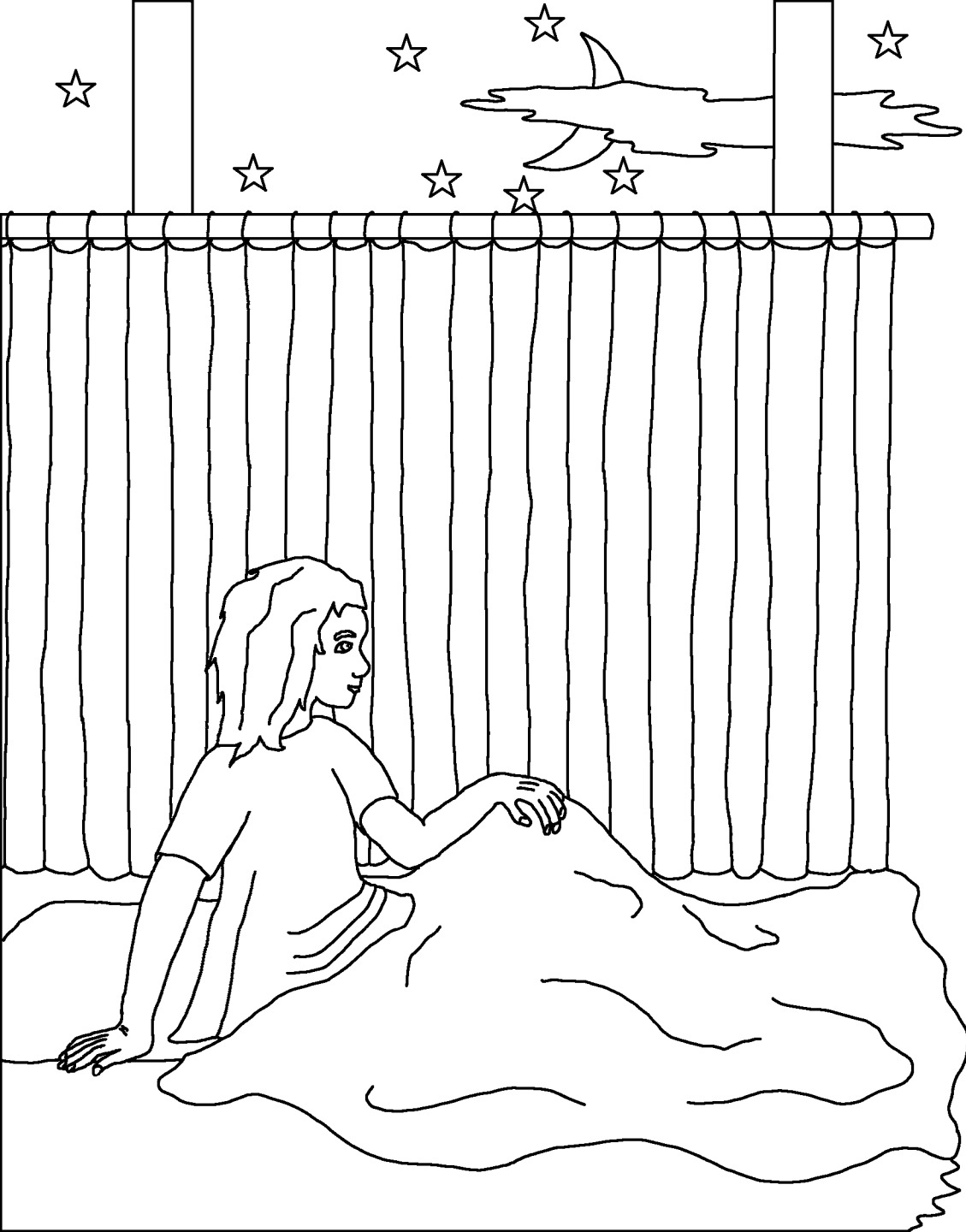

**Jemmare feere
Samuyila nani
hononde e nodda mo.
Binngel ngel numi
ɗum Eeli noddata mo.
O wi'i Eeli, "Nda yam
ɗo." Eeli jaabi mo,
"Mi nodday ma."
Du'um fudditi nde
tati. Nden Eeli andi
Allah yidi wolwana
Samuyila.**



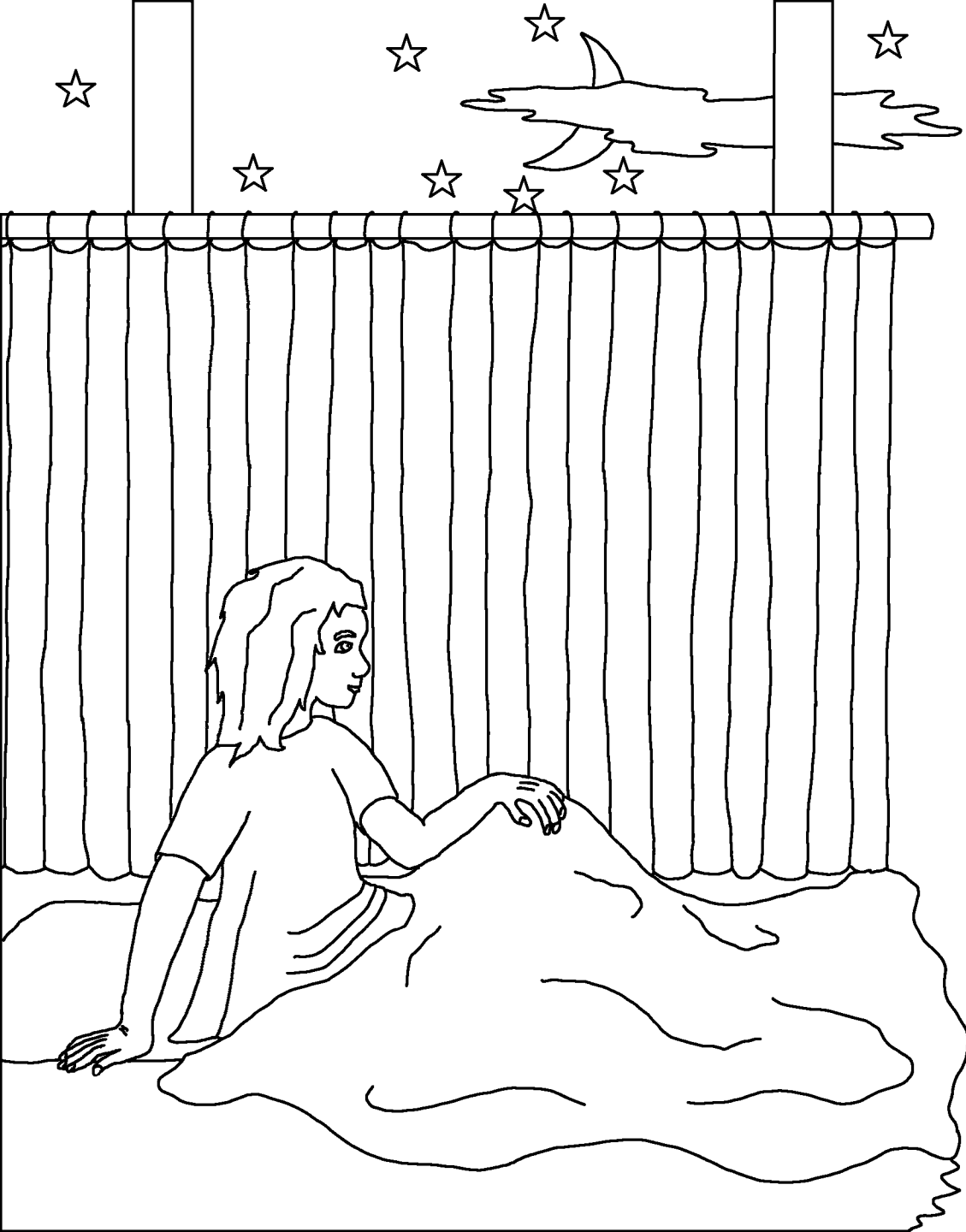

**Sey Eeli wi'i
Samuyila, "To o
noddi ma fahin,
sey mbi'a, "Wolwu
yaa Jawmiraawo,
jaggindo ma don
nana." Sey Allah
noddi fahin, O
hokki Samuyila
kongol mardum
himminaare masin.**



**Nde weeti fajjira, Eeli noddi Samuyila. O yami mo,
"Dume Jawmiraawo yecci ma?" Derkeejo do yecci mo
ko Allah wi'i mo fuu. Dum koŋngol kulniidum. Allah
halkan iyalu Eeli fuu ngam Hofni e Pinihas halli masin.**



**Sappande Allah warti goonga.
Wakkati konu bee Filisti'en,
bibbe Eeli dido ardi yeeso
honoobe Isra'iila bee Sundukru
Allah. konoobe jasti Sundukru
ndu, be mbari Hofni e Pinihas
bee Isara'iila'en duudde. Sa'i
Eeli nani ka'a, sey o do'iri
baawo dow koromwal mum,
o yewi dande mum,
o maayi nyande man.**

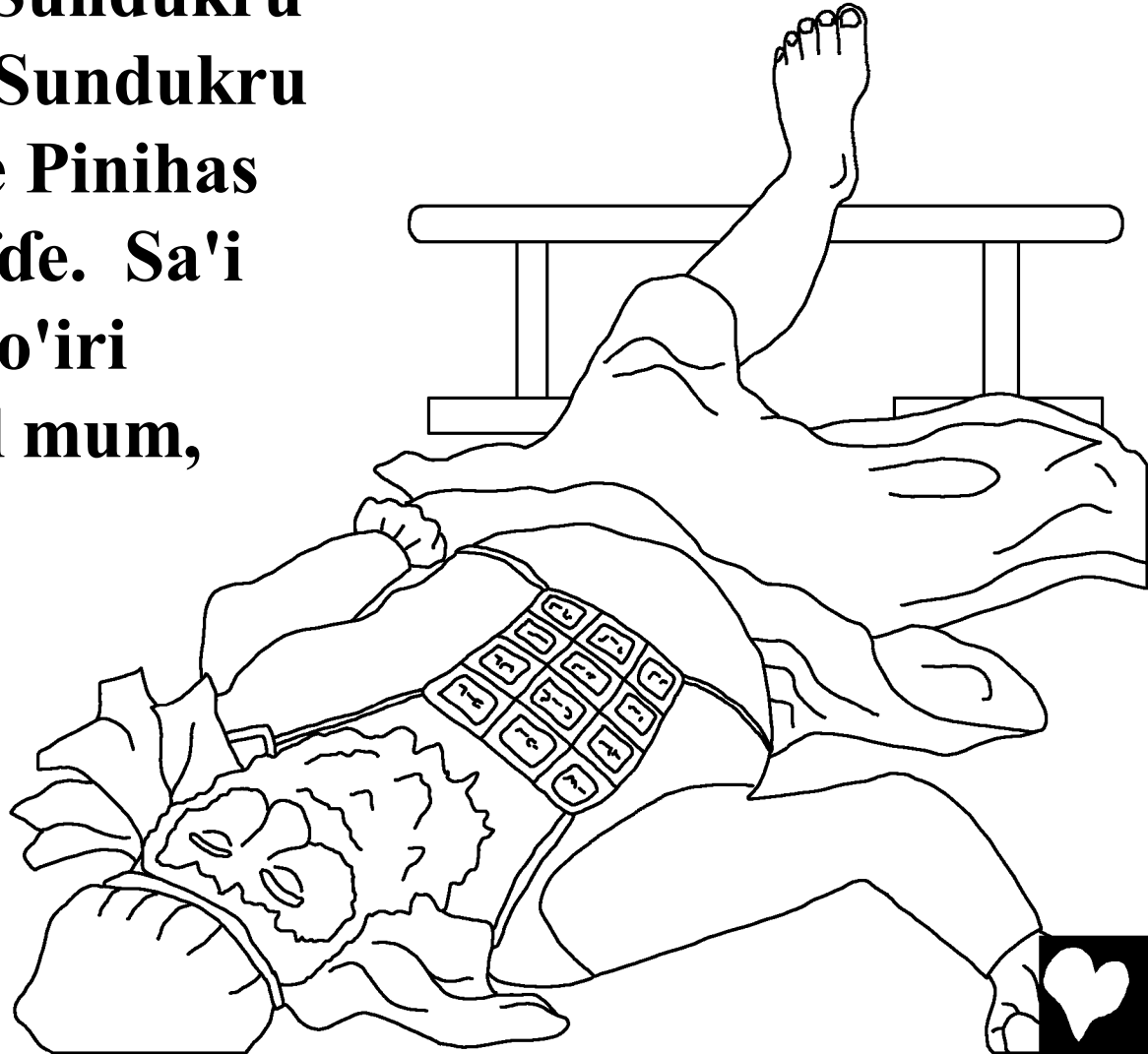

**Sundukru Allah ngaddani Filisti'en billa. Be waati dum
nder suudu lawru mabbe mbi'eteenga Dagon. Weeti
fajjiri be tawi Dago, lawru don do'iri yeeso mum.
Filisti'en banti nga, darni nga haa nokkuure maaga,
ammaa weeti fajjiri, nga don leddi fahin. Wakkati do
kam, Dagon senjaama gebe gebe.**

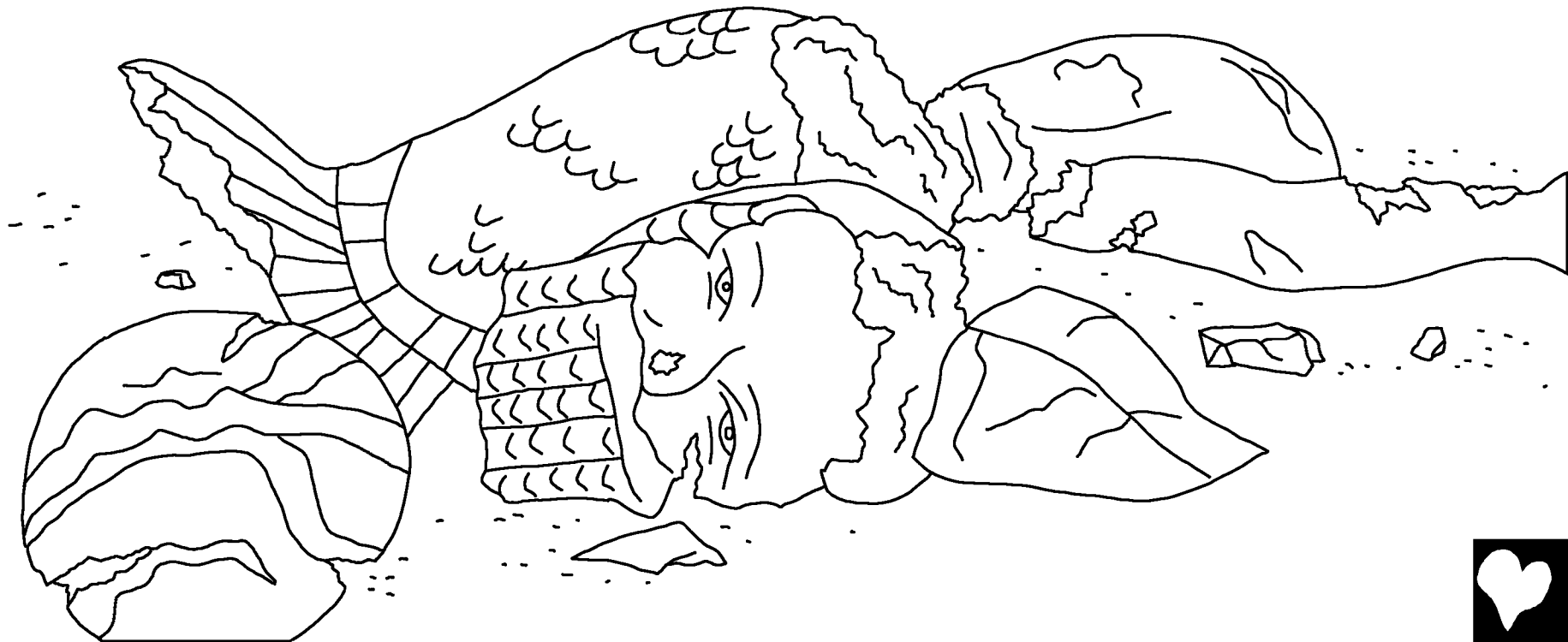

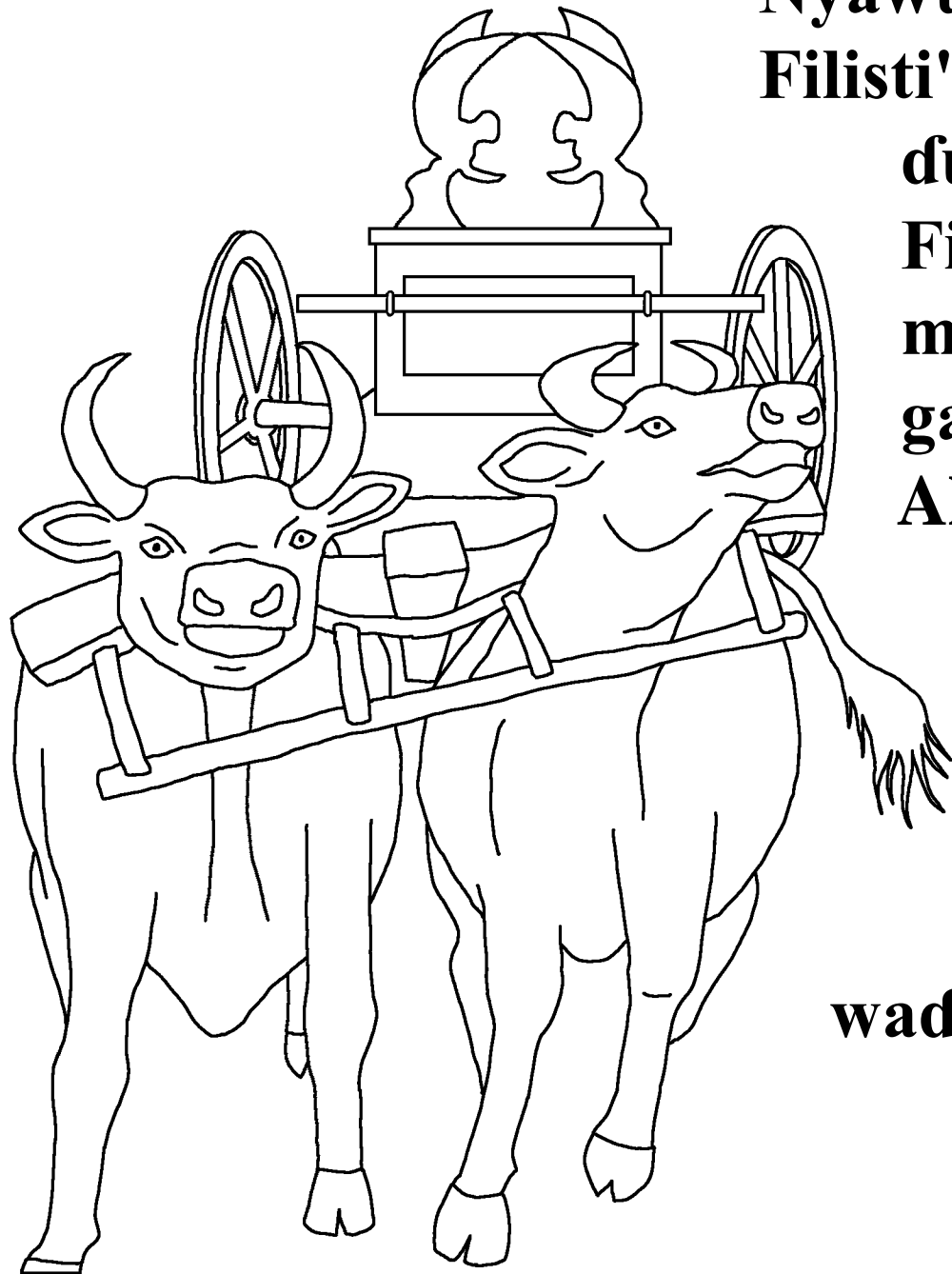

**Nyawu e waade sankiti hakkunde
Filisti'en. Ammaa ngam be laara
dum Allah on hiitata be na,
Filisti'en wadi na'i
musininooji didi dasa moota
ga'i don roondi Sundukru
Allah dow maari. Ammaa be
habbi nyalbi maaji haa
saare. Be wi'i, "To na'i
musininooji di'i njahi to
Isra'iila, acci nyalbi maaji
haa saare, en andan Allah
wadi dum." Sey na'i din wa'iti!**



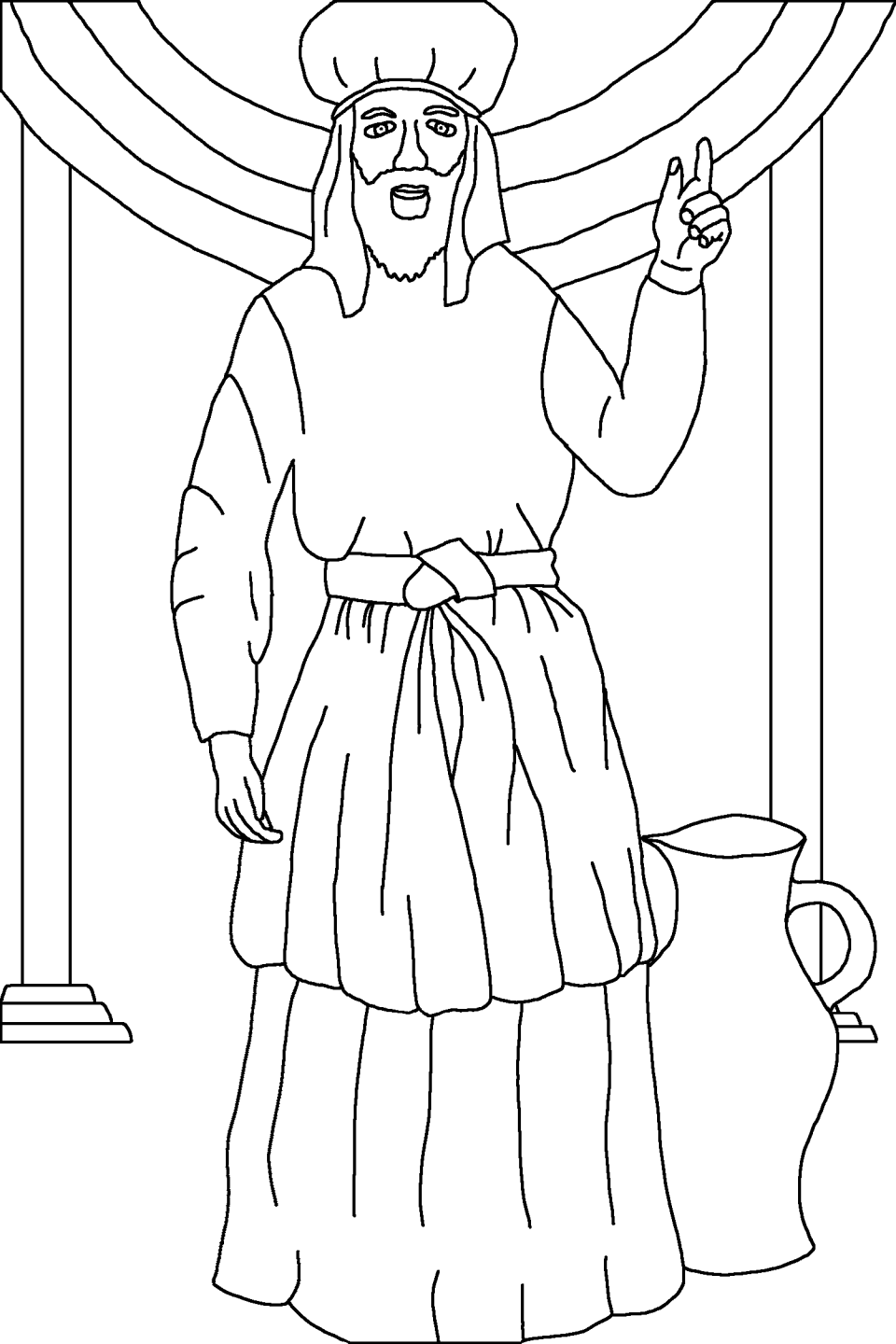

Nden Samuyila mo mawni jonta kam, wolwani yimbe Isra'iila fuu. Wi'i, "To on loraani Jawmiraawo bee bernde moodon fuu... O hisnan on haa jungo Filisti'en." Yimbe d'owtani annabiijo Allah koolaado. Sey Allah hokki jaalorgal dow Filisti'en nder balde Samuyila fuu.



Samuyila- Biɗngel Gorko Jaggoowo Allah

Tariya ha nder Wolde Allah, Deftere,

tawama ha nder

1 Samuyila 1-7

"Damugal Wolde Mada don hokka jayngol."

Jaabura 119:130



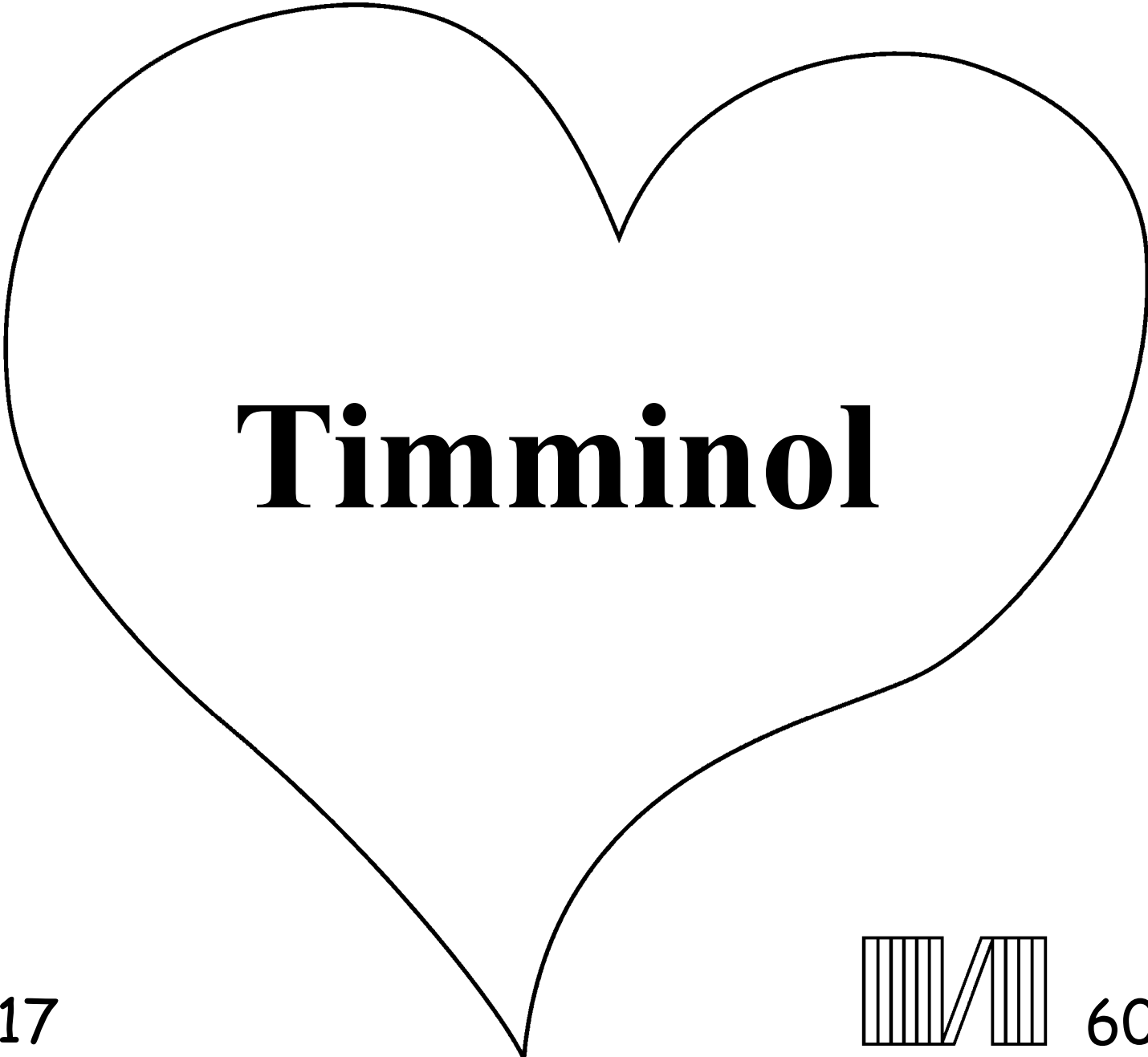

Timminol



17

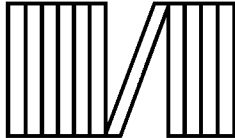

60



**Tariya Deftere ndu don wolwina amin do Allah
amin je boddo je taggi amin e je yidi ha en aanda Mo.**

**Allah aandi min ngadi kujeji kalludum, je O ewnatta hakke.
Eltare aybe dum wade, ama Allah yidi ma be gonga e O nelli
no Biddo mako je gooto, Yesu, ha o maya do Gafangal e be elta
Mo ngam aybe mada, Nden Yesu finni nder wade e dilli ha saare
ha asaman! To a don nuddina Yesu e emmi mo ngam ha O
yaffa hakkeji mada, O wadan dum. O waran e O wondan
be ma jonta, e a wondan be Mako ha abada.**

To a tammi dum gonga, Yeccu do ha Allah:

**Yesu am, mi don nuddina an woni Allah, e lati neddo ngam
mayugo ngam hakkeji am, jonta A don yedda fahin. Useini nastu
ha nde jonde am e yafanam hakkeji am, ngam ha jonde am sanja
jonta, e yende feere mi wonda be ma ha abada. Wallam ngam
hedditugo Ma e yedda ngam Ma bana biddo Ma. Amina.**

Jaangu Deftere e ngewtu be Allah tum tum! Yohonna 3:16

