

# Deftere Bikkon

## Don sappina

# Samuyila- Biɗngel Gorko Jaggoowo Allah



Windowo: Edward Hughes

Didowo: Janie Forest  
Alastair Paterson

Mo'inowo: Lyn Doerksen

Lornowo: The Bible Society of Nigeria

Wanginowo: Bible for Children  
[www.M1914.org](http://www.M1914.org)

©2024 Bible for Children, Inc.

Jarfuye: A don mari jarfu windugo mala wurtinugo tariya  
ndu nder masin, to na je sippugo.

Hanna laati debbo boodfo, o te'i Elkaana, kanƙo ma o  
goddo boodfo. Be didon fuu don rewa Allah, be don holla  
yimbe endam. Ammaa woodi ko re'i nder ngeendam

Hanna. O yidi o keba  
biɗngel. Ayye, no o yidi o  
heba biɗngel! O wadi do'a,  
o reeni, o wadi tammunde,  
o beddi reenuki.  
Walaa biɗngel ngari!

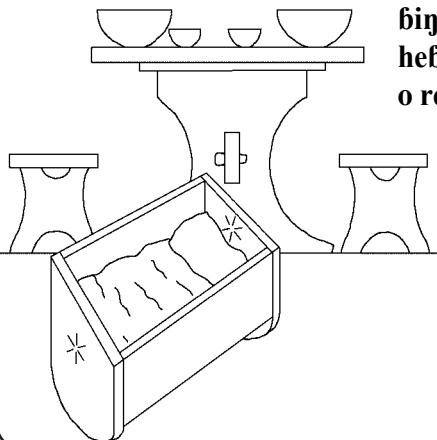



Hitaande fuu, Hanna don njaha o rewa nder Lukuru Allah. Sey hitaande feere o wadani Allah alkawal dow to O hokki mo biɗɗo gorko, o wartiran biɗɗel ngel laata jaggindo Allah haa foroy.

3

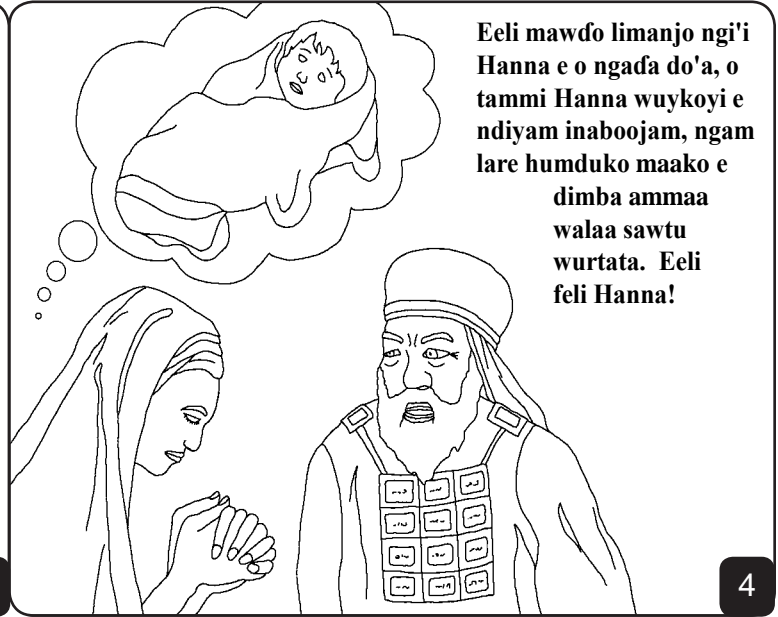

Eeli mawɗo limanjo ngi'i Hanna e o ngada do'a, o tammi Hanna wuykoyi e ndiyam inaboojam, ngam lare humduko maako e dimba ammaa walaa sawtu wurtata. Eeli feli Hanna!

4

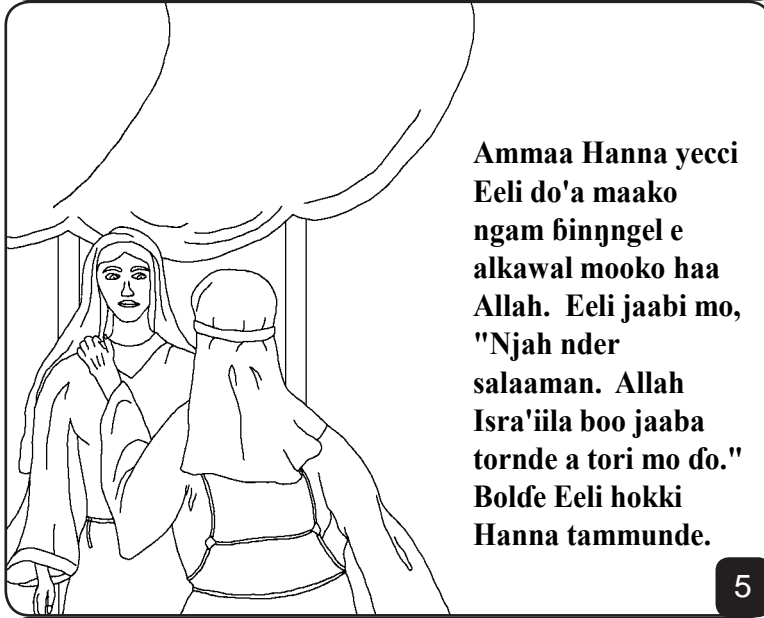

Ammaa Hanna yecci Eeli do'a maako ngam biɗɗel e alkawal mooko haa Allah. Eeli jaabi mo, "Njah nder salaaman. Allah Isra'iila boo jaaba tornde a tori mo do." Bolɗe Eeli hokki Hanna tammunde.

5

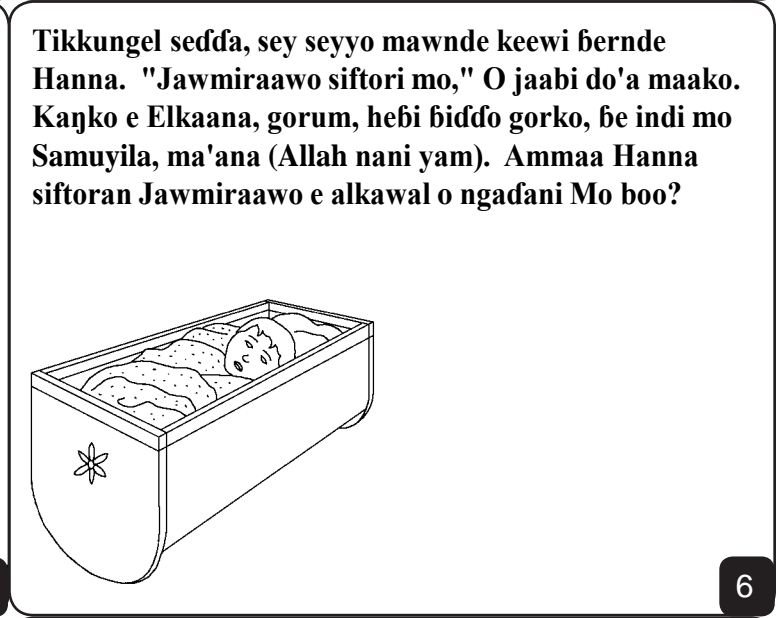

Tikkungel seɗɗa, sey seygo mawnde keewi bernde Hanna. "Jawmiraawo siftori mo," O jaabi do'a maako. Kaŋko e Elkaana, gorum, hebi biɗɗo gorko, be indi mo Samuyila, ma'ana (Allah nani yam). Ammaa Hanna siftoran Jawmiraawo e alkawal o ngadani Mo boo?

6

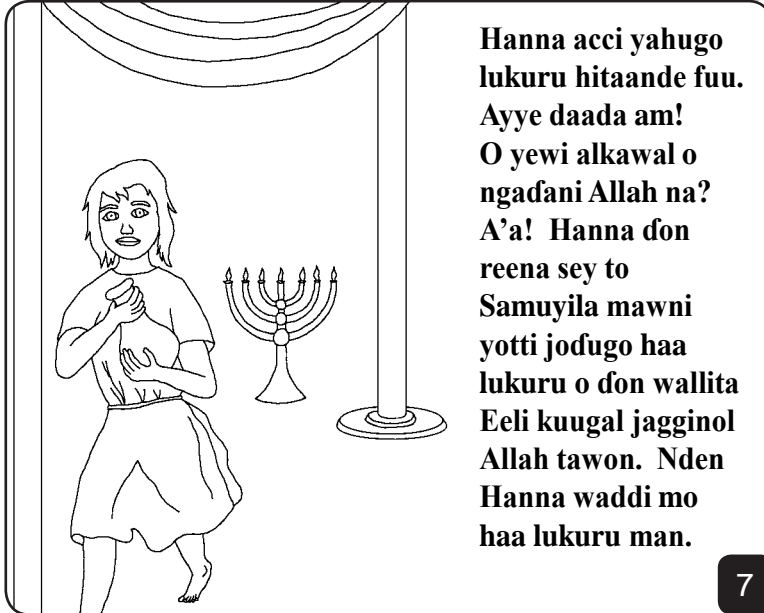

Hanna acci yahugo lukuru hitaande fuu. Ayye daada am! O yewi alkawal o ngadani Allah na? A'a! Hanna don reena sey to Samuyila mawni yotti jodugo haa lukuru o don wallita Eeli kuugal jagginol Allah tawon. Nden Hanna waddi mo haa lukuru man.

7

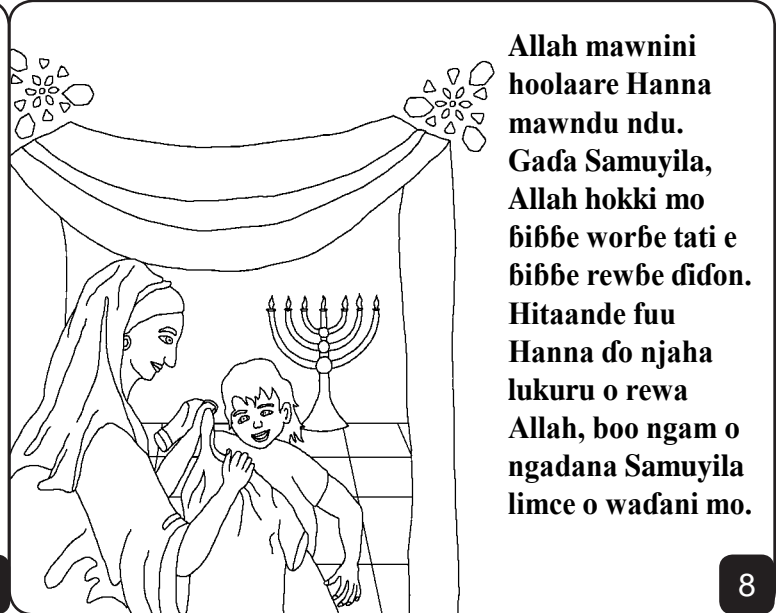

Allah mawnini hoolaare Hanna mawndu ndu. Gaɗa Samuyila, Allah hokki mo bibbe worbe tati e bibbe rewbe didon. Hitaande fuu Hanna do njaha lukuru o rewa Allah, boo ngam o ngadana Samuyila limce o wadani mo.

8

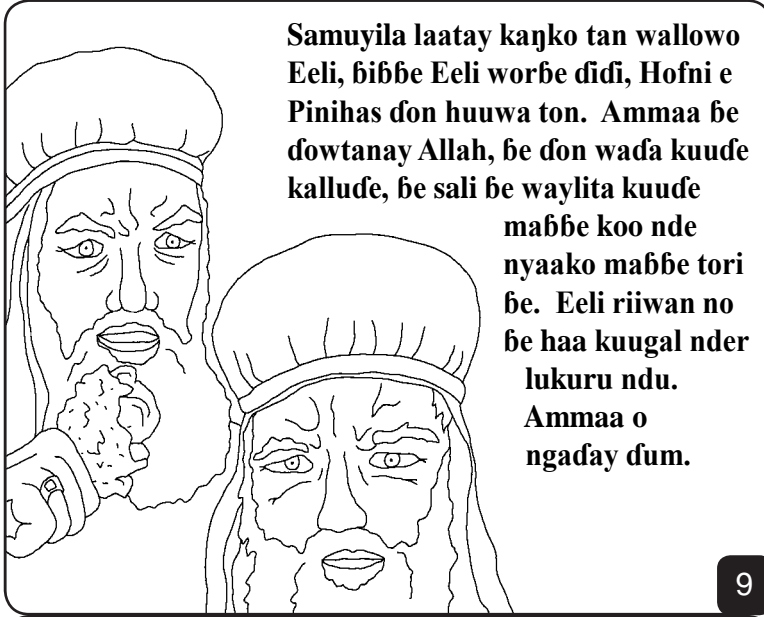

Samuyila laatay kanƙo tan wallowo Eeli, bibbe Eeli worbe didi, Hofni e Pinihas don huuwa ton. Ammaa be downtanay Allah, be don wada kuude kallude, be sali be waylita kuude mabbe koo nde nyaako mabbe tori be. Eeli riiwan no be haa kuugal nder lukuru ndu. Ammaa o ngaday dum.

9

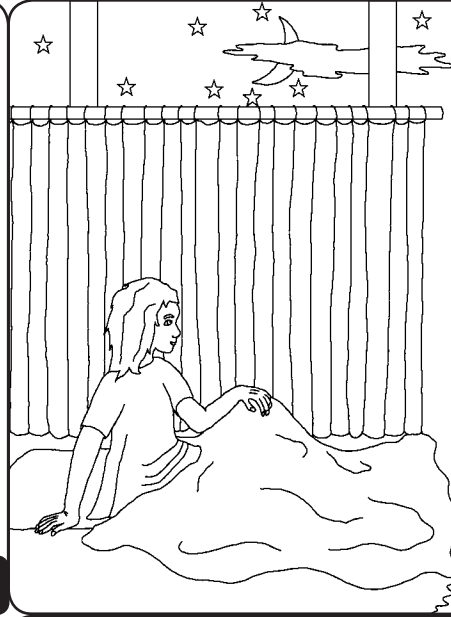

Jemmare feere Samuyila nani hononde e nodda mo. Binnngel ngel numi dum Eeli noddata mo. O wi'i Eeli, "Nda yam do." Eeli jaabi mo, "Mi nodday ma." Du'um fudditi nde tati. Nden Eeli andi Allah yidi wolwana Samuyila.

10

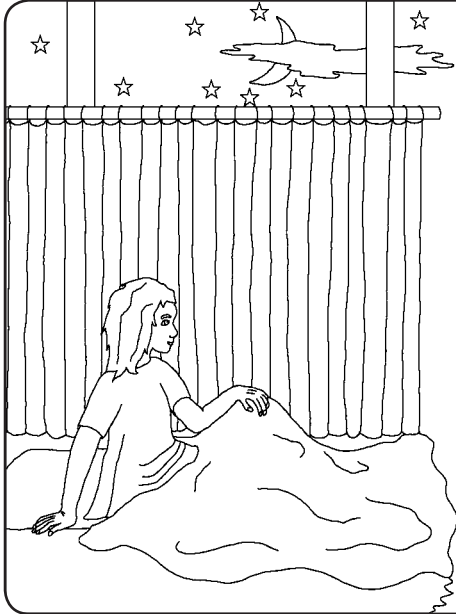

Sey Eeli wi'i Samuyila, "To o noddi ma fahin, sey mbi'a, "Wolwu yaa Jawmiraawo, jaggindo ma don nana." Sey Allah noddi fahin, O hokki Samuyila kongol mardum himminaare masin.

11



Nde weeti fajjira, Eeli noddi Samuyila. O yami mo, "Dume Jawmiraawo yecci ma?" Derkeejo do yecci mo ko Allah wi'i mo fuu. Dum kongol kulniidum. Allah halkan iyalu Eeli fuu ngam Hofni e Pinihas halli masin.

12

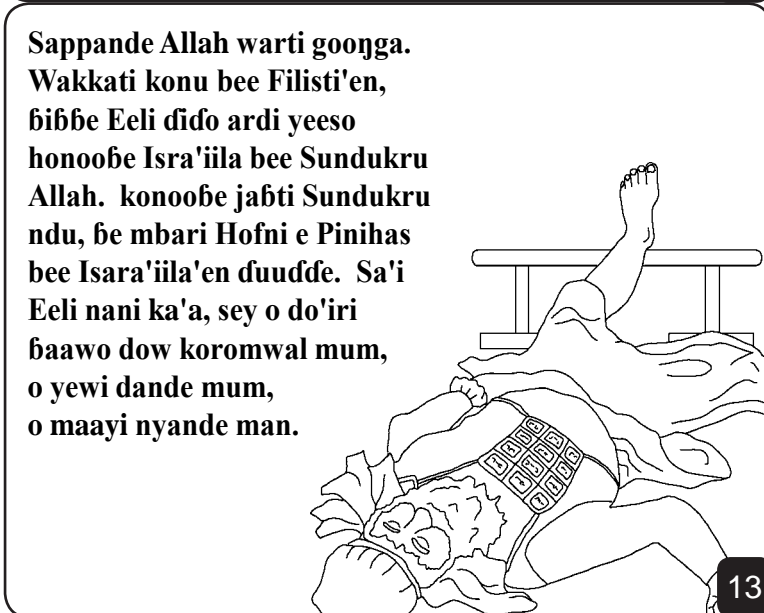

Sappande Allah warti goonga. Wakkati konu bee Filisti'en, bibbe Eeli dido ardi yeeso honoobe Isra'iila bee Sundukru Allah. konoobe jabti Sundukru ndu, be mbari Hofni e Pinihas bee Isara'iila'en duudde. Sa'i Eeli nani ka'a, sey o do'iri baawo dow koromwal mum, o yewi dande mum, o maayi nyande man.

13

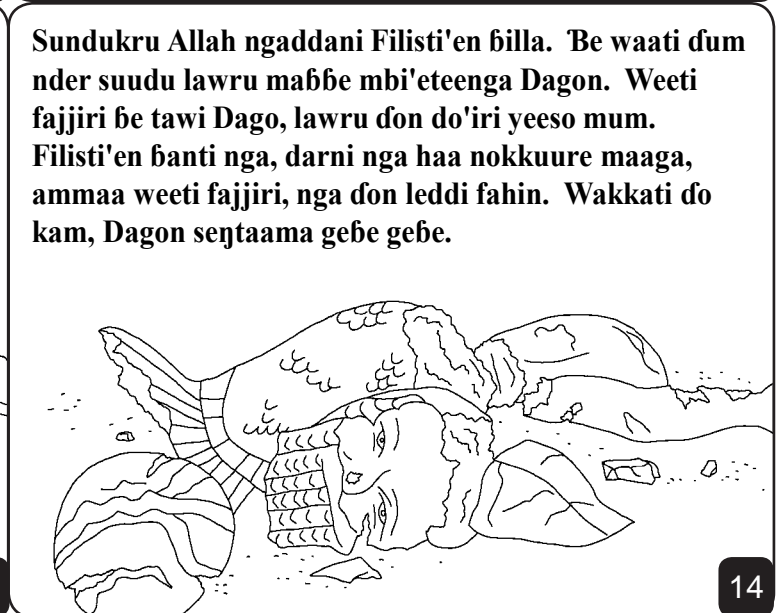

Sudukru Allah ngaddani Filisti'en billa. Be waati dum nder suudu lawru mabbe mbi'eteenga Dagon. Weeti fajjiri be tawi Dago, lawru don do'iri yeeso mum. Filisti'en banti nga, darni nga haa nokkuure maaga, ammaa weeti fajjiri, nga don leddi fahin. Wakkati do kam, Dagon seŋtaama gebe gebe.

14

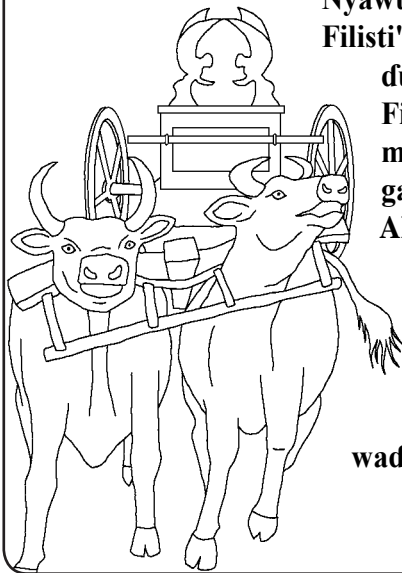

Nyawu e waade sankiti hakkunde Filisti'en. Ammaa ngam be laara dum Allah on hiitata be na, Filisti'en wadi na'i musininooji didi dasa mootaga'i don roondi Sundukru Allah dow maari. Ammaa be habbi nyalbi maaji haa saare. Be wi'i, "To na'i musininooji di'i njahi to Isra'iila, acci nyalbi maaji haa saare, en andan Allah wadi dum." Sey na'i din wa'iti!

15



Nden Samuyila mo mawni jonta kam, wolwani yimbe Isra'iila fuu. Wi'i, "To on loraani Jawmiraawo bee bernde moodon fuu... O hisnan on haa jungo Filisti'en." Yimbe dwtani annabiijo Allah koolaado. Sey Allah hokki jaalorgal dow Filisti'en nder balde Samuyila fuu.

16

**Samuyila- Biingel Gorko Jaggoowo Allah**

**Tariya ha nder Wolde Allah, Deftere,**

**tawama ha nder**

**1 Samuyila 1-7**

**"Damugal Wolde Mada don hokka jayngol."  
Jaabura 119:130**

17



17

60

18

Tariya Deftere ndu don wolwina amin do Allah amin je bodfo je taggi amin e je yidi ha en aanda Mo.

Allah aandi min ngadi kujeji kalludum, je O ewnatta hakke. Eltare aybe dum wade, ama Allah yidi ma be gonga e O nelli no Bidfo mako je gooto, Yesu, ha o maya do Gafangal e be elta Mo ngam aybe mada, Nden Yesu finni nder wade e dilli ha saare ha asaman! To a don nuddina Yesu e emmi mo ngam ha O yaffa hakkeji mada, O wadan dum. O waran e O wondan be ma jonta, e a wondan be Mako ha abada.

To a tammi dum gonga, Yeccu do ha Allah: Yesu am, mi don nuddina an woni Allah, e lati nedfo ngam mayugo ngam hakkeji am, jonta A don yedfa fahin. Useini nastu ha nde jonde am e yafanam hakkeji am, ngam ha jonde am sanja jonta, e yende feere mi wonda be ma ha abada. Wallam ngam hedditugo Ma e yedfa ngam Ma bana bidfo Ma. Amina.

Jaangu Deftere e gewtu be Allah tum tum! Yohonna 3:16

19