

**Deftere Bikkon**  
**Don sappina**

**Inuusa e Liingu**  
**Mawndu**



**Windowo: Edward Hughes**

**Didowo: Jonathan Hay; Alastair Paterson**

**Mo'inowo: Mary-Anne S.**

**Lornowo: The Bible Society of Nigeria**

**Wanginowo: Bible for Children**

**[www.M1914.org](http://www.M1914.org)**

**©2024 Bible for Children, Inc.**

**Jarfuye: A don mari jarfu windugo mala wurtinugo tariya  
ndu nder masin, to na je sippugo.**



**Duubi duuddi nebude, woodi godfo  
mbi'eteedo Inuusa, mo joodi nder leddi  
Isra'iila. Nyalaade feere Allah wi'i  
mo o njaha Niineba berniwol  
mawndu, burda  
sembe nder  
duuniyaaru.**

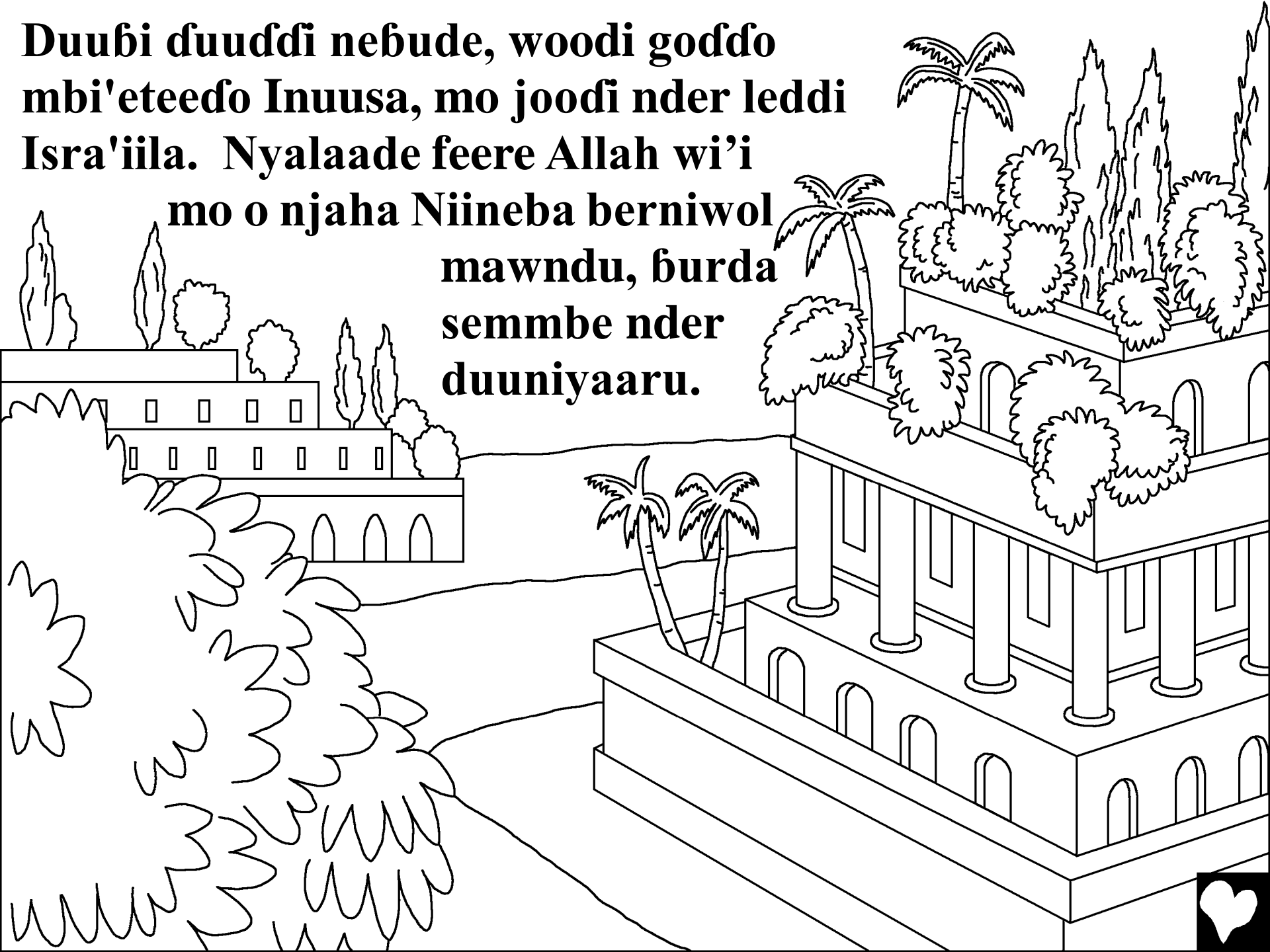

**Be wi'i Inuusa dow o sappana  
yimbe ngonbe Niineba dow Allah  
anndi halleende mabbe.**

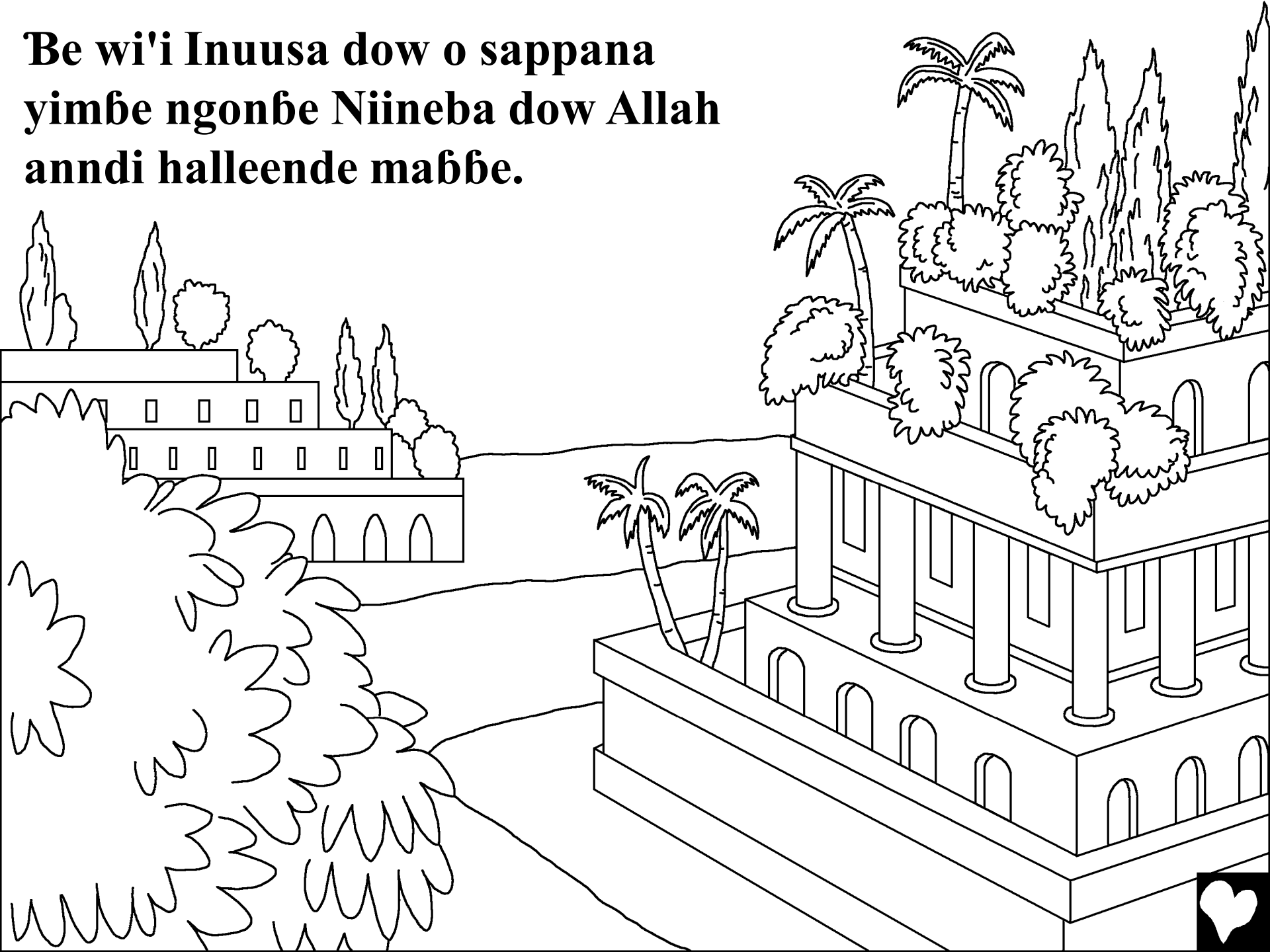

**Inuusa dɔwtanay umroore Allah!  
Maymako yahuki Niineba, Inuusa  
nasti komiwal njahata Tarsis  
berniwol titotiri bee Niineba.**



**Sey Jawmiraawo Allah leldi heendu saattudum dow  
mbeela ndin. Woodi naargewol semmbidngol!  
Laanyoobe ndi kultori komiwal ndin sejtoto, muta nder  
mbeela.**

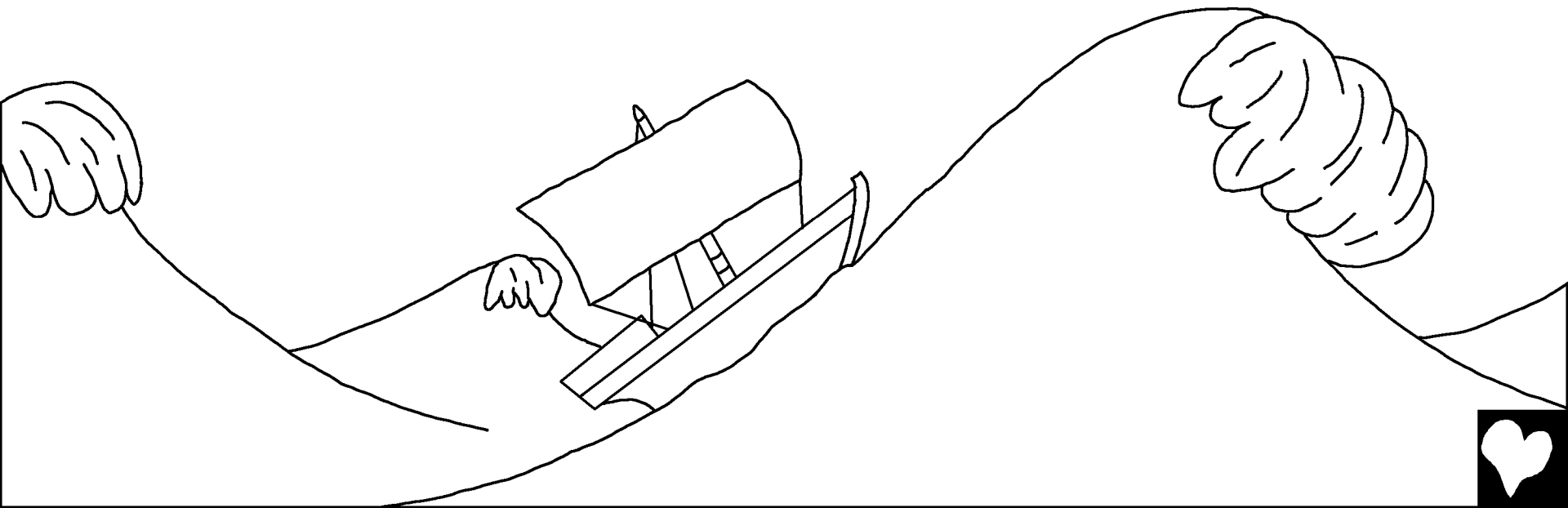

**Heendu ndin beddi saatugo. Laanyoobe ben kultori, be ngadi do'a to dowanteebe mabbe, be nguddini donje mabbe fuu nder mbeela ngam hoyniki teddeenga komiwal maajum. Ammaa dum wallay koo dume.**



**Nder ngonbe dow komiwal maajum, Inuusa on tan ngaday do'a. Ammaa o ton waali daanoya nder komiwal maajum. Mawdo laanyoobe komiwal maajum ngari to maako, yami mo, "Ko ngadayta, a daanoto? Umma, do'ana Allah maada! Ego Allah numan en, ngam taa en halka."**



**Tikkungel sedfa, laanyoobe maajum tayi haala dow woodi ko hawti torra mabbe bee Inuusa. O yecci be o don dogga yeeso Jawmiraawo. Be yami mo, "Dume min ngadata ma ngam haa mbeela de'ana min?" Inuusa wi'i be, "Koose am sakkinami nder mbeela, ngam mi anndi fakat naargewol semmbidngol ngo'ol ukkani on daliila am."**



**Laanyoobe ben ngidaa  
be sakkina Innusa nder  
mbeela. Ngam maajum  
be laanyi bee semmbe  
ngam be lorna  
komiwal maajum  
haa fomoonde.**

**Ammaa be  
waawaay.  
Ko ngadete  
go'otel tan!**

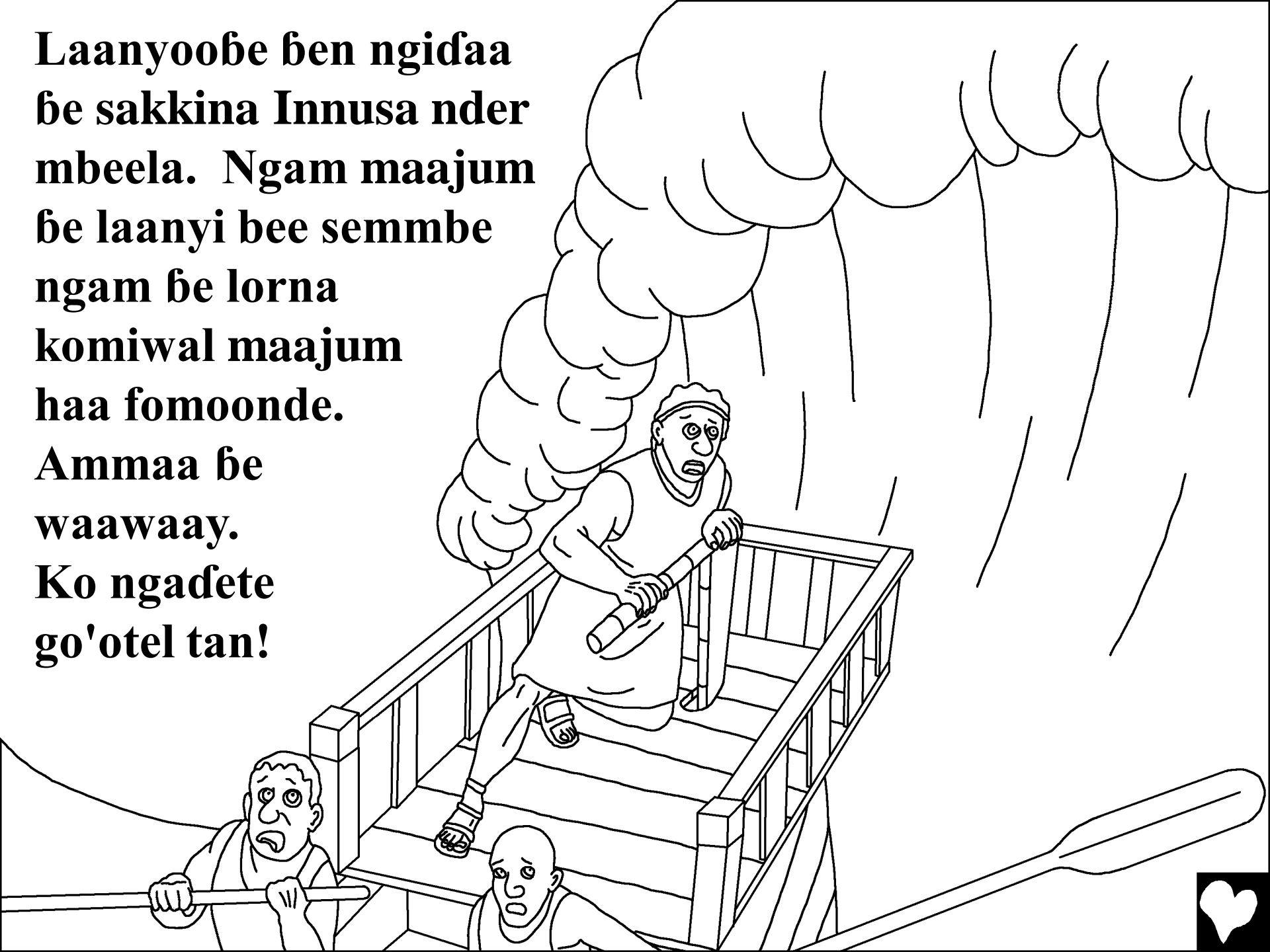

**Gada be ngadi do'a yaafoore, laanyoobe ben  
koosi Inuusa dow, be sakkini mo  
nder mbeela.**

**Nde Inuusa  
muti nder  
ndiyam, sey  
mbeela de'iti, heendu dari  
cip. Waylitaade be hebi don  
e don do hulni laanyoobe ben  
buri naargewol ndin. Be  
anndi Allah tan ngadata  
dum. Ngam maajum  
nder kulol e kayniki,  
be rewi Jawmiraawo.**



**Nder mbeela, lilaado mo  
dowtaanay umrore on  
hebi kaayee fi mangol.  
O yoo fi bandu o don  
muta nder luggudum  
mbeela maajum, Inuusa  
anndi wala ko hisnata mo  
maayde. O maayoto boo,  
ammaa Allah woodi  
godfi dabareji.**

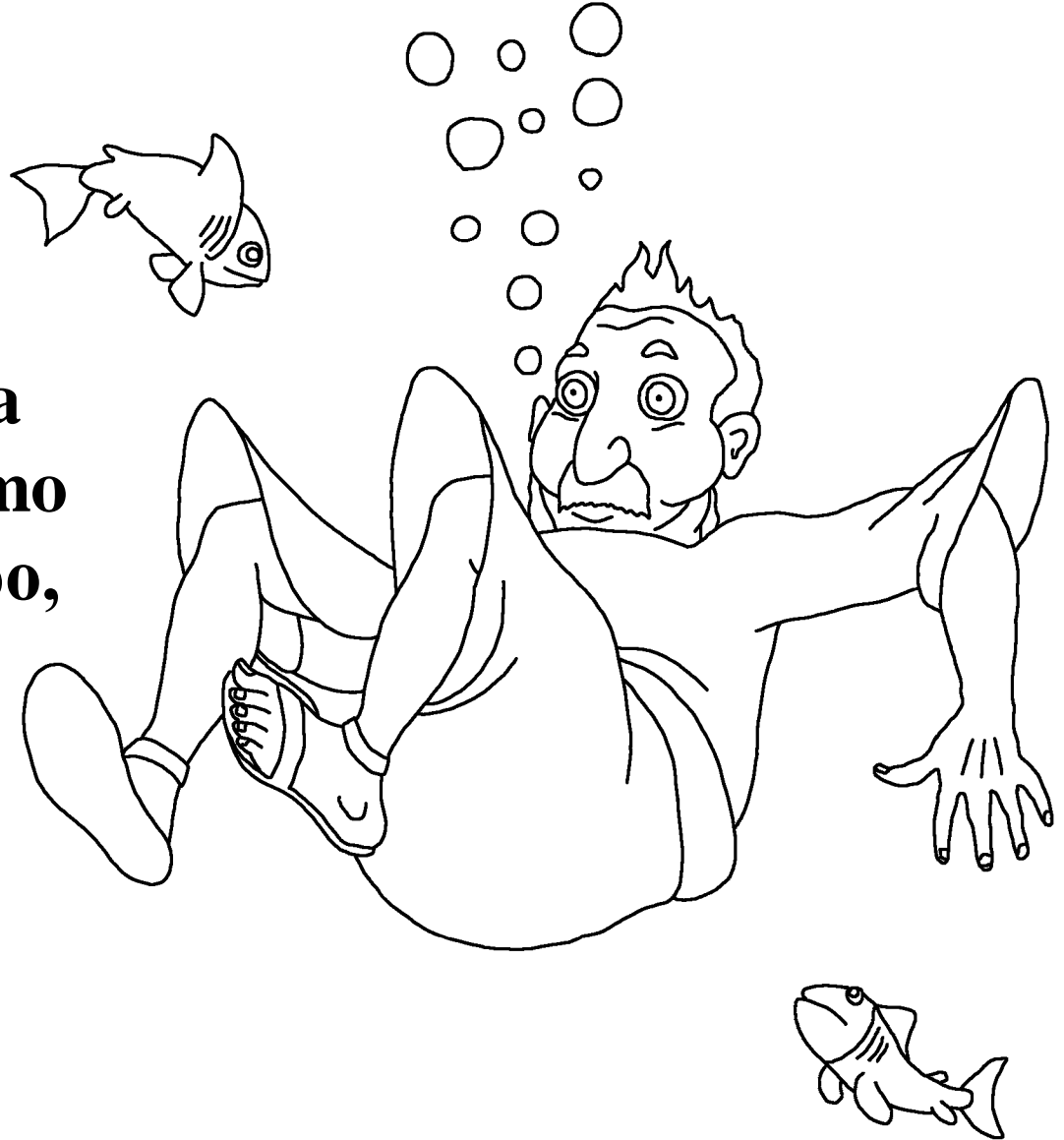

**Jawmiraawo siryi liingu maɲngu, ngu moda Inuusa.  
Liingu ngu'u ngadi dum nder wakkati! Modande  
go'otel, Inuusa acci mbeela nasti reedu  
liingu. Inuusa hoosi balde tati nder  
reedu liingu ngu'u. O woodi wakkati  
duuddum ngam o numa,  
nden boo o ngada do'a.**

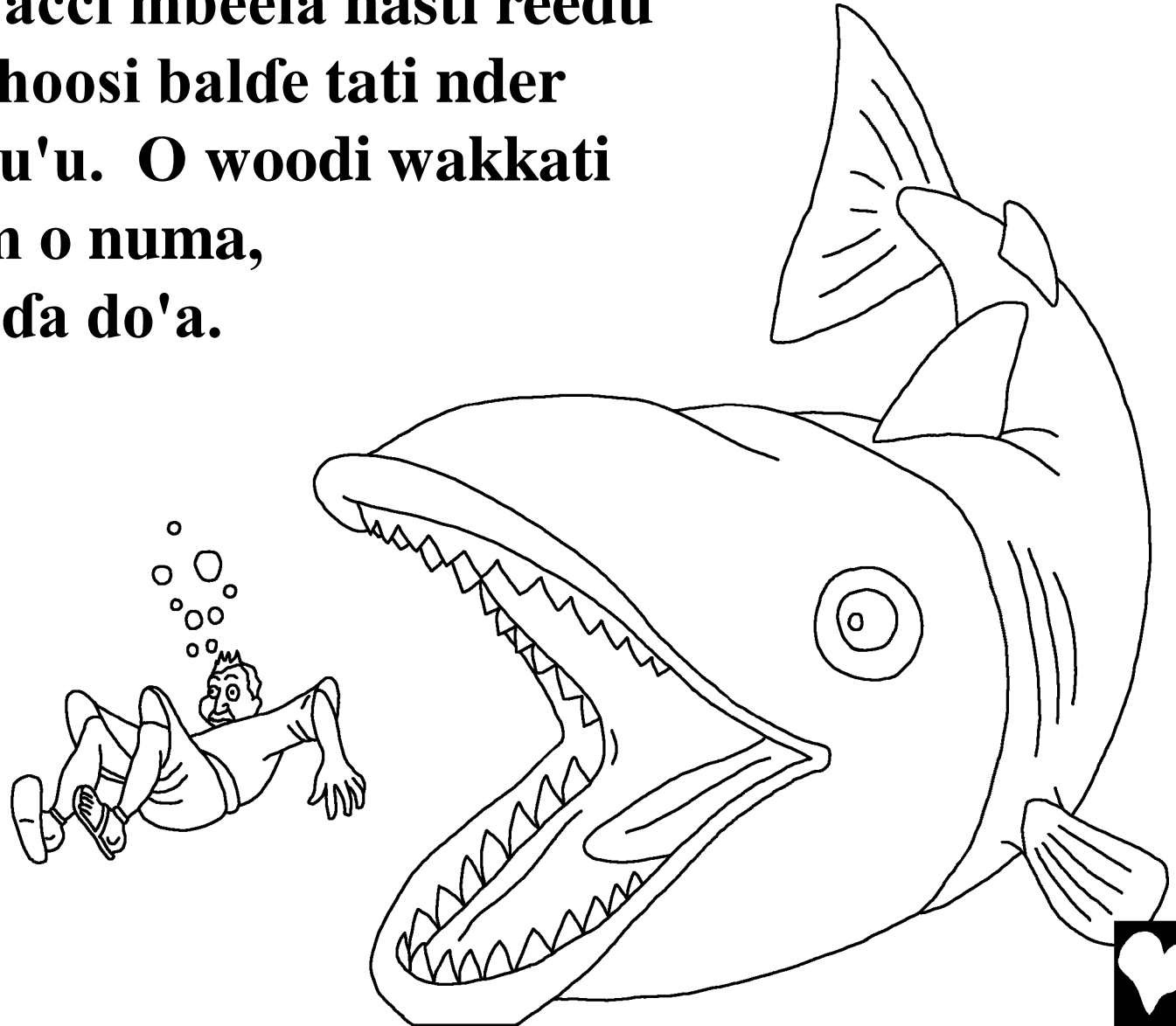

**Balde tati gada don, Inuusa wadi alkawal o dɔwtanan umroore Allah. Don e don, Allah umri liingu ngu'u, ngu tuuti Inuusa haa foomnde.**

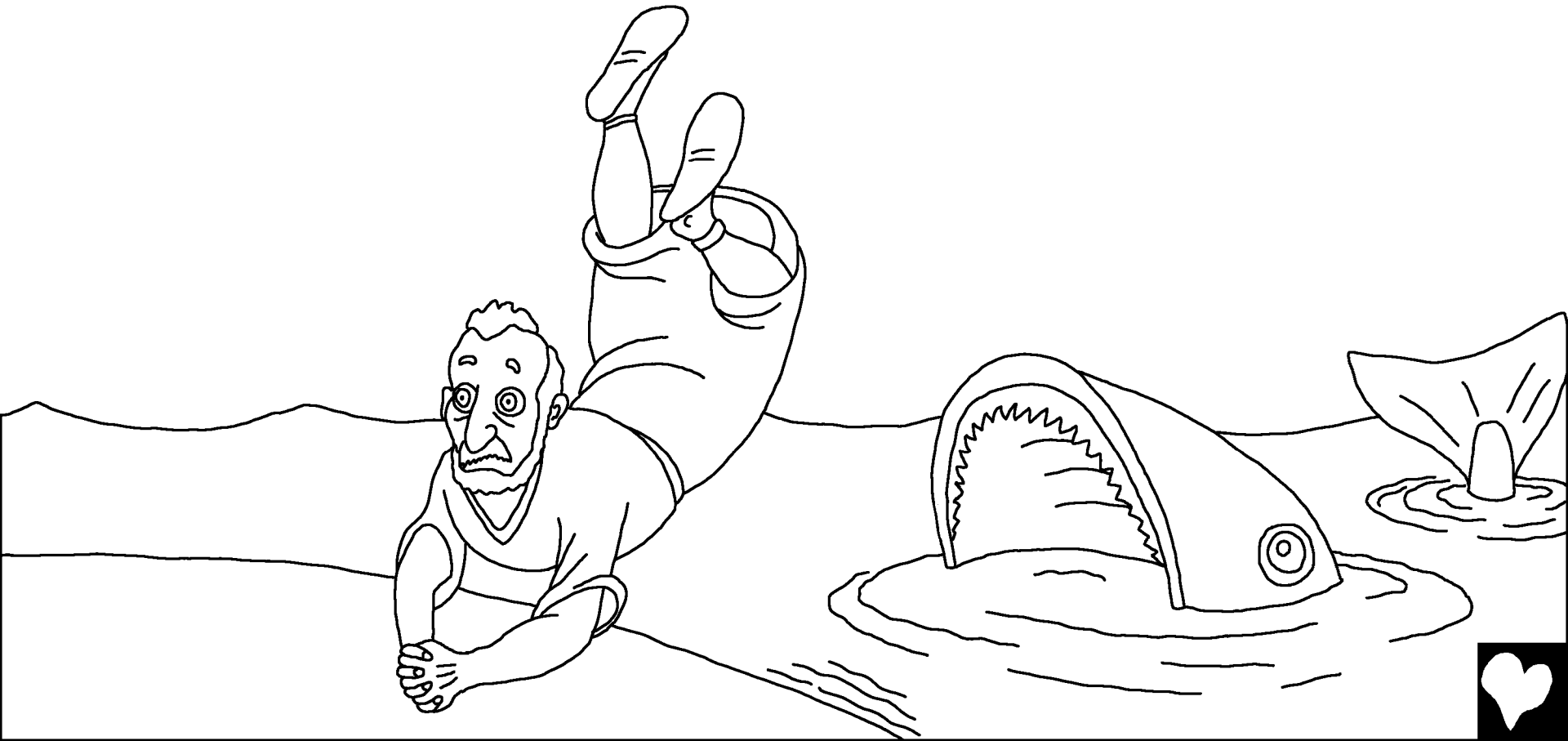

**Allah yecci Inuusa fahin dow o njaha Niineba, o wa'ajana be wolde Allah. Wakkati do kam, Inuusa njehi! O nasti nder berniwol Niineba, o don bangina, "Nder balde sappande nayi, Niineba halkoto."**



**Yimbe Niineba nuɗɗini wolde Allah. Be suumi, be  
borni buhuuje ngam ɗum holla Allah be wasmiti  
hakkeji mabbe. Laamiido e hoore muudum lestini  
hoore maako yeeso Allah. O jippi leeso laamu maako,  
o borni buhuuje, o joodi nder dodɗe. O hokki umrore  
koo moye acca laawol kallungol  
e kuude kallude mum,  
be ngada do'a dow  
Jawmiraawo yaafana be.**

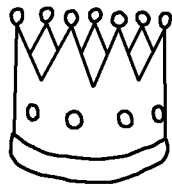

**Allah yaafi be boo! Dum laatan nyalaade seyyo kayniiga  
nder Niineba, sa'i yimbe hebti Allah yaafi  
be. Ammaa dum mettani**

**goddo gooto  
masin. Dum  
Inuusa!**



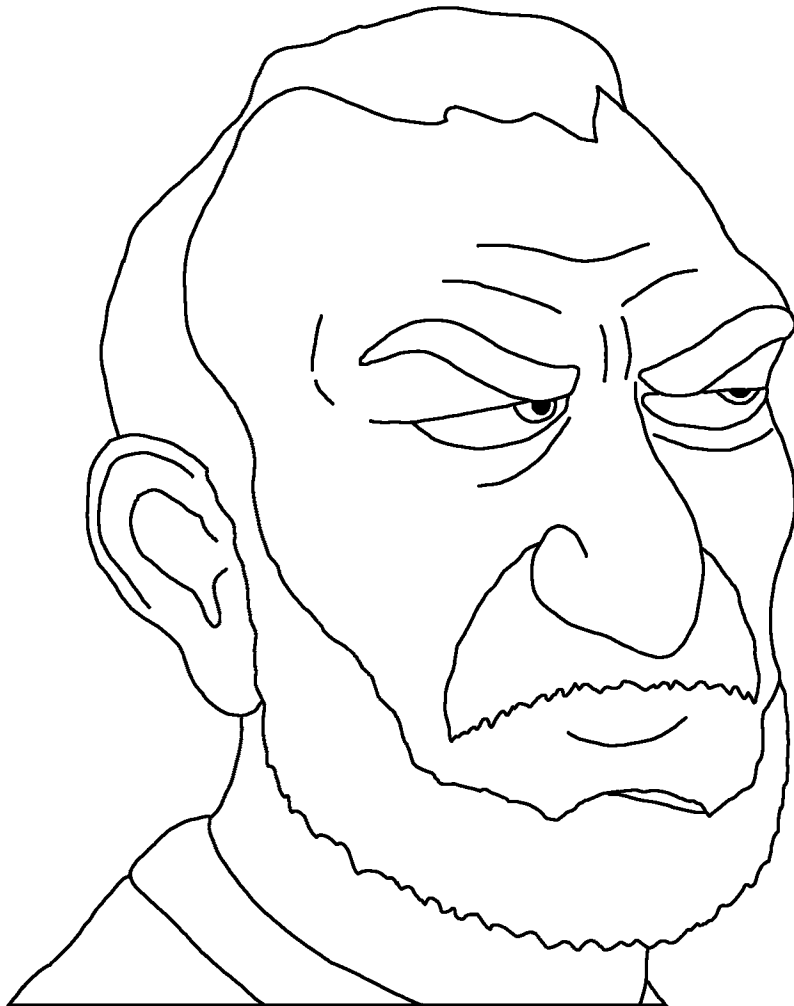

**Ko wadi Inuusa mettani?  
O yecci no Allah dow, "Mi  
anndi a mardo endam e  
hinnuye, a tikkataa law,  
mawdo nder mboodeenga."  
Dum holli, Inuusa anndi  
Allah don yaafana be  
wasmiti hakkeeji mabbe  
dowtani wolde Allah. Dum  
holli bana Inuusa yidaa  
yimbe Niineba. O yidaa  
be yaafanaa be.**



**Inuusa tikkani Allah haa o wi'i mo, "Ittu yonki  
am, ngam ndikkanammi maayde dow yeeduki."**



**Inuusa wurti yaasi berniwol Niineba, o don reena haa o  
ngi'a ko Allah wadata fahin. Sey Jawmiraawo Allah  
fudni lekki e haako gomoodi. Ndu mawni law, ngadani  
Inuusa dowdi, mabbini mo naange nyalaade maajum fuu.**



**Jaŋgo man, Allah leli ngilngu ngu mbari lekki  
kin. Nden Allah umri heendu wulndu,  
semmbidndu, dum wuli Inuusa haa o numi o  
maayoto. Du'um fuu beddani Inuusa tikkere.**



**Nden Allah yami Inuusa, "A woodi haanere  
a tikka na? A yurmini lekki ki a torraaki  
ngam maaki, a mawninaay ki. Ki  
wangi nder jemmaare woore, ki  
halki boo nder jemmaare woore.  
Ngam dume mi**

**yurminta Niineba,  
berniwol mangol  
ngo'ol, e yimbe  
maari ujineeje?"**

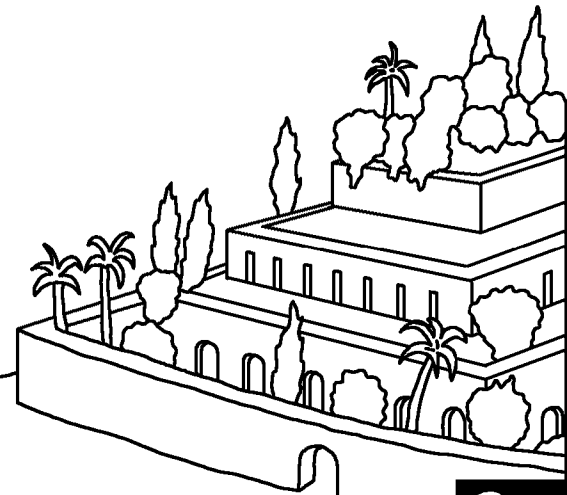
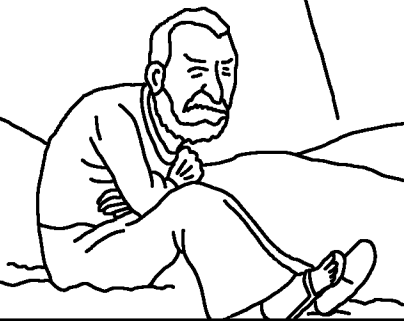

**Inuusa e Liingu Mawndu**

**Tariya ha nder Wolde Allah, Deftere,**

**tawama ha nder**

**Inuusa**

**"Damugal Wolde Mada don hokka jayngol."**

**Jaabura 119:130**





**Timminol**



26

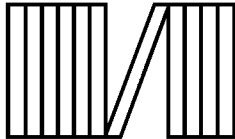

60



**Tariya Deftere ndu don wolwina amin do Allah  
amin je boddo je taggi amin e je yidi ha en aanda Mo.**

**Allah aandi min ngadi kujeji kalludum, je O ewnatta hakke.  
Eltare aybe dum wade, ama Allah yidi ma be gonga e O nelli  
no Biddo mako je gooto, Yesu, ha o maya do Gafangal e be elta  
Mo ngam aybe mada, Nden Yesu finni nder wade e dilli ha saare  
ha asaman! To a don nuddina Yesu e emmi mo ngam ha O  
yaffa hakkeji mada, O wadan dum. O waran e O wondan  
be ma jonta, e a wondan be Mako ha abada.**

**To a tammi dum gonga, Yeccu do ha Allah:  
Yesu am, mi don nuddina an woni Allah, e lati neddo ngam  
mayugo ngam hakkeji am, jonta A don yedda fahin. Useini nastu  
ha nde jonde am e yafanam hakkeji am, ngam ha jonde am sanja  
jonta, e yende feere mi wonda be ma ha abada. Wallam ngam  
hedditugo Ma e yedda ngam Ma bana biddo Ma. Amina.**

**Jaangu Deftere e ngewtu be Allah tum tum! Yohonna 3:16**

