

Littafi mai Tsarki na yara
Ke gabatar da

Yona da
babban kifi



Wanda ya Rubuta: Edward Hughes

**Mai Zane: Jonathan Hay
Alastair Paterson**

Mai niyyan daukan nauyi: Mary-Anne S.

Fassarawa: Bible Society Nigeria

**Wanda ya Wallafa: Bible for Children
www.M1914.org**

©2024 Bible for Children, Inc.

**Zaku iya kofan wanna labarin ku wallafa idan
har ba zaku sayar da shi.**



**Shekarun baya da dama, an yi wani
mutum mai suna Yona a kasar Isra'ila.**

**Wata rana Allah ya gaya masa ya
tafi Nineba, birni mafi
girma da iko a dukan
duniya a
lokacin.**

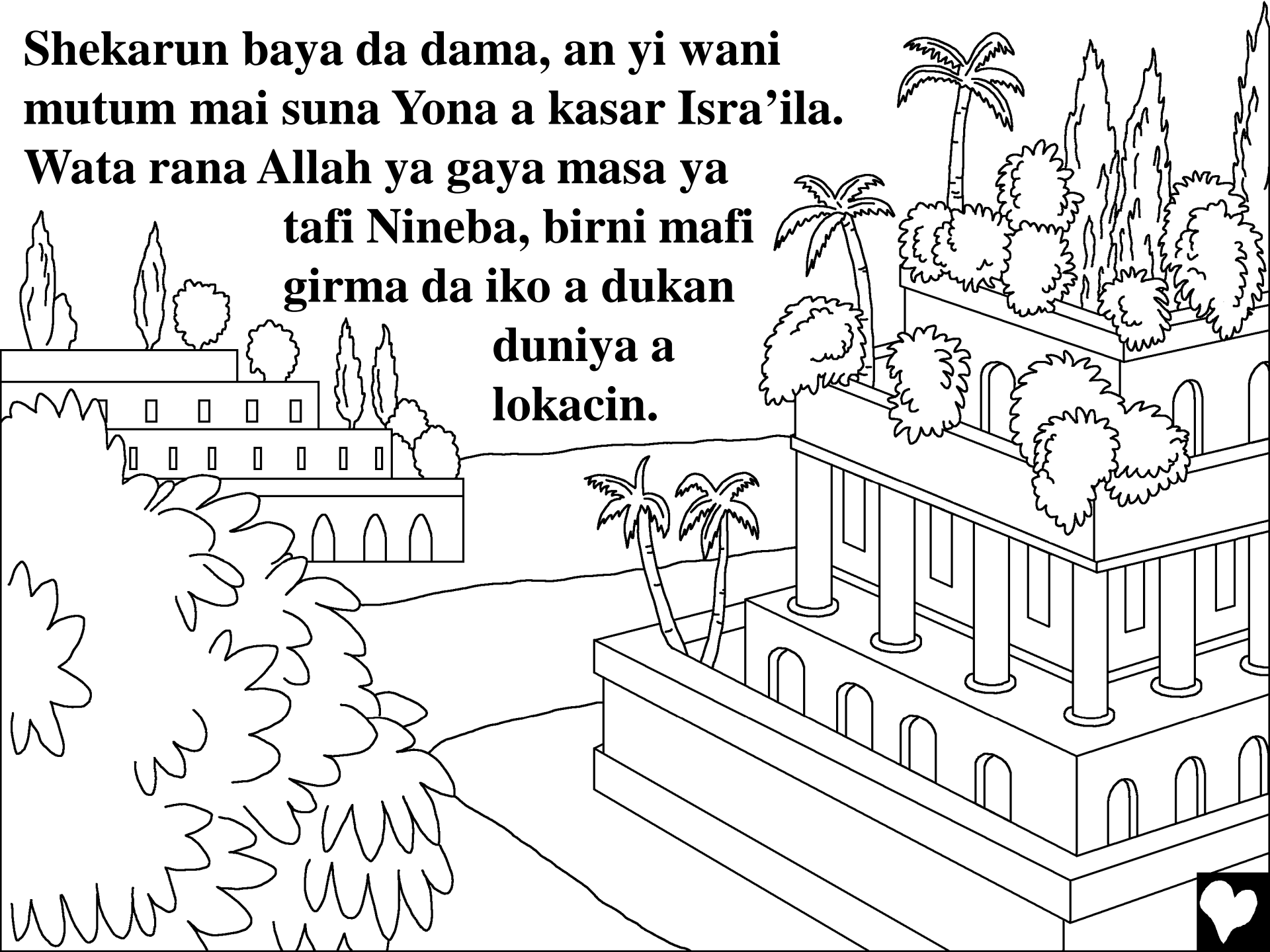

Yona zai je garin don ya ja mutanen kunne cewa Allah yana sane da muguntansu.



**Yona ya yi wa Allah rashin biyayya!
Maimako ya je Nineba, Yona ya
shiga jirgin ruwa ya kama hanya
zuwa wani wuri dabam zuwa gari
mai suna Tarshish.**



**Ubangiji Allah ya aiko da babbam iska a tekun. Sai aka
yi babban hadari! Masu tukan jirgin suka ji tsoro
watakila jirgin ruwan zai kakkarye ya lume cikin tekun.**

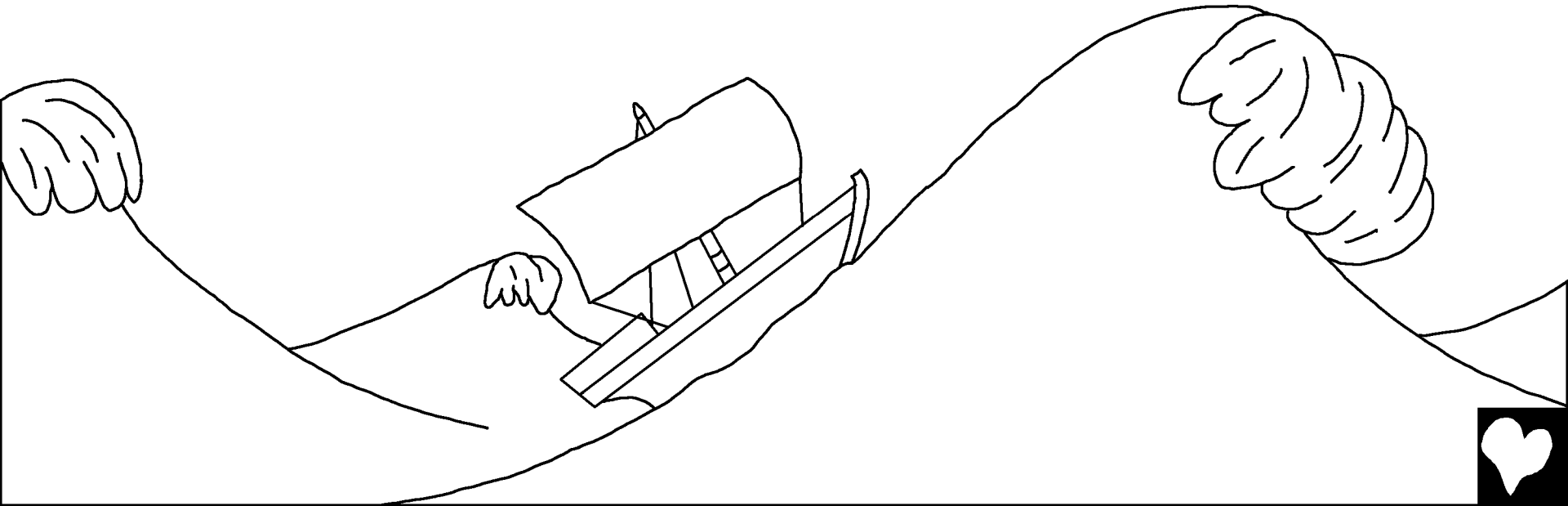

Hadarin ya yi ta karuwa. Cikin tsoro mai tsanani, masu jirgin suka yi addu'a ga allolinsu suka ciccire kaya suna jefar wa a tekun domin su rage nauyin kaya a cikin jirgin. Amma yin haka bai taimaka ba.

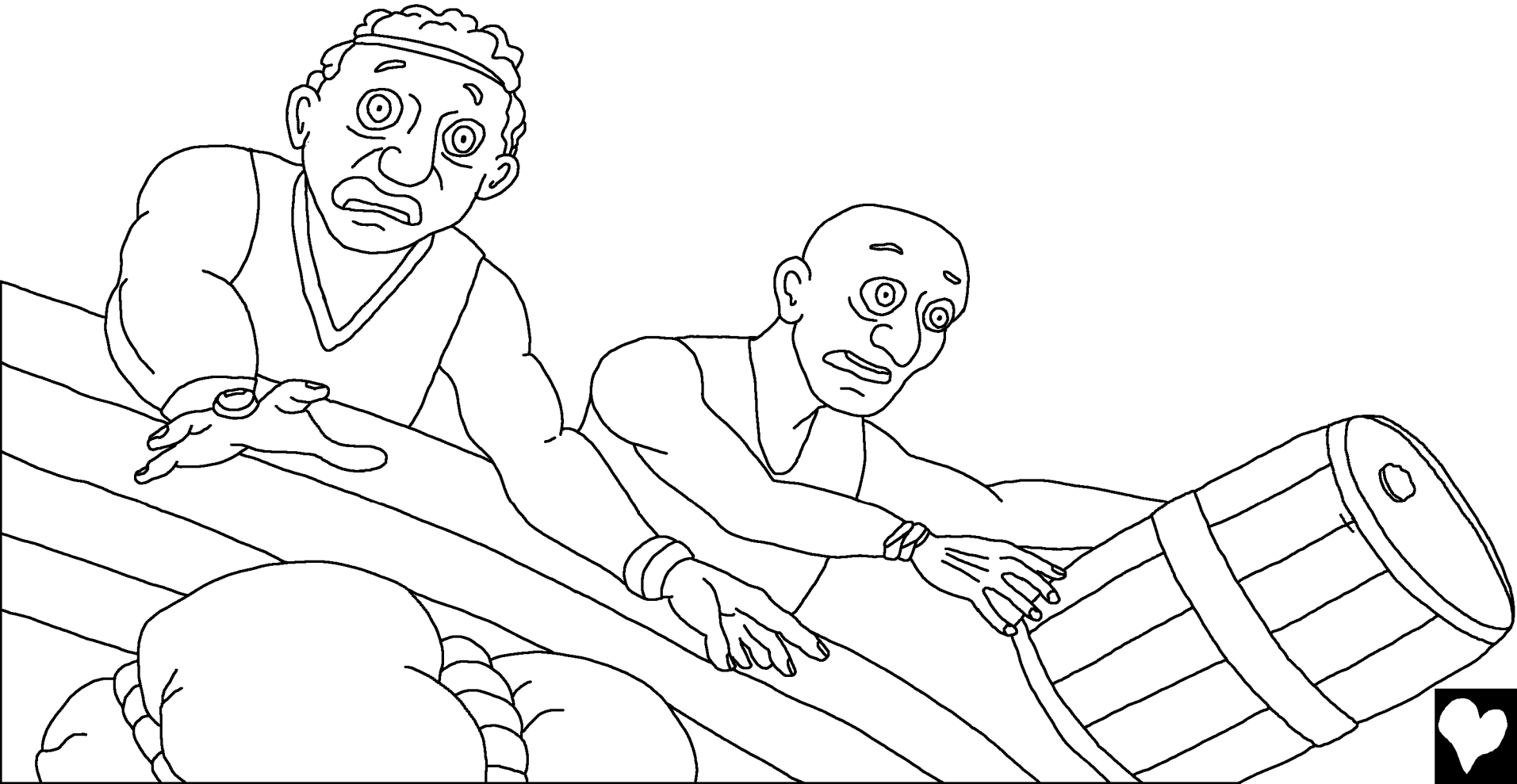

**Yona ne kadai a cikin jirgin wanda ba ya addu'a.
Maimmaiko, yana kwanciye a cikin jirgin, yana barci
mai zurfi. Shugaban masu tukan jirgin ya same shi.
“Mene ne kake yi kana barci? Tashi! Ka yi addu'a ga
Allahnla! Watakila Allah zai tuna
da mu, don kada mu halaka.”**

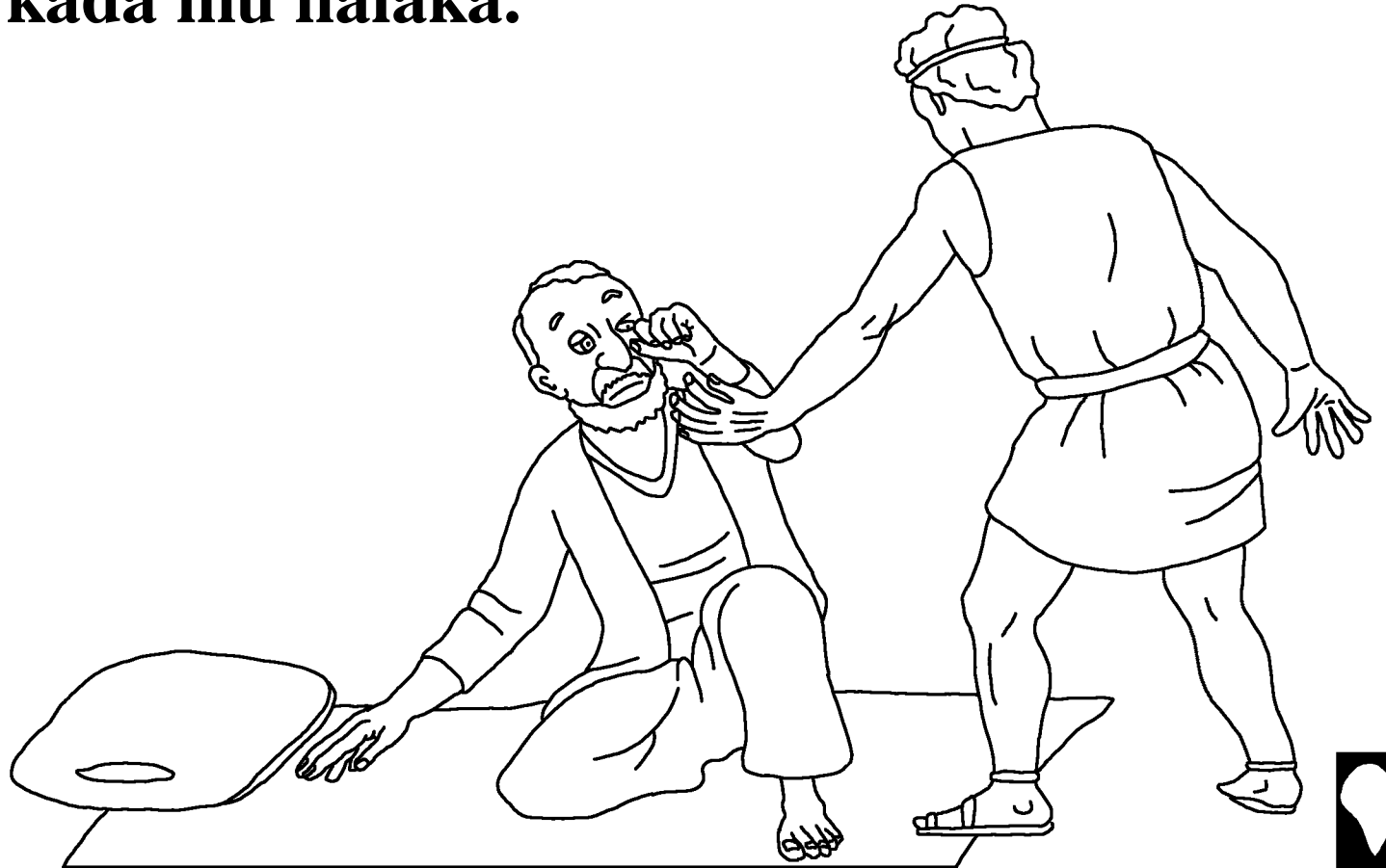

Sai suka gane cewa damuwansu yana da dangantaka da Yona. Sai ya gaya musu cewa yana gudu ne daga wurin UBANGIJI. Sai suka tambaya, “Mene ne za mu yi da kai, domin tekun ya kwanta domin mu?” “Ku dauke ni sama sai ku jefa ni a cikin tekun,” Yona ya amsa.

“Gama na tabbata saboda ni ne wannan babban hadarin ya zo muku.”

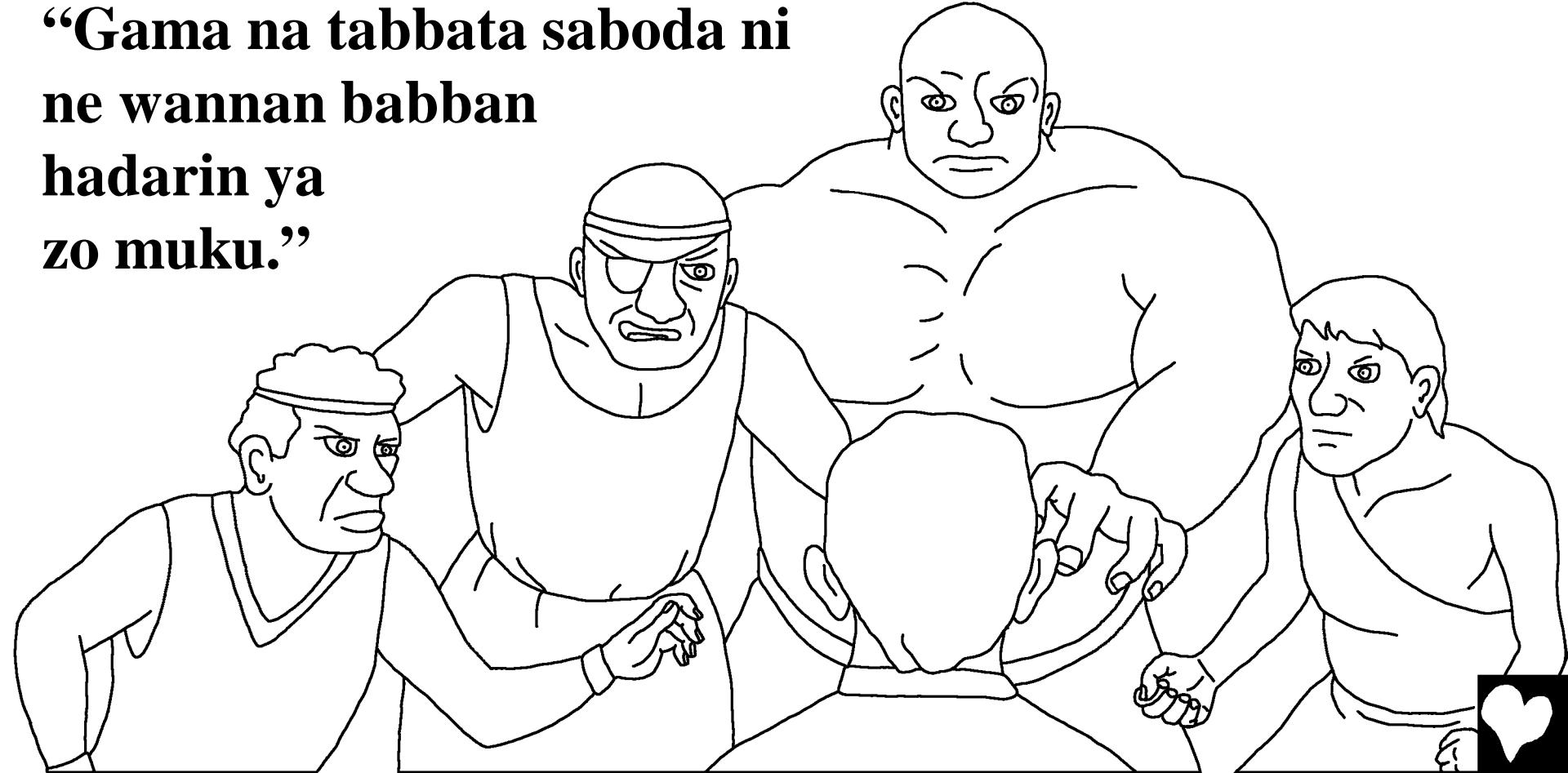

**Masu jirgin ruwan
ba su so su jefar da
Yona a cikin tekun
ba. Sai suka yi
kokari su kai jirgin a
bakin teku. Amma
ba su iya ba. Akwai
wani abu daya tak
wanda za su yi!**

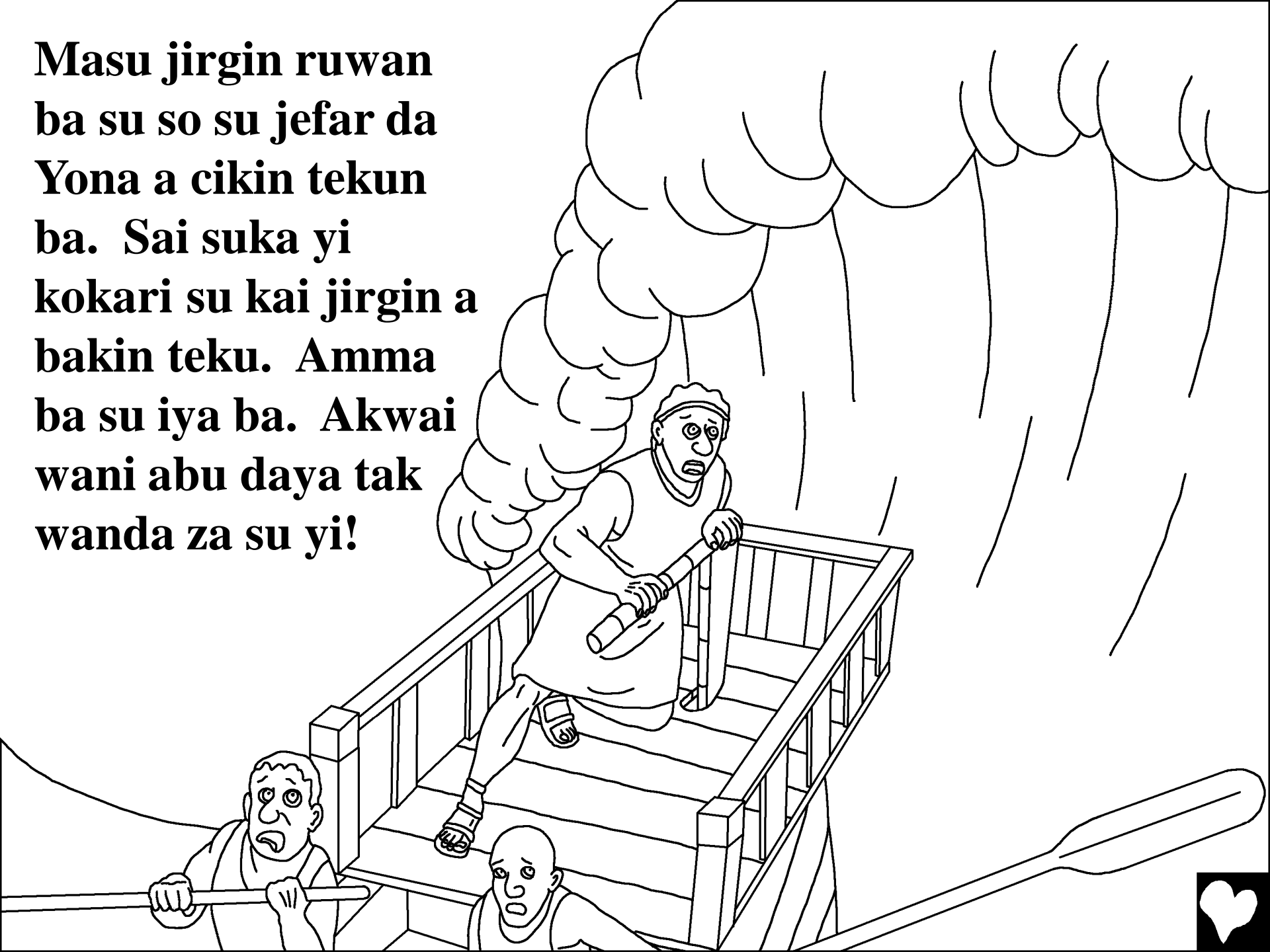

**Bayan yin addu'an neman
yafewa, sai masu
tukan jirgin
suka daga
Yona sama
suka jefar da
shi a gefen dayan.
Yayinda Yona yana
lumewa a cikin ruwan,
sai tekun ya kwanta
tsit sai isakar ta daina.**

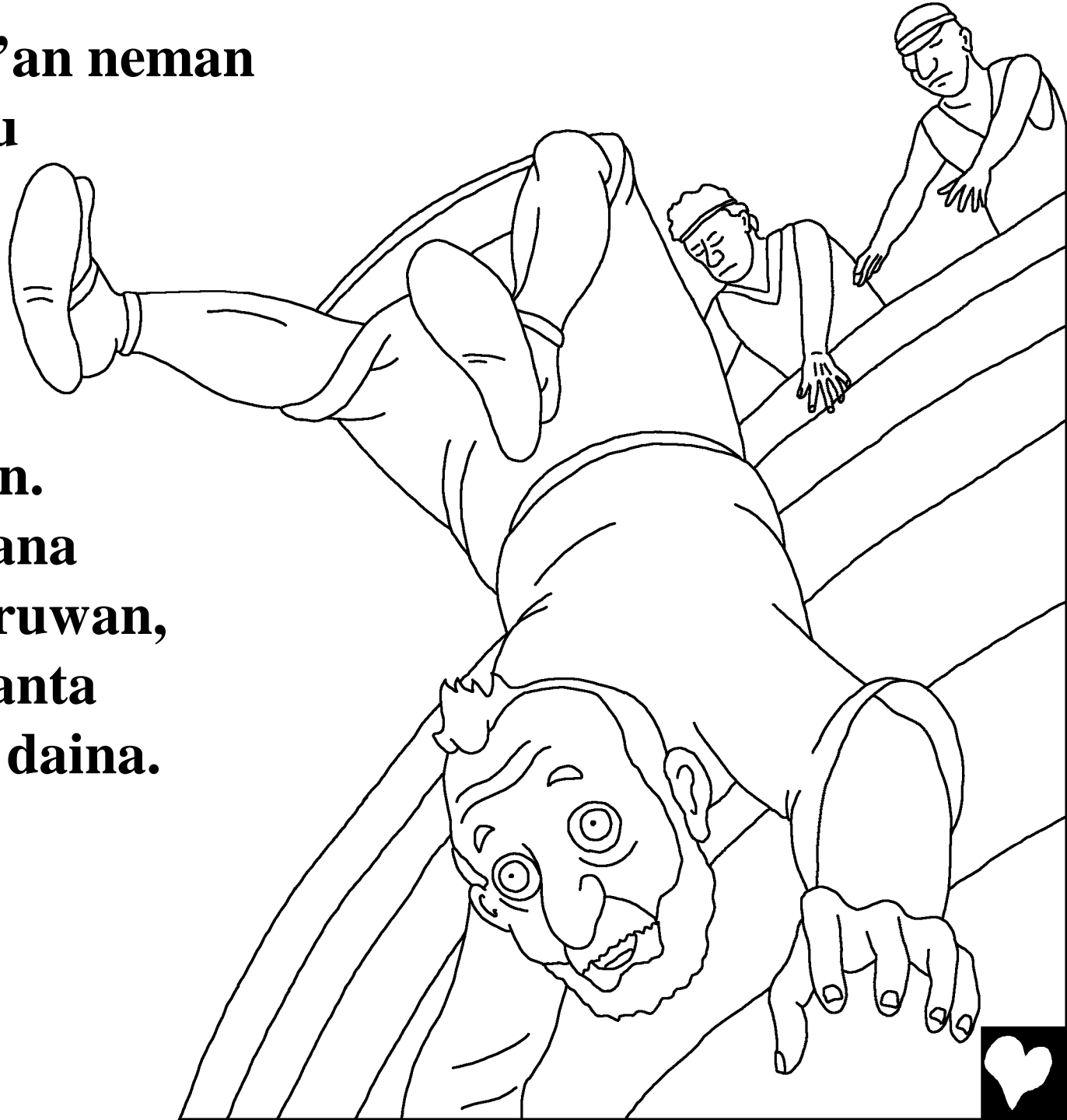

**Yadda yanayin ya
canja nan da nan
ya ba wa masu
tukin jirgin
tsoro fiye
da hadarin
da suka fuskanta.**

**Babu shakka, sun gane
cewa Allah ne kadai wanda
zai iya aikata wannan.
Cikin tsoro da mamaki,
sai suka yi wa
Allah sujada.**



**Amma dai, wannan dan
aika marar biyayya ya
sami abin ba da
mamaki. Cikin
lumewa a cikin ruwan
babu taimako, Yona ya
sani cewa babu abin
da zai iya cece shi daga
mutuwa na ruwa.
Da ya sha ruwa har
mutuwa, kuma – amma
Allah yana da shiri
dabam.**

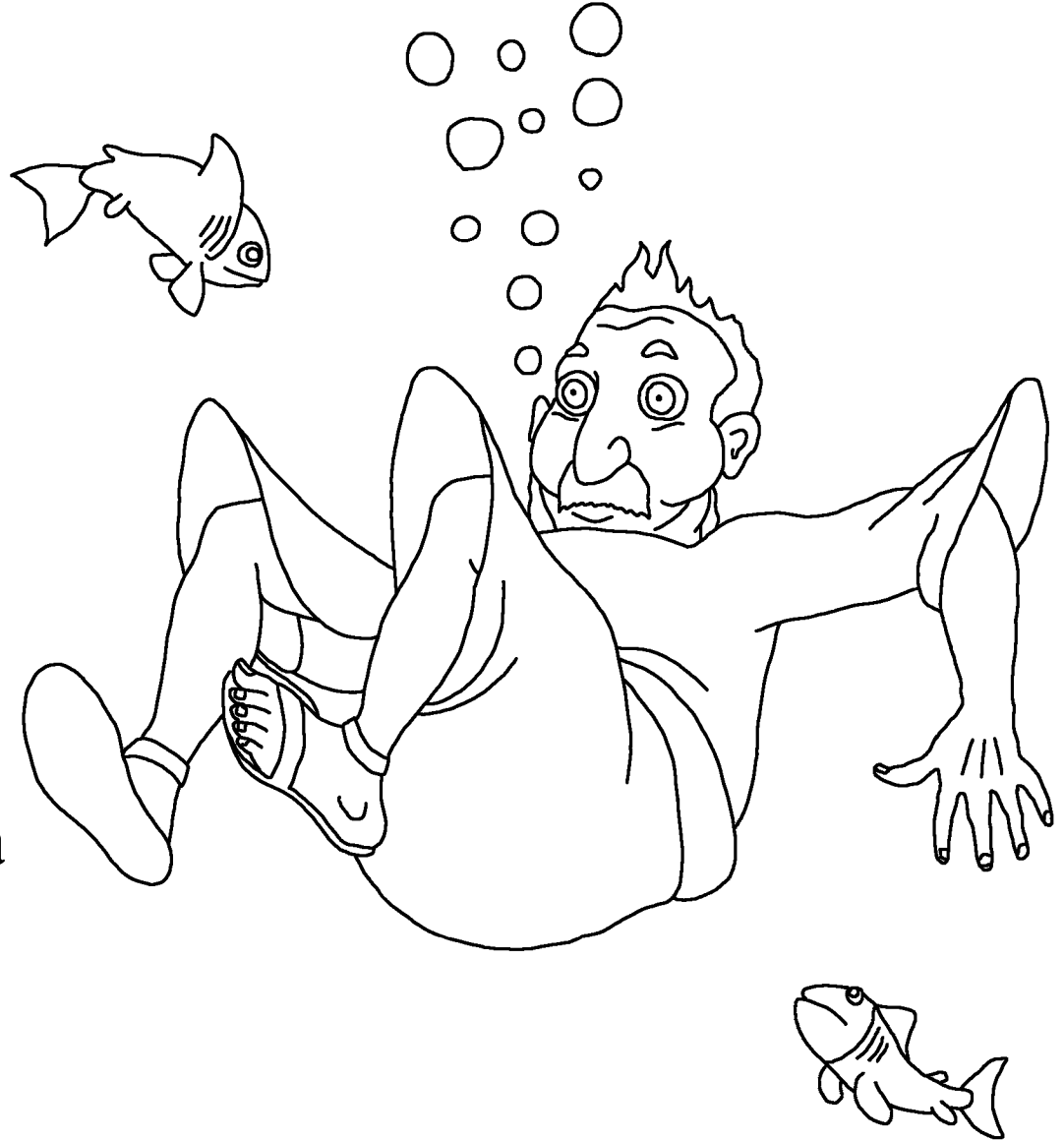

UBANGIJI ya shirya wani babban kifidon ya hadiye Yona. Kifin ya zo daidai lokaci! Kurbawa sau daya kawai, Yona ya bar teku zuwa ciki cikin kifi. Yona ya zauna a ciki cikin kifi na kwana uku. Ya sami isashen lokacin tunani da addu'a.



Bayan kwana uku, Yona akarshe ya yi alkawari zai yi biyayya ga Allah. Nan take, Allah ya yi magana da kifin, sai ya yi aman Yona a bakin tekun.

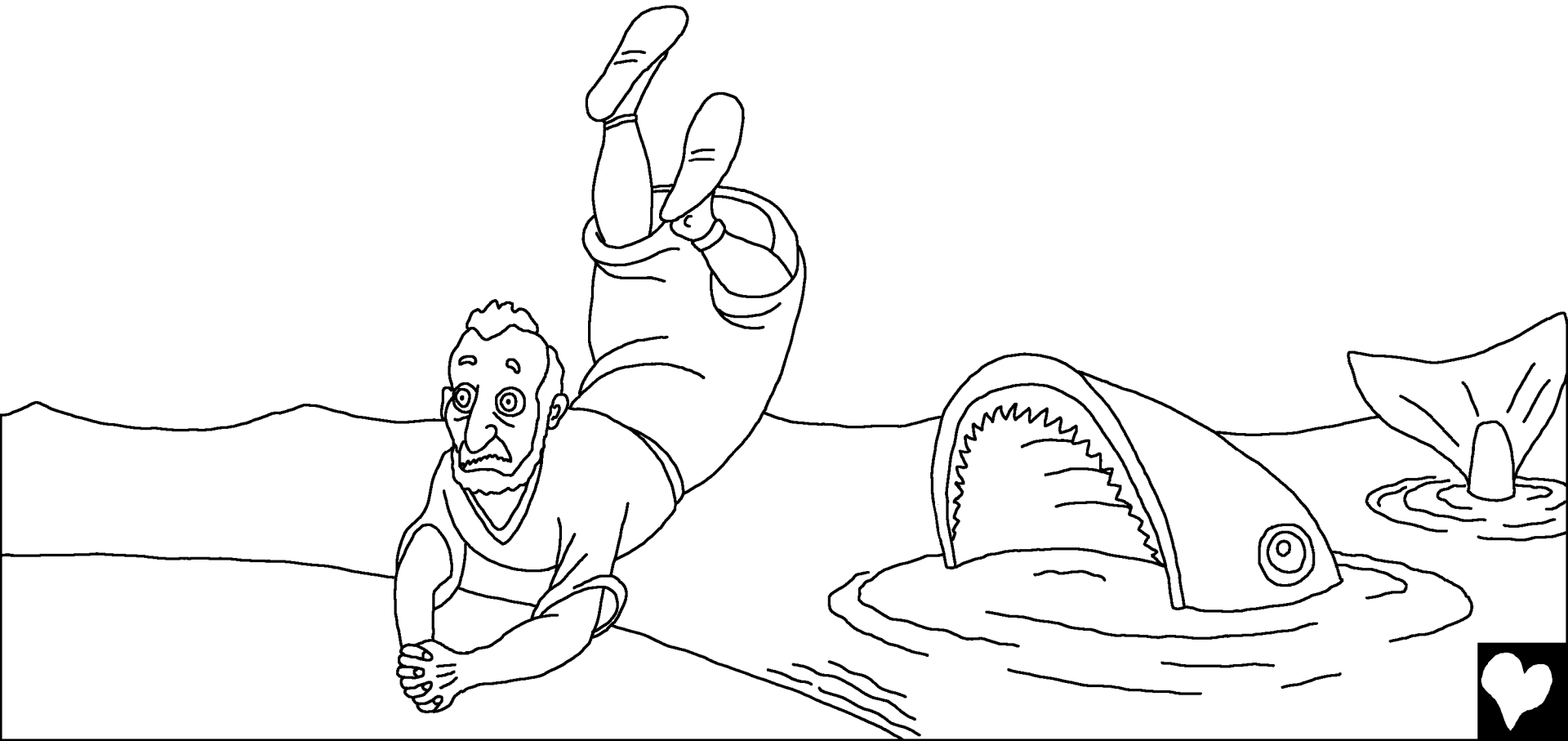

**Sau daya kuma, Allah ya gaya wa Yona ya tafi
Nineba ya yi wa'azin kalmar Allah. Wannan karon,
Yona ya tafi! Yona ya shiga birnin, yana ihu, “A
kwana arba'in, za a ci nasara kan Nineba.”**



Mutanen Nineba suka ba da gaskiya ga kalmar Allah. Suka yi azumi, suka rufe rigunan nunan bakin ciki don su nuna cewa sun tuba daga zunubansu. Ko sarki ma ya kaskantar da kansa a gaban Allah. Ya auka daga kursiyinsa, ya saka rigunan nunan bakin ciki, ya zauna a cikin toka. Ya ba da umurni kowa ya tuba daga mugaye halinsa da mugunta, sai kowa ya yi addu'a don UBANGIJI ya yafe su.

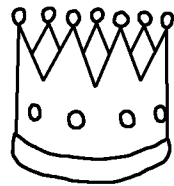

Allah kuwa ya yafe su! Lallai rana farin ciki mai yawa ne a birnin Nineba sa'ad da mutanen suka gane cewa Allah

ya riga ya yafe musu zunubansu. ...Amma mutum daya ya kasance da bakin ciki mai yawa. Yona!



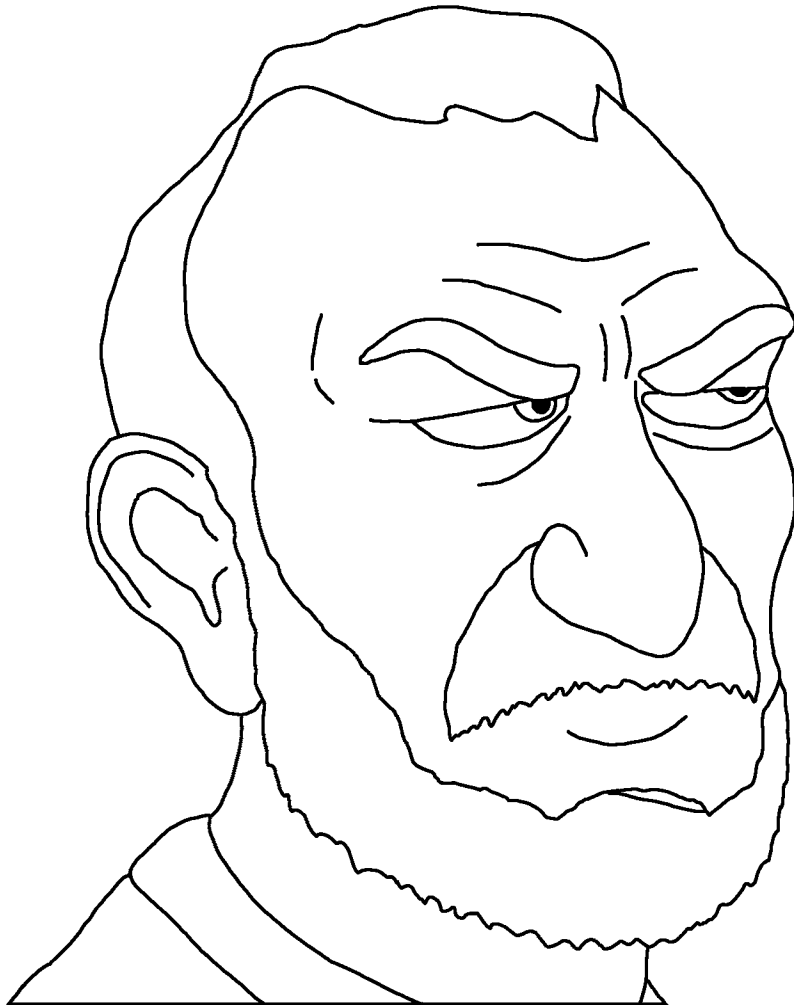

**Don me Yona ya yi fushi?
Ya ce wa Allah, “Na sani
cewa kai Allah mai alheri
da jinkai ne, mai jinkirin
fushi, mai yawan kirki.”
Wato, Yona ya sani cewa
kullum Allah yana yafe wa
wadanda suka tuba daga
zunubansu suka kuma yi
biyayya ga Kalmar Allah.
Ya nuna kamar Yona bai so
mutanen Nineba ba. Bai so
a yafe musu zunubansu ba.**



Yona ya yi fushi da Allah sosai har ya ce, “Dauki raina daga garen; gama mutuwa ta fi mini kyau fiye da rai.”



**Yona ya zauna a bayan
garin, yana jira ya ga
abin da Allah zai yi nan
gaba. Ubangiji Allah ya
shirya wani itace mai
manyen ganye. Ya yi
girma da sauri-sauri,
Yona ya zauna a inuwarsa
daga zafin rana duka yini.**



Washegari, Allah ya aika da kwari, wanda ya cinye itacen. Sa'an nan Ubangiji ya shirya isak mai zafi mai karfi wanda ya jiji wa Yona har yana gani kamar zai mutu. Duka wannan ya kara ba wa Yona fushi.



Sai Ubangiji ya ce wa Yona, “Ko kana da ‘yanci ka yi fushi? Ka tausaya wa itacen inabin da ba ka yi aiki a kansa ko ka sa ya yi girma ba. Ta bullo da daddare sai ta bushe da daddare.

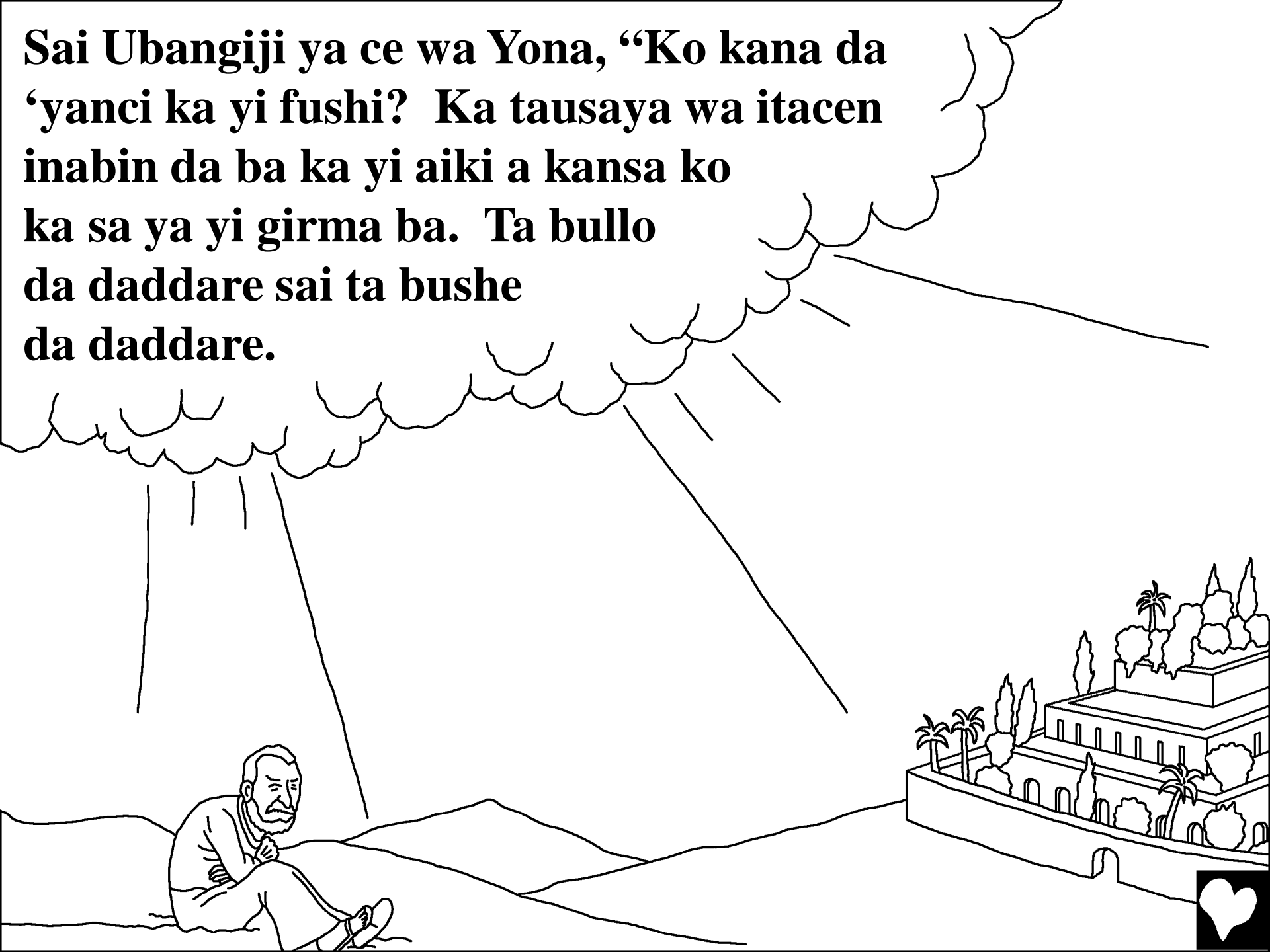

**Don me ba zan yi jinkai a kan
Nineba, wannan babban birni, da
dubun-dubban mutanenta ba?”**



Yona da babban kifi

Tahiri da ga maganar Allah, littafi mai Tsarki

a na samu a

Yona

**“Shigowar maganar ka yana baduar kawo
haske.” Zabura 119:130**



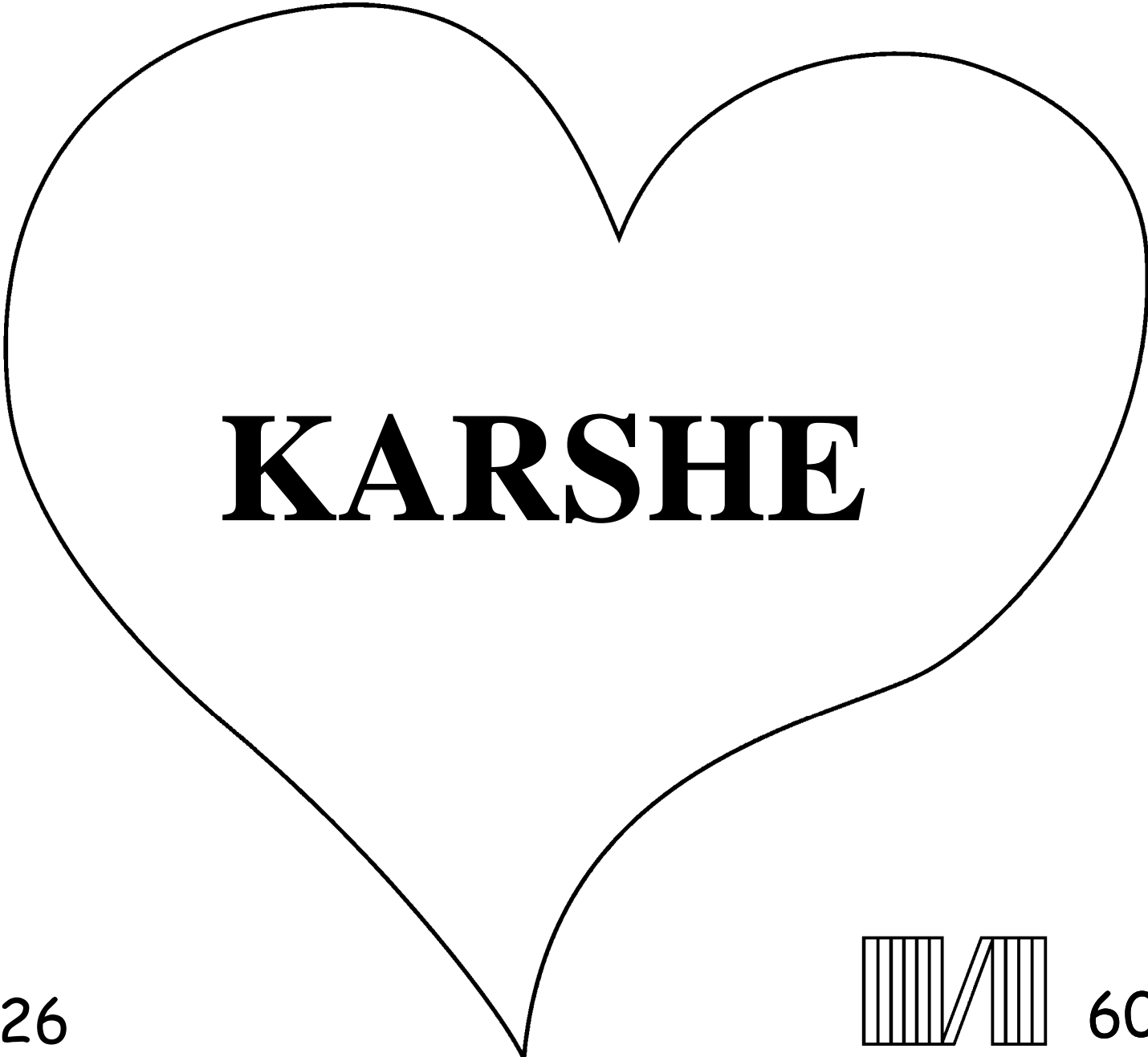

KARSHE

| 26

||||| 60



**Wanan tahiri daga littafi mai-tsarki na mana bayanin
Allah mu wanda ya halicce mu wanda yake son mu san shi.**

**Allah ya san da cewa mun yi abubuwan da ba su da kyau, wanda yake
kira zunubi. Sakamakon zunubi mutuwa ne, amma Allah ya na
kaunan mu sosai. Ya aiko da Dansa Yesu, ya mutu a kan giciye ya sha
wahala domin zunuban mu. Kuma sai Yesu ya tashi daga matattu ya
koma gida a sama. Idan ka bada gaskiya ga Yesu. Ka rokeshi gafaran
zunuban ka, zai yafe. Kuma zai zo ya zauna a cikin zuciyar
ka kaima kuma zaka zauna a zuciyar shi har abada.**

**Idan ka yadda da wannan gaskiya ne, Ka cewa Allah:
Ya Yesu, na bada gaskiya kai Allah ne, ka kuma zamu mutum don ka
mutu domin zunubi na, kuma yanzu ka tashi. Ina rokon ka, ka shiga
cikin zuciya na kuma ka yafe min zunubai na, Domin in samu sabon
rai yanzu, kuma wata rana in zauna tare da kai har abada. Ka
taimake ni in yi maka biyayya kuma in yi rayuwan da
zai gamshe ka a matsayin dan ka. Amin.**

**Ka karanta littafi mai-tsarki kuma ka yi magana da
Allah a kulla yaumin. Yahaya 3:16**

