

Ikwukwo akuko nso maka umu ntakiri
a na-egosi

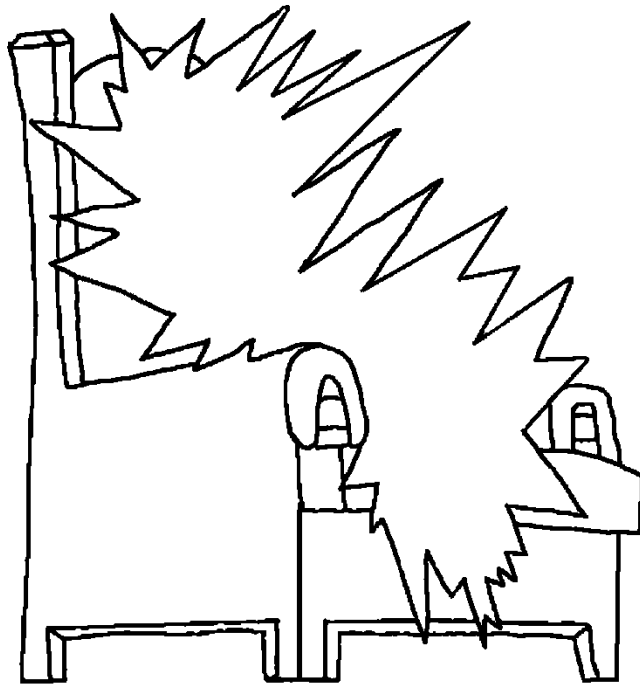

Alaeze
elugwe ebe
obibi oma
Chineke



Ode akwukwo: Edward Hughes
Onye kuziri ya: Lazarus; Alastair P.
Onye haziri ya/Onye nhazi:
Sarah S.

Onye tughariri okwu a: Ekwealor Sylvia Ujunwa
Onye biputere akwukwo: Bible for Children
www.M1914.org

BFC
PO Box 3
Winnipeg, MB R3C 2G1
Canada

©2021 Bible for Children, Inc.

Ike/ikike: i nwere ike ma obu ikike i biputa akuko a nani i gaghi ere ya ere.



Mgbe Jisos no n'elu uwa O gwara ndi umuazu maka
alaeze Chineke. "Nke O kporo ulo nna m". Na
enwere otutu ulo oma ebe ahu.

Ulo oma buru ibu nke ukwu
u. Alaeze eluigwe buru
ibu maa nma nke
ukwu u karia
ulo elu uwa.

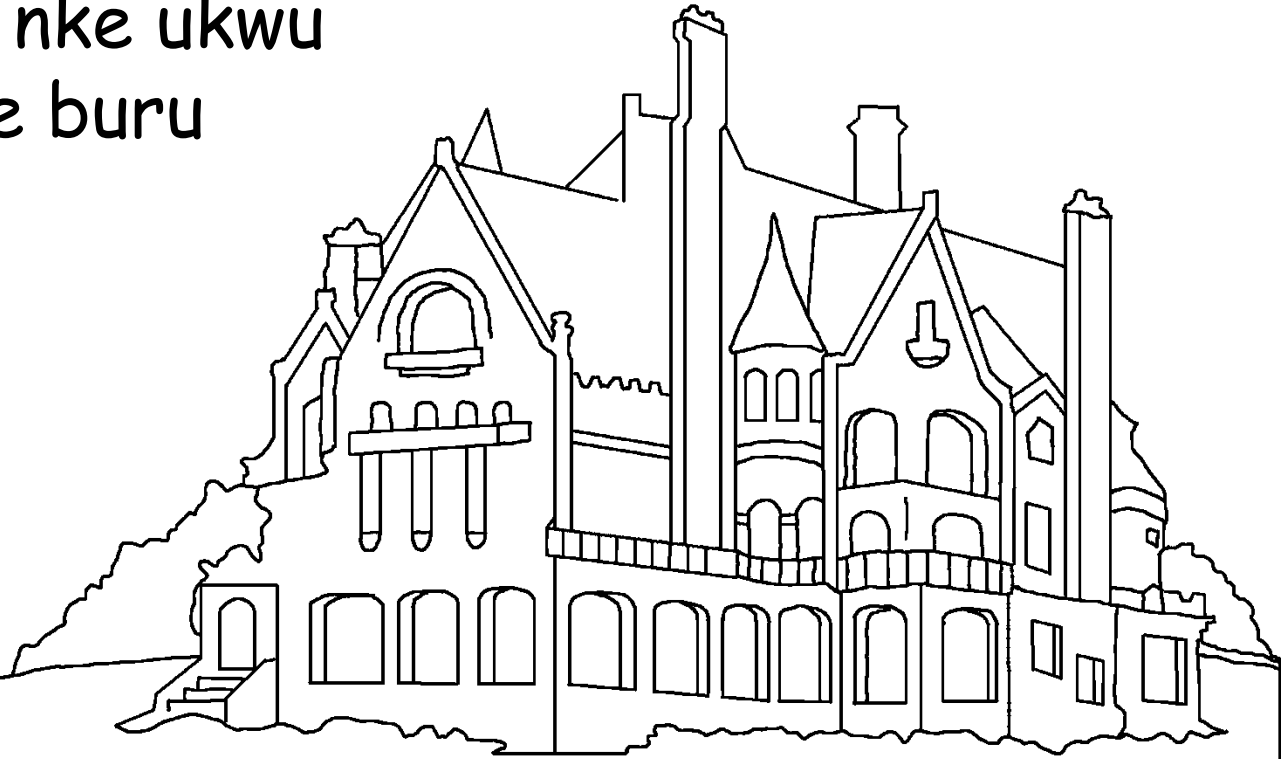

Jisos gwara ndi umuazu ya si, "a na m ala n'ulo nna m ka m ga doziere unu ebe unu. O buru na m ga dozicha ebe ahu, a ga m abiaghachi ozo bia kporo unu n'onwe m".

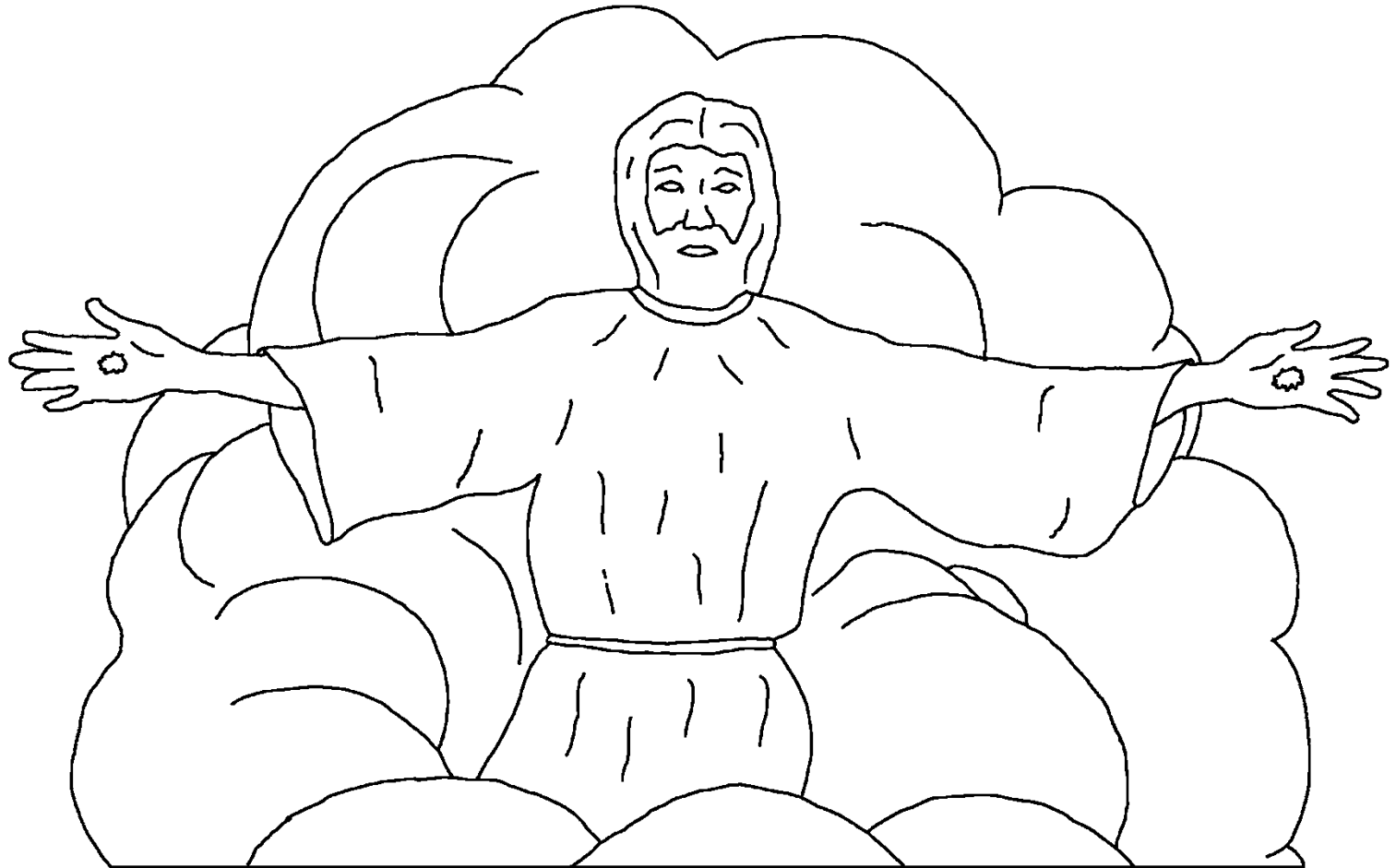

Jisos lahachiri alaeze eluigwe, ka O siri n'onwu bilie. Di ka umuazu noo n'ele anya, Jisos lagoro eluigwe, anwuru eluigwe wee kpuchie Ya ndi umuazu ya enweghikwa ike ihu ya.

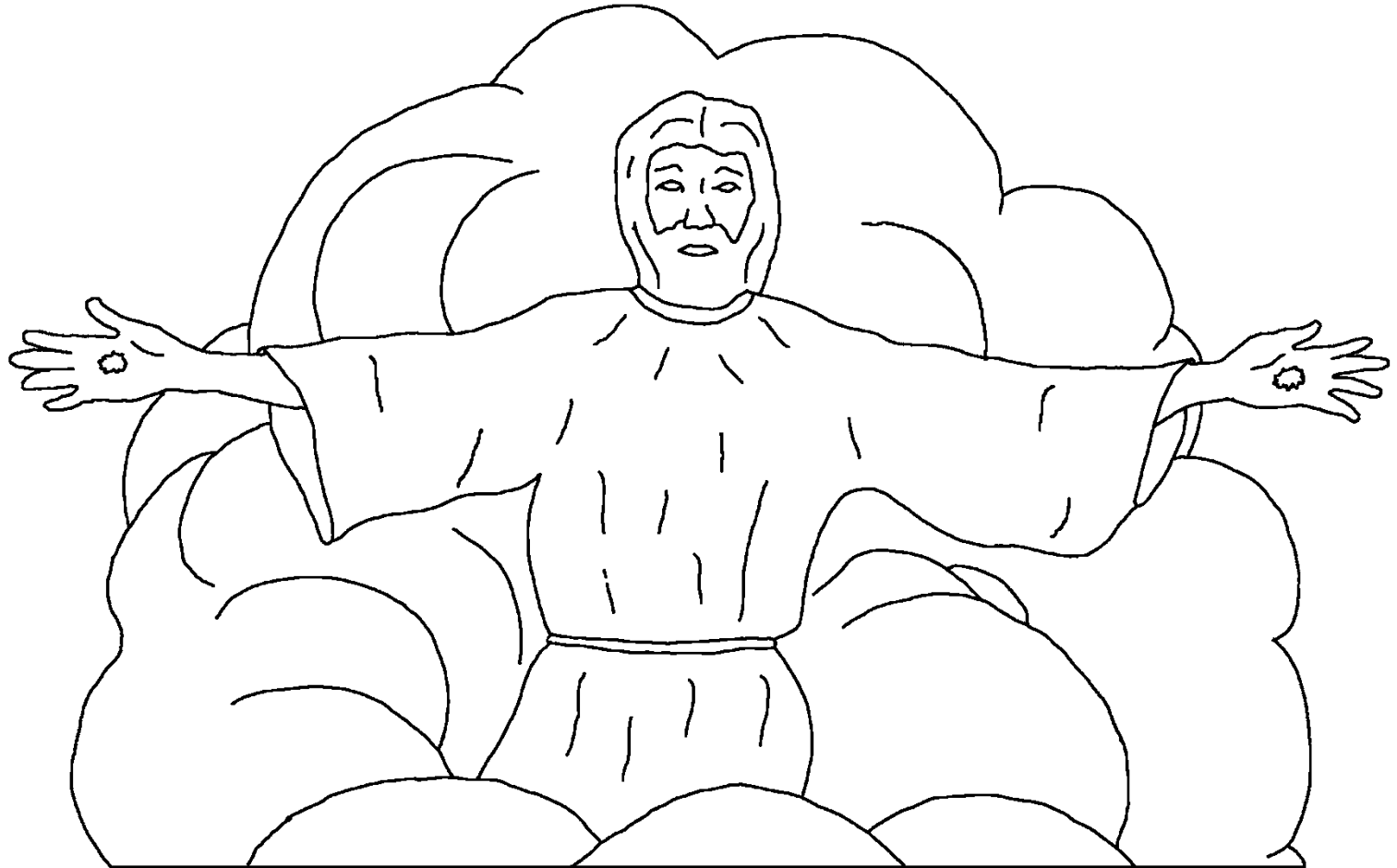

Site na mgbe ahu, ndi n'eso nzokwu Jisos ka
n'echetakwa nkwa Jisos kwere ha na O ga abiaghachi
oso bia kporo ndi nke Ya. Jisos kwuru na O ga
abia mgbe a na atuwaghi anya ya. Mana
kedu maka ndi kwere na Ya nwuru
nu tupu rue mgbe O ga bia?

Akwukwo nso kwuru na ha
ga alakwuru Ya. O dighi
anu ahu o bula ga ahu
Chineke nani ma
onye ahu onwuru



**NNORITA NKE
MMADU NA
JISOS**

ma obu gbanwe yiwe
anwu anwu.



Akwukwo mkpuhe, nke bu akwukwo ikpeazu n'ime
akwukwo nso, gwara anyi etu alaeze eligwe siri maa
nma di egwu. Ihe juru mmadu anya bu na uzo puru

iche, eluigwe bu alaeze
Chineke. N'ezie Chineke
nozuru ebe nile
mana oche eze
di na-alaeze
eluigwe.

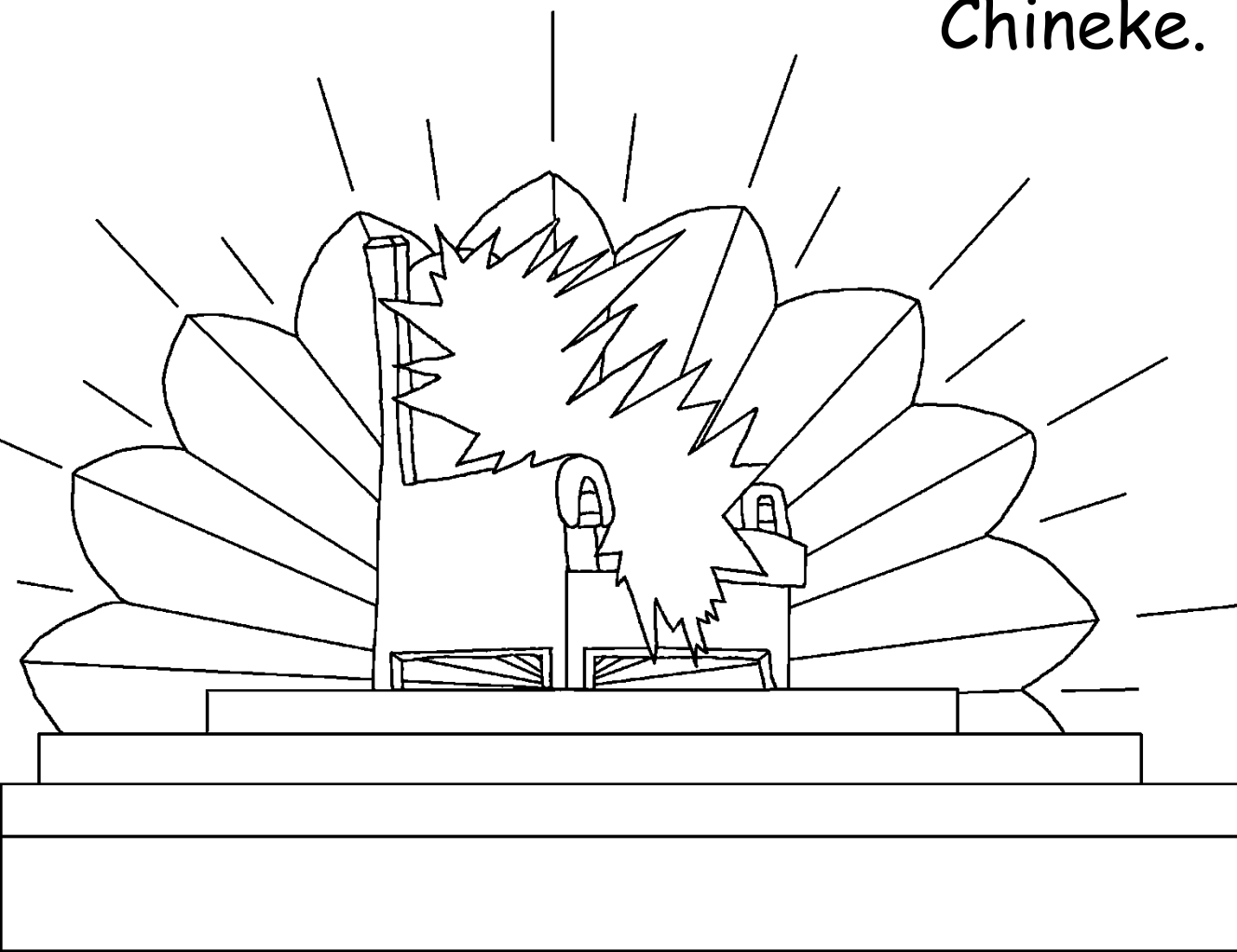

Ndi mmuo oma/mmuo ozi na kwa ndi nso nile no
n'eluigwe na akporo Chineke isiala.

Otu a kwa ka ndi nile kwenyere
na Chineke nile nwuru anwu ma
gaa eluigwe ji kwa akpo isiala
enye Chineke. Ha na
agu kwa egwu
di iche iche
wee n'enye
Chineke
otito mgbe
nile.

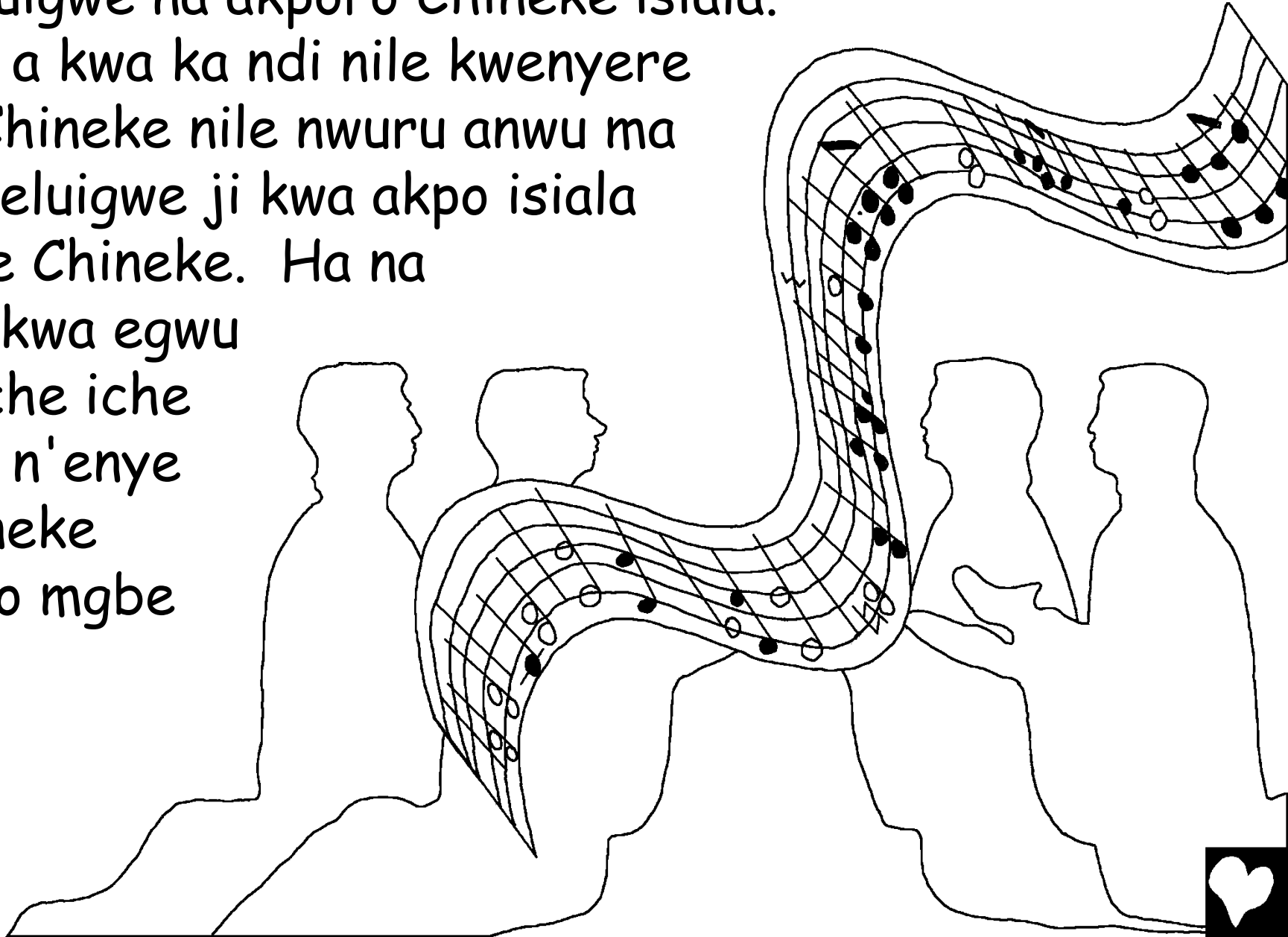

Mkpuru okwu ndi a bu ufodu mkpuru
okwu eweputara n'ime egwu di iche
iche ndi nso na agu: I di ebube
gi onye jiri obara gi di oke onu
ahia wee kpoghachite mba na
obodo nile n'ebe Chineke
noo, mee anyi
ndi eze na
kwa ndi ozi
Chineke.
(Akwukwo
mkpuhe
5:9)



Akwukwo ikpeazu n'ime akwukwo nso kowara eluigwe dika "Obodo ohuru Jeruselem". O buru ibu nke ukwu u bia nwekwa mgbochi n'ezi ya. Emewere ihe mgbochi ahu na okwute mara nma ma di oke onu ahia, na kwa egbuke egbuke.

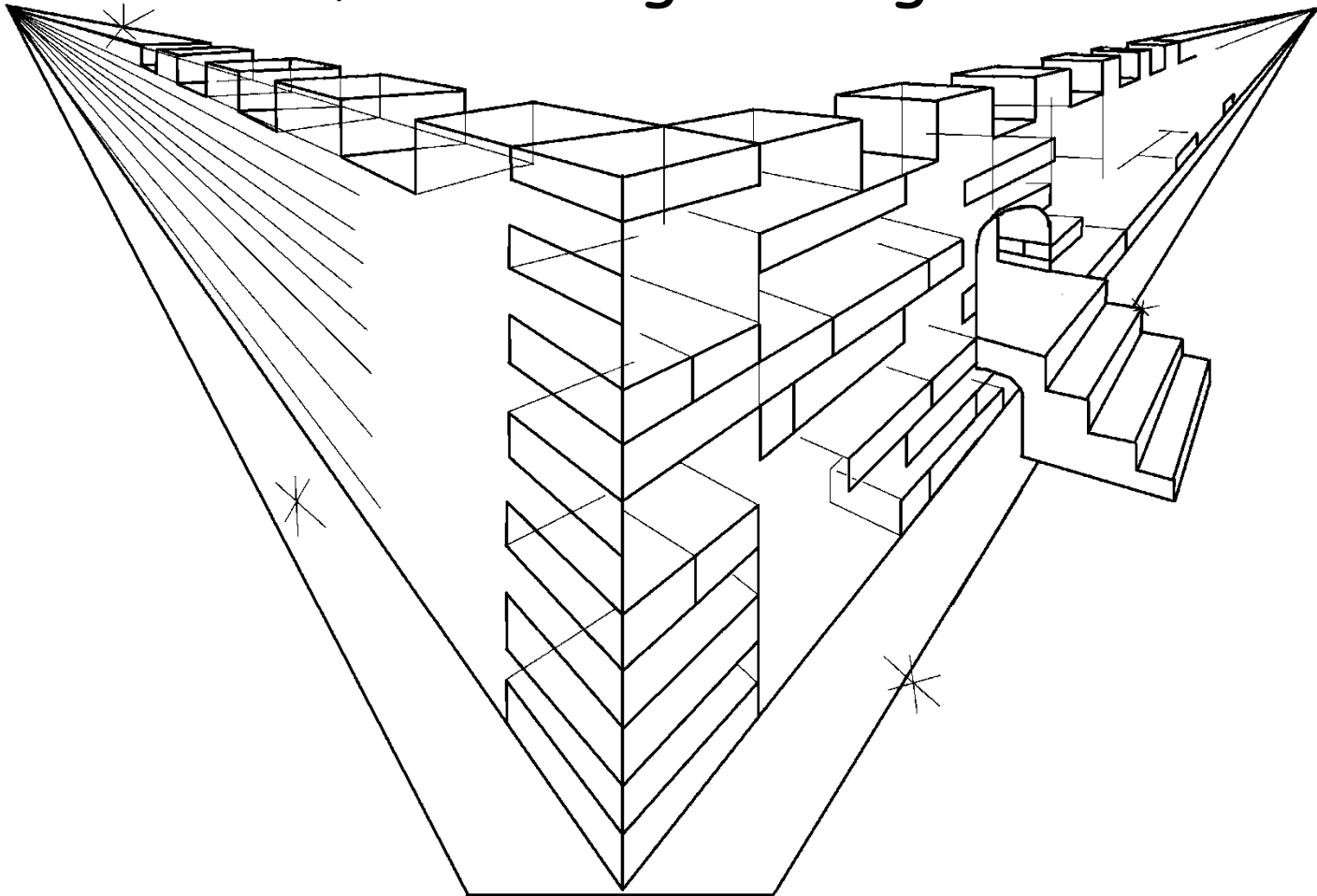

Ejiri ola edo na ihe okwute nile mara nma ma dikwa oke onu ahia na egbuke egbuke ka enyo wee choo ya nma. Ejiri okwute oma bu pearl wee gbaa ogige onu uzo ama.

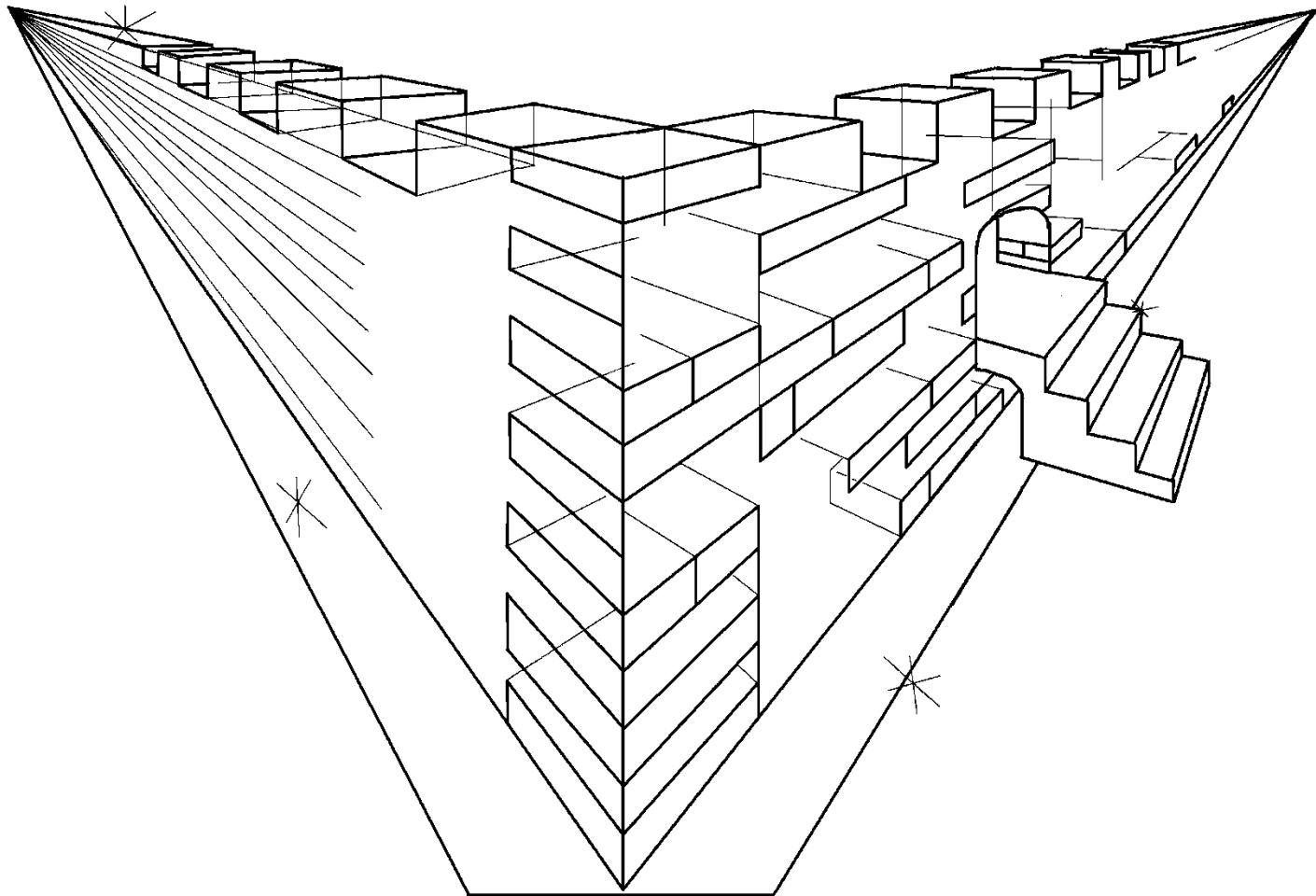

Nnukwu onu uzo ama eji okwute oma ndi a
gbaa ogige adighi emechi emechi. Bia ka anyi
banye n'ime obodo ma legharia anya ...Chei! alaeze
eligwe mara nnukwu nma n'ime ya. E ji ola edo nke

n'egbuke egbuke ka
enyo wee choo
ama na uzo
ama alaeze
elugwe nma.

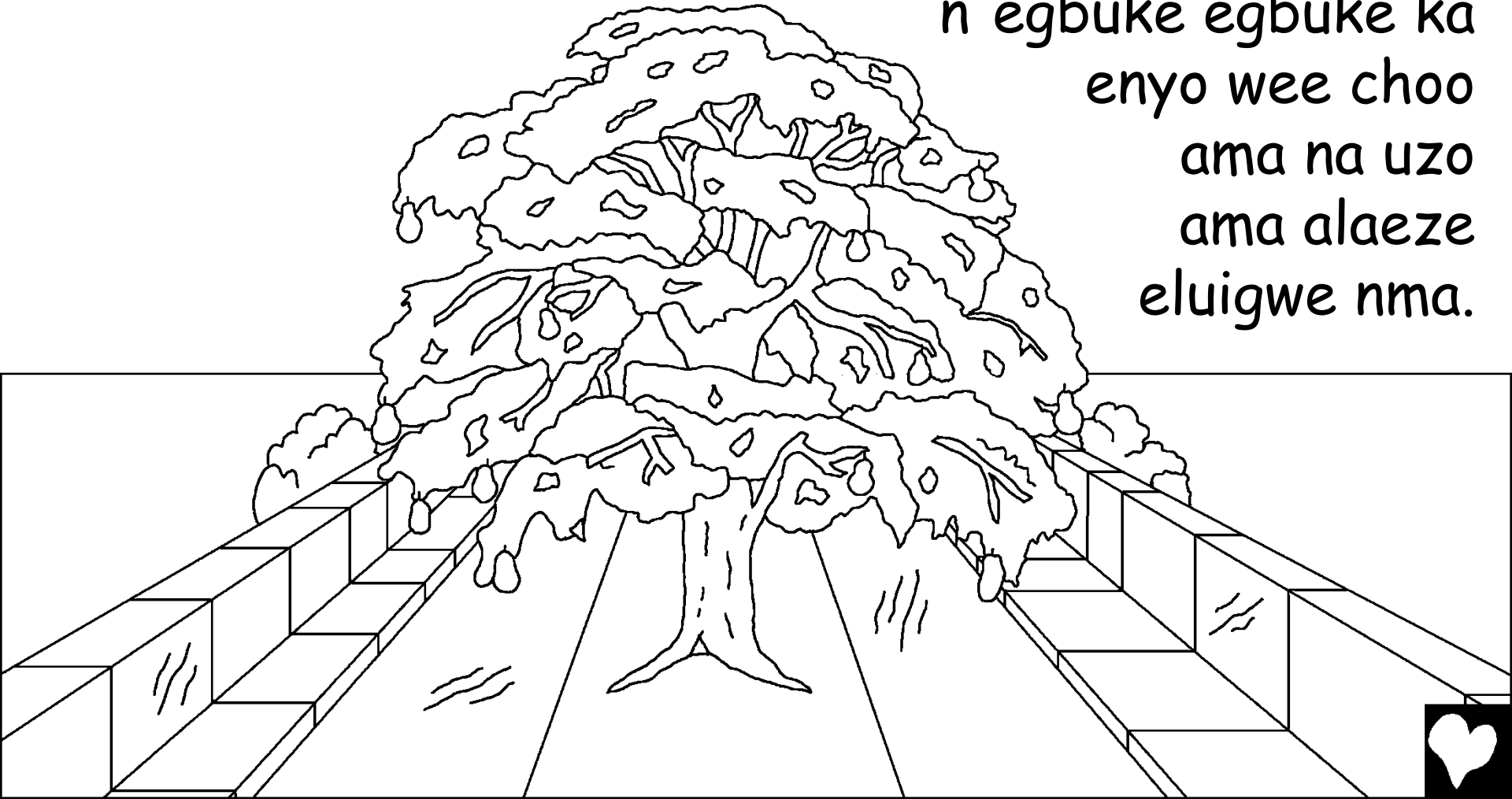

Nnukwu mmiri nke ndu sikwa n'ocheeze Chineke na-aputa. N'akuku mmiri a ka enwere osisi nke ndu bu nke mbu ahuru ala Eden. Osis nke ndu a puru iche. O na amiputa mkpuru osisi iri na abuo di iche kwa onwa. Akwukwo ahihia osisi ndu a bu maka ogwugwo mba di iche iche.

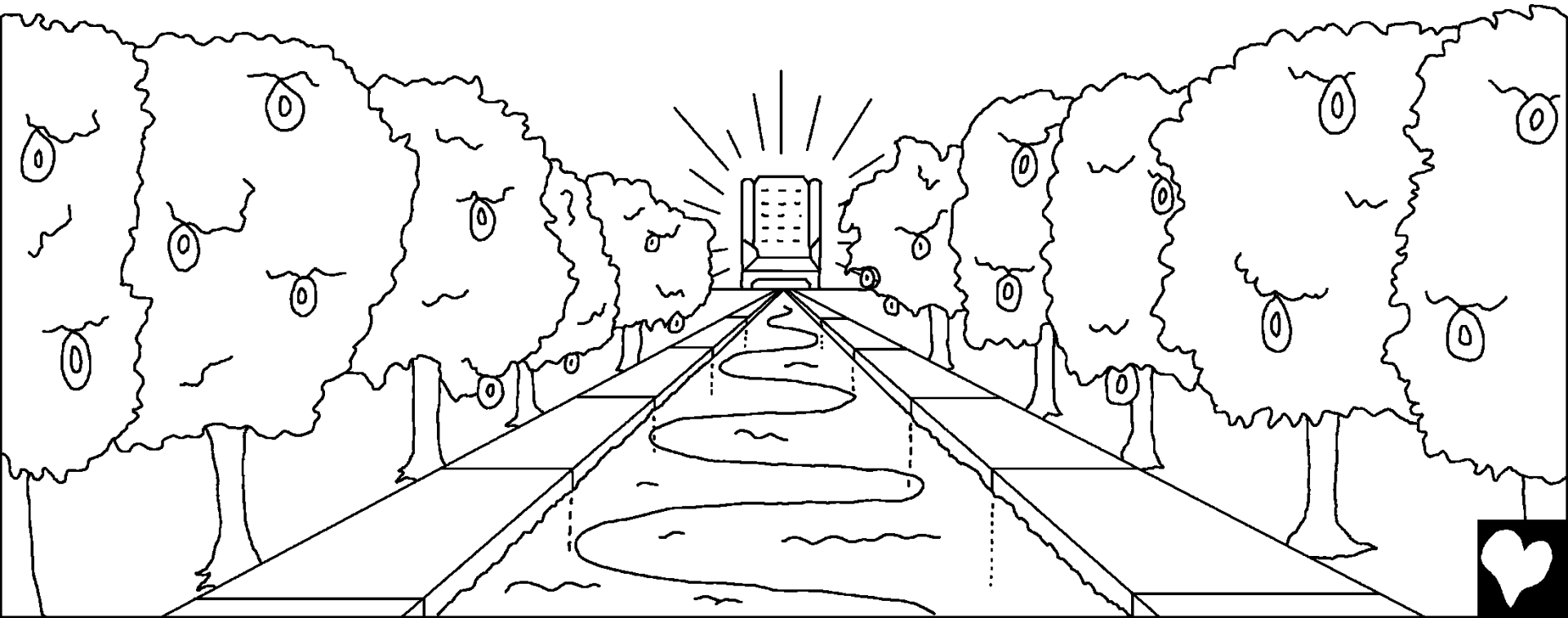

Eluigwe achoghi anwu ma o bu onwa o bula i ji were
hu uzo. Ebube Chineke gbazuru oku ebe nile ahu.
Enweghi abali n'eluigwe.

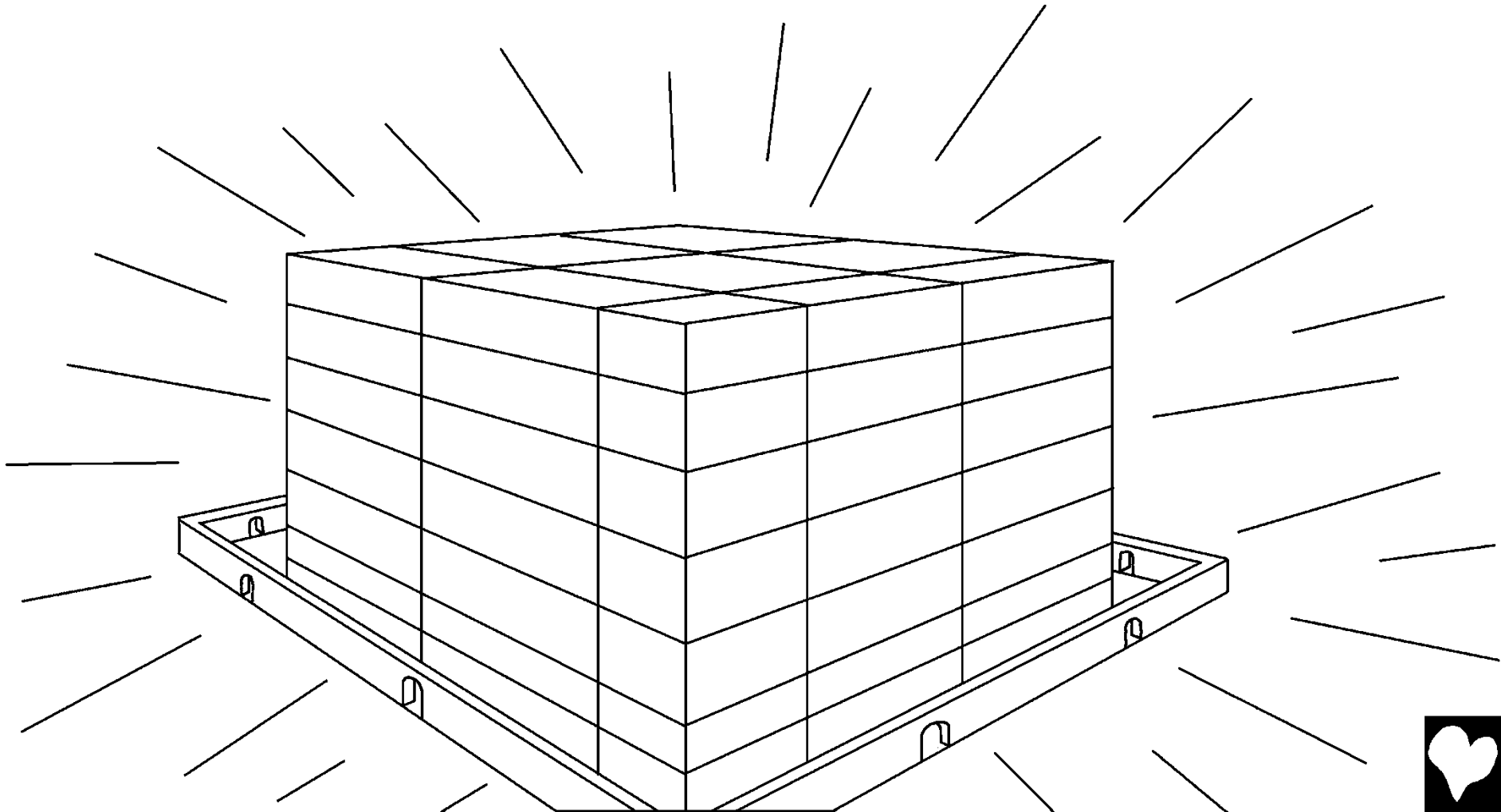

Enwe kwara umu anumanu di iche iche n'eluigwe. Ha adighi ata mmadu mana ha na aburu ndi mmadu enyi. Agu na aturu na-atakorita ahihia dika ihe oriri. Nnukwu Odum na erikwa ihe anumanu ozo n'erikwa. Chineke kwukwara si, "na ihe ndi a agaghi ata maobu meruo mmadu ahu n'elu ugwu Ya."



Dika anyi n'elehari
anya, anyi choputara na
enwere ihe ndi na adighi
n'eluigwe. Adighi
ihe dika okwu
iwe/ojoo.
Odighi onye
na alu ogu
ma obu
n'eme ihe
ga adabara
nani ya.
Odighi ihe
dika imechi uzo
na nkpochi uzo,

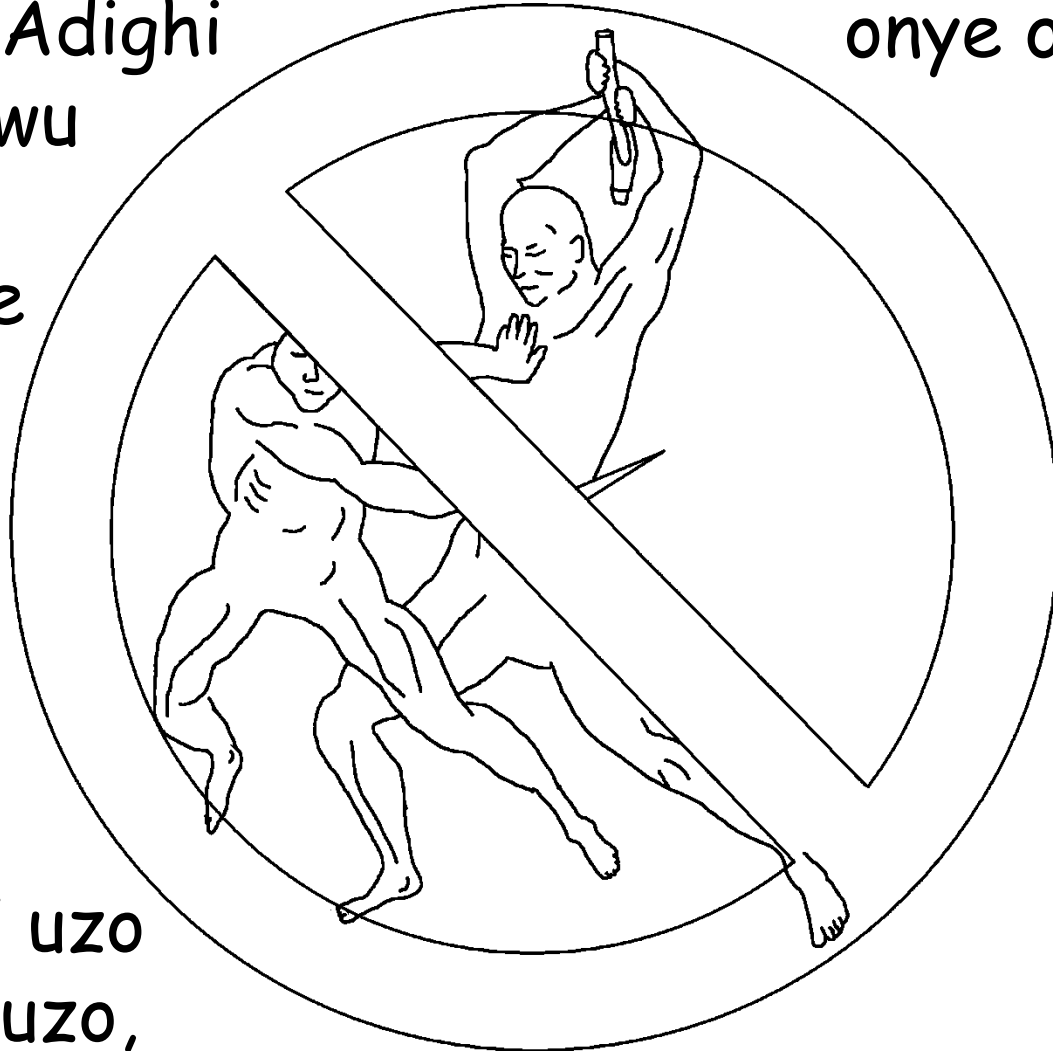

maka na odighi onye
ohi obula no n'eluigwe.
Odighi onye okwu ugha,
onye ogbu mmadu,
onye ikike
ojoo obula,
na kwa ndi
ojoo obula
n'eluigwe.
Odighi
nmehie
obula
n'eluigwe.



N'eluigwe ebe Chineke
noo odighi ihe anya mmiri
di ya. Mana mgbe ufodu
umu Chineke n'eluigwe
n'ebe akwa maka oke ihe
ojoor di n'elu uwa.
Chineke ga ehichaa
anya mmiri nile.



Onwu adighikwa n'eluigwe. Umu Chineke na Chineke
Ya onwe ga anogide mgbe nile. Odighi ihe nwute, ibe
akwa, ihe ufu. Odighi nrianna, mgbahapu ma obu
ikwa ozu n'eluigwe.

Onye obula
n'eluigwe ga
na enwe obi
anwuri mgbe
nile ha na
Chineke.



Nke kacha ihe nile, alaeze eluigwe bu maka nwoke na nwanyi na kwa ndi okenye ndi kwetere na Jisos Christi dika onye nzoputa ha ma ruwere Ya isi dika Chi ha. N'eluigwe e nwere akwukwo nke akporo akwukwo ndu nke nwa aturu Chineke.

Aha ndi mmadu juru n'ime ya.

Imara aha ndi mmadu

n'ime ya? Ndi

nile tukwasiri

Jisos obi. Aha

gi odi n'ime

akwuukwo ndu

nke nwa aturu

Chineke a?

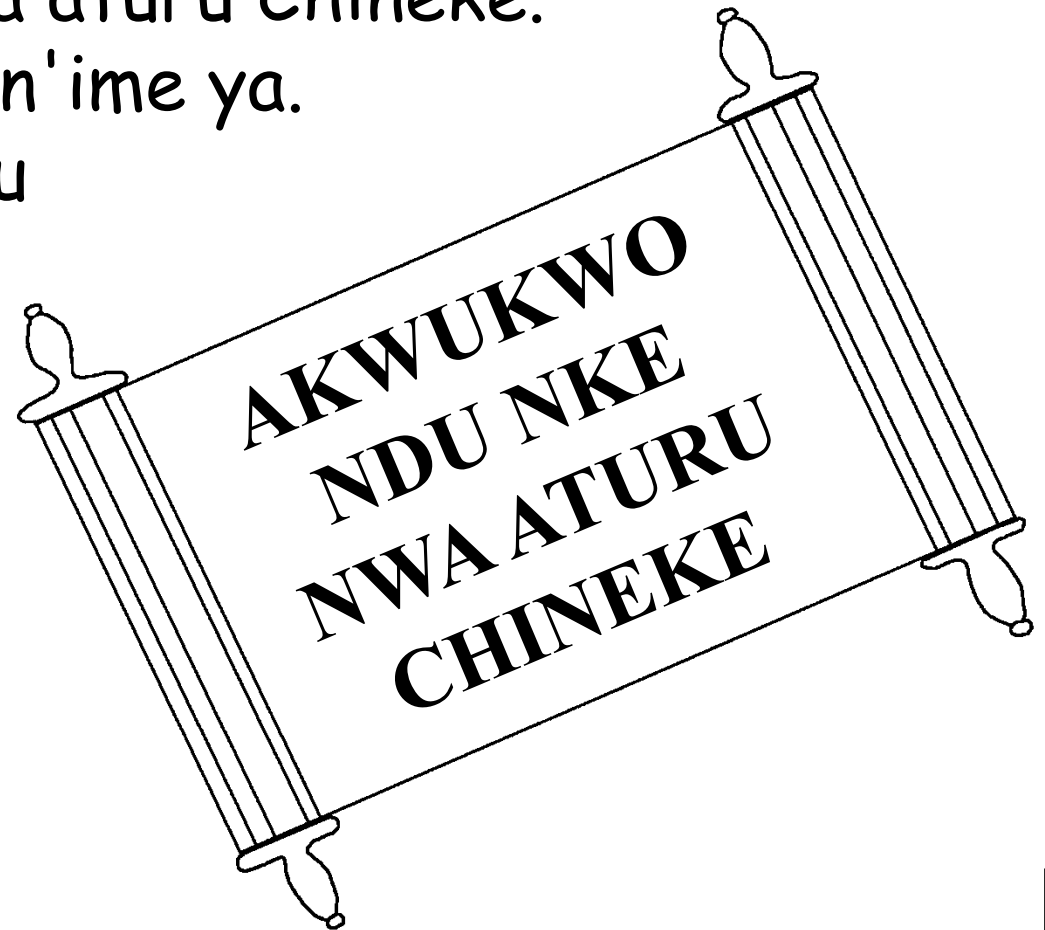

Okwu ikpeazu akwukwo nso kwuru maka alaeze eluigwe bu ezigbo na kwa nnukwu okpukpo oku.

"Mmuo nso na nwunye ga asi, 'Bia!' Onye obula nuru olu ya ga asikwa 'Bia!' Onye o bula akpiri na akponku biakwa. Onye o bula nwere mmasi ma obu onye obula

omasiri,
ya bia
nyuo



mmiri ndu a
na akwughi
ugwo o bula."



Alaeze eluigwe ebe obibi oma Chineke

Akuko nke eweputara n'okwu Chineke,
bu akwukwo nso

Di n'ime

Ozioma Jon 14;
2 akwukwo nke abuo ndi korint 5;
akwukwo mkpuhe 4, 21, 22

"Ogugu na itule okwu Chineke na-enye ihe."
Abuoma 119:130



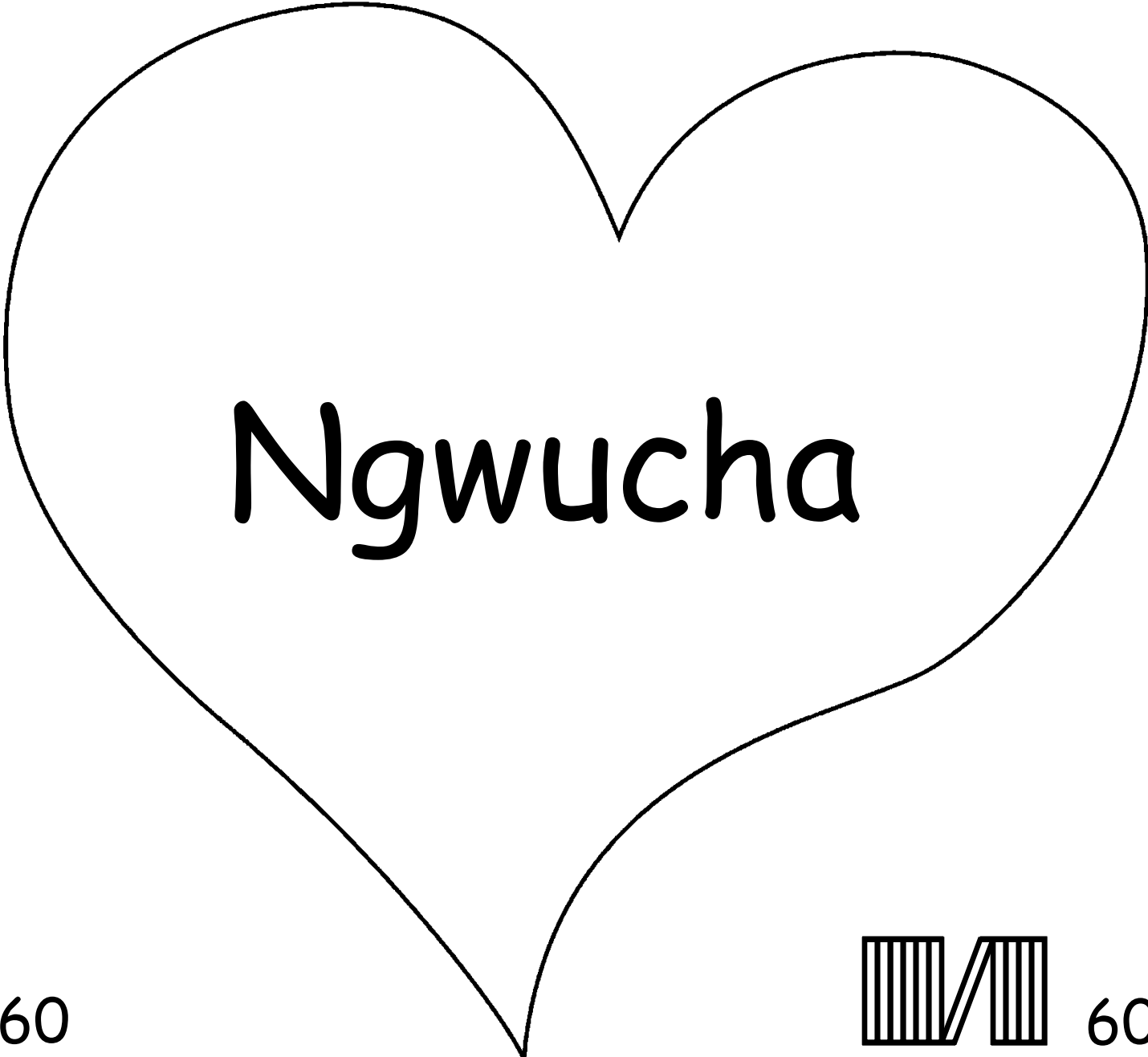

Ngwucha

60



60



Akuko akwukwo nso a na-agwa anyi maka Chineke puru ime ihe nile,
onye kere anyi ma cho kwa ka-anyi mara ya.

Chineke mara na-anyi emehie la ya, nke O kporo nmehie. Ntarama ahuhu maka nmehie bu onwu, mana Chineke huru anyi na-anya nke ukwu u O were zite nani otu nwa ya nwoke ohuru na-anya, aha ya bu Jisos ka O bia nwuchitere anyi onwu na elu obe ma nata kwa ntarama ahuhu diri anyi maka nmehie anyi. Jisos siri n'onwu bilie ma lahachi kwa eluigwe ebe O siri bia! O buru na i kwere na Jisos ma yokwa ya mgbahara nmehie gi, O ga gbahara gi! O ga bia biri n'ime gi ugbua ma gi onwe gi ga e biri kwa n'ime Ya mgbe ebi ebi.

O buru na i kwere na ihe bu eziokwu, gwa chineke ihe a: Ezigbo jisos onye nzoputa m, e kwere na I bu chukwu/chineke, i buru mmadu ka i wee nwuo maka nmehie m nile, ma ugbua I ka dikwa ndu ozo. Biko bata n'ime ma gbahara m nmehie m nile, ka m nwee ike nwe ndu ohuru ugbua, ma otu ubochi mgbe m ga abia soro gi wee biri mbe ebi ebi. Nyere m aka ka m ruwere gi isi ma bie ndu m maka gi di ka nwa gi. Amin!

Na agu akwukwo nso mgbe nile ka gi na chineke n'ekwurita okwu ubochi nile! Ozioma Jon isi nke ato amaokwu/usoro okwu nke iri na isi.

