

Bushishee Yaafeeti Koricoo

Giddiito

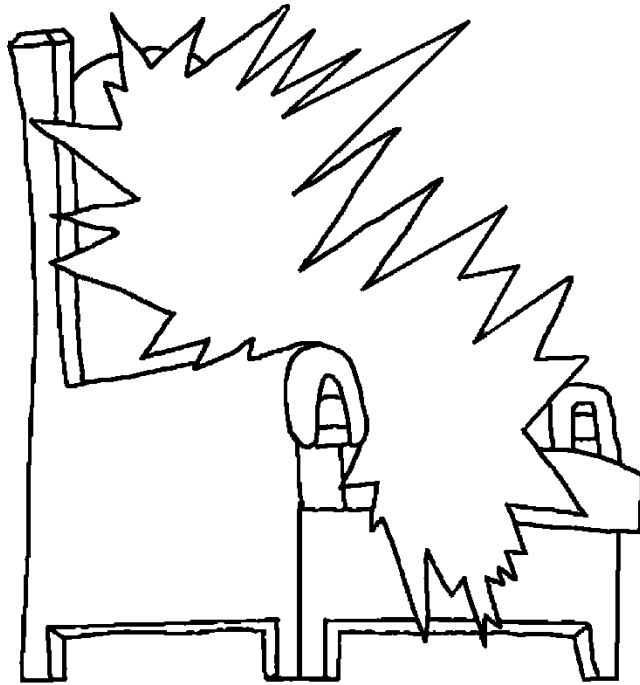

Shimaayo,
Yeerichi
gaawe
kexo



Koorito: Edward Hughes

Tachito: Lazarus
Alastair Paterson

Diciito: Sarah S.

Wochii Biichito: www.christian-translation.com

Aajjito: Bible for Children
www.M1914.org

©2021 Bible for Children, Inc.

Daaggoo: Hini shemmeeshoon woddiyee wuroo ittich beete,
tuneban kemo hakkaachit.



Yesuusi showooch bi beehooba shimaajji kexon bi dabbechina'och dojjite. "Ta nihoochi kexo" iibee ceeggiye. Aroocho wodde beemi xaa'eena'o beeteete iye. Men beemi kexina'o ogoogeena'onaa gaawetina'onane. Shimaajji kexo showeechoye gabinona oogetonane.

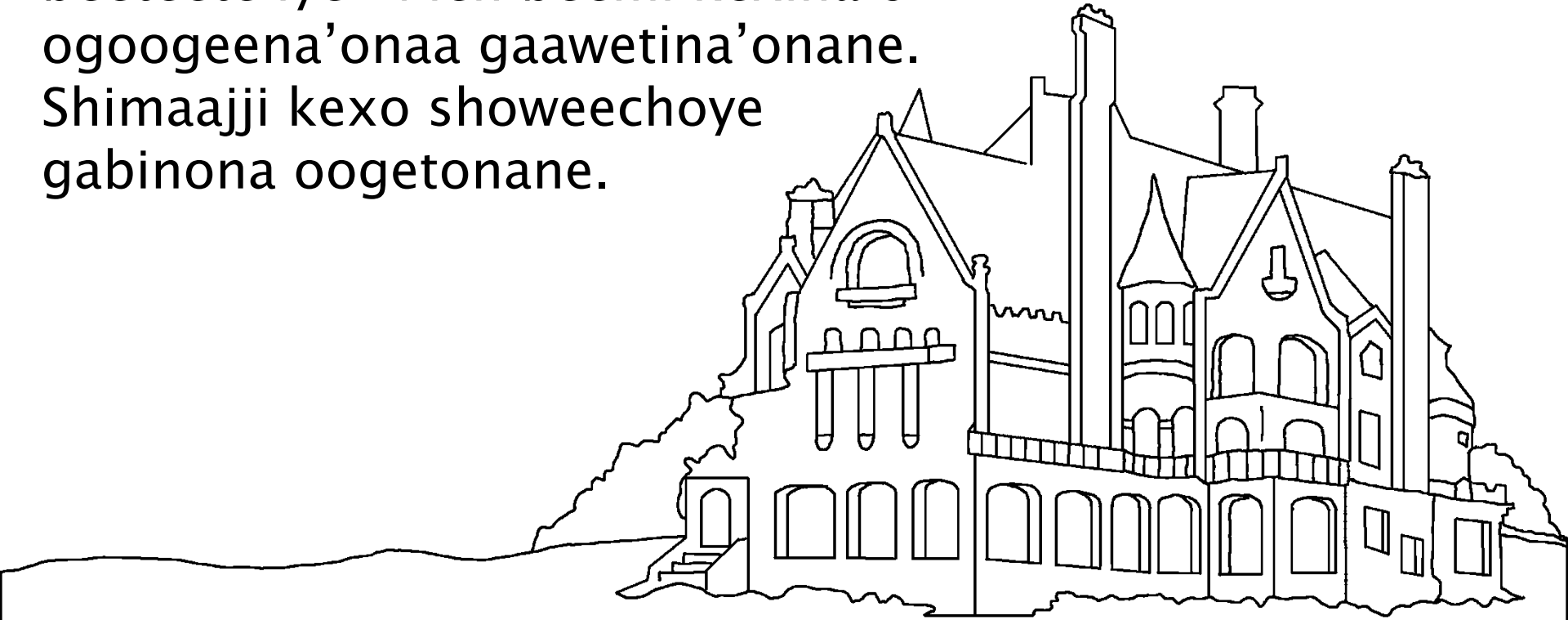

Yesuusi getti'i "Ta hammemo ittoshich kexo qannaiyane. Hamma qannaya ta immona wotte waa ittoshin daammemo taane." Yesuusi qitooche bi tiitoye gubb shimaajji kexooch hammiye. Bi dabbechina'o ciinniibeetaa hammiye. Qufoo biin daammii kaappihe.

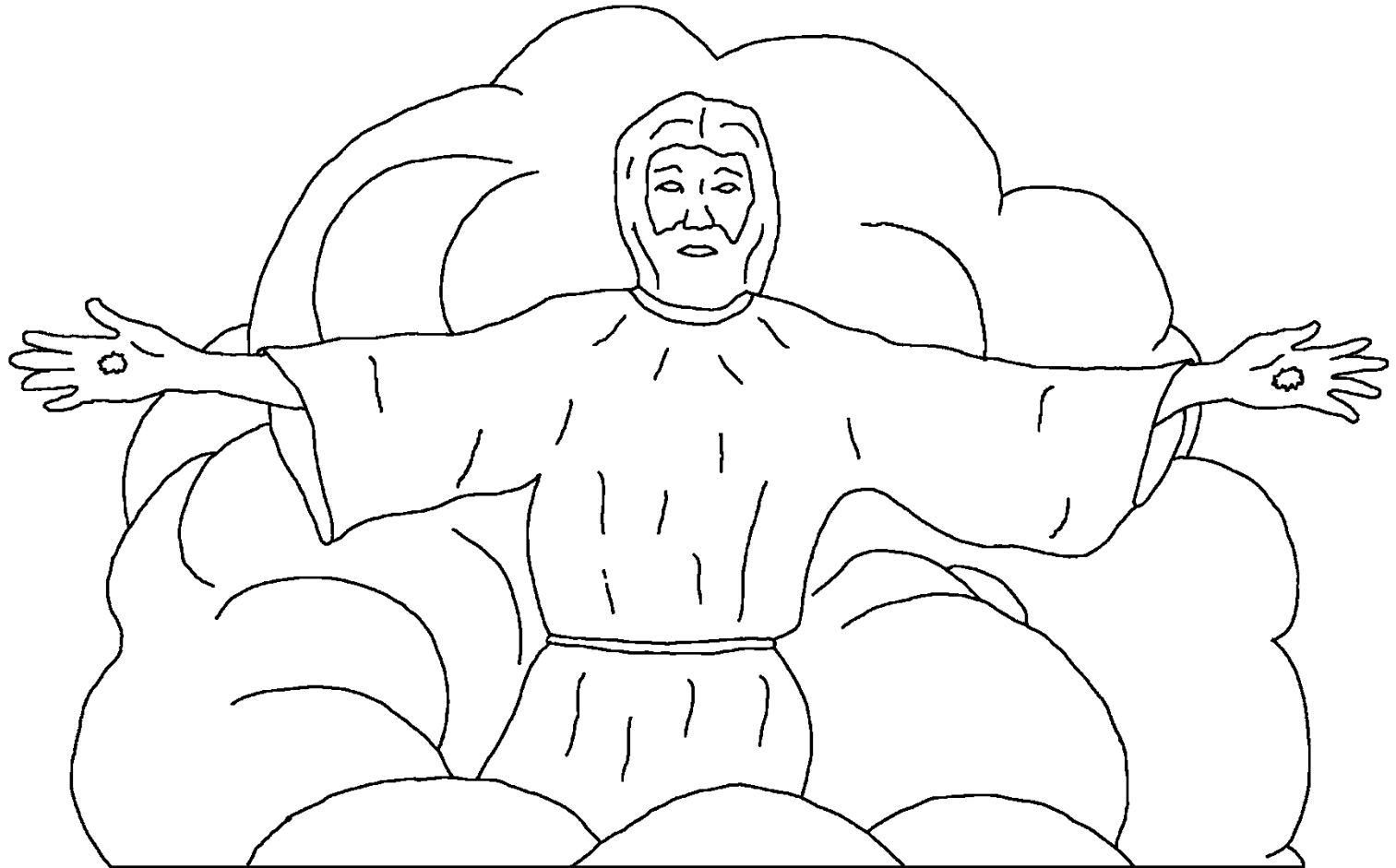

Arooye hach kittinneena'o yesuusichi wotte womi
qaaroon shalligiibeeheete. Arichiyaan goorooch bi
woyemmo tunoon yesuusi gettite. Bi womoye aaf
shiichi qitiibeet kittineena'o amo tuneheete?

Yaafeeti korico yesuusiwaan
boono hamon gettiye.
Showooche meenona
qitoo shimaayoocha
yeerina tookki
tunoone.



YEERINA
GIDDETO



Gumo, Yaafeeti koricooch ciire koricoo, shimaajji kexin gaawuchi gettiye. Ikkoona ooge mooyo shimaayo yeeri kexo bi tunoone. Yeeri aabiichona beete, tuneban bi taatittine koto shimaayochiye.

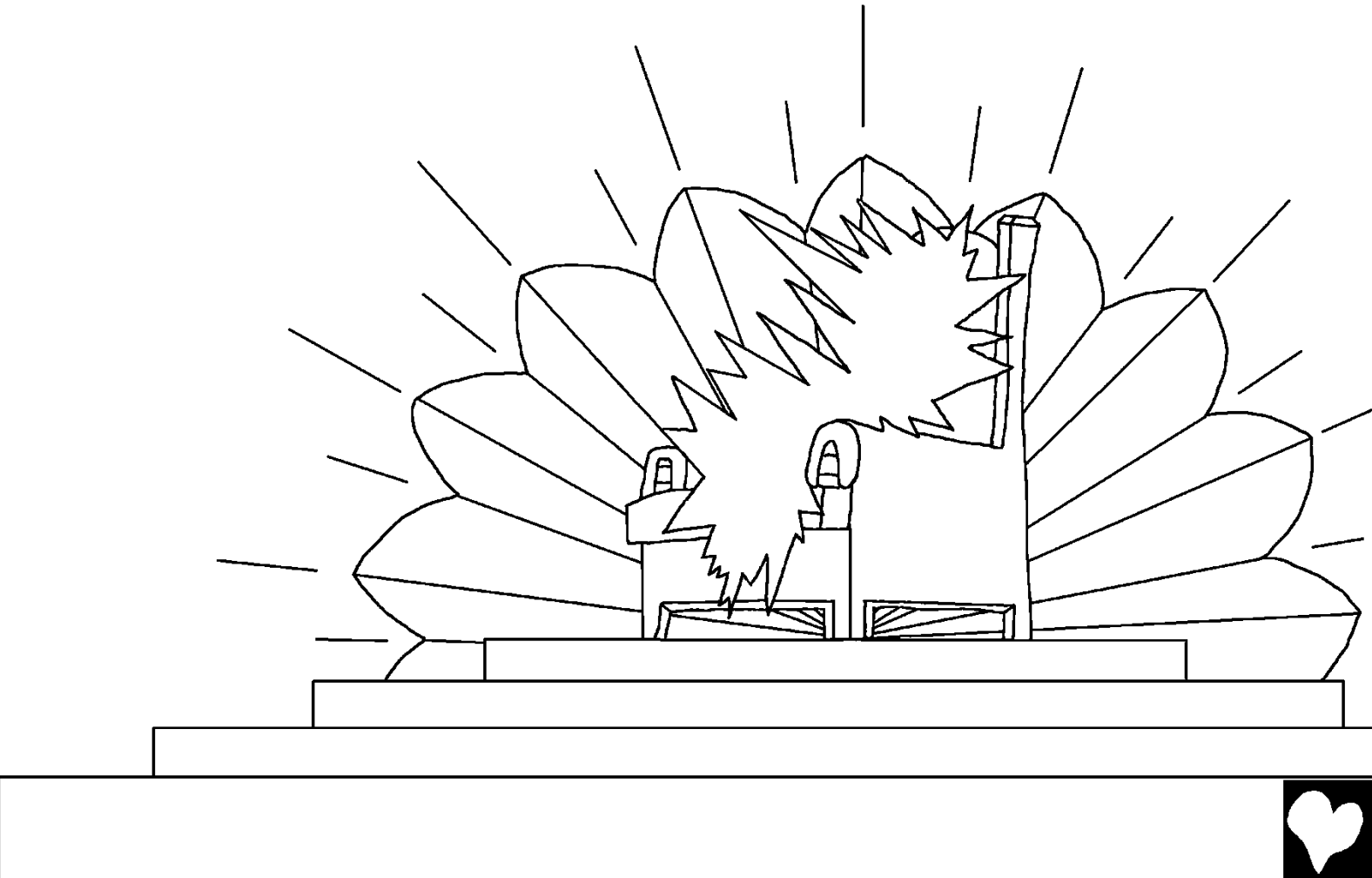

Maraakeena' onaa bare shimaajji halleena' ona yeerin
shimaayoocha oogiiheete. Ebicho meenona qitit
asheena' o shimaayooch hammiheete.

Yeerin oogiyoch tunemmi shoddoono
shoddeheete. Hin qaaro boono

shoddet shoddoche ikkoone: NOON
NE DAMOONA KICAA YEERIWAAN NE
SHAKKIYONA BARI BARE YAROOCH

WAATI NOON

YEERICH

TAATOONA

QEESHOONON

TUNIITIN.

(Yoh gumo

5:9)

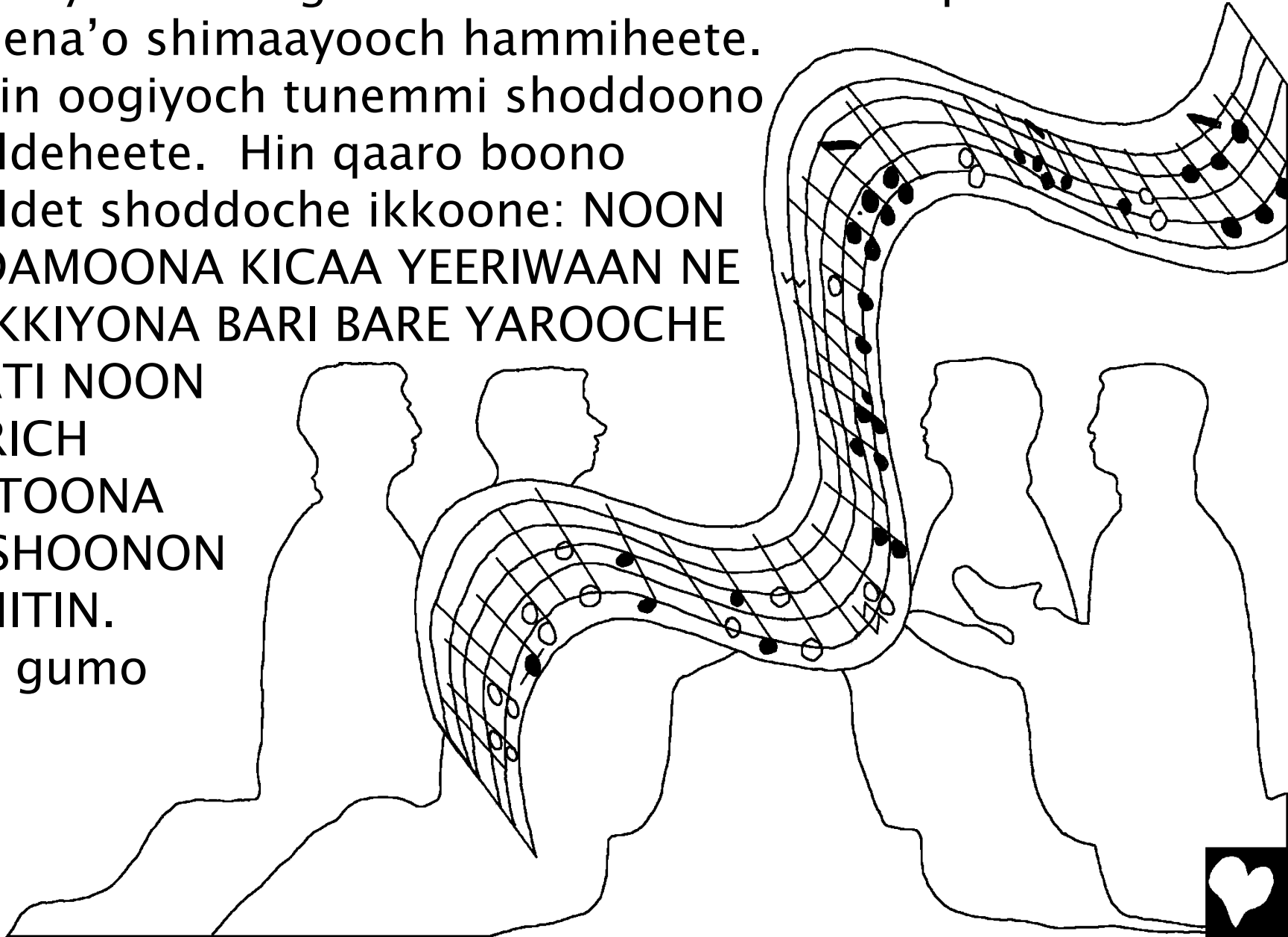

Yaafeti korice ciire qaaro shimaajji kexo “Andire Yerusaalemine” iye. Ebiyo oogetona gamini uxerechone. Uxeroo xaqqeecho. Gaawe geexeena’ona xaqqeena’o phaqqiibe uxeree timooch koteteete. Bulle katemee gimeena’o ogoogoonna shuuneetina’one!

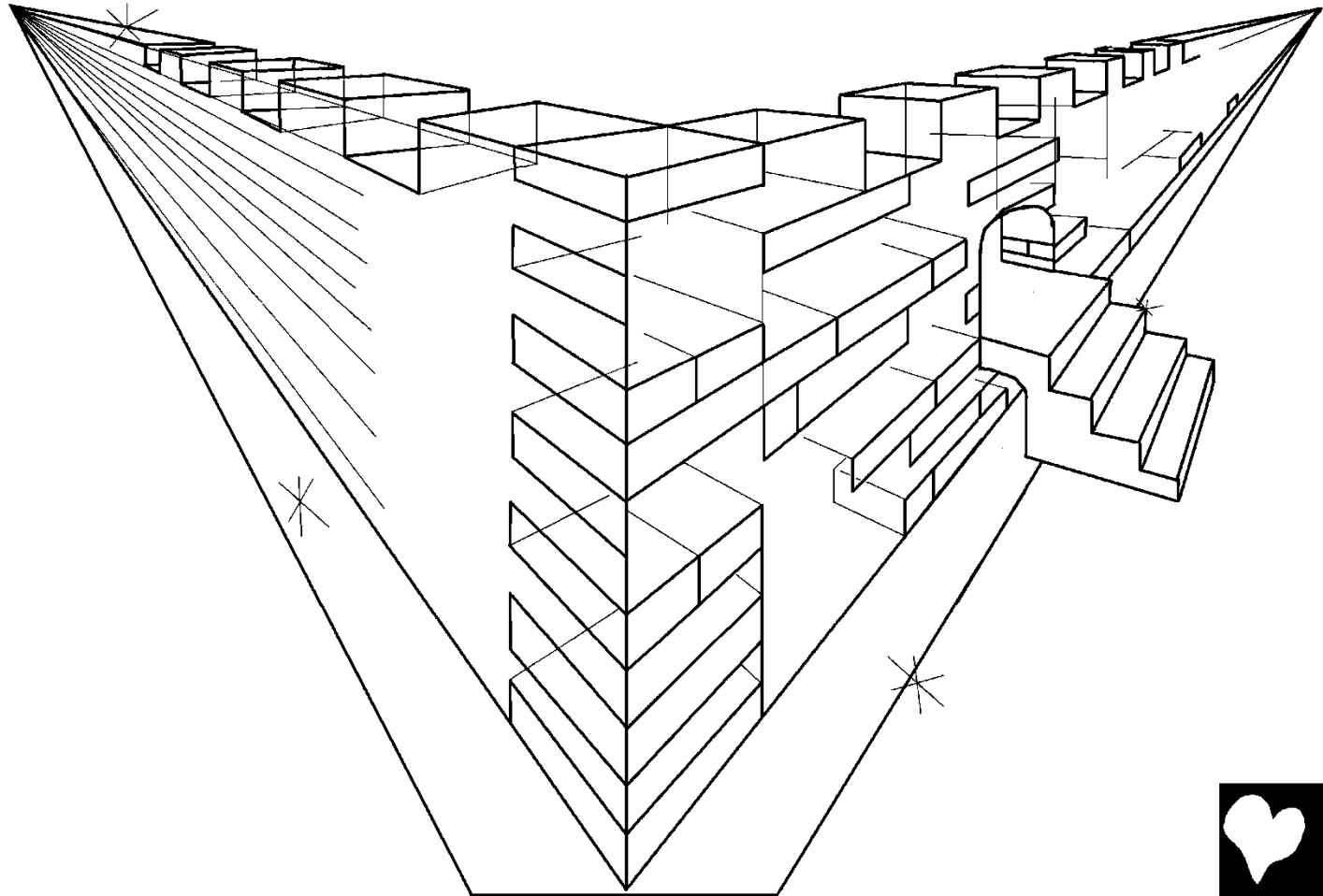

Men ogooge gaawe kelleena'o hichiyaacheete. Eka maac
gii ciinon...waw! Shimaajji kexo maaca oogii gaawetone.
Kateme shuuneeto xure worqoocheniye. Gommo
beddaaha shuuneto worqoonane.

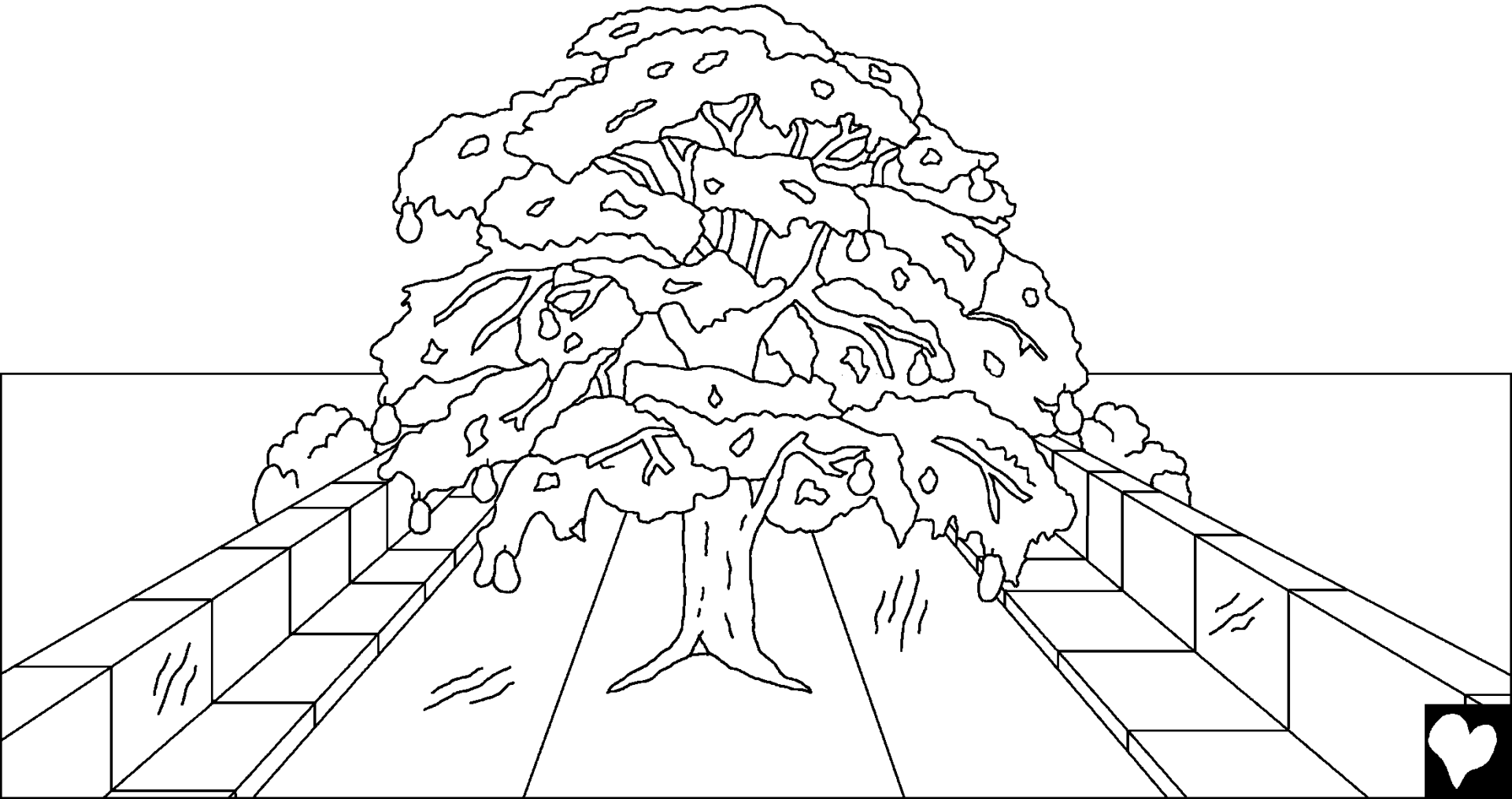

phixxaashoona gare aaco yeerich taatittinooche
xuuphihe. Aacoye okk batti batt eden danet kashe mixo
beete. Ebi mixo oogii baritone. Agen agenoona barbaroo
tunet Araa gutte shaahech aafoon aafehe. Michi waamo
shijjerooch atto tunehe.

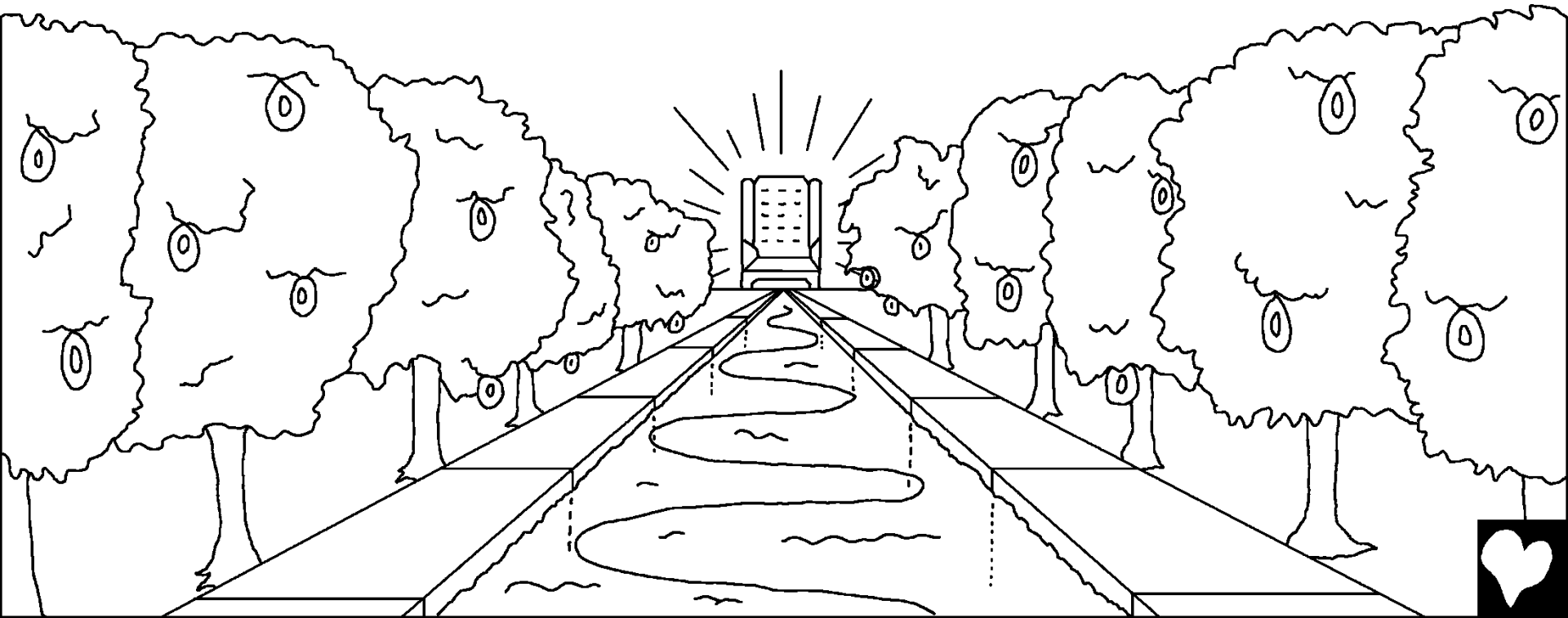

Shimaajji kexo abeenno tuneba ageneen bekkooch qaawaache. Yeerichi oogittino ooget bekkoonna ceechiye. Arooch xumo aalloone.

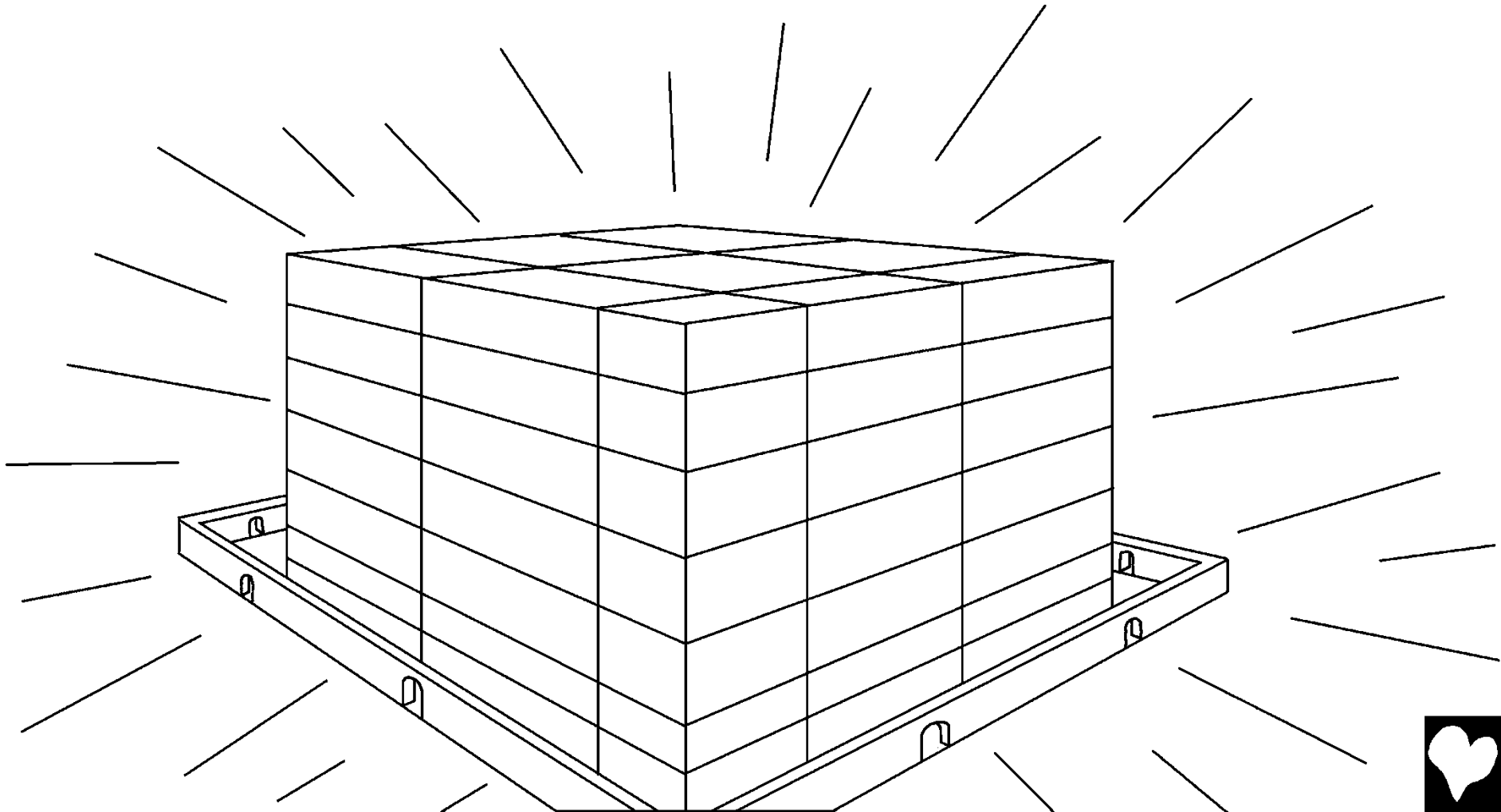

Shimaajji kexooch beeti cooxina' o baribareena' one.
Ubba de' eena' onaa nuucheena' onane. Okeroona
bagoona tookki ikkooch maaheete. Daaheroo
gattoochoomon maahe. Yeriyo ishichiye "Taachi
yaafeet geppoon duubiyaacheete."



Okk hach no ciinigaa,
shimaaji kexooch ikke
shappit mooyon
ciinnehon. Ikke gonde
qaarona gettiyaache.
Koniyona kaariyaache,
taach baach getaache.
Kellooch qulfo aalle,
ame gaayona arooch
aalli goodooch.
Kooto yibbaatecho,
uppiibeeto,
wuxiibeeto tuneba
gonde moochecho
aron aalloone.
Ame axaaxoona
arooch aalle.



shimaajji kexooch
yeerina tookki ame
acimona aalle. Ikkike
kaalloon, yeerichi
asheena ogeeti
iritiyoona eepiheete.



Shimaajji kexooch qitoo aalle. Yeerich asheena'o ubbe
aaboon biinna tookki'iniye boono beeto.



Bulliye damba shimaajji kexo bushisheena'och gaawetone (aroocheno dicciheete) yesuusin boono wodiyecho tunii yechiheete. Shimaajji kexooch bagoochi kasha koricoo getteebeeto beete. Arooch ubbe ashi shigo beete. Koni koni shigo gaata arooch kooreeto ariin? Yesuus toommooch boono gibenoon duppitina'o ubbi shigoone.

Ne shigo
arooch beet?

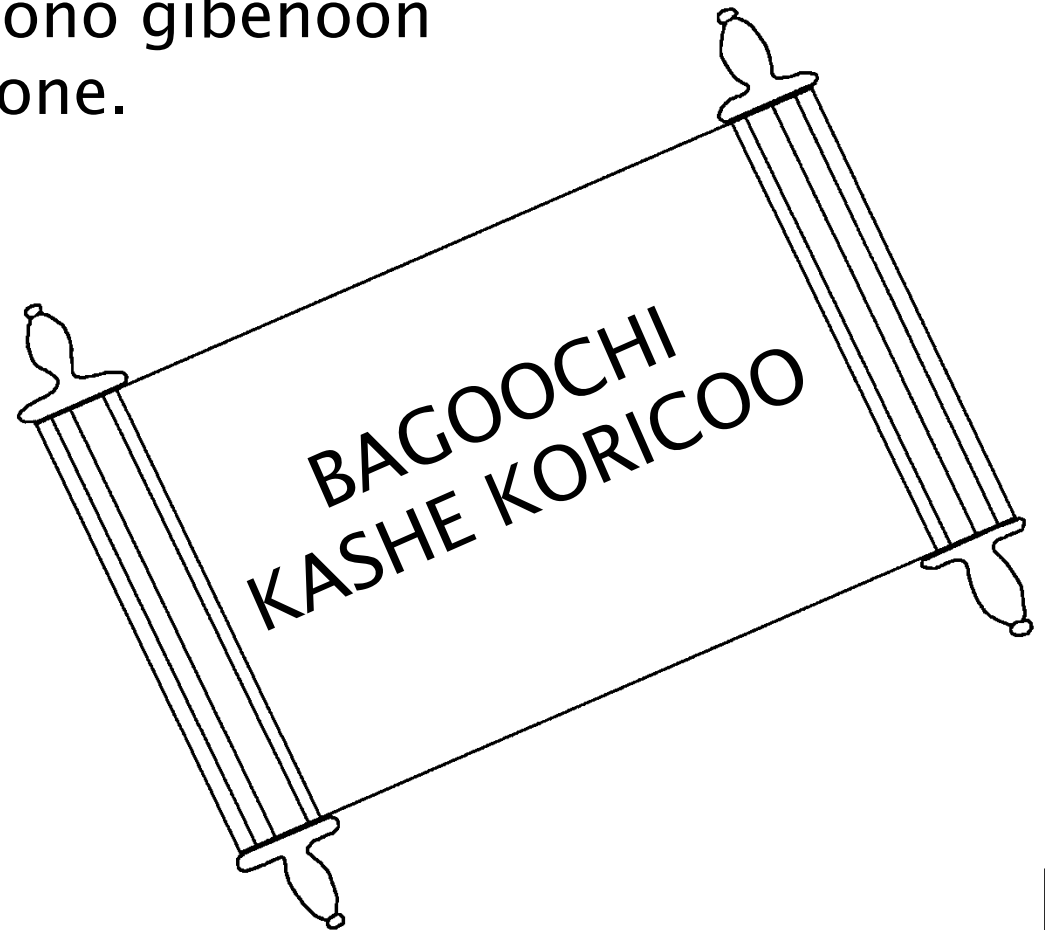

Shimaajji kechi Yaafeeti koricee ciire qaaro oogeti
ataalechone. “Yaafe ayaanoona gaarechona iichiyeete,
‘wob!’ ebin waayeebeeto bulliyo ‘wob!’ geta.
Shacheweto bulliyona woba. Qaawito bulla
woba, kashe aacon daamba.”

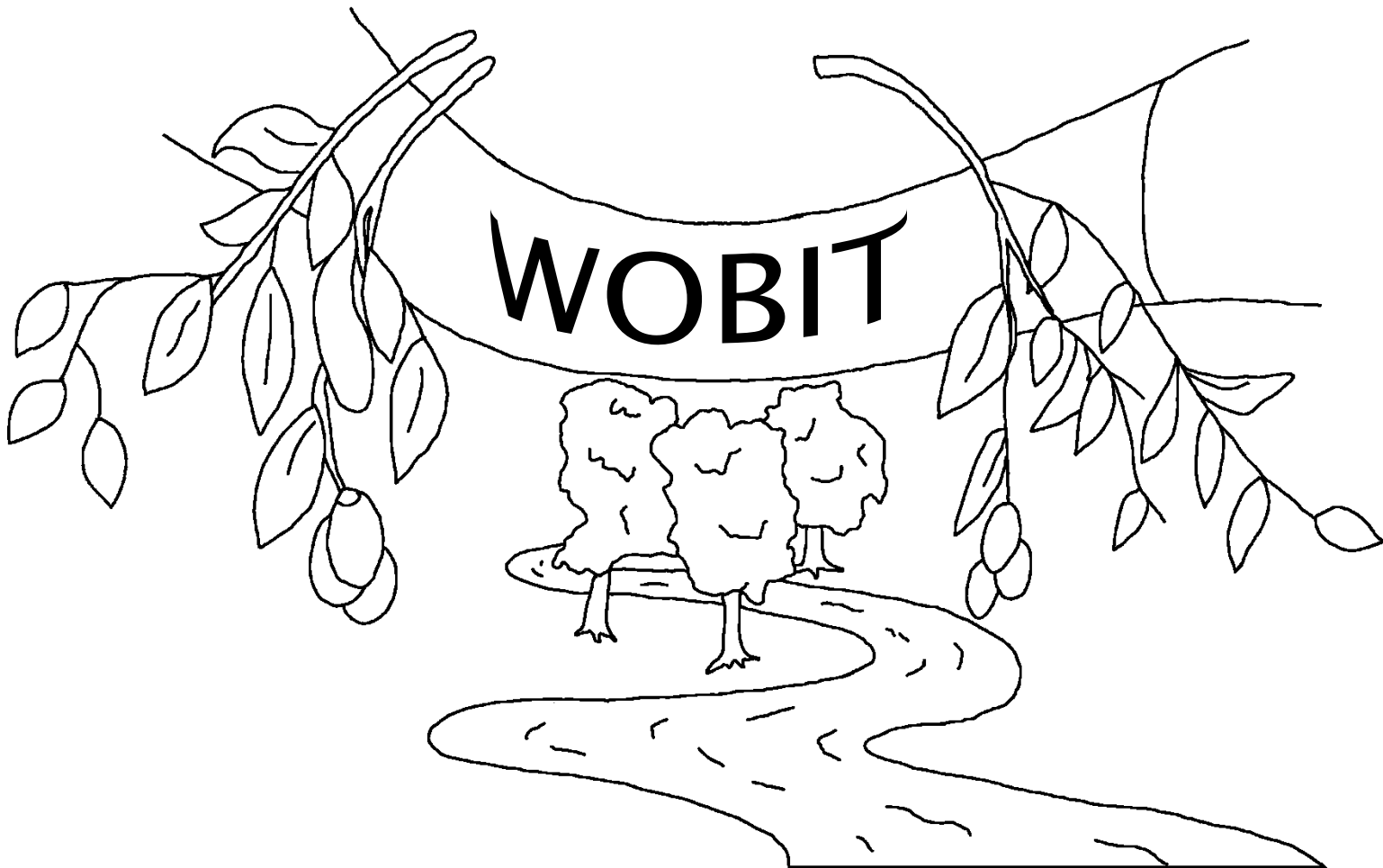

Shimaayo, Yeerichi gaawe kexo

Shemmeeshoo Yeer qaaro tuneti Yaafeeti
koricooche,

Dane xaa'oo

Yohannis Wongeelo 14; 2 qorontos 5;
Yohannis Gumo 4,21,22

“Ne qaare gimo bekkoon immihe.”
Shoddo 119:130



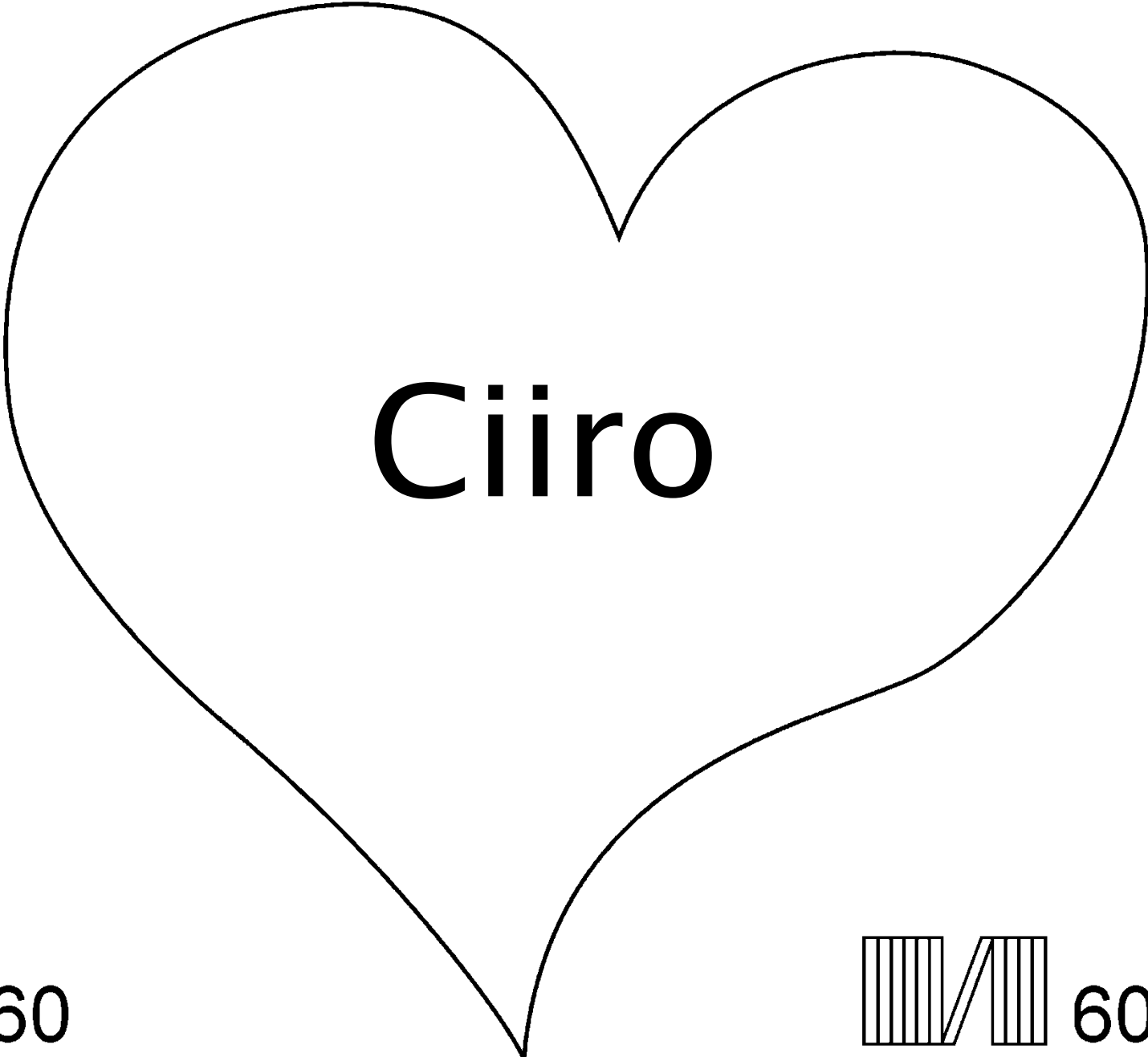

Ciiro

| 60

||||| 60



Hini Yaafeeti Koricee shemmeeshoo nooch bi gettiibeeto oogeti no doono Yeeri noon hallitona biin no ariyemmoch tuniitoniye.

No doono Yeeri axaaxoo getteeti gonde mooyon no shuunoon ariihe. Axaaxeechi naxoo qitoone, tunebani Yeeri noon oogii bi shunnitoch ikke mixxe bi bushoo Yesuusini mashqaree toommooch kake bi qitiyemmona no axaaxe meeshoon bi qoccemmoch deejjihe. Yesuusiyo showooch bi waatooye gubb wotte shimaajji kexooch hammihe! Yesuusina gibenacha itti axaaxoon bi qajjemoch itti echegaata aro ittin maarihe. And ittin tookkii beehe, ittiyo biinna tookka bullaabich beehit.

Ebi iberoo bi tunoon itti gibenegaata, ebin yeerich getit: Shucheti yesuuso, Ne ta axaaxoch qititi yeeri ne tunoon gibenoye, ando taanna tookka beetine. Doogena ta kasheech waa ta gondoona maaribe, arooye gubbo andire kashoona beehoye. Ikke qanoona neenna tookki bullaabich hammemotaane. Ne bushoon tunoona neech beemo ta hakkiyemoch doogena taan gaachebe. Amen!

Ubbe aaboon Yaafeeti Koricoon shemmoona Yeerina yibbaatebit!
Yohannis Wongeelo 3:16

