

Mbivilia ya syana
Yîmûetee



Ituni musyi
mwanake wa
Ngai



Yîandîkîtwè ni: Edward Hughes
Yonanítwè kwa: Lazarus; Alastair P.
Yumîte kwa: Sarah S.
îalûûlitwe ni: Prudence Ndunge
Yumîthîtw'e ni: Balm Africa Concern
www.M1914.org

BFC
PO Box 3
Winnipeg, MB R3C 2G1
Canada

©2021 Bible for Children, Inc.
Lisenzi: Wina mwanja wa kumîsya kana kumîthya eethîwa
ndûkumîthya nîkana uthoosye.



Yila Yesu wekalaa kuu nthi niwatavisye atume make
iulu wa ituni. Eita itu "Musyi wa asa wakwa," na wina
mawikalo maingi muno. Mawikalo
ni musyi munene mwanake.
Itu ni inene na niyanake
muno na kuyaoneka
musyi mwanake
tusu kuu nthi.

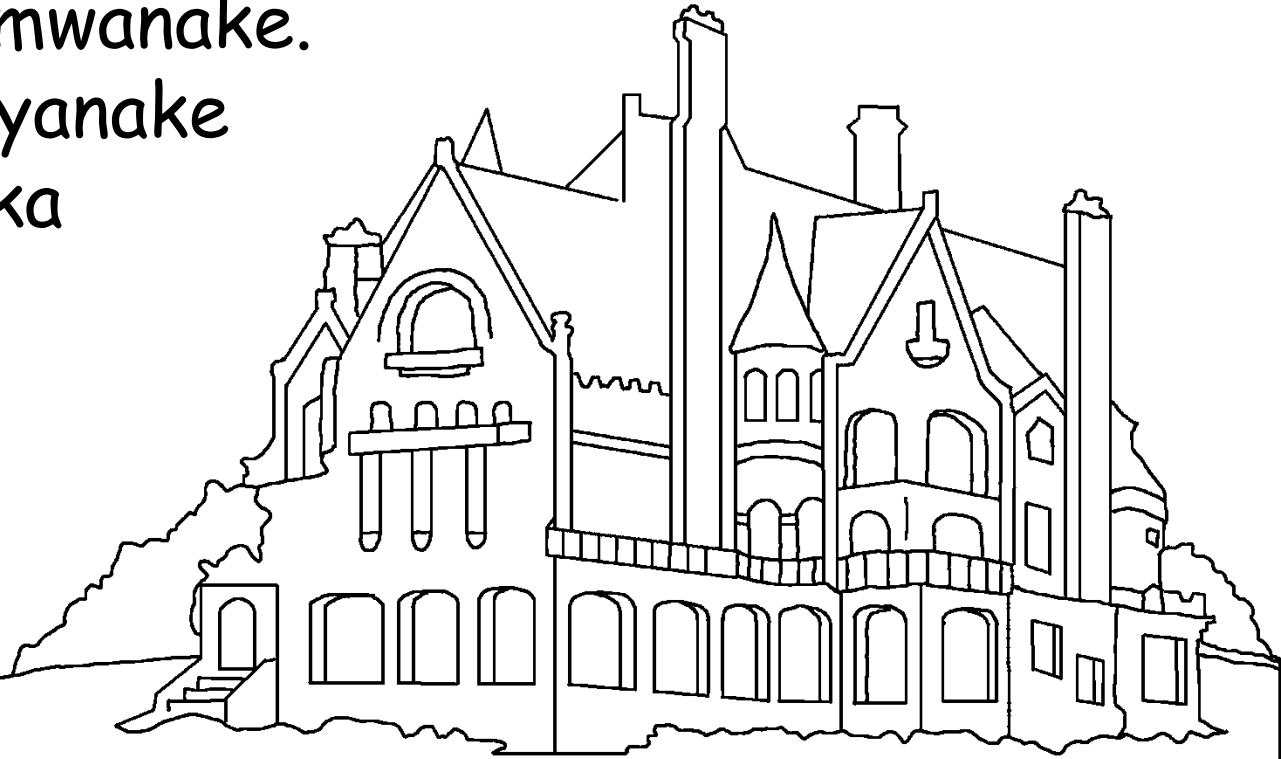

Yesu asyaa, "ninanthi kumuseuvisya vandu na namina kumuseuvisya ngoka ingi nimwisie." Yesu niwambatie ituni yila wathayukie kuma kwa akwu. Atume make masyaisye, Yesu niwoosiwe ambatwa iulu ituni na matuni nimamwosie na maeka umwona.

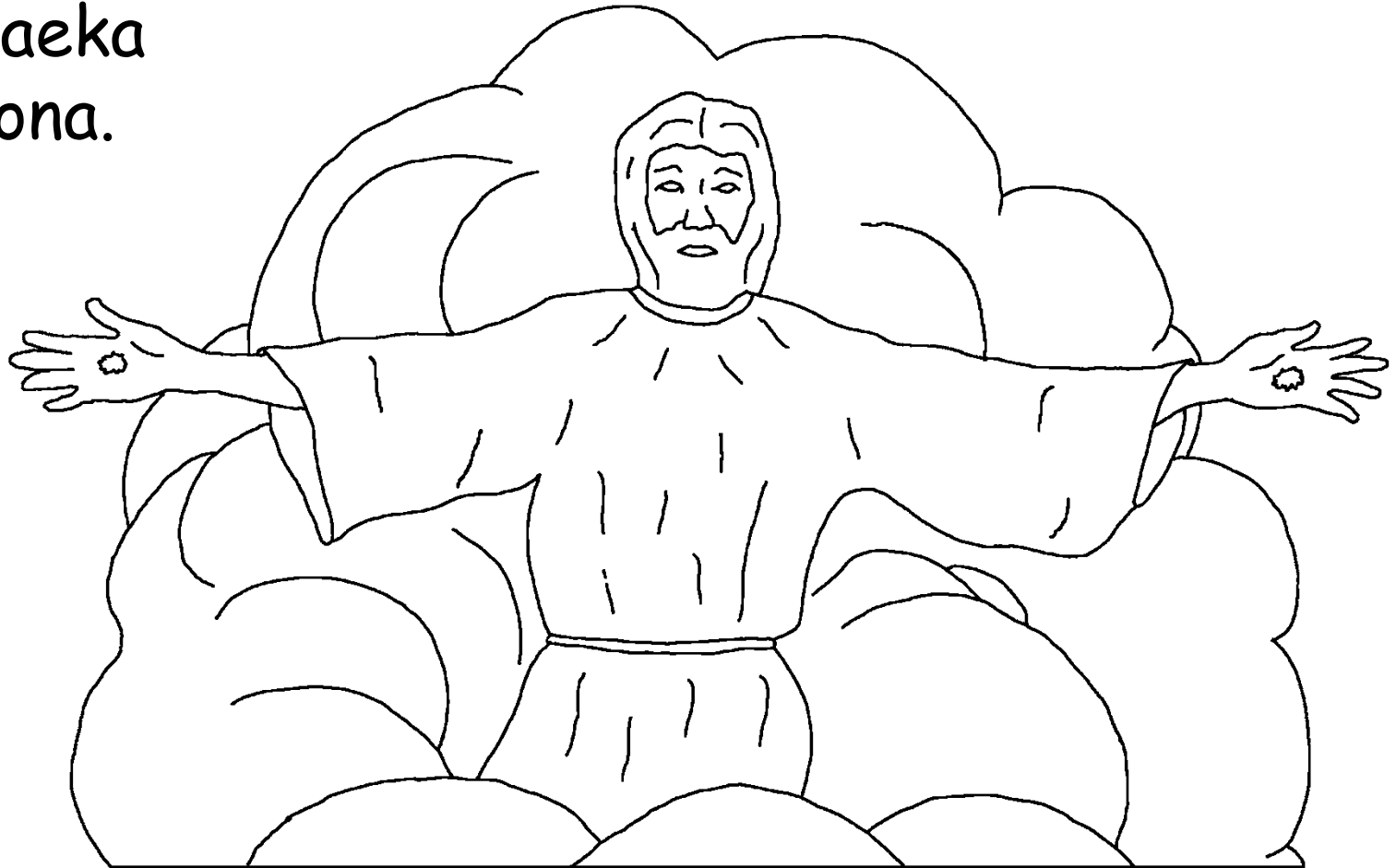

Kuma ivinda yiu, akilisto nimalilikana Yesu.

Ameei kana akooka ingi kumesia. Aisye kana akooka ta kingie. Lakini kukethya kuilyi ata kwa ala makusaa atokiti? Mbivilia nitutavitye kana maendaa imwe imwe kwithiwa na Ngai. Kwithiwa mwii utevo ni kwithiwa wivo vala ve Mwiai.



Kwithiwa na
Mwiai



Uvuanwo, ivuku ya mviso ya mbivilia, yitutavasya undi itu yanakavite. Kwa kitumi ki mwanya itu niyo musyi wa Ngai. Ngai ekila vandu na usumbi wake wi ituni.

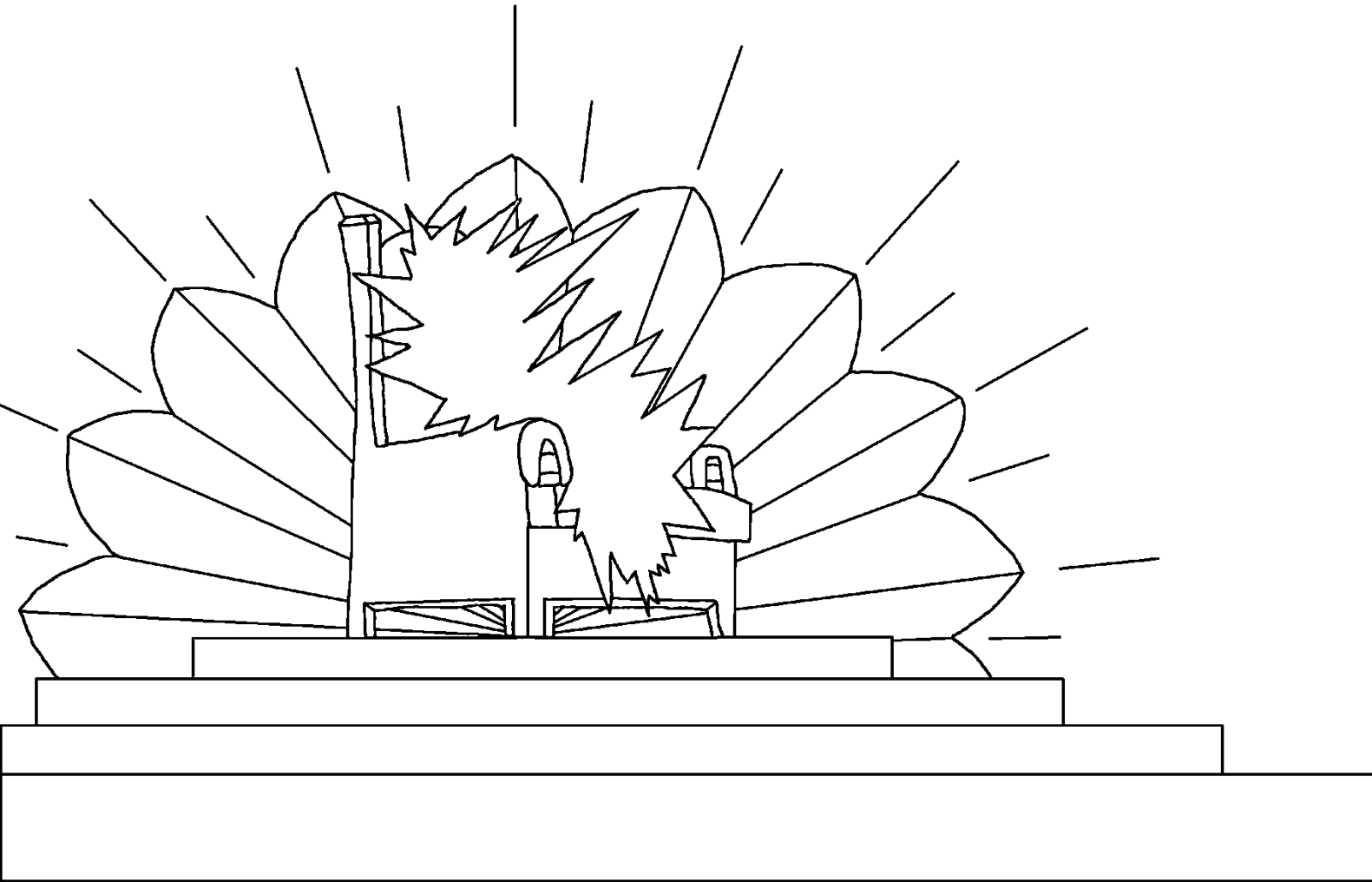

Alaika na syumbe ila
ingi syi ituni nimukumasya na
kumuthaitha Ngai. Kwa kwika
ouu, andu onthe ma Ngai ala
makwie na mathi ituni maina
mbathi nzeo sya
kumatia
Ngai.

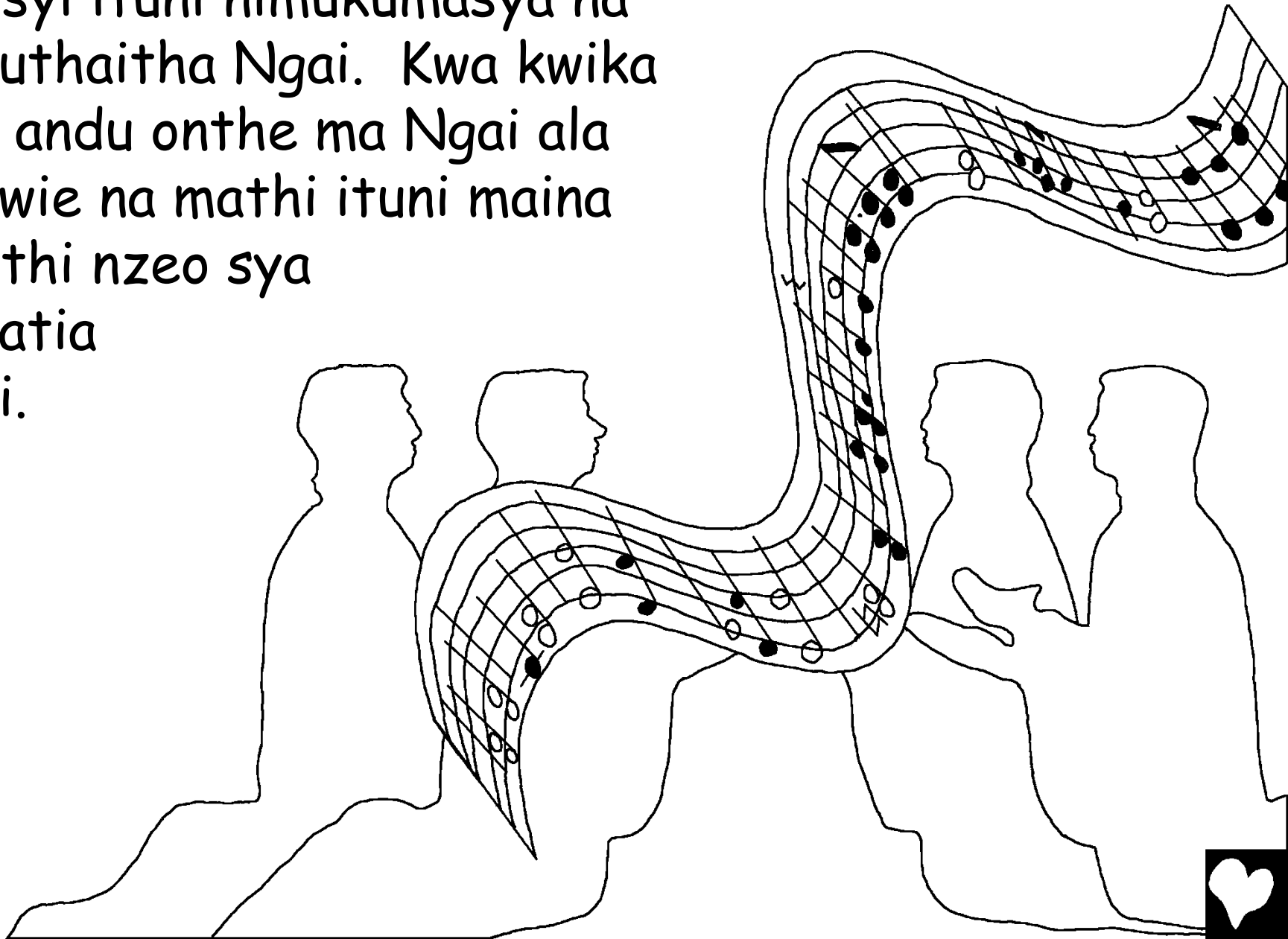

Vaa ve ndeto sya wathi umwe mainie:
We wiwa lato nene nundu niwatwovoisyey
kula kwi Ngai na thakame yaku
kuma kila mbai na nthi syonthe
na niwatutwikithisyey asumbi
na athembi kula kwi
Ngai waitu.
(UVuanwo
5:9).

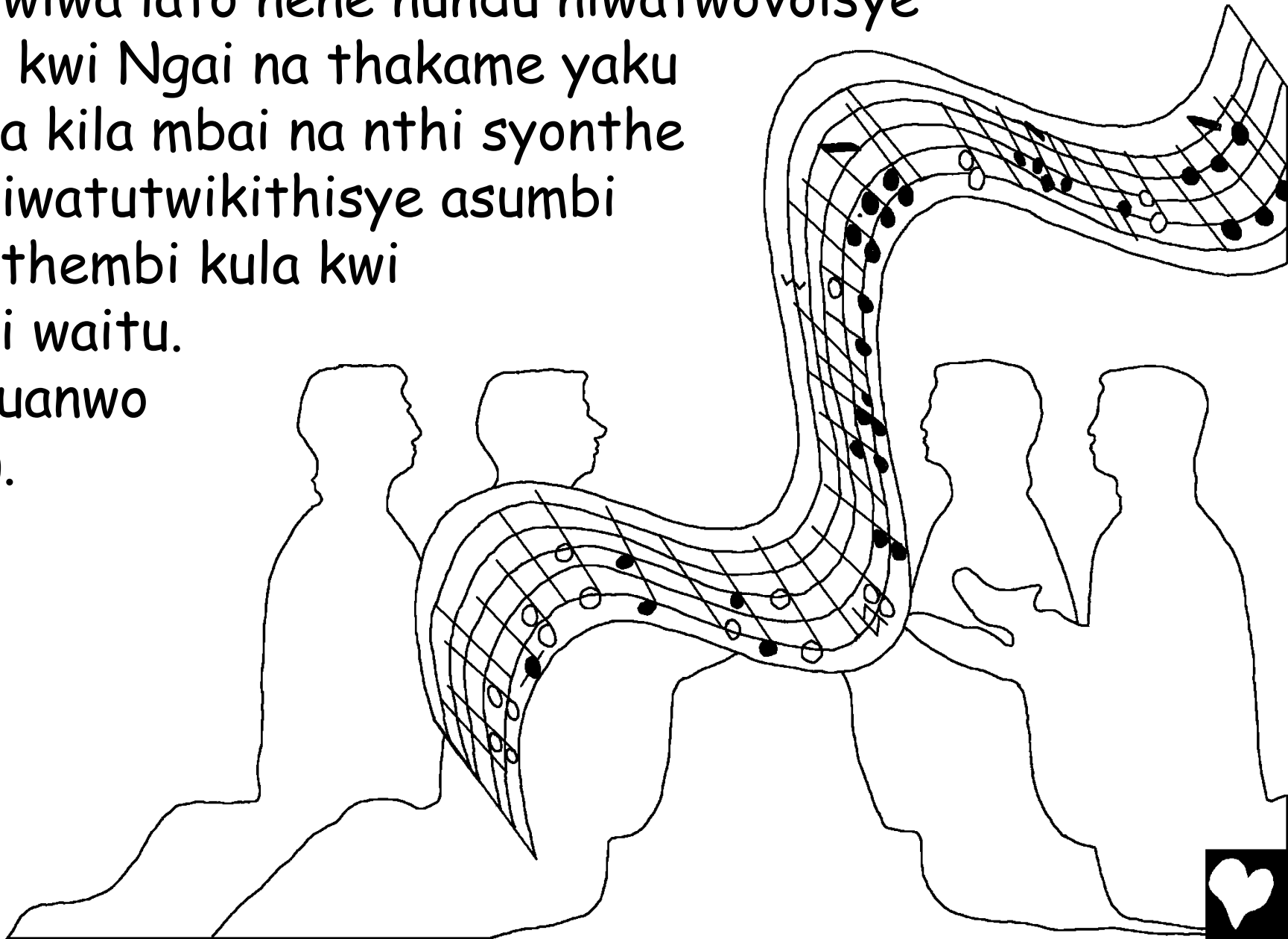

Ithangu ya muthya ya mbivilia yielietye itu ta,
"Yelusalemu nzau". Ni inene, inene muno yina ukuta
mutulu nza, ukuta wakwitwe na mavia malumu
meukengakenga ta ngenyingenyi sya uakangani.
Masoa na mavia matheu meutisatisa mavyikite

musingi wa ukuta,

wina
malangi
makundu
na kila
muvea wa
musyi
useuvitwe
na miomo
minene ya thaavu.

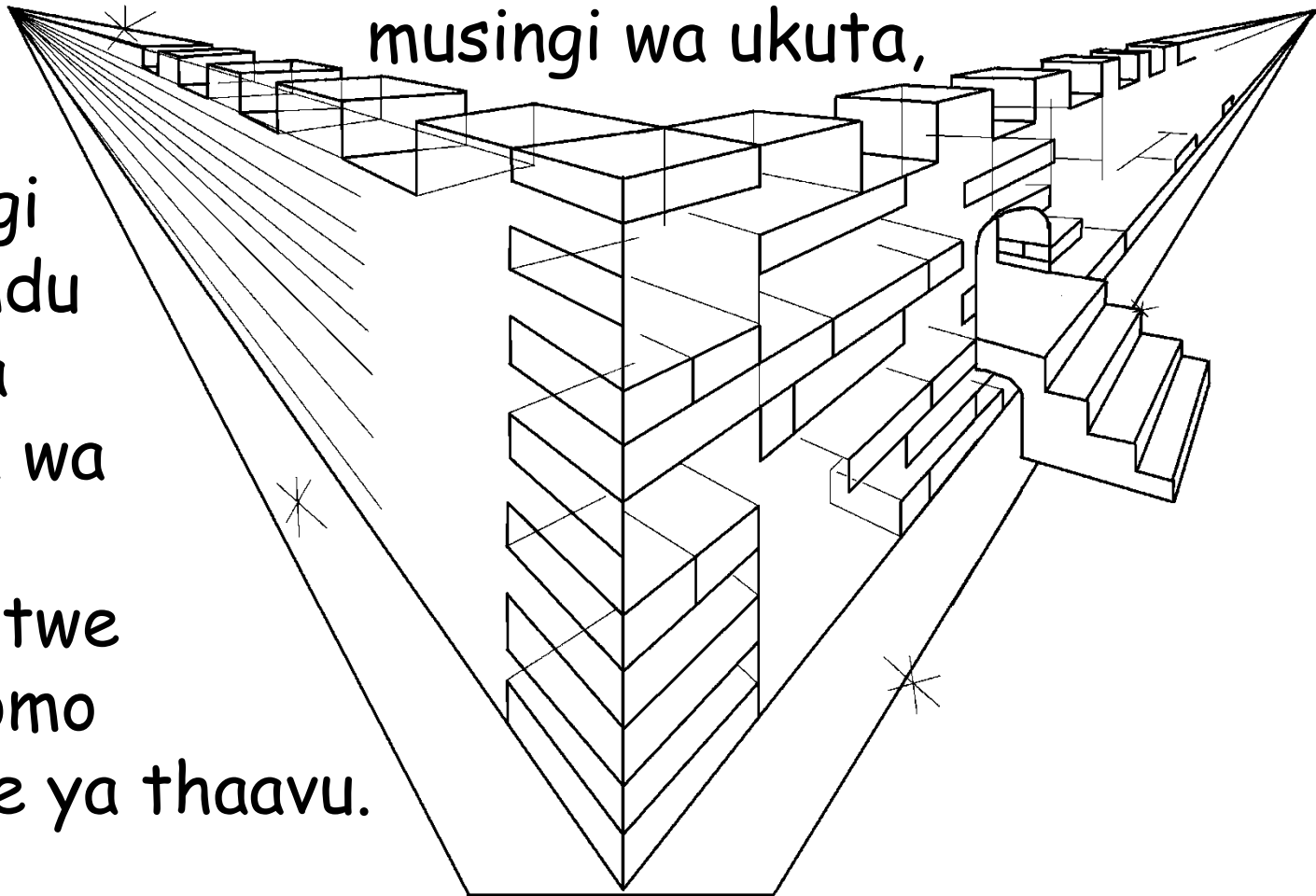

Miomo isu minene ya thaavu ndi vingawa. Tuthi nthini tukeeloele. Mwanye!! Itu kau niyanake muno ou nthini!!!! Musyi usu wakitwe na thaavu muthei, ta kioo kitheu, ona nzia syakitwe na tahhavu.

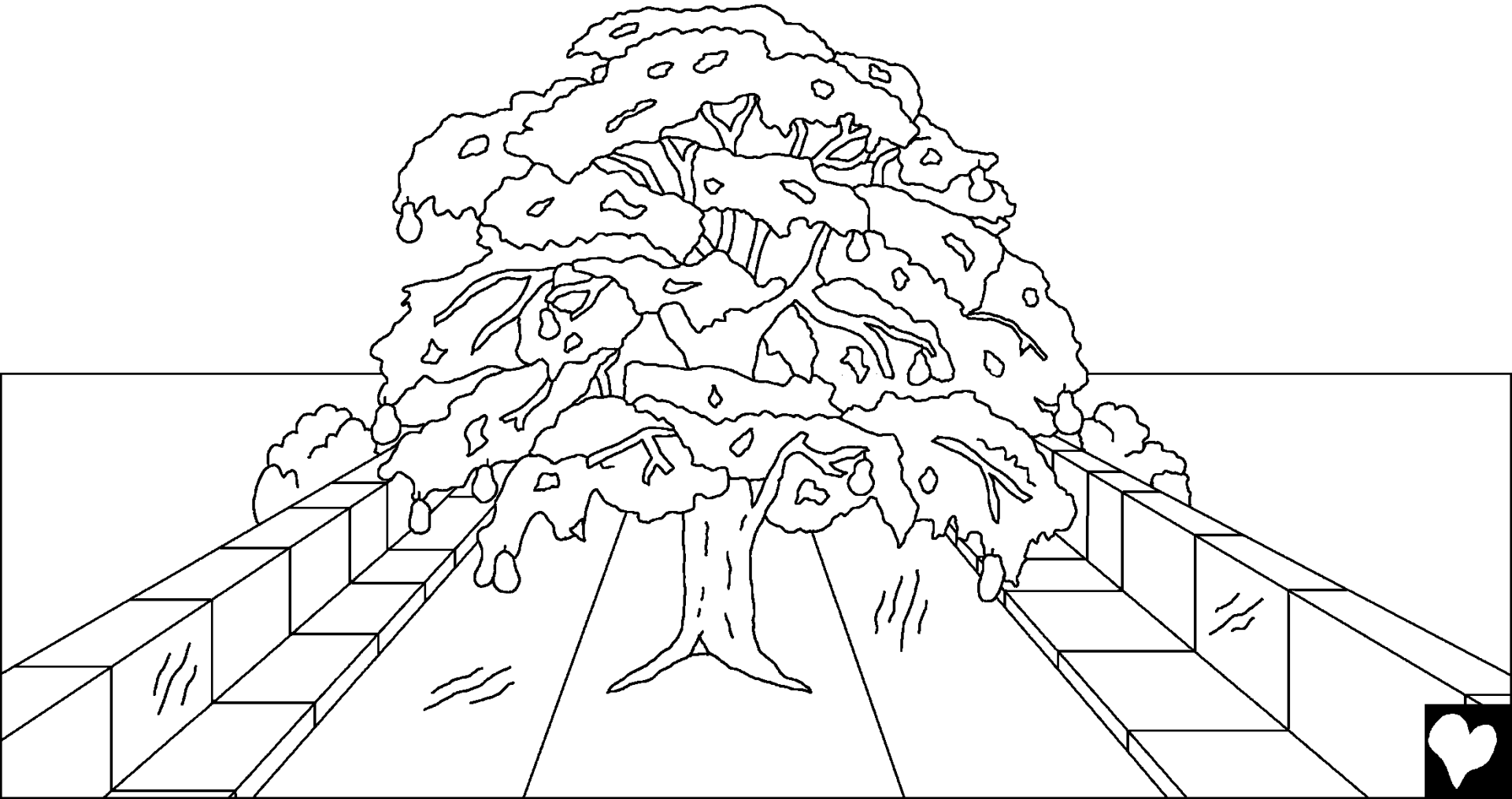

Mbusi ntheu sya kiwu kya thayu kyumite kivilani kya Ngai. Na kila ngaliko ya usi veethwaa kiti kya thayu, kila mbee kyoonianite mundane wa eden. Uu ni muti wa mwanya. Usyaa mithemba ikumi na ili ya matunda, kivathukanwo kila mwei. Na matu ma muti usu wa thayu nimatumikaa kuvosya nthi syonthe.

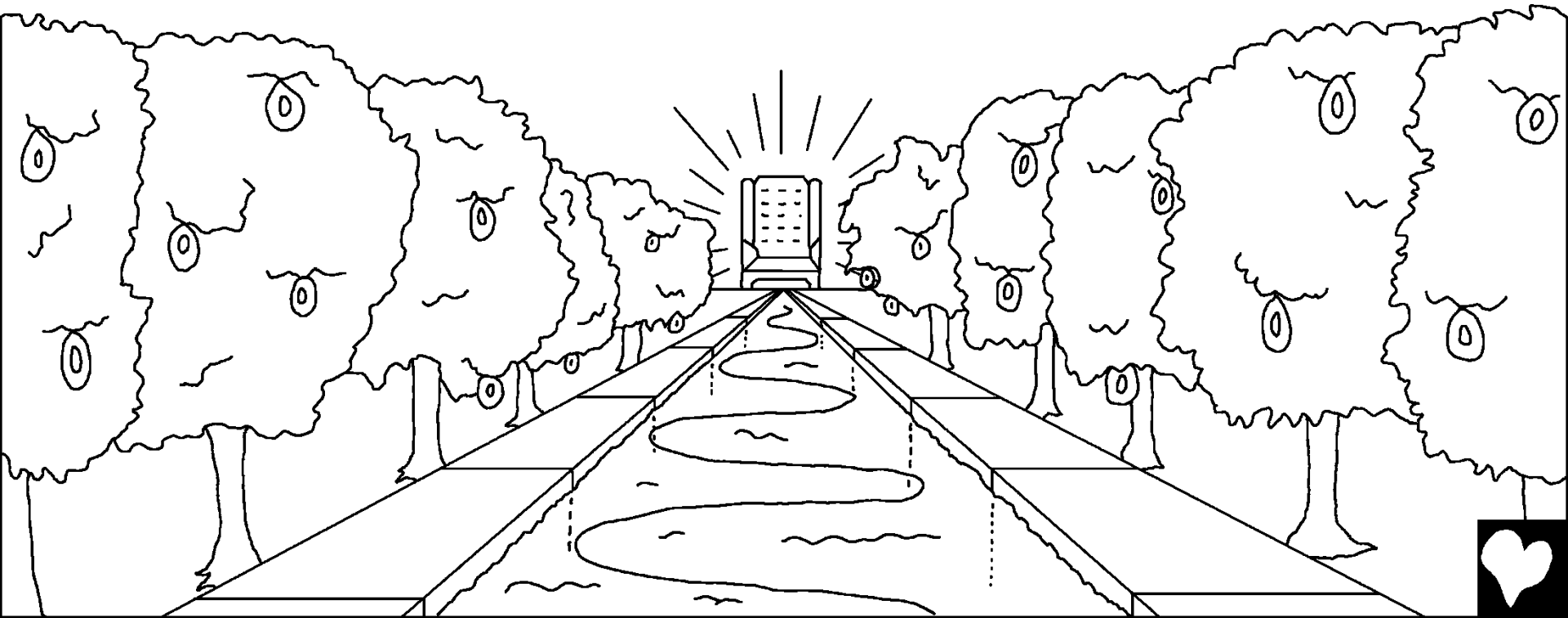

Ituni kuyendaa sua kana mwai kwona kyeni. Ngai niwe mwene ukumyo ula usuasya kyeni kitheu vau vai utuku ona umwe.

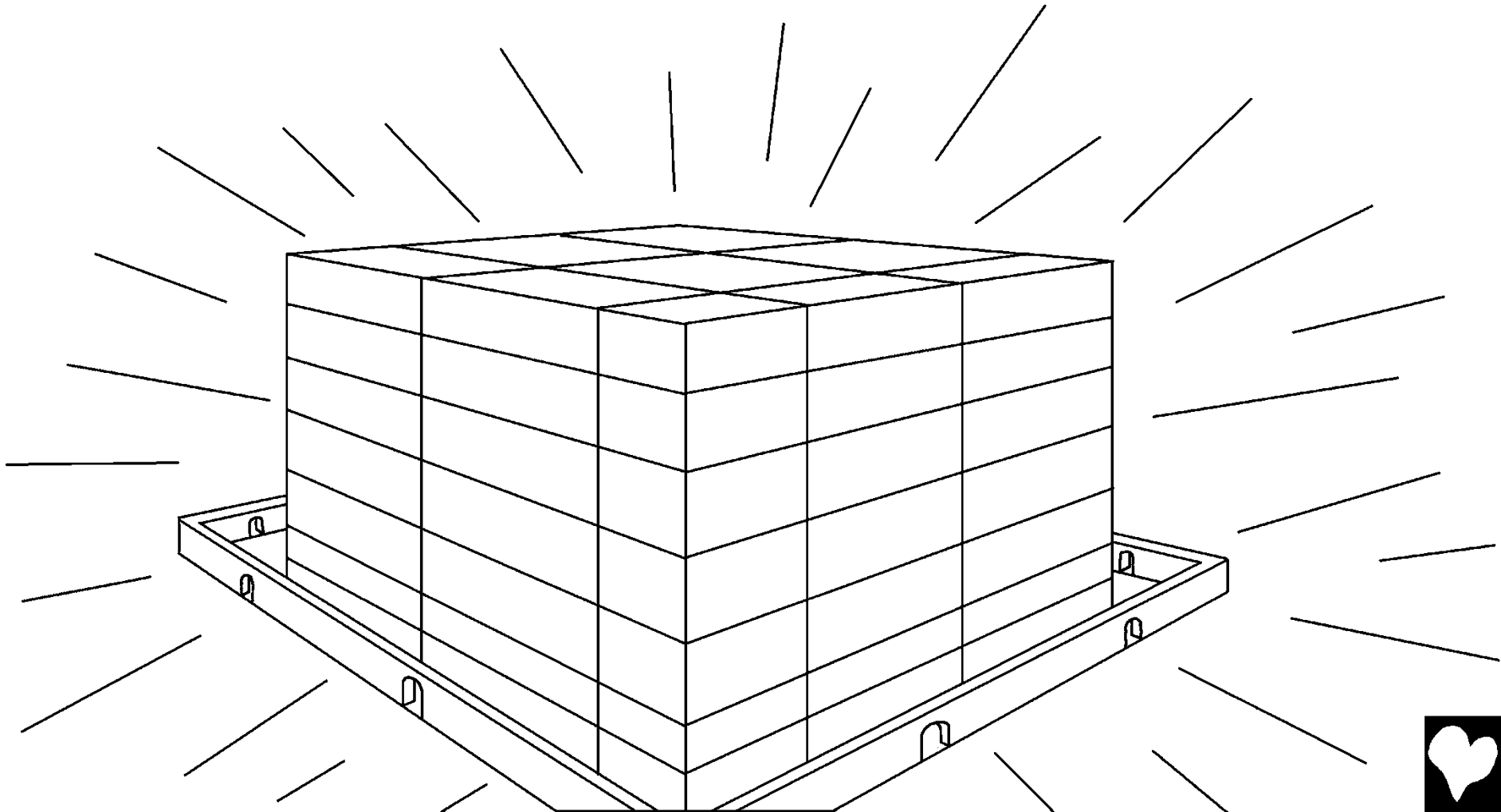

Ona nyamu ituni nisya kivathukanyo muno syonthe ni mbuu na nisyendanite. Mbiwa na tulondu syiisya nyeki vamwe. Ona munyambu mukie muno uisaa vamwe na ngombe sya mulau. Na Mwia aasya, "iikaumanwa kana kwananga iima syake ntheu."



Tuisisya kila ngaliko, nitwona syindu itevo ituni.
Ndukewa ndeto nthuku, vai mundu ukita na ungi kana
kwiyenda. Vai ivuli miomoni nundu kui ingei ituni.

Vai akengani,
owani, aoi,
na andu
angi
athuku.
Vai
thavu
ituni.



Twina Ngai ituni kuikethiwa methoi ingi. Mavinda amwe andu ma Ngai nimaia nundu wa woo mwingi wa maisha ma nthi ino. Kuya ituni Ngai akavangula methoi oonthe.



Kui kikwu ituni. Andu ma Ngai makekela tene na tene vamwe nake. Vaikethwa kiio, Kiwoyo kya ngoo, na kuikethwa woo. Kuikethwa mauwau, kutiwa, na mathiko. Kila mundu ituni akewaa muyo vamwe na Ngai.



Useo ula wivo, uu ni imwana na eitu (ona andu ala aima) ala mamuikiie Ngai ta mwiai woo na kuatiia miao yake. Kuya ituni kwi ivuku yitawa ivuku ya thayu. Yusiite masyitwa ma andu. Niwisi masyitwa ala maandikitwe vau? Ni masyitwa ma andu ala meekie wikwatyo woo vala ve Yesu. Isyitwa yaku ni vau?

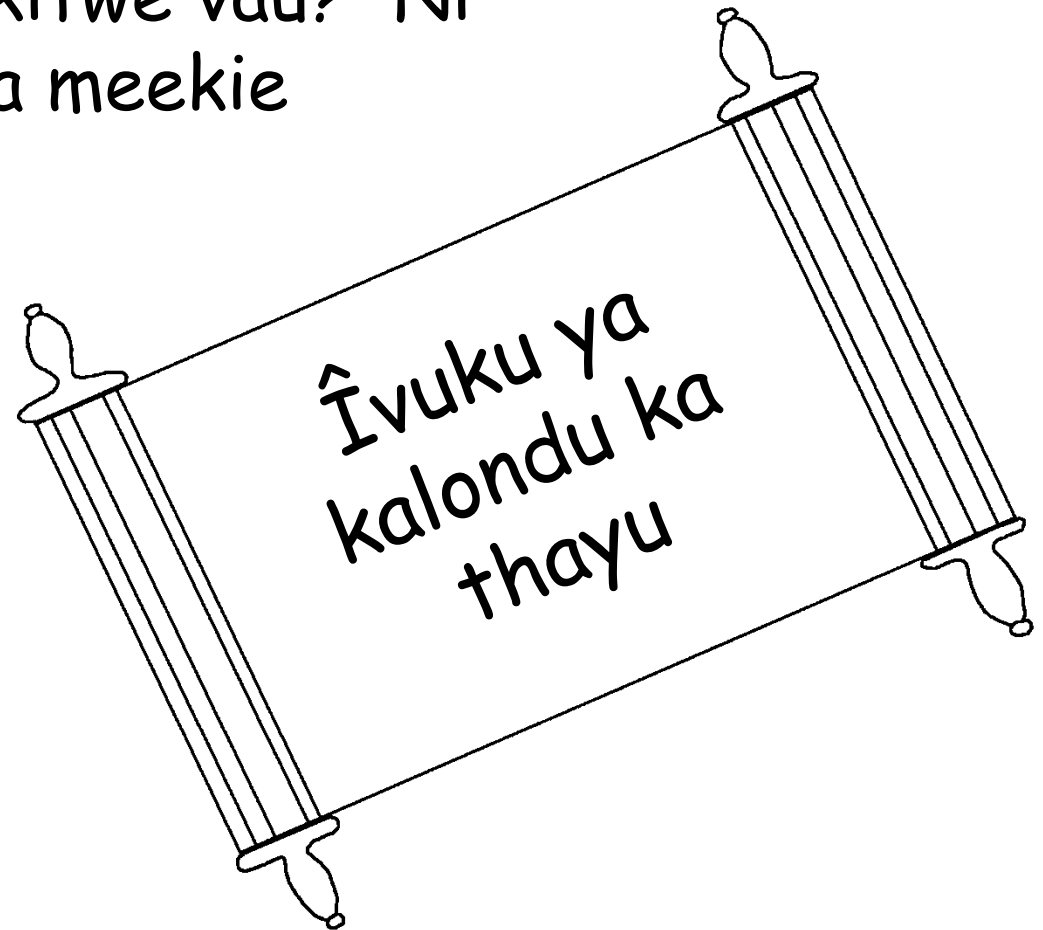

Ndeto sya muthya sya Mbivilia ni kuthokwa kwa mwanya. "Na veva na mutwawa masya, 'Ukai!!' na ula wiiwa ni asye, 'uka' na ula wina wauni oke, oke ose kiwu kya thayu mana."



Ituni musyi mwanake wa Ngai

Ngewa kuma kwa ndeto ya Ngai, Mbivilia

Yonekanaa

Yohana 14; 2 Akolintho 5;
Uvuanwo 4, 21, 22

“Kulika kwa ndeto yaku kûetae kyeni.”
Savulî 119:130



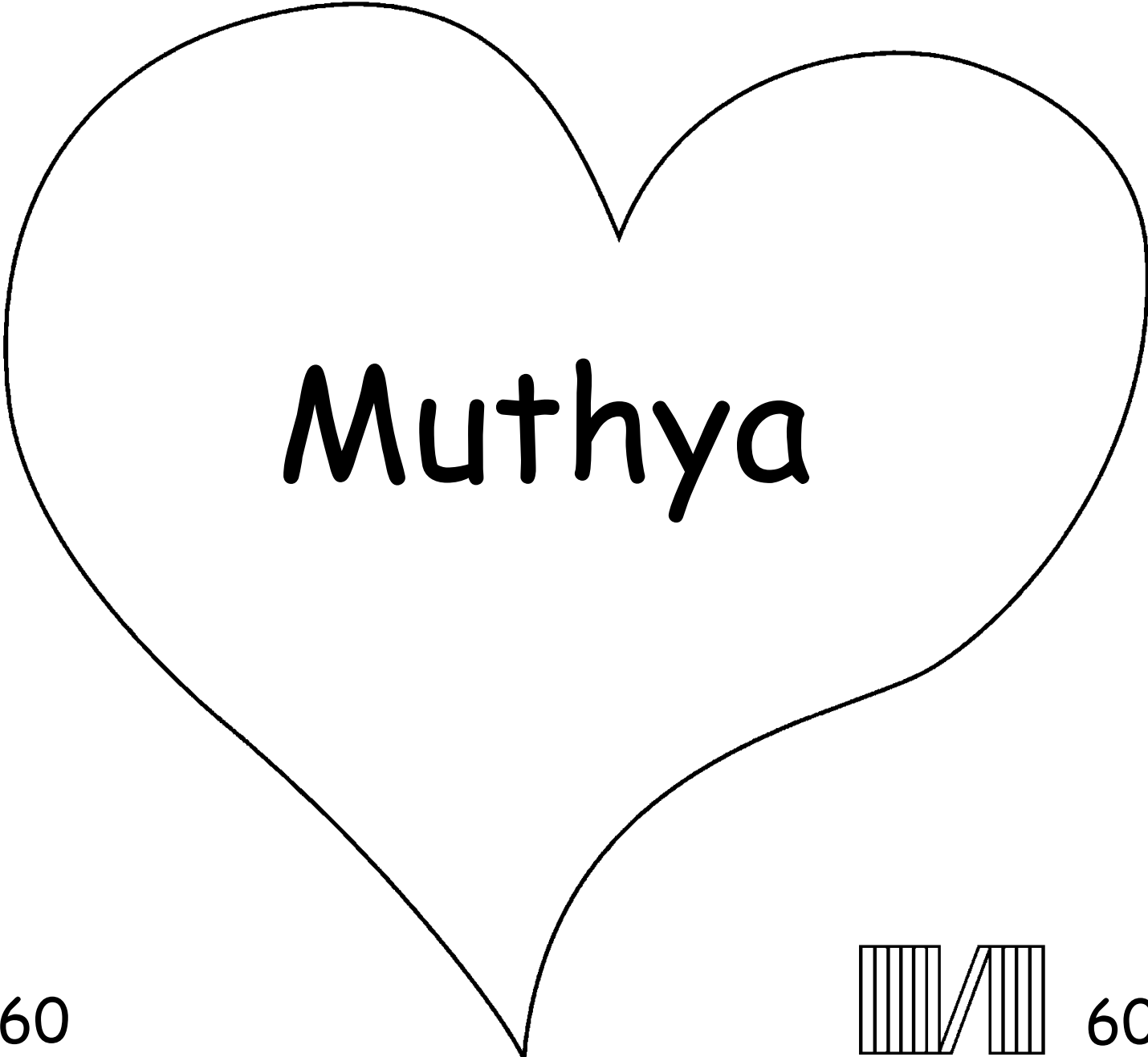

Muthya

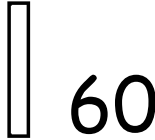

60



Ngewa ino ya Mbivilia îtutavasya yiûlu wa
Ngai witu wa ûseny' o ûla watumbie na ûla wendaa ûmumanye.

Ngai niwisi kana nitwikite maûndû mathûku ala we ûmetaa naî.

Usilîlo wa naî ni kîkw' û, indî Ngai nûtwendete mûno nûndû
nîwatûmie mwana wake ûmwe, Yesu Klisto akw' e mûkelany' oni na
asilîlwa nûndû wa naî syaku. Na indî Yesû nîwasyûkie na asyoka
îtunî îngî! Ethîwa nûûmûîkîia Yesu na ûimûkûlya akûekee nai
syaku, nûkwîka ûû! Nûkûka na akîkala nthînî wakû yu,
na ûkekala nake tene na tene.

Ethîwa nûîkîia kana ûu niw' o, neene ndeto ii kwa Ngai: "Yesû
mwendwa, nîngûîkîia kana wî Ngai ûla watwîkîe mundû, akwa
kwoondû wa naî syakwa, nayu ni wikalaa thayû îngî. Mwa, ûka
thayûnî wakwa na ûindekea naî syakwa nikana mûthenya ûmwe
nîthi îtunî nîthîwe naku tene na tene. Ndehaye nîkwîw' ae
we na ndyikalaa naku ta kana kaku". Ameni.

Somaa Mbivilia na kûneenaa na Ngai kila mûthenya!
Yoana 3:16

