

Bibilia kwa ahoho

Inakurehera

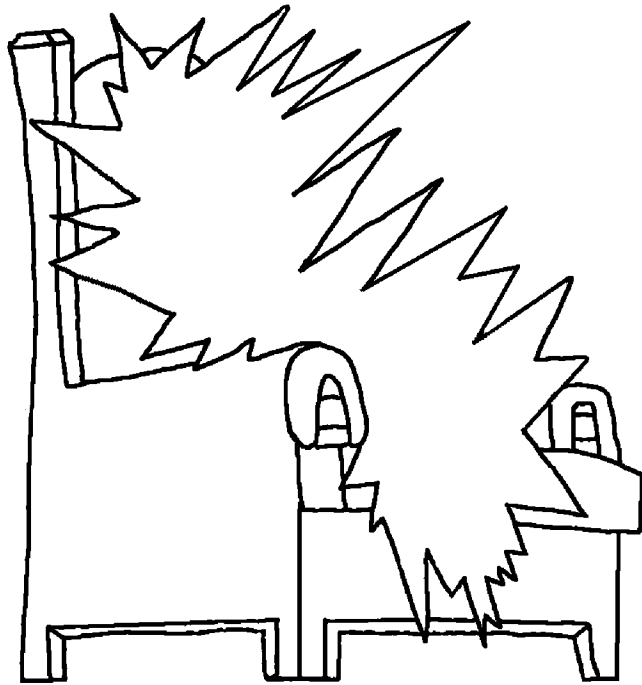

Mulunguni,
Mudzi
uthana wa
Mulungu



Yaandikwa ni: Edward Hughes

Yaelezerwa ni: Lazarus
Alastair Paterson

Ya halwa ni: Sarah S.

Ya tafusiriwa ni: www.christian-translation.com

Ya tengezwa ni: Bible for Children
www.M1914.org

©2021 Bible for Children, Inc.

Chibali: Una haki ya kukala na Nakala
ama kuchapisha ngano yiyi.



Jeso ariho ishi haha duniani, waambira o anafunzi
kuhusu Mulunguni. Wakwiha, "Nyumba ya Baba",
gonya akiamba kuna madzumba
manji sana kuko. Dzumba ni
nene, thana. Mulunguni
ni kuthana zhomu
kuriko hathu hosini
haha duniani.

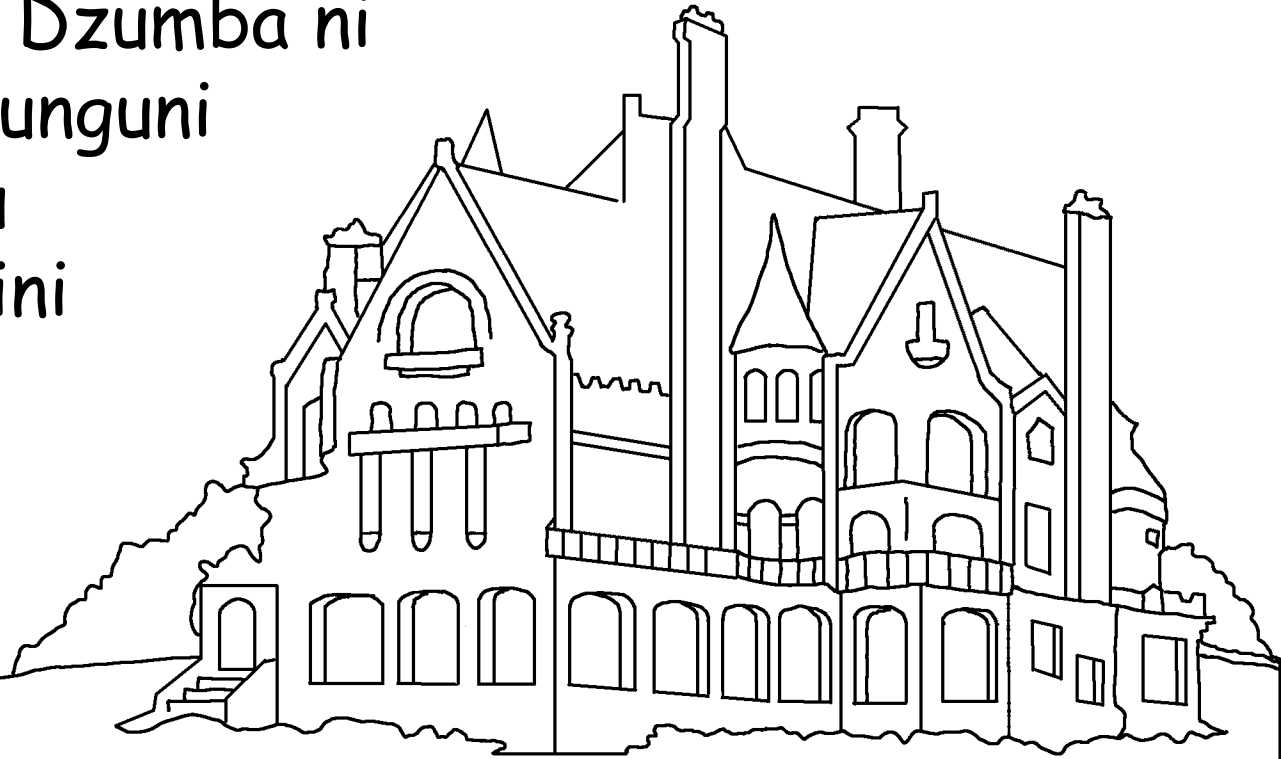

Jeso akiamba, "nendza zangu kuthayarisha hatu fa ninwi, ndadza keheri ili ni ahokere mimi." Gonya Jeso achenda Mulunguni, baada ya kufufuka kumbola kwa afu. Anafunzi akwake achilola, Jeso wahalwa dzulu, vikara kaingu kakimhokera mbere ya matso gao.

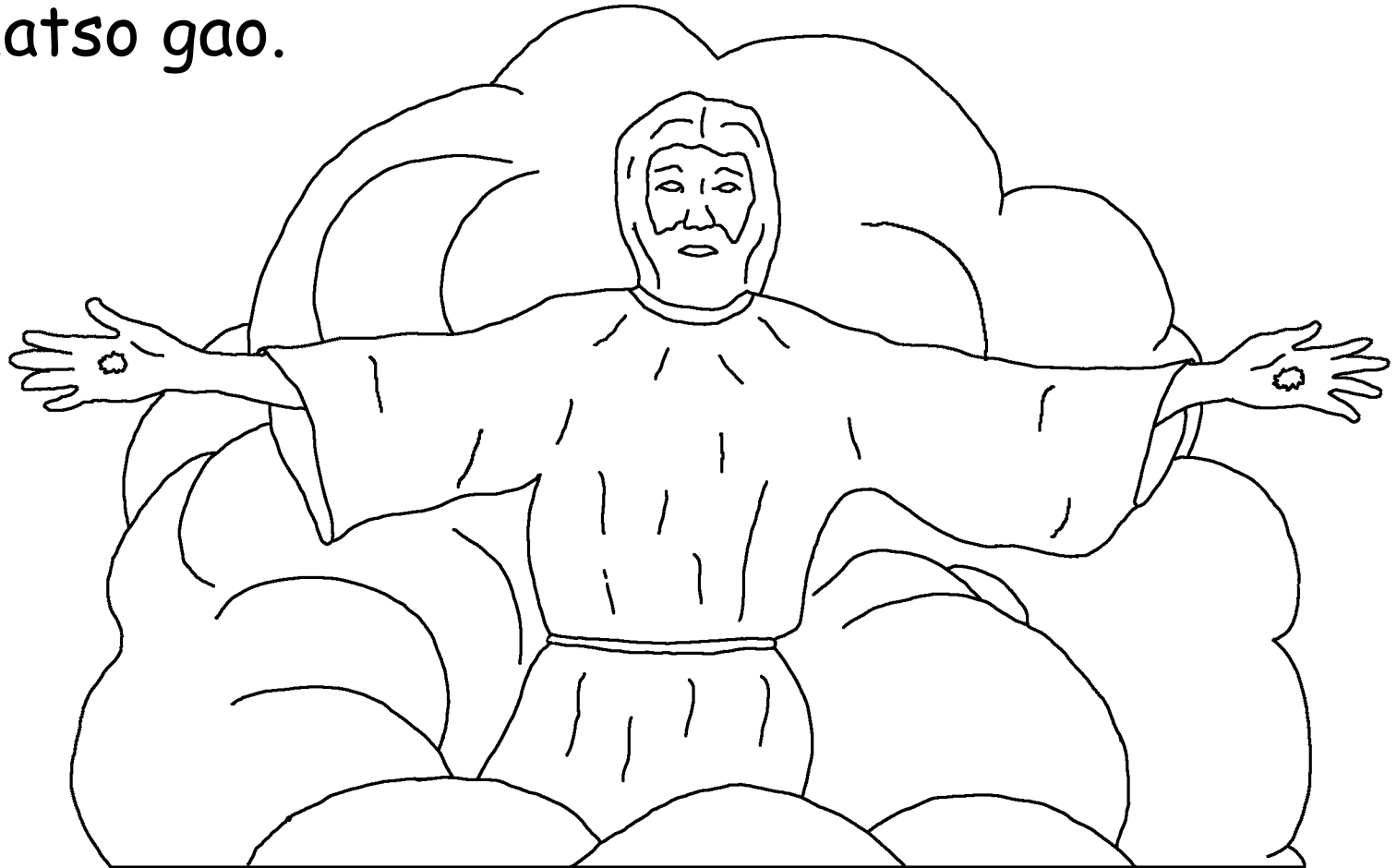

Hangu haho, Ajeso manakumbikira ahadi yiyo kukala
Jeso anadza afuhale siswi. Lakini je o Ajeso afwao
kabila Jeso kudza? Bibilia rinamba, ao
anenda tititi kukala na Jeso.

Kumbola kahiza mwiri ni
kukala na Jeso.

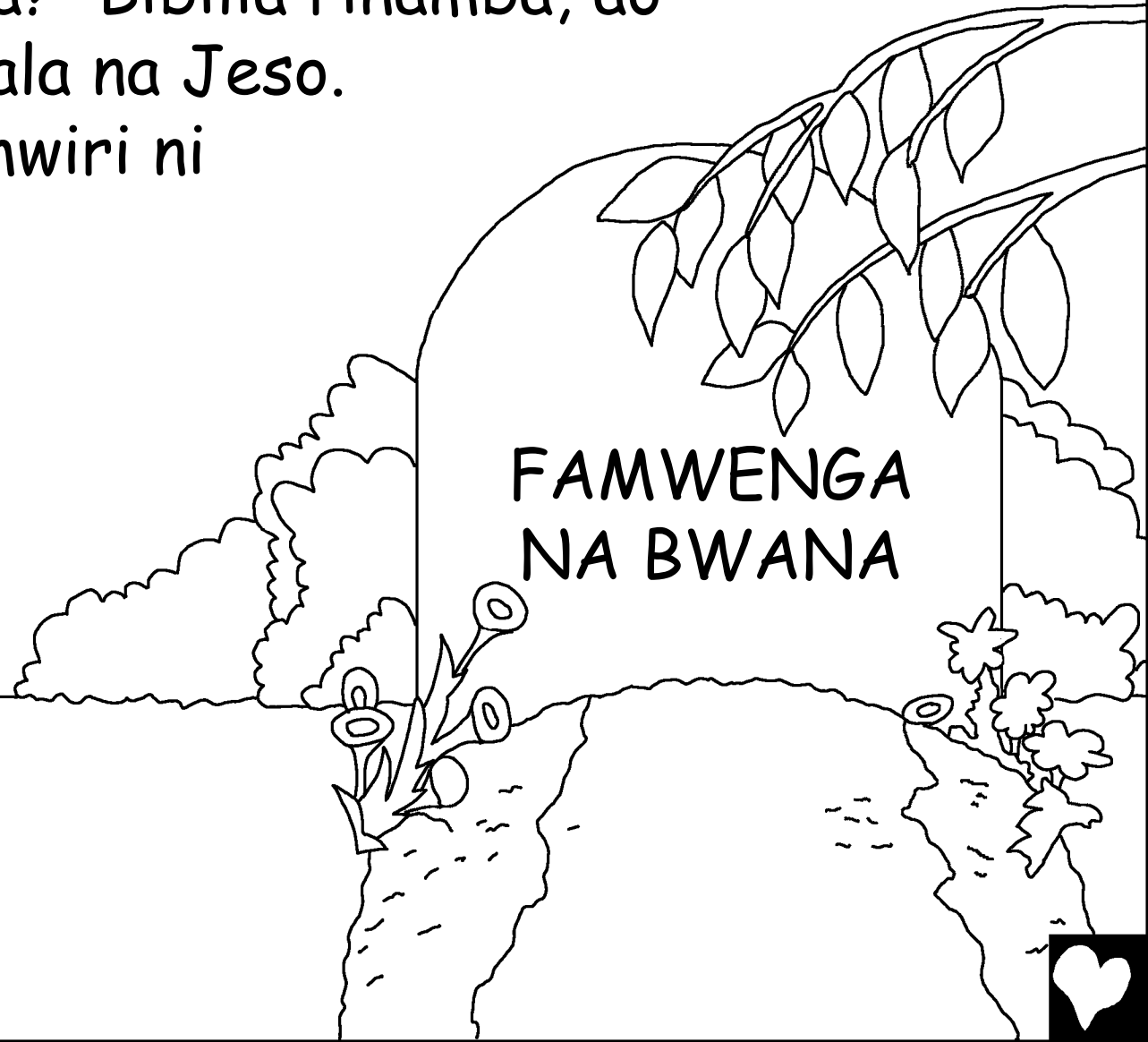

Ufunuo, kithabu cha Mwisho cha Biblia, kinanena kurizho kwa Ajabu ko Mulunguni. Kitu kidzo Zaidi ni, kahiza ngira ya hakeye, Mulunguni ni Nyumbani kwa Mulungu. Mulungu a`kila hatu, Lakini kihiche ki Mulunguni.

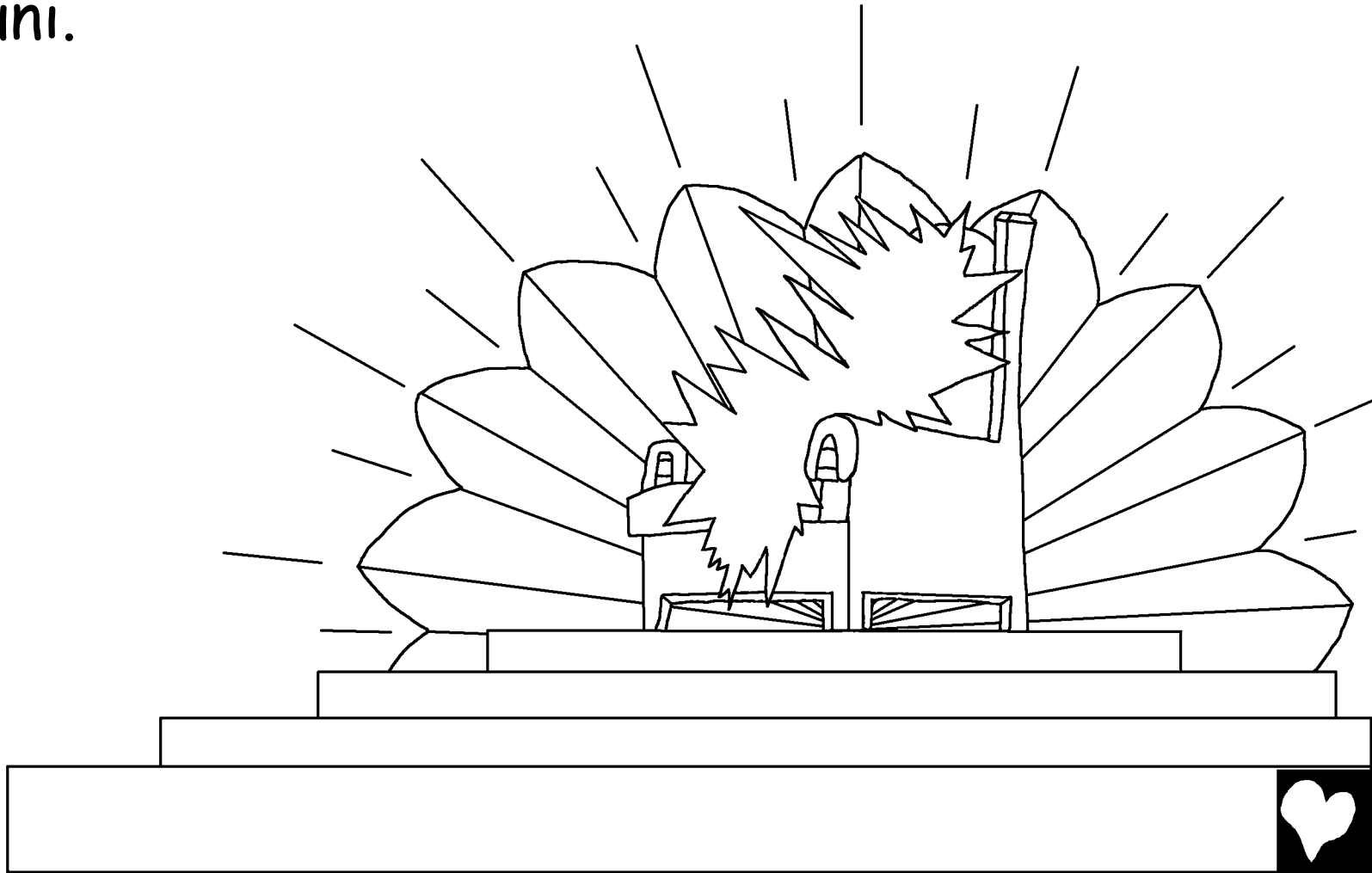

Malaika na viumbe Vinjine vywa Mulunguni,
Vinamwabudu Mulungu ko Dzulu. Atu
a Mulungu mario afa vizho.
Manaimba mira ya ajabu
ya kuthukuza Mulungu.



Gaga ni Maneno ga wira umwenga ambao anaimba
kuko: UNASITAHILI MAANA WAHOKOLA
SISWI KWA MULUNGU
KUKIRIRA MULATSO WA
KWAKO CHIKA KABILA NA
NTSI NA UDZIHUHENDA
AFALUME NA
AKUHANI
KWA
MULUNGU
WEHU.
(Rev. 5:9)



Ukurasa wa Mwisho wa bibilia unaamba Mulunguni ni "mudzi usha wa Yerusalemu". Ni nene, zhomu, ina ukutha ure ko nze. Uo ukutha ni maiwe ga mulat'so, nyeruhe here kilolo. Kitho na maiwe ga thamani ndio musinzi wa uo ukutha. Ina metha metha na rangi tofauti. Kila muryango wa ro ryango nene wathengezwa na lulu nene zhomu.

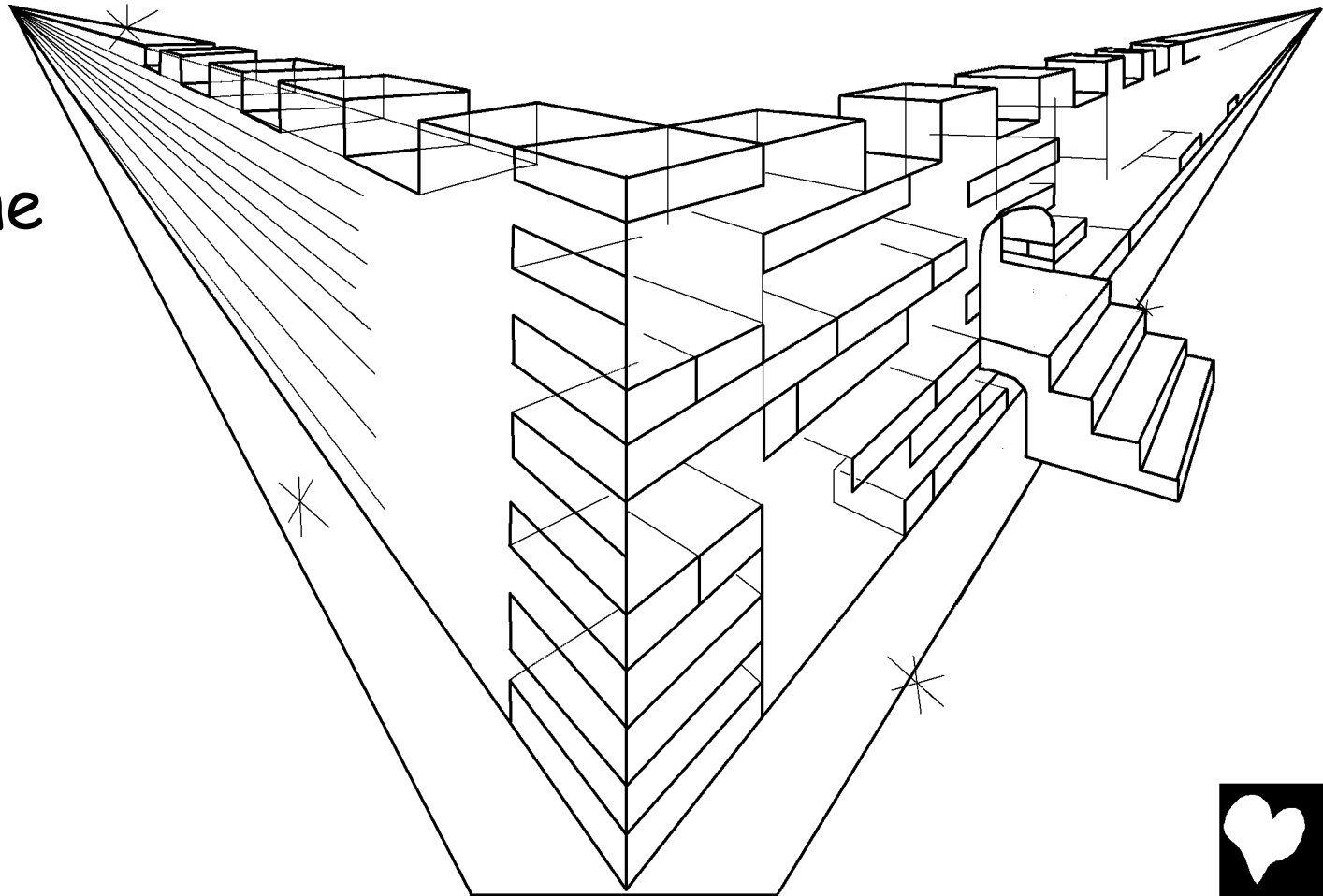

Yo muryango ya lulu kayifungwa. Nafungire ndani fwoneni...ONA! Mulunguni ni kuthana hasa kuko ndani. Uo mudzi wathengezwa na dhahabu hakeye, here kilolo. Tha zho ngira ni dhahabu.



Kuthana, myeha ya madzi kulahiza kihi cha Mulungu. Upande munjine ni muhi wa uzima, urio kala wa kwanza mundani Edeni. Muhi u`u ni wa hakeye. Unazhala mahunda kumi na mairi tofauti, tofauti kila mwezi. Gonya go makodza ga uo muhi ni ga kuhoza mataifa.

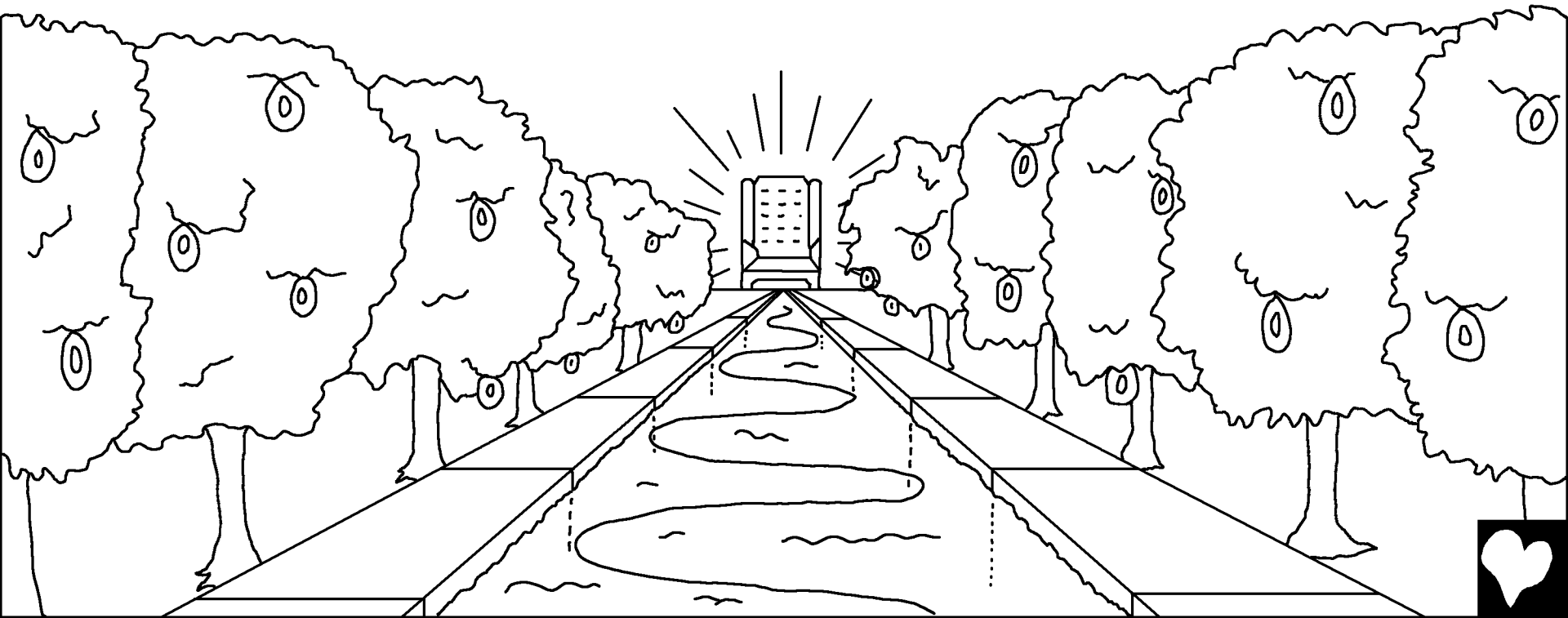

Mulunguni kakuhitaji dzuwa ama mwezi kwa
mwangaza. Utukufu wa Mulungu ambao uthele
Mulunguni unaudzasha Mudzi uo na mwanga wa ajabu.

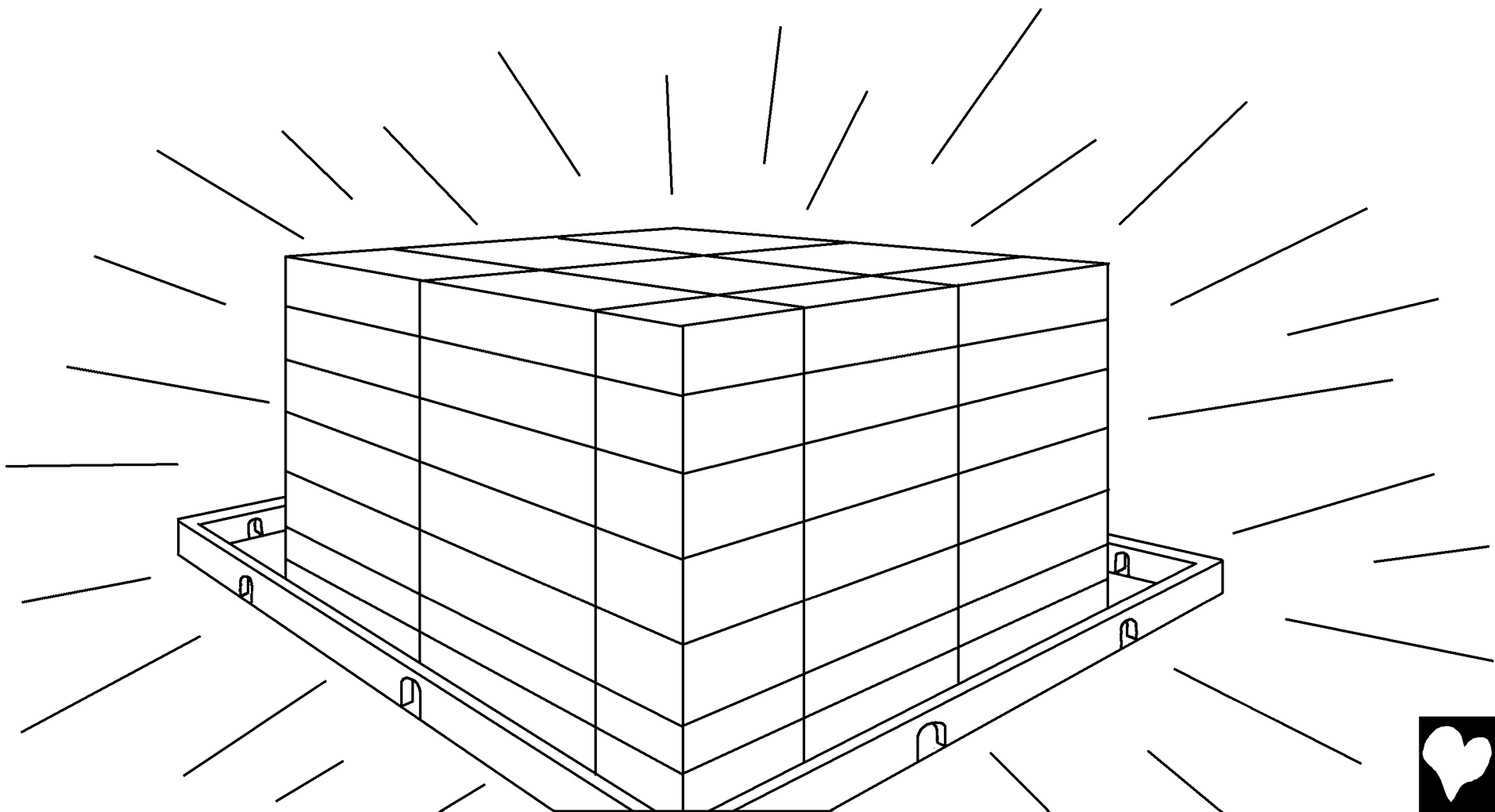

Anyama ko Mulunguni Atofauti. Ni asena, kuogosha.
Makuro ga weruni na Magonzi arya nyasi famwenga.
O tsimba na ng`ombe arya famwenga makodza ga
mihi. Bwana anaamba, "Kamanda dhuru wala kunonga
kahiza chirima changu chitakatifu."



Fuchilola, funaona kuna
vitu vinakosa Mulunguni.
Kakuna Maneno Makali
kuko. Kakuna kondo
kuko ama atu kudzona
ao tu. Kakuna chabi
mo miryangoni,
mana kakuna aivi
ko Mulunguni.
Kakuna atu akukenga,
akulaga, alogi ama
atu aovu kuko.
Kakuna zambi kuko.



Mulunguni na Mulungu, kakuna
bule matsozi kuko. Wakathi
munjine, atu a Mulungu
manarira kwa sababu ya
thabu na mateso kahiza gaga
maisha. Mulunguni, Mulungu
andafuta matsozi gehu gosi.



Kakuna kufa ko Mulunguni, kakuna kabisa. Atu a
Mulungu andakala naye milele. Kakuna Huzuni
kaheri, kakuna kurira, kakuna u'tsungu. Kakuna
makongo, kakuna
kurichwa, kakuna
mahanga. Kila
mutu anafurahia
na Mulungu milele.



Dzulu ya kila kitu, Mulunguni ni kwa mabarubaru na asichana (atu odzikomala pia) mario amini Jeso Kirisito here Mwokoli wao na amwamini here Bwana wa kwao. Mulunguni, kuna kithabu kinaifiwa, kithabu cha Muhoho wa gonzi. Kithele madzina ga atu. Je unamanya ni madzina gano ani garigo ndikwa ko? Atu osini ario mutumaini Jeso.

Je dzinare ri kuko?



Maneno ga Mwisho ga Bibilia kuhusu Mulunguni ni
Maneno ga mwaliko ga ajabu. "Ye roho na mwana
harusi unaamba, 'Nzo!' Na yeyosi asikiraye na
'Adze!' Ariye na chiru na adze. Na yiye athamaniye,
Na adze ahale madzi ga uzima bule."



Mulunguni, Mudzi uthana wa Mulungu
Ngano kulaa kwa Neno ra Mulungu, Bibilia,
Inapatikana

Johana 14; 2 Korintho 5;
Ufunuo 4, 21, 22

"Uhenyo wa Maneno ga kwako gana reha
mwangaza." Zaburi 119:130



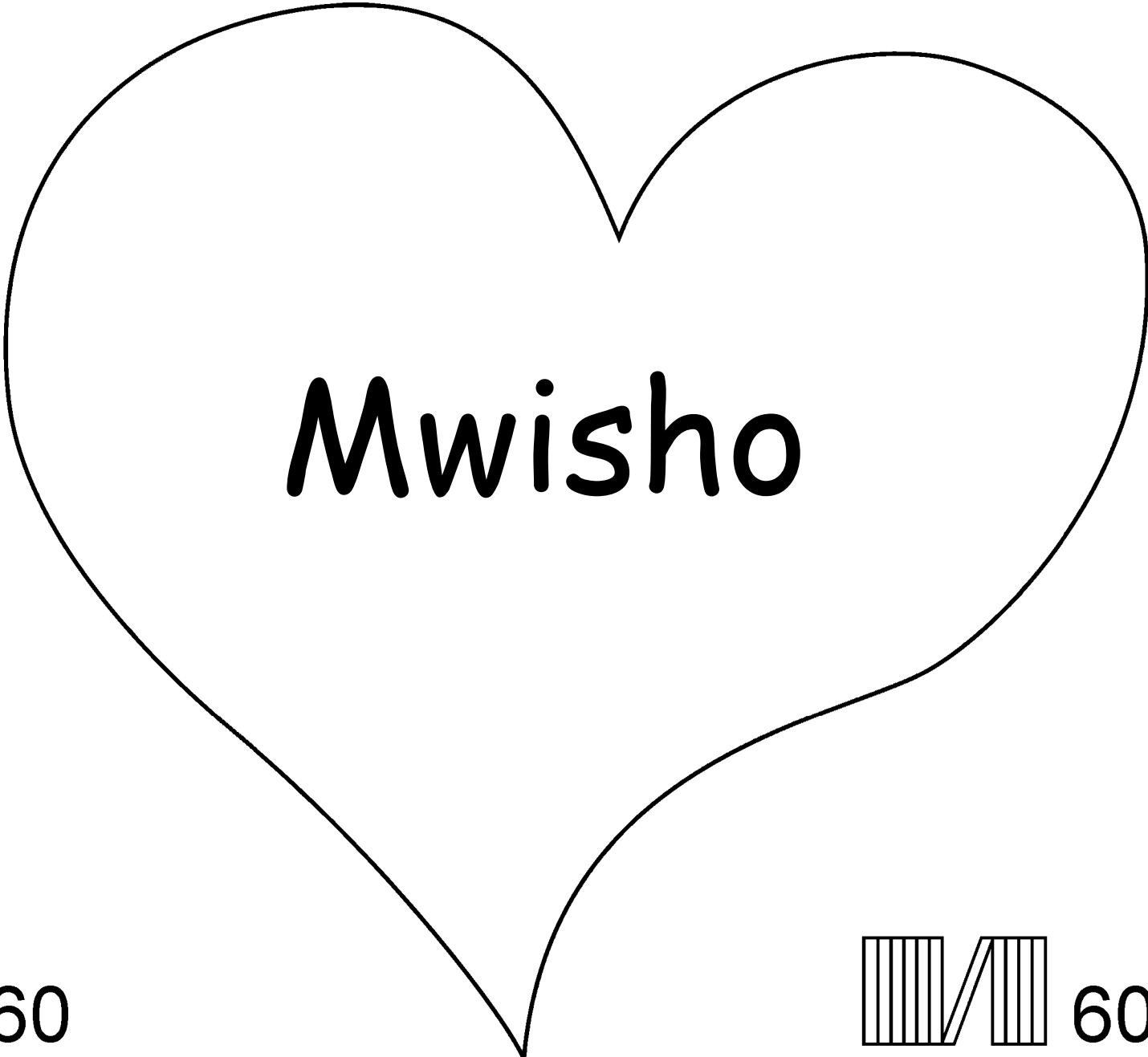

Mwisho

| 60

||||| 60



Ngano zizi za bibilia, zinasumurira dzulu ya Mulungu, arivyo wa ajabu, ariye huumba, gonya anamala fumumanye.

Mulungu anamanya kukala psiswi fwahenda mai, ambazyo anaziha Dambi. Adabu ya dambi ni chifo, lakini Mulungu anahuzenza zhomu here akilazsha muhoho wa hakeye, Jeso, afe musalabani ili akale yo adabu ya dambi za kwako. Gonya Jeso akifufuka na akienda Mulunguni! Vikara ukimwamini na umwambire akusamehe dambi za kwako, andakusamehe! Andakudza aishi na uwe vivi, na undaishi naye milele na milele.

Gonya kikala unaamini u ujeri, umwambire Mulungu vivi: Jeso, naamini kukala uwe u Mulungu, Wakala mutu, ukifa kwa ajili ya dambi za kwangu, na vivi unaishi keheri. Nakuvoya nzoo maishani mwangu na unisamehe dambi za kwangu, ndo nikale na maisha, na siku mwenga nikale na uwe milele na milele. Nisaidia nikweshimu, na nikwishire here muhoho wa kwako. Amina.

Shoma Bibilia vikara u nene na Mulungu kila siku! Johana 3:16

