

Ibuku rĩa Ngai kũrĩ ciana
nĩrĩrakũrehera

Jona na
Thamaki
Nene



Rwandĩkĩtwo nĩ: Edward Hughes

Rũthathaũrĩtwo nĩ: Jonathan Hay
Alastair Paterson

Rũharĩrĩirio nĩ: Mary-Anne S.

Rũtaũrĩtwo nĩ: Stephen Kimani

Rũtungĩtwo nĩ: Bible for Children
www.M1914.org

©2022 Bible for Children, Inc.

Rũtha: Nĩwĩtĩkĩrĩtio kuruta kana gucabithia rũgano rũrũ,
angĩkorwo ti rwa kwendia.



Mĩaka miingi tene, mũndũ weetagwo
Jona aikaraga bũrũri wa Isiraeli.
Mũthenya ũmwe Ngai akĩmwĩra
athĩ Nineve, itũũra rĩrĩa
rĩarĩ inene biũ na rĩa
hinya kũrĩ
matũũra

mothe
ma thĩ.

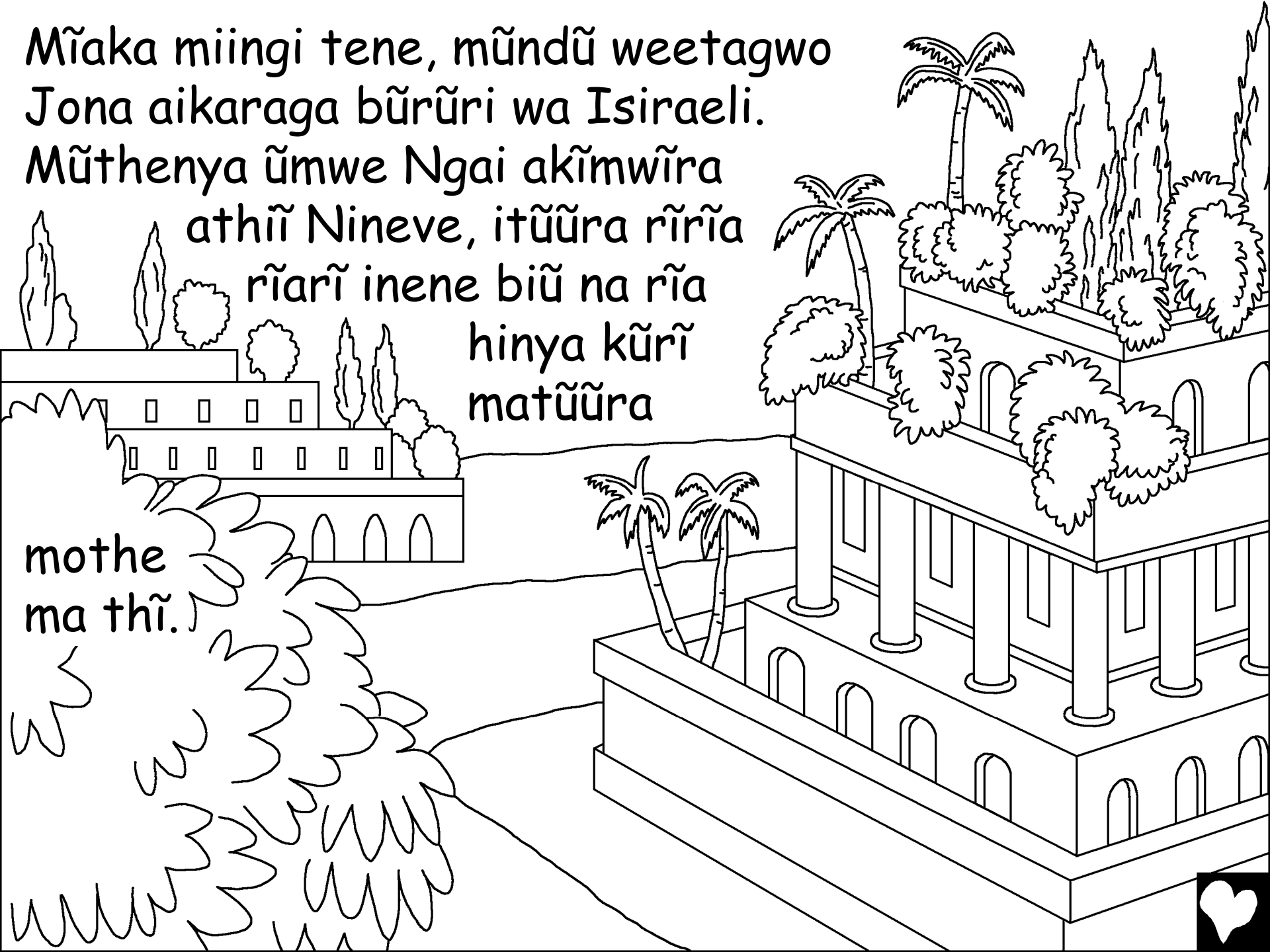

Jona aarī akanie andū a kūu atī
Ngai nioī ūrīa waganu wao waarī.

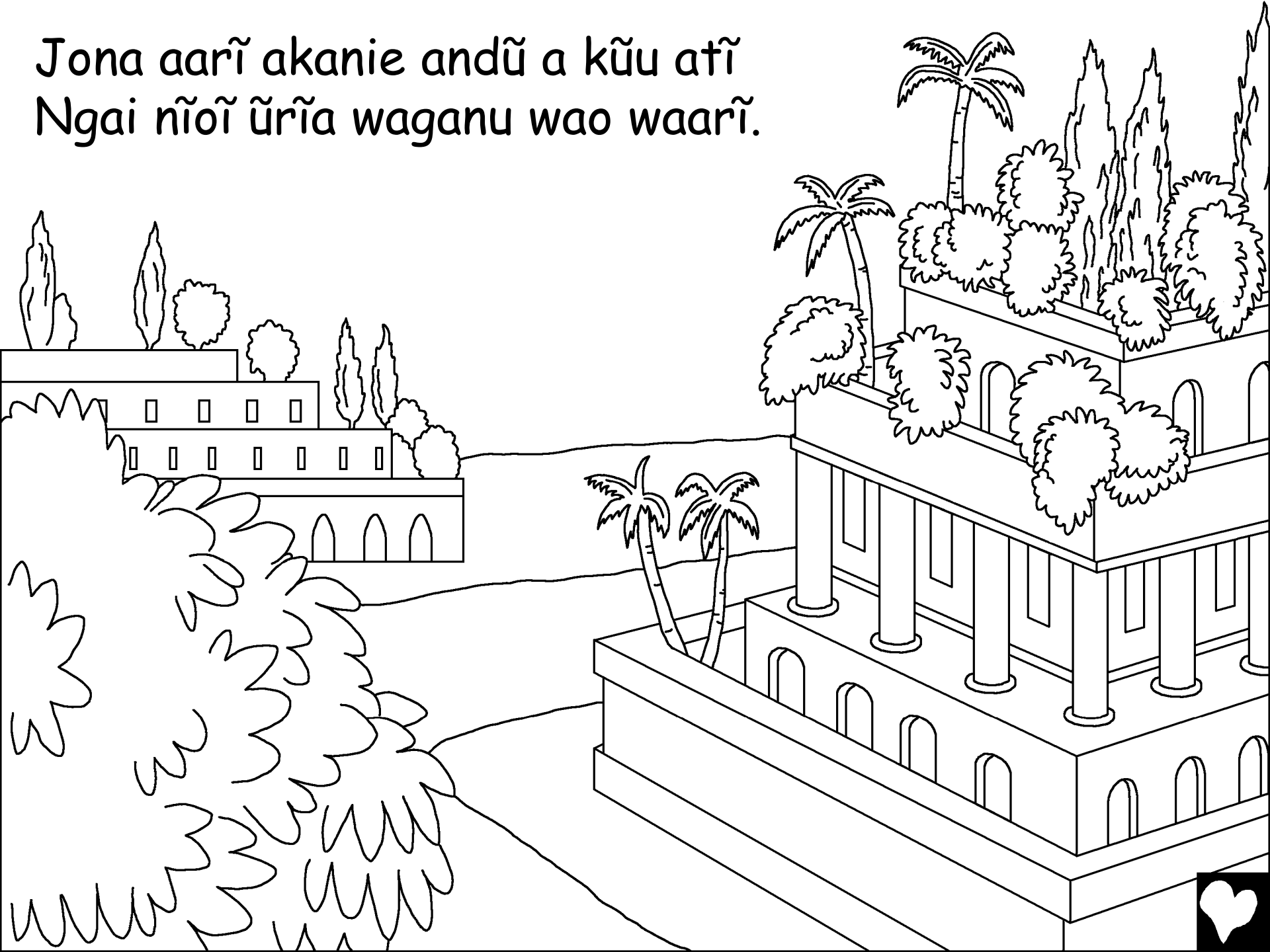

Jona agĩkararia Ngai! Handũ ha
gũthĩĩ Nineve, Jona akĩingĩra
marikabu na agĩthĩĩ mwena ũcio
ũngĩ kũndũ gwetagwo Tarishishi.



Ngai agītūma rūhuuho rūnene iriainī. Gūkīgĩa na
kīhuhūkano kīnene! Atwarithia a marikabu
magīitigīra nogūkorwo marikabu nīgwatūka na
yūūrīre maāinī.

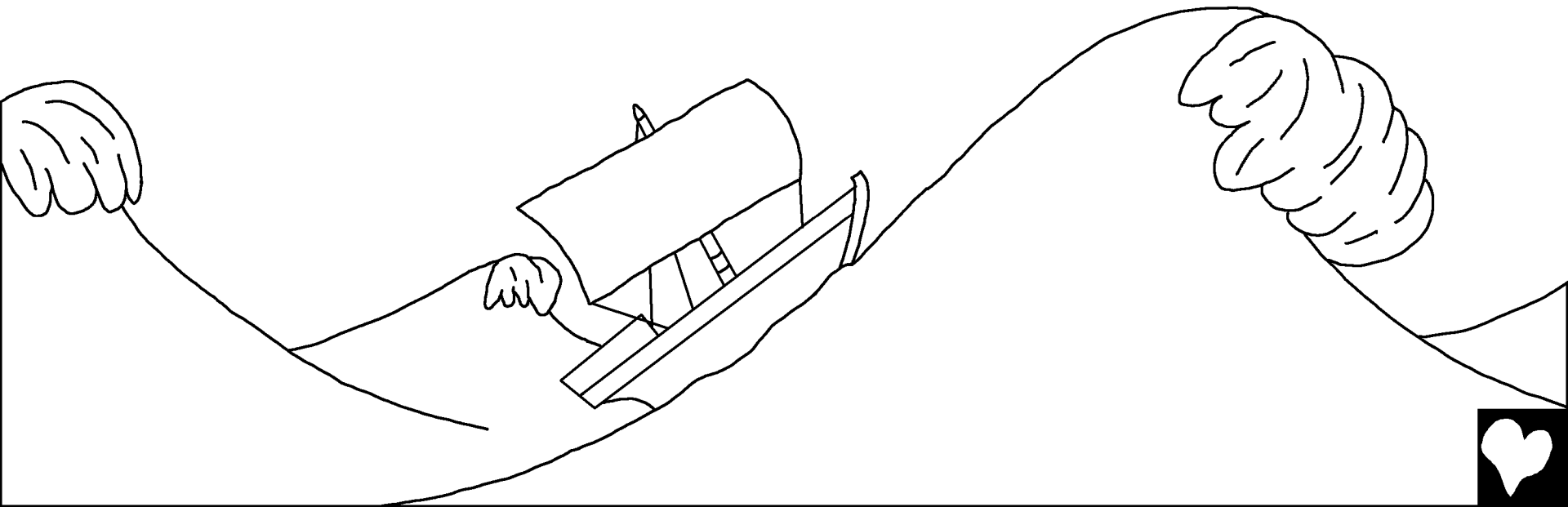

Kihuhũkanio gĩkĩneneha. Marĩ na guoya atwarithia a marikebu makĩhooya ngai ciao na magĩikia mĩrigo maaĩnĩ nĩgeetha marikabu ãhũthe. No hatirĩ ũndũ wateithagia.



No Jona tu ũtaahoyaga marikabuiniĩ. Handũ ha ũguo
nĩ gũkoma akomeete toro mũritũ. Mũnene wa
marikabu akĩmũkora. "Nĩ kĩĩ ũreeka ũkomeete?
Ũkĩra! Hooya Ngai waku! Nogũkorwo Ngai
nĩagũtwĩciria, aage gũtũniina."

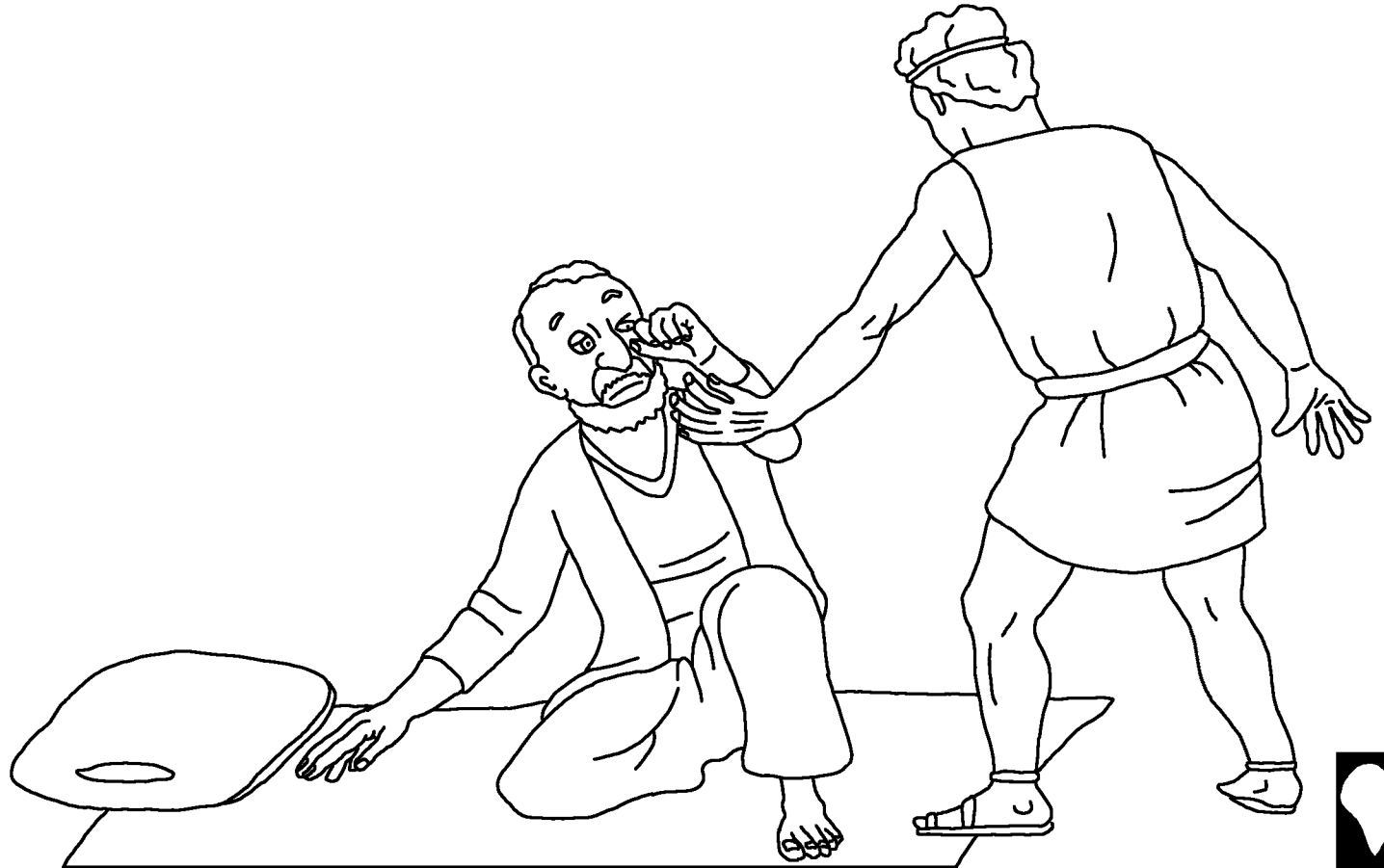

Atwarithia a marikabu makĩigwithanĩria atĩ mathĩina mao maũmanĩite na Jona. Akĩmeera atĩ nĩ kũũrĩra oragĩra MWATHANI. Makĩũria, "Tũgwĩke atĩa, nĩguo iria rĩhoorere?" Jona akĩmacokeria, "Njoyaai mũnjikie iriainĩ. Tondũ ndĩ na ma atĩ nĩũndũ wakwa kĩhuhũkanio gĩĩkĩ kĩmũũkĩire."

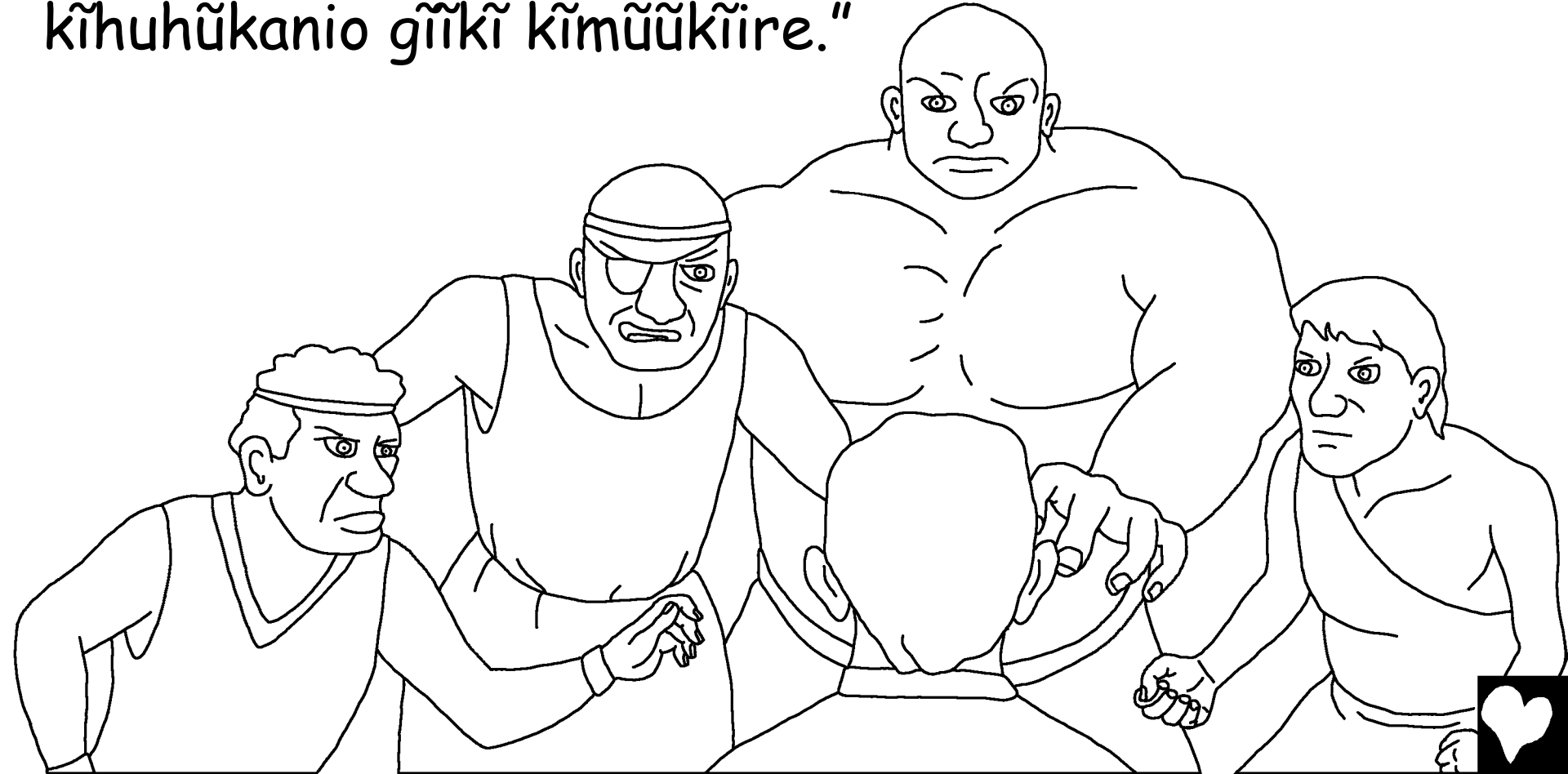

Atwarithia a marikebu
matiendaga gũikia
Jona maaĩnĩ. Kwoguo
makĩgeria gũtwara
marikebu hakuĩ na
thĩ nyũmũ. No
matingĩahotire.
Haarĩ na ũndũ
ũmwe tu wa
gwĩka!

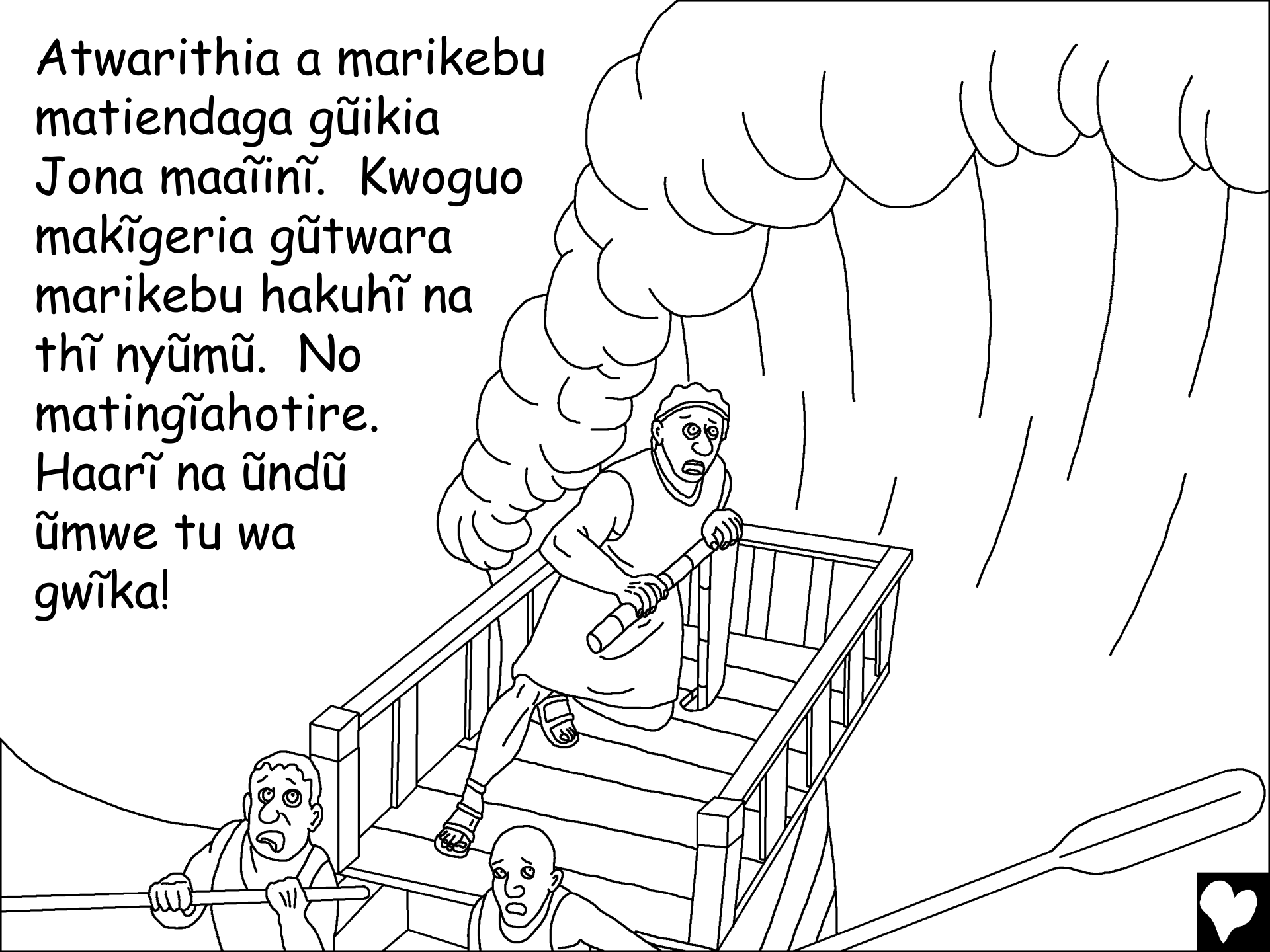

Thuutha wa kũhooya moherwo, atwarithia
a marikabu makĩoya Jona

na makĩmũikia
maaĩnĩ. Rĩrĩa
Jona ooragĩra
maaĩnĩ iria

rĩkĩhoorera na rũhuho
rũgĩthira. Gũcenjia kwa rĩera o
rĩmwe gũkĩmakia atwarithia a
marikabu gũkĩra kĩhuhũkanio

kĩu. No nginya nĩmamenyire
atĩ no Ngai ũngĩahotire
gwĩka ũguo. Marĩ na

guoya na kĩmako,
magĩthathaiya
MWATHANI.



Nayo ndungata ñno ya
gũkararia ñkĩamũkĩra
ũndũ wa kũmakania.
Rĩrĩa atonyagĩrĩa
maaĩnĩ atarĩ na
ũteithio, Jona
akĩmenya
gũtirĩ ùndũ
ũngĩamũteithirie
ndagakue.
Nĩangĩakuire
maĩnĩ, no Ngai aarĩ
na mĩbango ingĩ.

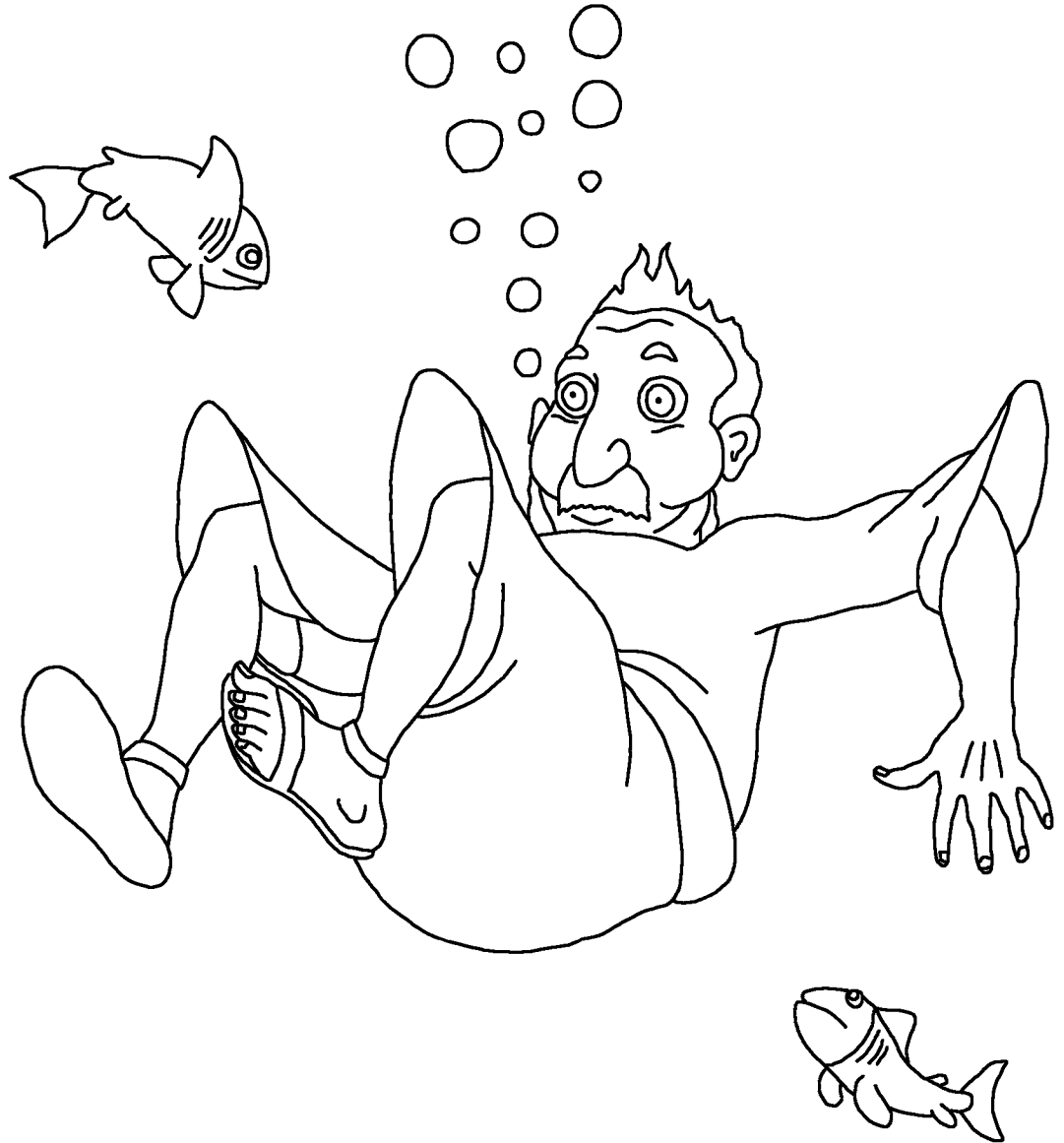

Ngai n̄iaharĩrĩirie thamaki nene ĩmerie Jona.
Thamaki ĩyo yaarĩ ho ihinda rĩega! Imeria rĩmwe
na Jona akiuma iriainĩ na akĩingĩra nda
ya thamaki. Jona agĩikara thĩinĩ wa
thamaki thikũ ithatũ. Aarĩ
na mahinda maingĩ ma
gwĩciiria na kũhooya.

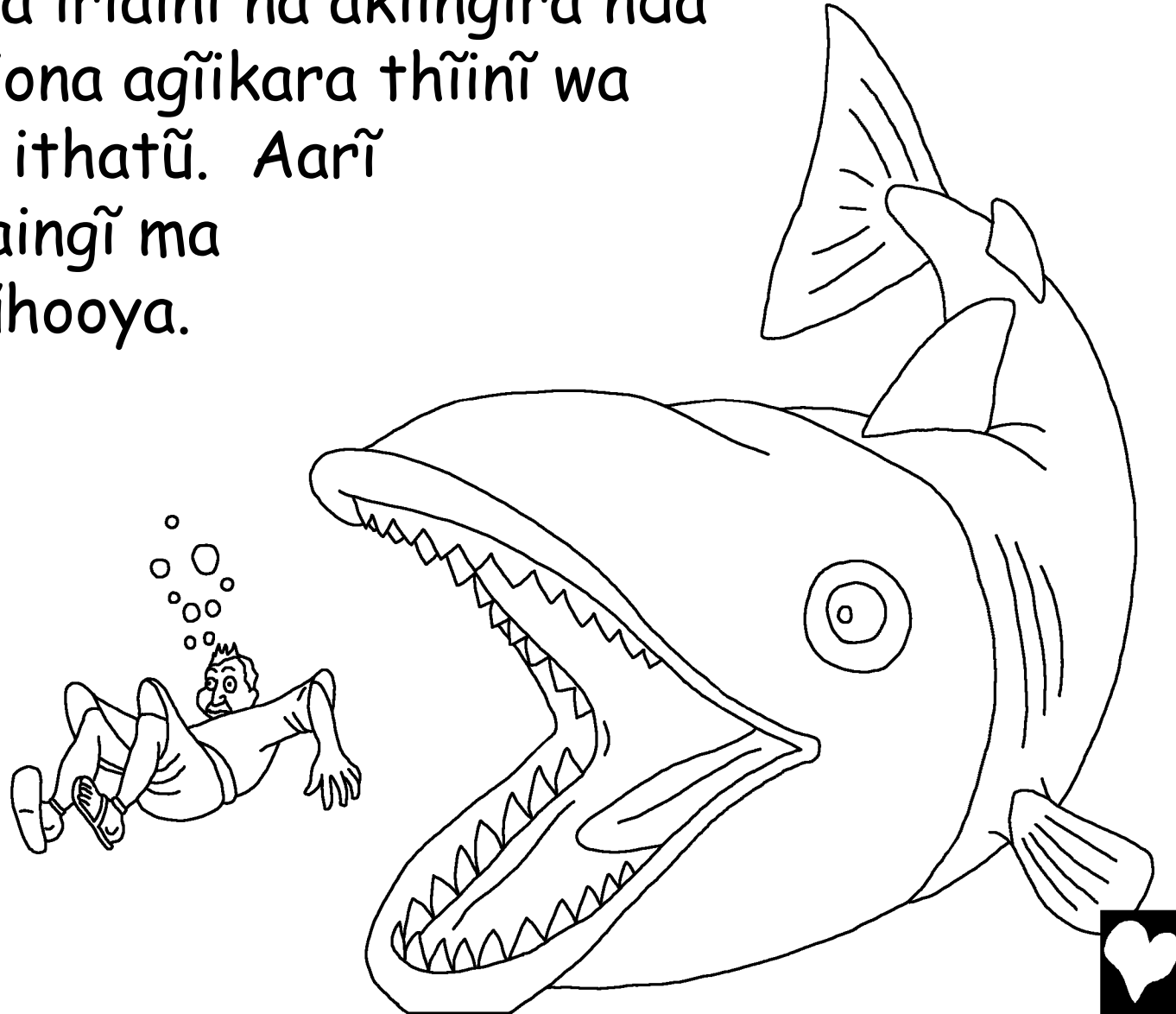

Thuutha wa thikū ithatū, Jona akīrīra Ngai
kūmūathīkīra. O rīmwe Ngai akīarīria thamaki, na
īkīmūtahīka thī nyūmū.

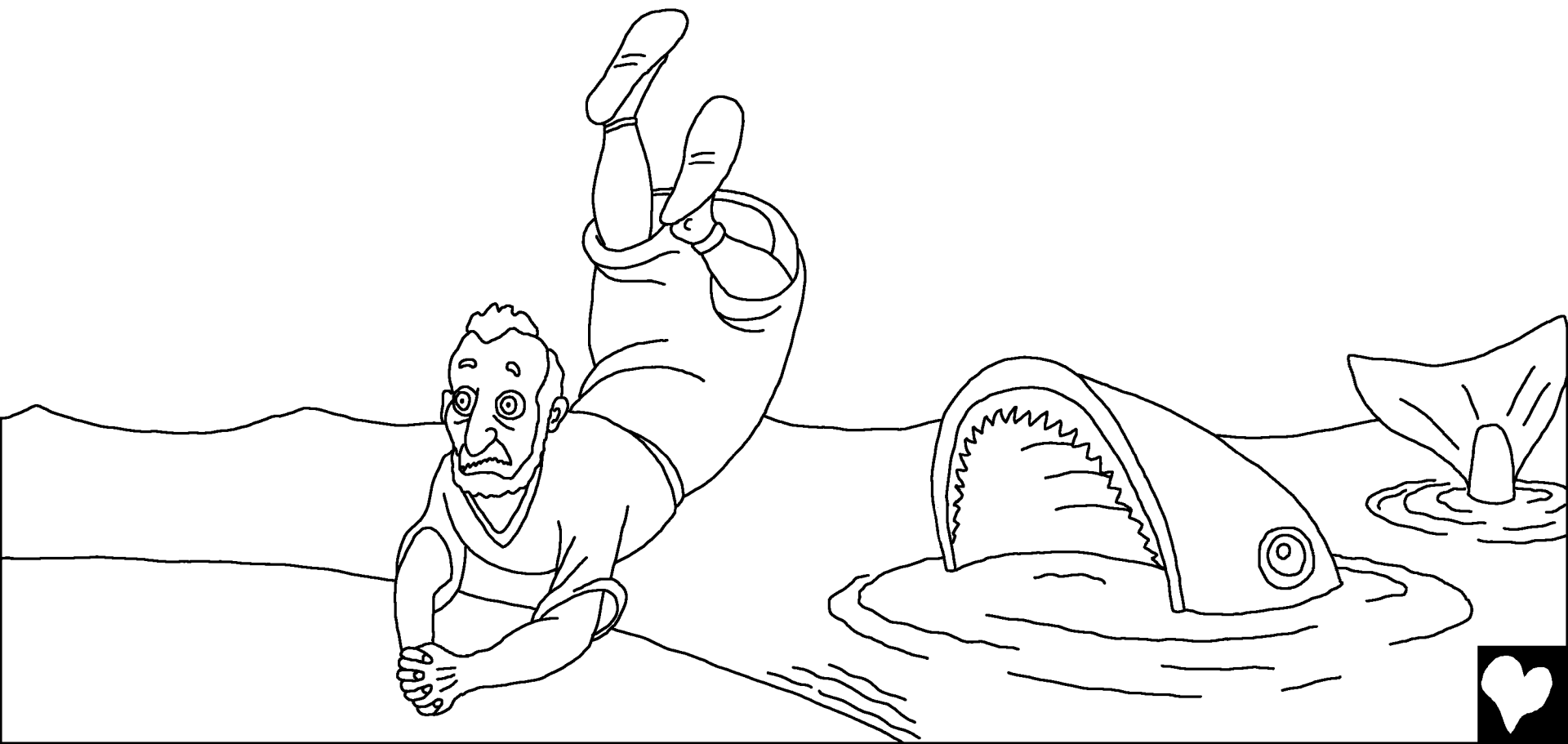

O rīngī Ngai akīira Jona athī Nineve akahunjie kiugo kīa Ngai. Ihinda rīrī Jona agīthī! Jona akīingīra itūūra, akīanīrīra, "Thuutha wa thikū mīrongo ĩna Nineve nīkūharaganio."



Andũ a Nineve magĩĩtĩkia kiugo kĩa Ngai.
Magĩikara matakũrĩa, magĩĩkĩra makũnia kuonia
Ngai atĩ nĩmahereete nĩũndũ wa meehia maa. O na
mũthamaki akĩĩnyihia mbere ya Ngai. Akiuma gĩtĩinĩ
gĩake kĩa ũnene, agĩĩkĩra makũnia na agĩĩkarĩra mũhu.
Agĩatha andũ othe matigane
na njĩra ciao cia waganu
na haaro, na mahooe
Ngai amoohere.

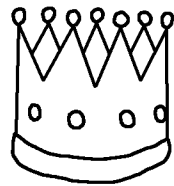

Ngai NAMA akĩmoohera! No nginya gũkorwo waarĩ
mũthenya wa magegania wa gĩkeno kũu Nineve rĩrĩa
andũ mamenyire atĩ Ngai

nĩamoheire.
... no mũndũ
ũmwe
nĩarakarire
mũno. Jona!



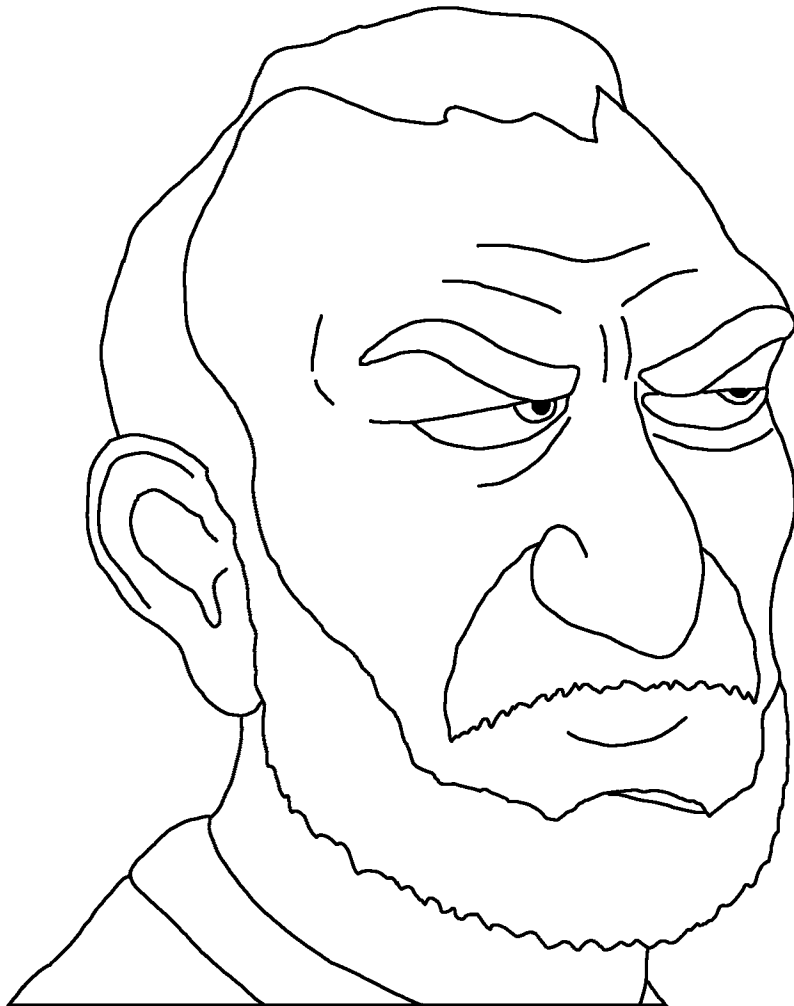

Jona arakaririo
nĩ kĩĩ? Akĩĩra Ngai,
“Nĩngũmenyaga atĩ we wĩ
Ngai wa ũtugi, na mũigua
tha, ndũhiũhaga kũraakara
na ũiyũire wega.” Nĩ kuuga
atĩ Jona nĩoĩ atĩ Ngai
nĩohagĩra arĩa meerira
meehia mao hingo ciothe
na gwathĩkĩra kiugo kĩa
Ngai. Nĩkũrooneka atĩ
Jona ndeendete andũ a
Nineve. Ndeendaga
moherwo.



Jona arakarĩtio mũno nĩ Ngai akiuga, "Oya muoyo wakwa; nĩgũkorwo gĩkuũ nĩ kĩega kũrĩ nĩ gũkĩra muoyo."



Jona agĩkara nja ya itũũra, oone ũrĩa Ngai agocooka eeke. Mwathani Ngai akĩharĩria mĩtĩ waarĩ na mathangũ manene. Ũgĩkũra naihenya, na ũkĩhe Jona kĩruru kumana na riũa inene mũthenya wothe.



Rūciinĩ rūu rūngĩ, Ngai agĩtũma kĩgunyũ, gĩkĩũraga
mũtĩ ũcio. Mwathani agĩcooka akĩharĩria rūhuuho
rwarĩ rūhiũ na rūnene rūkĩgũtha Jona nginya agĩĩciria
nĩagũkua. Maũndũ maya mothe magĩtũma Jona
arakare makĩria.



Mwathani akĩira Jona, "Ūrĩ na kĩhooto
kĩrĩkũ kũraakara? Nĩũigwĩire mĩtĩ ũyũ
tha, onagũkorwo hatirĩ wĩira ũrutĩite
na ndũnatũma ũkũre. Ūrakũrĩre
ũtukũ na wakua ũtukũ.

Ngwaga kũigwĩira

Nineve tha
nĩkĩ, itũũra rĩu
inene, hamwe
na makiri ma
andũ a rĩo?

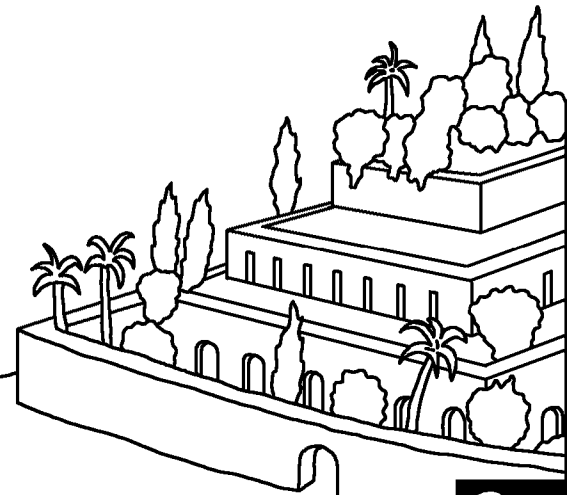
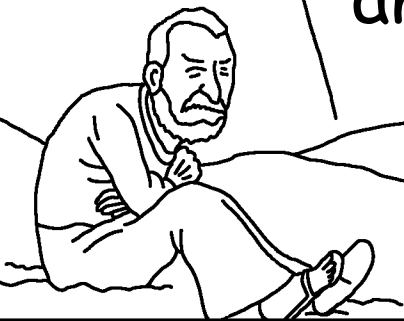

Jona na Thamaki Nene

Rũgano kuma Kiugoinĩ kĩa Ngai,
kĩrĩa kĩ Ibukuinĩ rĩa Ngai,

rũrĩ thĩinĩ wa

Jona

"Ciugo Ciaku ciatarĩrio nĩrehaga ũtheri."
Thaburi 119:130





Mãico

26

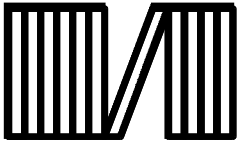

60



Rũgano rŭrũ, rŭrĩa rumĩte Ibukuinĩ rĩa Ngai,
rŭratũmenyithia igŭrũ rĩa Ngai witũ wa magegania,
arĩwe ũrĩa watũmbire na ningĩ akenda ũmũmenye.

Ngai nĩoĩ atĩ nĩtwĩkĩte maũndũ moru, marĩa etaga mehia.
Mũcara wa mehia nĩ gĩkuũ, no Ngai nĩakwendete mũno makĩria
nginya agĩtũma Mŭrũ wake wa mũmwe, Jesũ, nĩguo oragwo
mũtharabainĩ na aherithio nĩtondũ wa mehia maku. Nĩacokire
akĩriũka na akĩinũka mũciĩ igŭrũ kwa Ngai! Ũngĩtĩkia Jesũ na ũmũrie
akuohere mehia maku, nĩegwĩka ũguo! Nĩegũka na atũre thĩinĩ
waku kuma rĩu, na ningĩ ũgatũrania nake tene na tene.

Ũngĩtĩkia atĩ ũhoru ũyũ nĩ wa ma, ĩra Ngai ũũ:
Mwendwa Jesũ, nĩndetĩkia atĩ wĩ Ngai, na nĩwatuĩkire
mũndũ nĩguo ũkue nĩtondũ wa mehia makwa, na rĩu wĩ muoyo.
Nĩndakũhoya ũũke mũtũrĩreinĩ wakwa na ũnjohere mehia makwa,
nĩguo kuma rĩu, ngĩe na muoyo mwerũ, na mũthenya ũmwe ngoka
ndũranie nawe tene na tene. Ndeithia gũgwathĩkagĩra na
gũgũtũrĩra ta mwana waku. Nĩgũtuĩke ũguo.

Thoma Ibuku rĩa Ngai na waranagĩrie nake o
mũthenya o mũthenya! Johana 3:16

