

Ibuku rĩa Ngai kũrĩ ciana
nĩrĩrakũrehera

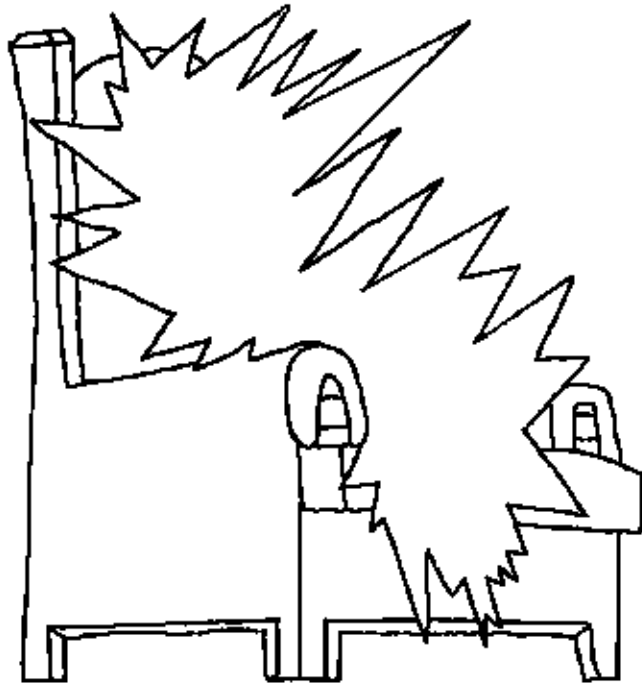

Igũrũ, mũcĩĩ
mũthaka wa
Ngai



Rwandĩkĩtwo nĩ: Edward Hughes
Rũthathaũrĩtwo nĩ: Lazarus
Rũharĩrĩrio nĩ: Sarah S.
Rũtaũrĩtwo nĩ: Christian Lingua
Rũtungĩtwo nĩ: Bible for Children
www.M1914.org

BFC
PO Box 3
Winnipeg, MB R3C 2G1
Canada

©2018 Bible for Children, Inc.
Rũtha: Nĩwĩtĩkĩrĩtio kuruta kana gucabithia rũgano rũrũ,
angĩkorwo ti rwa kwendia.



Rĩrĩa Jesũ aatũraga thĩ, nĩerire arutwo ake ũhoro
wĩgĩĩ igũrũ. Agĩgwĩta "nyũmba ya Baba", na akĩmera
atĩ kũu kwĩ nyũmba nyingĩ, nene
na thaka mũno. Igũrũ nĩ
gũthaka mũno makĩria,
gũkĩra gũkũ
tũtũraga thĩĩno.



Jesũ akiuga, "Nĩngũthĩĩ kũmũharĩĩria gĩikaro. Na ndamũthondekera gĩikaro kĩu, nĩngacooka ndĩmũnyite ũgeni kuo." Jesũ nĩambatire igũrũ thutha wa kũriũka kuma kũrĩ akuũ. Ambatirio arutwo ake mamwĩroreire, itu rĩkĩmwamũkĩra, makĩremwo nĩkũmuona rĩngĩ.

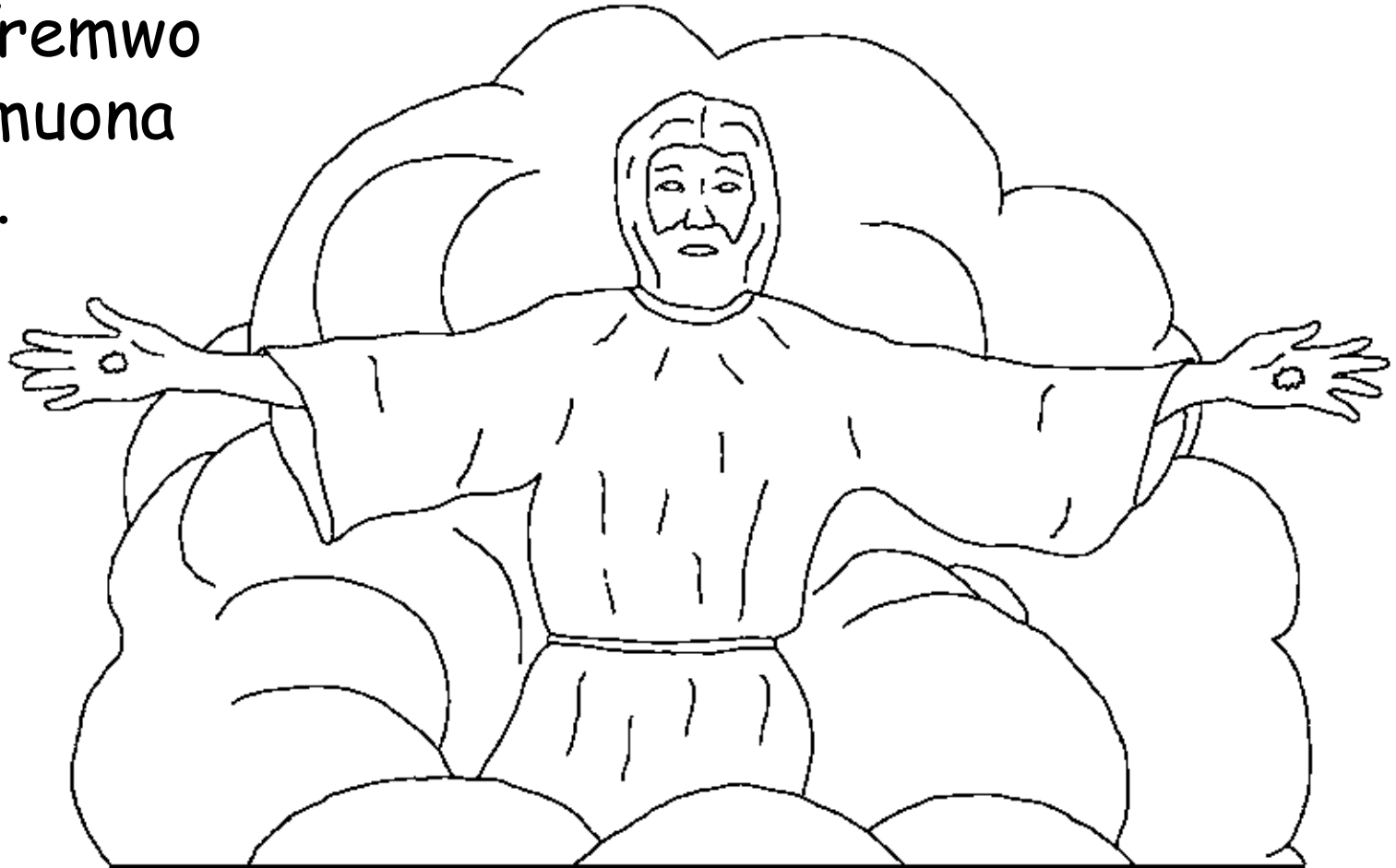

Kuma hĩndĩ ĩyo, arũmĩrĩri a Kristũ nĩmaririkanaga
kĩrĩkanĩro kĩa Jesũ gĩa gũkanacooka kũmagĩra. Jesũ
oigire nĩagacoka rĩrĩa aterĩgĩrĩirwo.

Gũkahuanĩka atĩa hiihi kũrĩ arĩa
magakorwo makuĩte atocokete?

Ibuku rĩa Ngai riugaga atĩ
magathĩĩ rĩmwe kwa rĩmwe

gũtũranie na Jesũ.

Gũkorwo mũndũ atarĩ
thĩinĩĩ wa mwĩrĩ,

**HAMWE NA
MWATHANI**

nĩgũkorwo e hamwe
na Mwathani.



Kūguūrīrio, arīrīo ibuku rīa mūico thīinī wa Ibuku
rīa Ngai, rītwīraga ūrīa igūrū gwī kwa magegania.

Ūndū ūrīa wa kūgegania mūno makīria nī atī, na njīra
ya mwanya, igūrū nīkuo
mūciī kwa Ngai. Ngai
arī kūdū guothe,
no gītī gīake
kīa ūthamaki
kīrī igūrū.

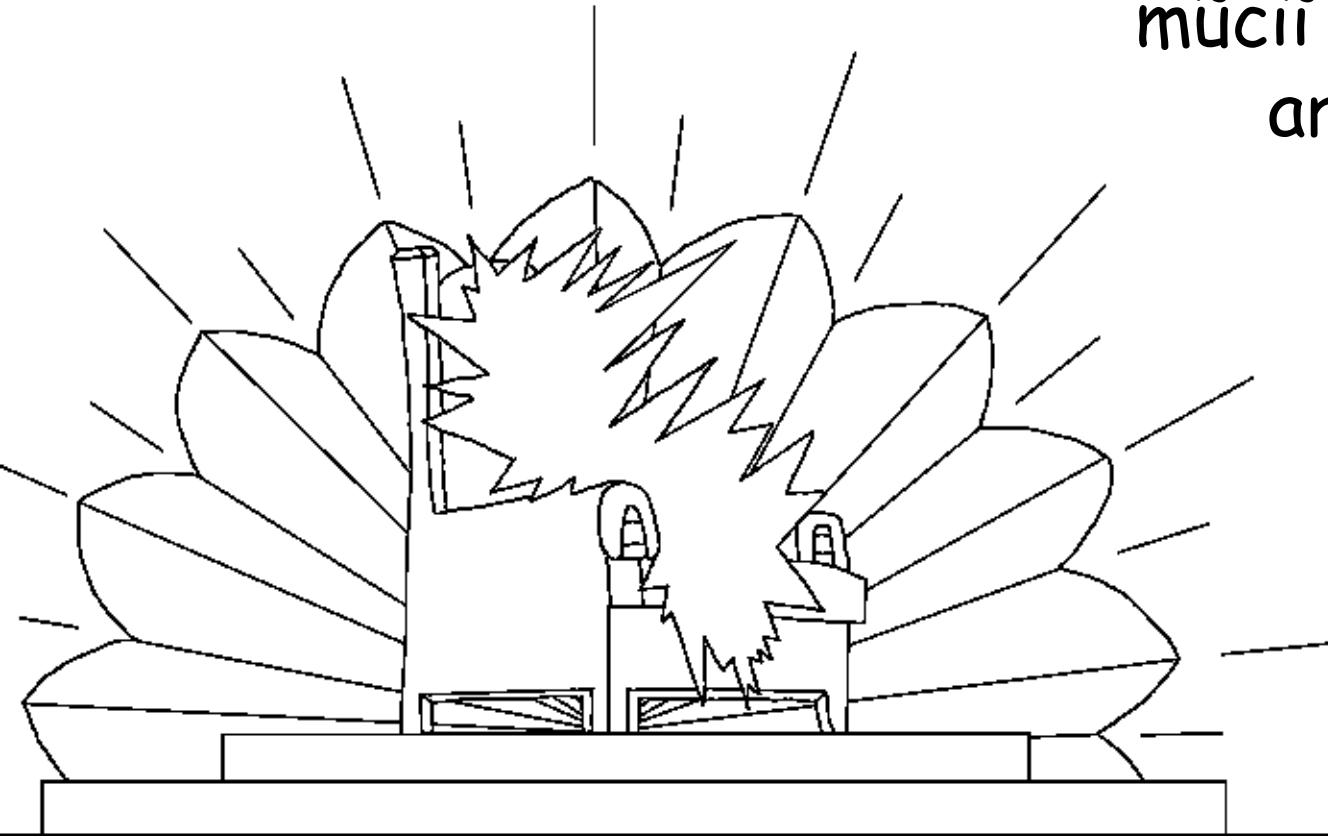

Araika o hamwe na ciũmbe ingĩ cirĩ
muoyo matũraga mathathayagia
Ngai kũu igũrũ. O ũguo noguo
andũ a Ngai othe arĩa marĩkĩtie
gũkua na magathĩ igũrũ mekaga.
Mainagĩra Ngai nyĩmbo cia
mwanja cia
kũmũgoca.



Ici nĩ ciugo imwe cia rwĩmbo rũmwe rũrĩa mainaga:
WE NĨWAGĨRĨIRE NĨTONDŪ NĨŪTŪKŪRĨITE
ŪGATŪHEANA KŪRĨ NGAI NA
NJĨRA YA THAKAME YAKU,
KUMA NDŪRĨRĨ CIOTHE
NA MABŪRŪRI MOTHE NA
ŪGATŪTUA ATHAMAKI NA
ATHĨNJĨRI
A NGAI
WITŪ.
(Kũguũrĩrio
5:9)



Ibuku rĩa Ngai rĩkĩrĩkĩrĩria, rĩtarĩirie igũrĩ
ta "Jerusalemu Njerũ". Nĩ itũra inene mũno
rĩthiũrũrũkĩirio nĩ rũthingo rũnene. Rũthingo rũu nĩ
rwa mahiga metagwo jasiperi na rũhuana ta gĩcicio
gĩtheru biũ.

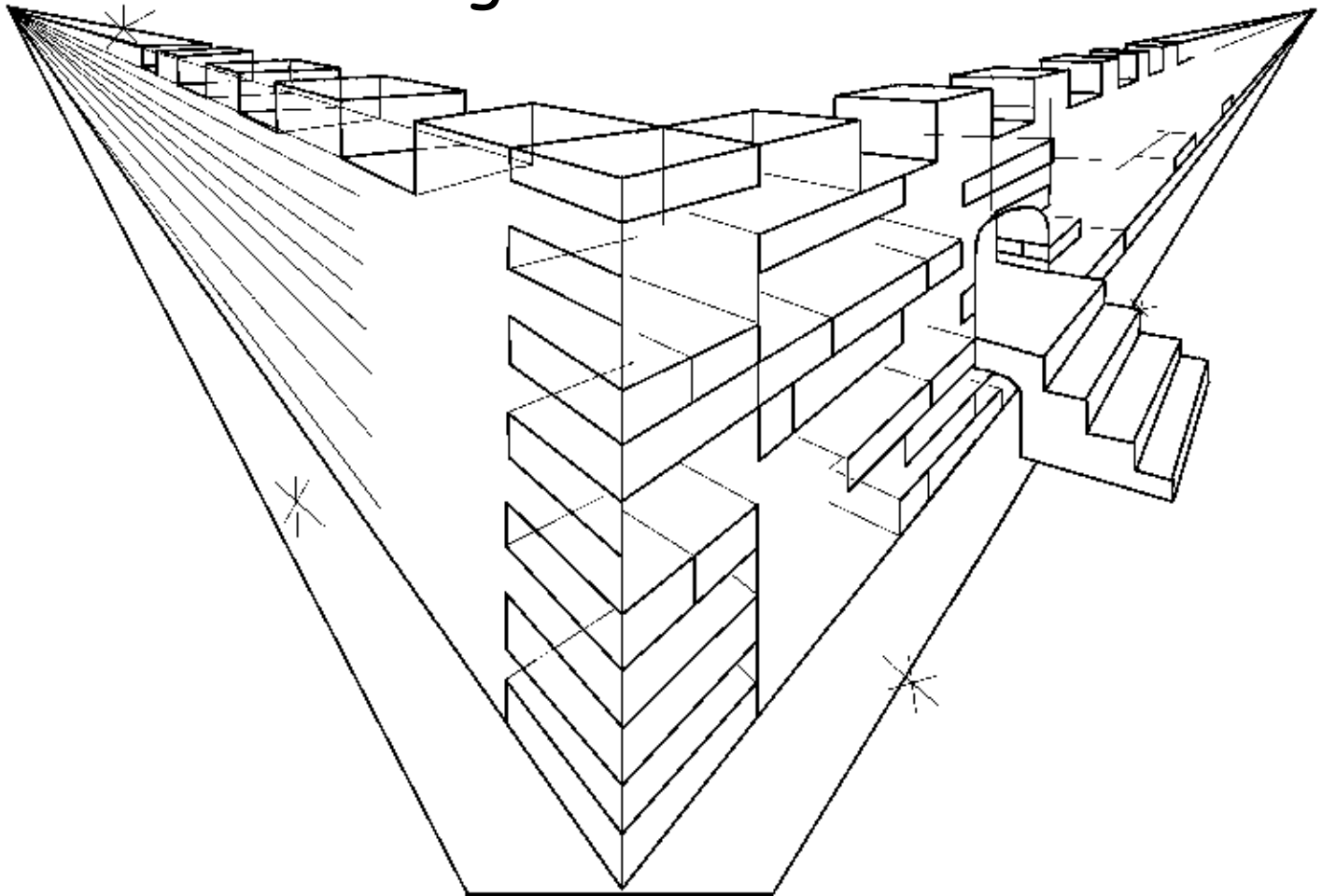

Mũthingi wa rũthingo rũu wagemetio na mahiga ma goro mũno mahenahenagia marĩ ma marangi mathaka mũno. O kĩingĩrĩro kĩa itũra rũu gĩathondeketwo kuuma kwĩ ihiga inene biũ rĩa ruuru!

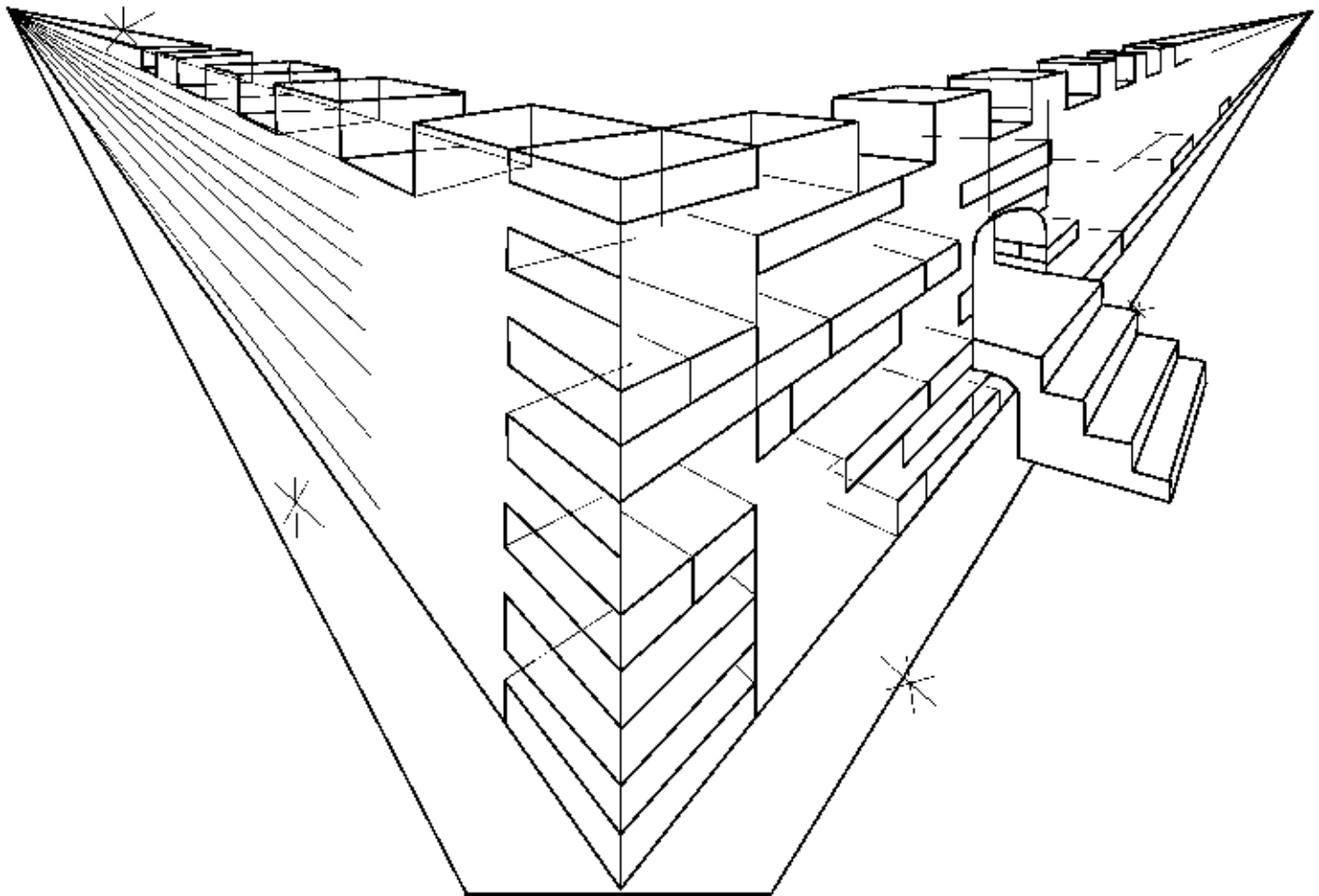

Cingĩrĩro icio cia ruuru citihingagwo. Reke
tũingĩre kuo twĩyonere ... HAIYA! Igũrũ nĩ gũthaka
mũno thĩiniĩ ona gũkĩra nanja. Itũra rĩu rĩakĩtwo na
thahabu ĩrĩa theru biũ ĩrĩa ĩhuana ta gĩcicio gĩtheru.
Ona njĩra yarĩo
yakĩitwo na
thahabu.

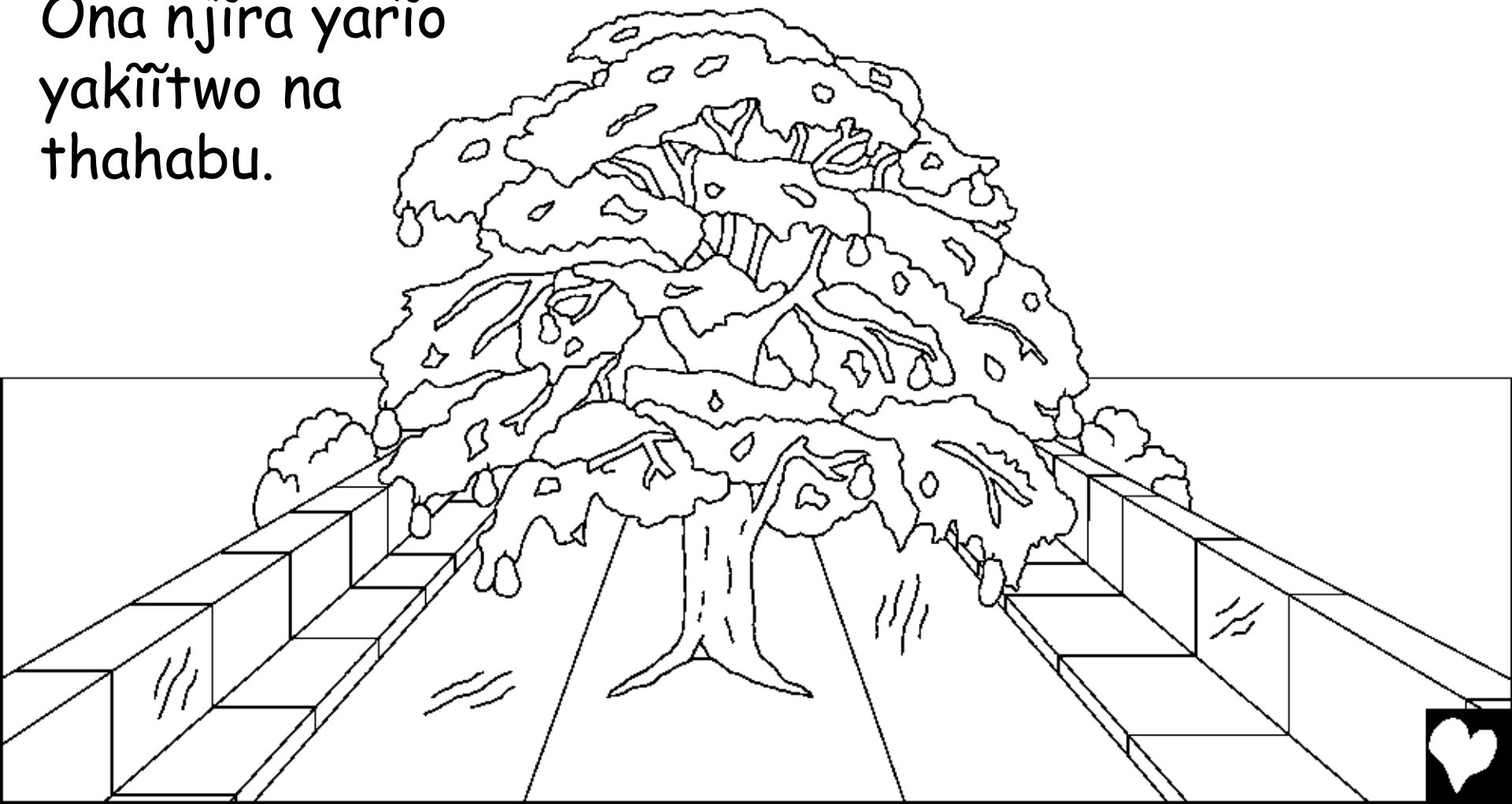

Rũũĩ rũthaka na rũtheru mũno rwa maĩ ma muoyo
rũthereraga kuma gĩtĩnĩ kĩa ũthamaki kĩa Ngai.
Na mũena yothe ĩĩrĩ ya rũũĩ rũu hena mũtĩ wa muoyo,
ũrĩa twaiguire ũhoru waguo mũgũndainĩ wa Edeni.
Mũtĩ ũyũ nĩwa mwanya mũno. Ūciaraga matunda
ma mũthembe ikũmi na ĩĩrĩ, o mũthemba mwanya,
mweri o mweri. Na mahuti ma mũtĩ ũcio wa muoyo
nĩmakũhonia mabũrũri.

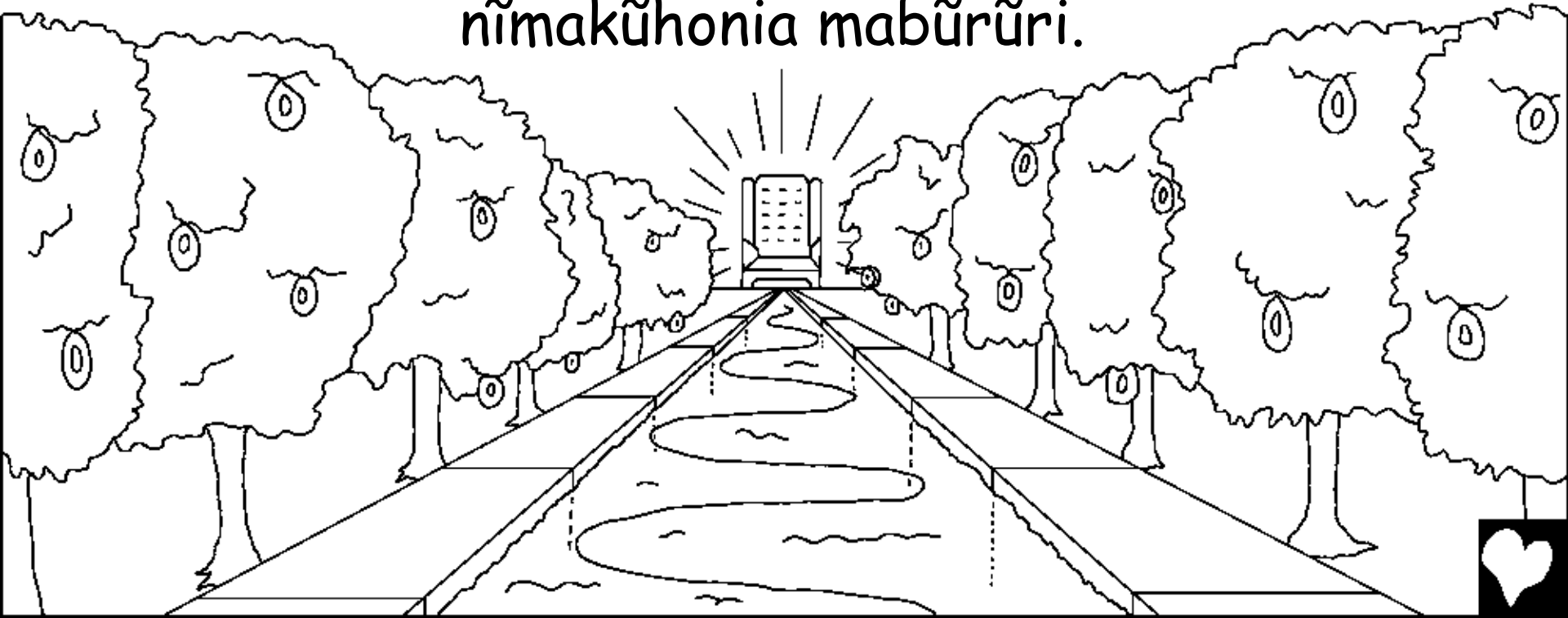

Igũrũ gũtibataranagia ũtheri wa riũa kana mweri.
Riiri wa Ngai we mwene ũiyũragia itũra rĩu na ũtheri
wa magegania. Kũu gũtitukaga.

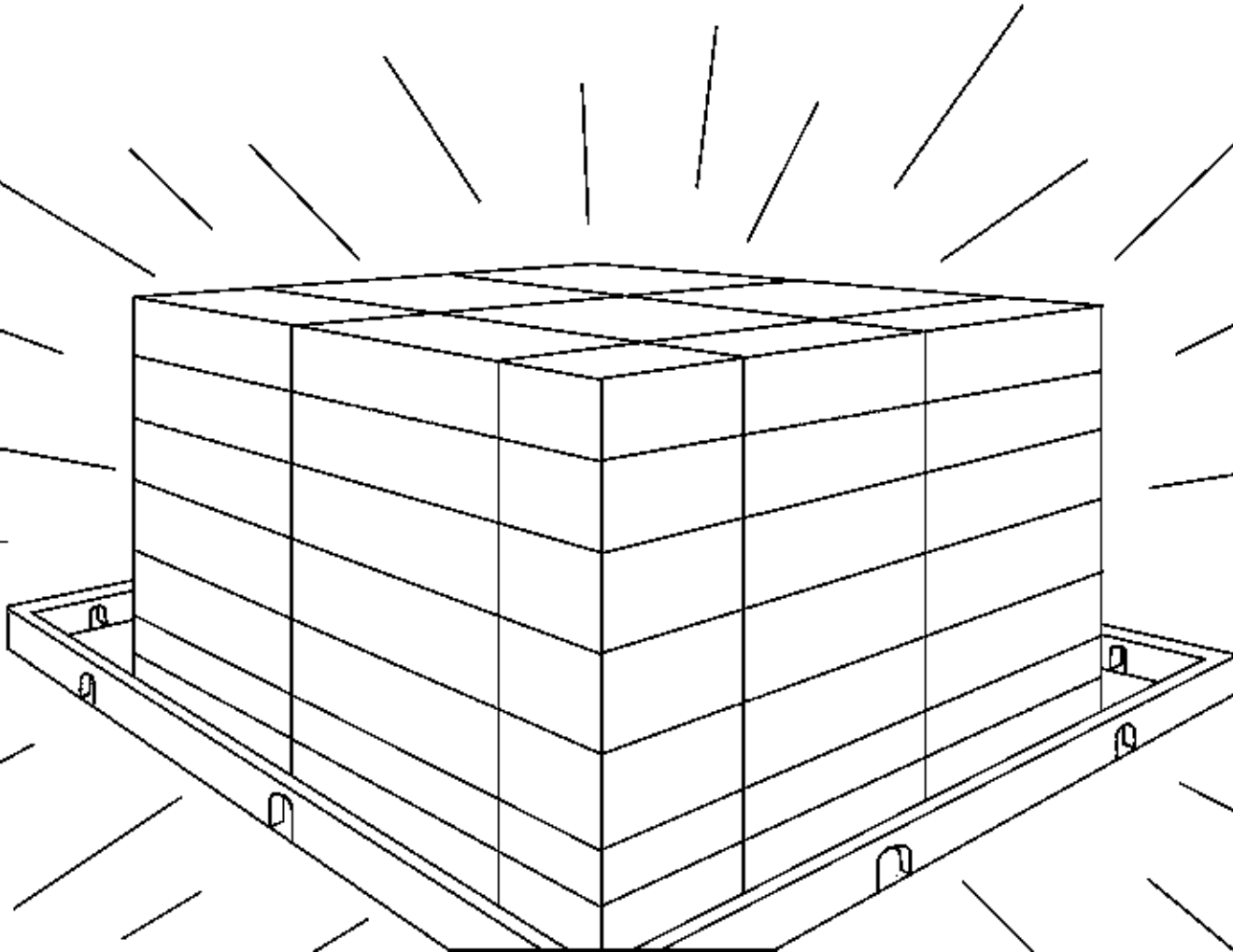

Ona nyamũ iria irĩ kũu igũrũ nĩ cia mwanja. Ciothe nĩ horeri na nĩciendanĩte. Mĩthige na tũgondũ irĩaga nyeki cĩĩ hamwe. Ona mĩrũthi ĩrĩa mĩnene ĩrĩaga nyeki ta ng'ombe. Mwathani oigĩte, "Itigatihania kana ciũragane kĩrĩmainĩ gĩakwa kĩrĩa gĩtheru."

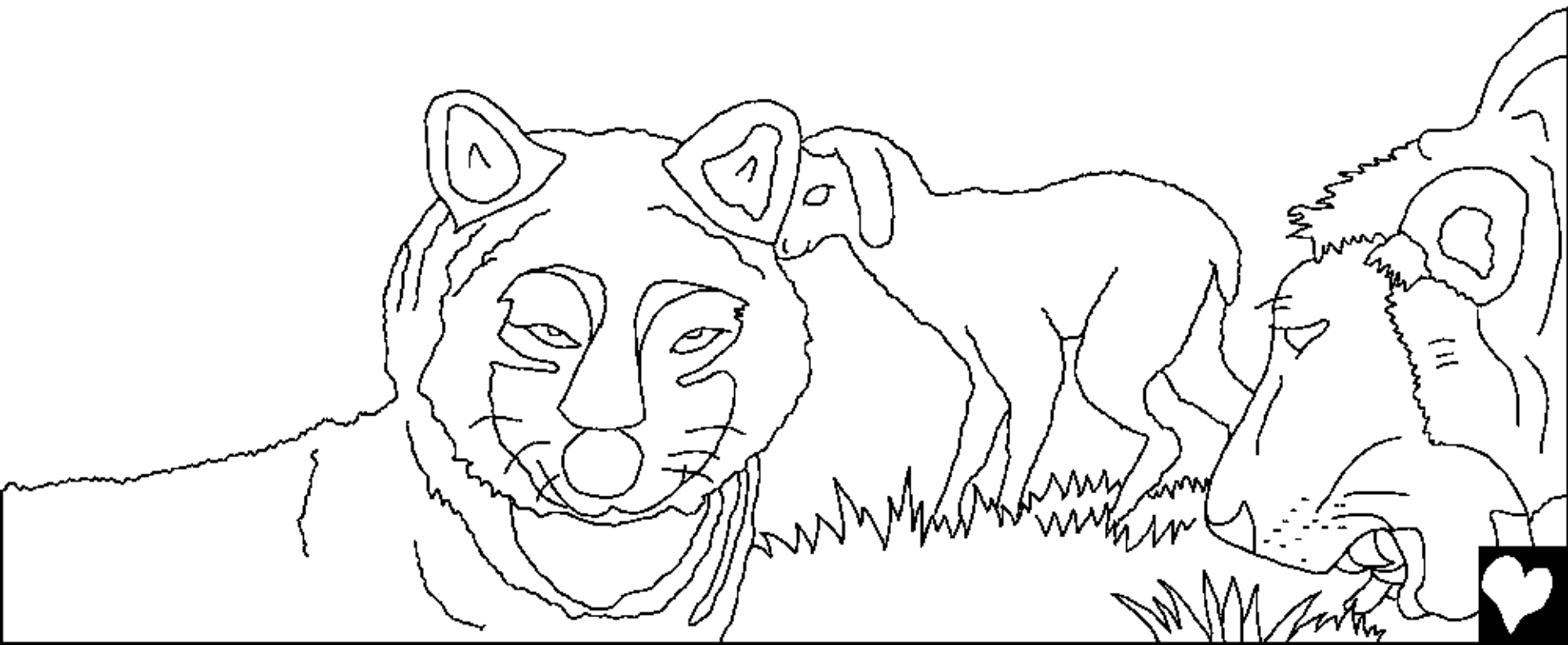

O tũgĩthĩĩ na mbere
kwĩrorera, kwĩ na indo
tũtarona kũu igũrũ.

Gũtirĩ ciugo cia
marakara
ciiguĩkanaga
kuo. Gũtirĩ
mũndũ
ũraharana
kana
akeenda.
Gũtirĩ
makuburi
mĩrangoinĩ,



nĩtondũ igũrũ gũtirĩ aici.
Ningĩ gũtirĩ andũ arĩa
maragia maheni,
oragani, arogi,
kana eki naĩ a
mũthemba
ũngĩ o
wothe.
Gũtirĩ
wĩhia o
wothe
kũu igũrũ.



Kūu igūrū kwa Ngai gūtirī
kūrīra rīngī. Rīmwe andũ a
Ngai nīmarīraga nītondũ wa
kīeha kīingī kīrīa menakĩo
mūtūrīreinĩ ũyũ. Makinya
igūrū, Ngai nīakamagiria
maithori mothe.



Ningĩ igũrũ gũtirĩ gĩkuo. Andũ a Ngai magatũũra na Mwathani tene na tene. Gũtirĩ kĩaha, gũtirĩ kũrĩra ona kana kuigua ruo rĩngĩ. Gũtirĩ mĩrimũ, gũtirĩ gũtigana, ona kana mathiko. O mũndũ o wothe kũu igũrũ nĩmũkenu hĩndĩ ciothe, nĩtondũ wagũtũrania na Ngai.



Igūrũ rĩa mothe, igūrũ nĩ gwa tũhĩĩ na tũirĩtu (ona ningĩ andũ agima) tũrĩa twĩtĩkĩtie Jesũ Kristũ ta Mũhonokia watuo na tũkamwathĩkĩra ta Mwathani watuo. Kũu igūrũ nĩkũrĩ ibuku rĩtagwo ibuku rĩa Gatũrũme rĩa Muoyo. Rĩiyũrĩte marĩtwa ma andũ. Nĩũĩ marĩtwa ma andũ arĩa mandĩkĩtwo ibukuinĩ rĩu? Andũ arĩa othe mehokete Jesũ. Rĩtwa rĩaku rĩho?



Ciugo cia mũico cia Ibuku rĩa Ngai iria ciarĩtie
ũhoro wa igũrũ, nĩ cia kũnyita andũ ũgeni na njĩra
nene. "Nake Roho na mũhiki marauga, 'ũka!' Reke
ũrĩa ũkũigua oige, 'ũka!' Reke ũrĩa mũnyotu ooke.
Na ũrĩa wothe ũkwĩrirĩria, reke atahie maĩ ma muoyo

hatarĩ
marĩhi."



Igũrũ, mũciĩ mũthaka wa Ngai

Rũgano kuma Kiugoinĩ kĩa Ngai,
kĩrĩa kĩ Ibukuinĩ rĩa Ngai,

rũrĩ thĩinĩ wa

Johana 14; Akorintho wa Kerĩ 5;
Kũguũrĩrio 4, 21, 22

"Ciugo Ciaku ciatarĩrio nĩrehaga ũtheri."
Thaburi 119:130



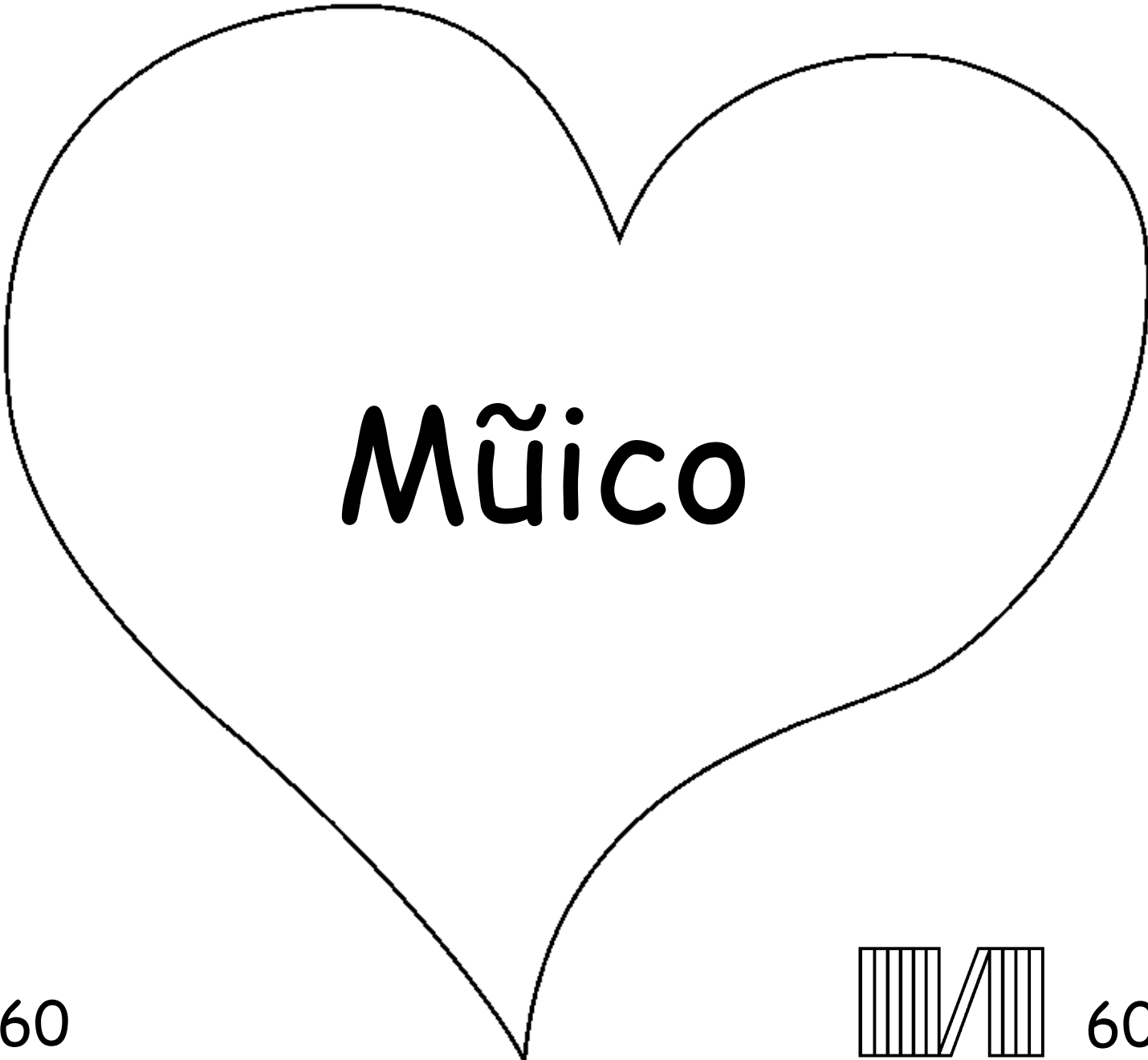

Mãico

60

60



Rũgano rŭrũ, rŭrĩa rumĩte Ibukuinĩ rĩa Ngai,
rŭratũmenyithia igŭrũ rĩa Ngai witũ wa magegania,
arĩwe ũrĩa watũmbire na ningĩ akenda ũmũmenye.

Ngai nĩoĩ atĩ nĩtwĩkĩte maũndũ moru, marĩa etaga mehia.
Mũcara wa mehia nĩ gĩkuũ, no Ngai nĩakwendete mũno makĩria
nginya agĩtũma Mŭrũ wake wa mũmwe, Jesũ, nĩguo oragwo
mũtharabainĩ na aherithio nĩtondũ wa mehia maku. Nĩacokire
akĩriũka na akĩinũka mũciĩ igŭrũ kwa Ngai! Ũngĩtĩkia Jesũ na ũmũrie
akuohere mehia maku, nĩegwĩka ũguo! Nĩegũka na atũre thĩinĩ
waku kuma rĩu, na ningĩ ũgatũrania nake tene na tene.

Ũngĩtĩkia atĩ ũhoru ũyũ nĩ wa ma, ĩra Ngai ũũ:
Mwendwa Jesũ, nĩndetĩkia atĩ wĩ Ngai, na nĩwatuĩkire
mũndũ nĩguo ũkue nĩtondũ wa mehia makwa, na rĩu wĩ muoyo.
Nĩndakũhoya ũũke mũtũrĩreinĩ wakwa na ũnjohere mehia makwa,
nĩguo kuma rĩu, ngĩe na muoyo mwerũ, na mũthenya ũmwe ngoka
ndũranie nawe tene na tene. Ndeithia gũgwathĩkagĩra na
gũgũtũrĩra ta mwana waku. Nĩgũtuĩke ũguo.

Thoma Ibuku rĩa Ngai na waranagĩrie nake o
mũthenya o mũthenya! Johana 3:16

