

Bibiliya y' abana  
irerekana

Yona n'ifi  
nini



yanditswe na: Edward Hughes

yashushanyijwe na: Jonathan Hay  
Alastair Paterson

yahujwe na: Mary-Anne S.

yahinduwe na: Margaret Mbabazi

yasohowe na: Bible for Children  
[www.M1914.org](http://www.M1914.org)

©2026 Bible for Children, Inc.

Ufite uruhusa rwo gucapa no gukora kopi y'iyi nkuru  
igihe cyose utagamije kugurisha.



Hashize imyaka myinshi, hari umugabo  
wo muri Isirayeli witwaga Yona.  
Umunsi umwe, Imana yamusabye  
kujya i Nineve, umugi  
munini kandi ukomeye  
kuruta iyindi  
ku isi.

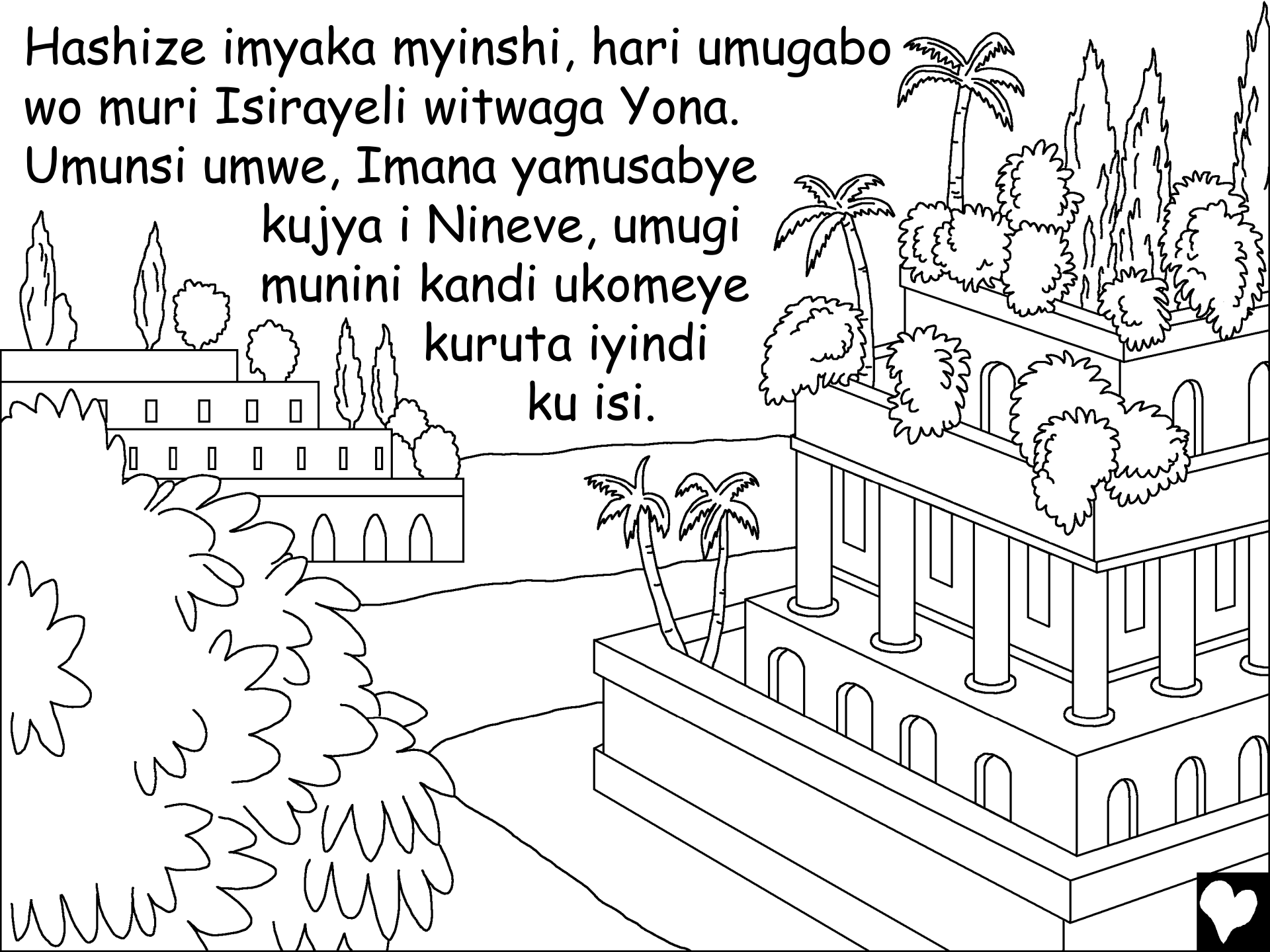

Yona yagombaga kuburira abo bantu  
bose ko Imana yari izi ububi bwabo.

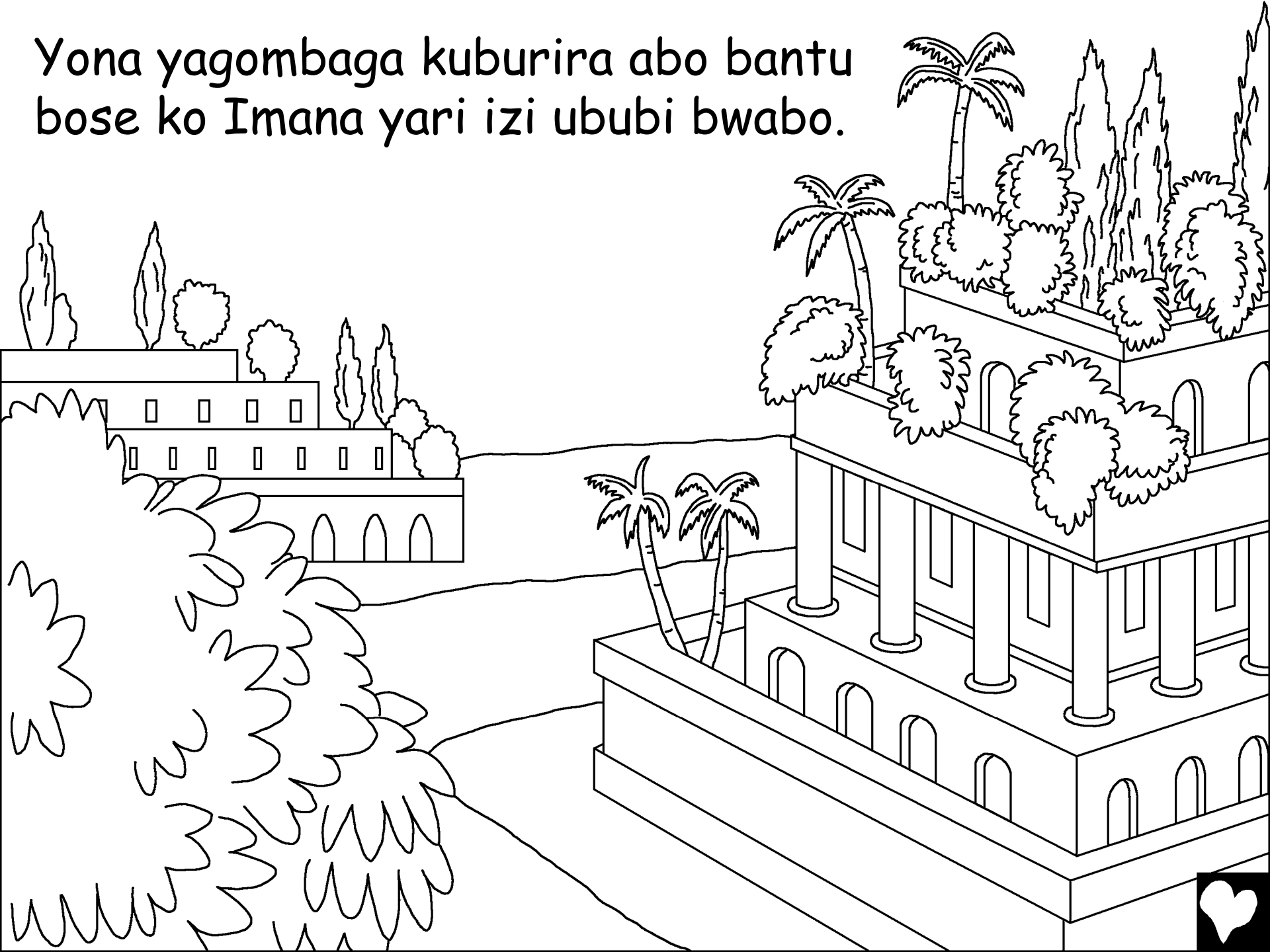

Yona yasuzuguye Imana! Aho  
kugira ngo Yona ajye i Nineve,  
yafashe ubwato bwajyaga i  
Tarushishi.



Nuko Uwiteka yohereza umuyaga mwinshi mu nyanja.  
Hari inkubi y'umuyaga ikaze! Abasare batinyaga ko  
ubwato bushobora guseniyuka bukajya mu mazi.

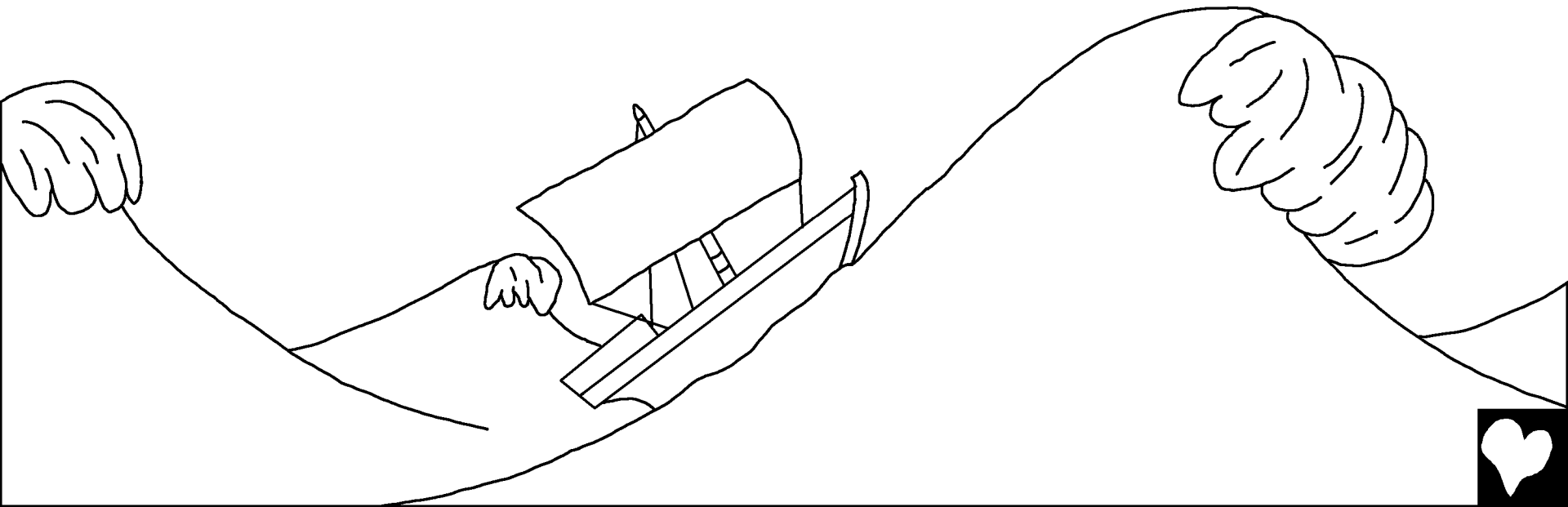

Umuyaga warushijeho kuba mubi. Abasare batewe ubwoba, basenga imana zabo bajugunya imizigo yose kugira ngo boroherenze ubwato. Ariko nta kintu cyafashije.



Yona ni we wenyine wari utarasenga. Ahubwo yari aryamye mu nkuge hasi cyane, aryamye asinziriye cyane. Nuko umutware w'inkuge aza aho ari aramubaza ati "Wabaye ute wa munyabitotsi we? Byuka utakire Imana yawe, ahari Imana yawe yatwibuka ntiturimbuke."

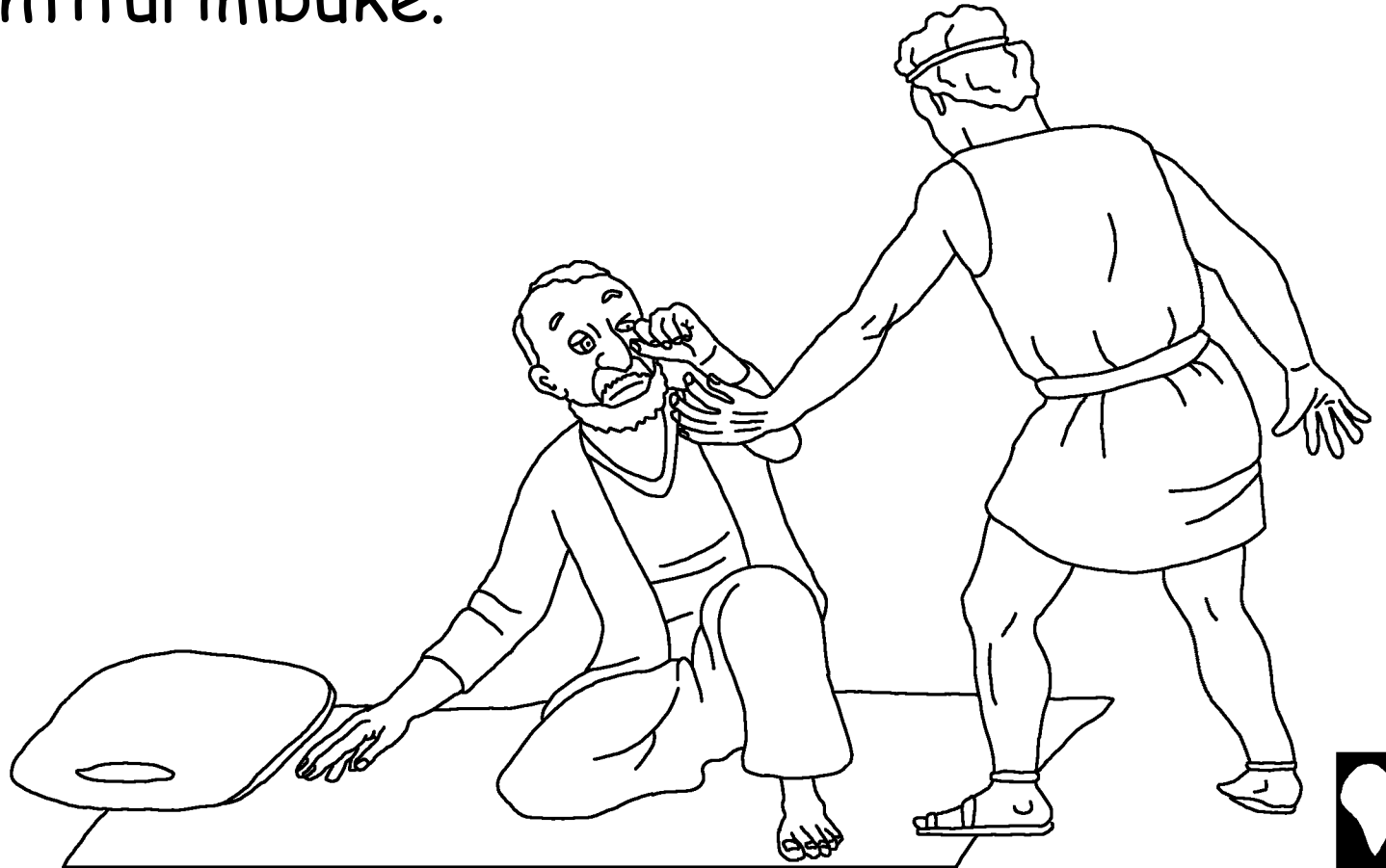



Abasare ntibashatse  
kujugunya Yona mu  
nyanja. Nuko  
bakoresha imbaraga  
zabo zose kugira ngo  
bakure ubwato ku  
nkombe. Ariko  
ntibabishobora.  
Hari ikintu kimwe  
gusa cyo gukora!

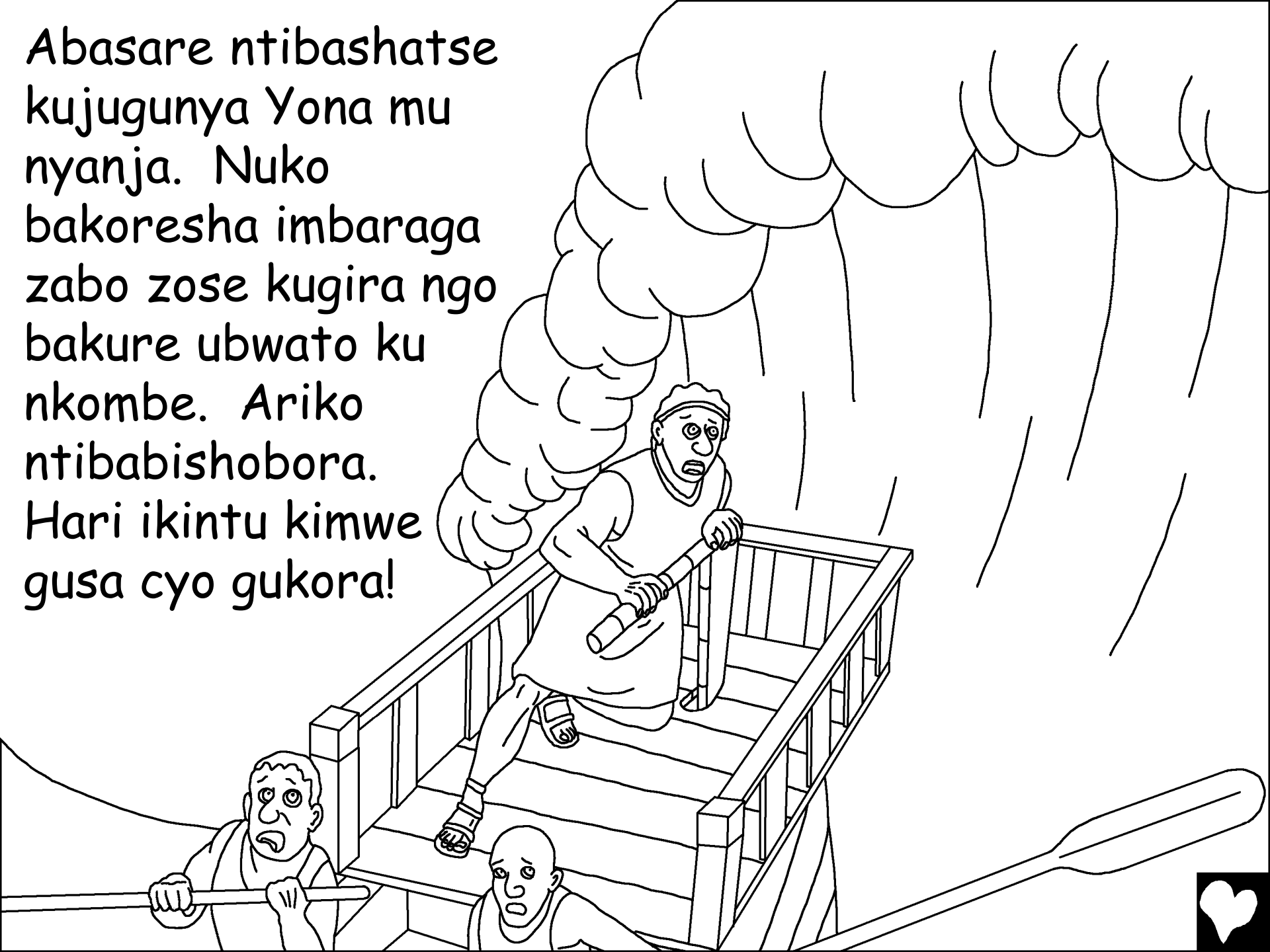

Nyuma yo  
gusenga  
basaba  
imbabazi,  
bazamuye  
Yona  
bamujugunya ku  
kuruhande. Mu gihe  
Yona yari arimo  
arohama mu mazi,  
inyanja yaratuje maze  
umuyaga uratuza.



Ihinduka  
ritunguranye  
ry'ikirere  
ryatumye  
abasare  
bagira ubwoba  
cyane kurusha  
uko bari babitewe n'inkubi  
y'umuyaga. Bagomba kuba  
bari bazi ko Imana yonyine  
ari yo yashoboraga  
kubikora. Batinya  
Imana kandi  
barayihimbaza.



Hagati aho, intumwa  
itumvira yatunguwe  
cyane. Yona yari  
azi ko nta kintu na  
kimwe cyashoboraga  
kumurinda kurohama.  
Na we yashoboraga  
kurohama, ariko  
Imana yari ifite  
izindi gahunda.

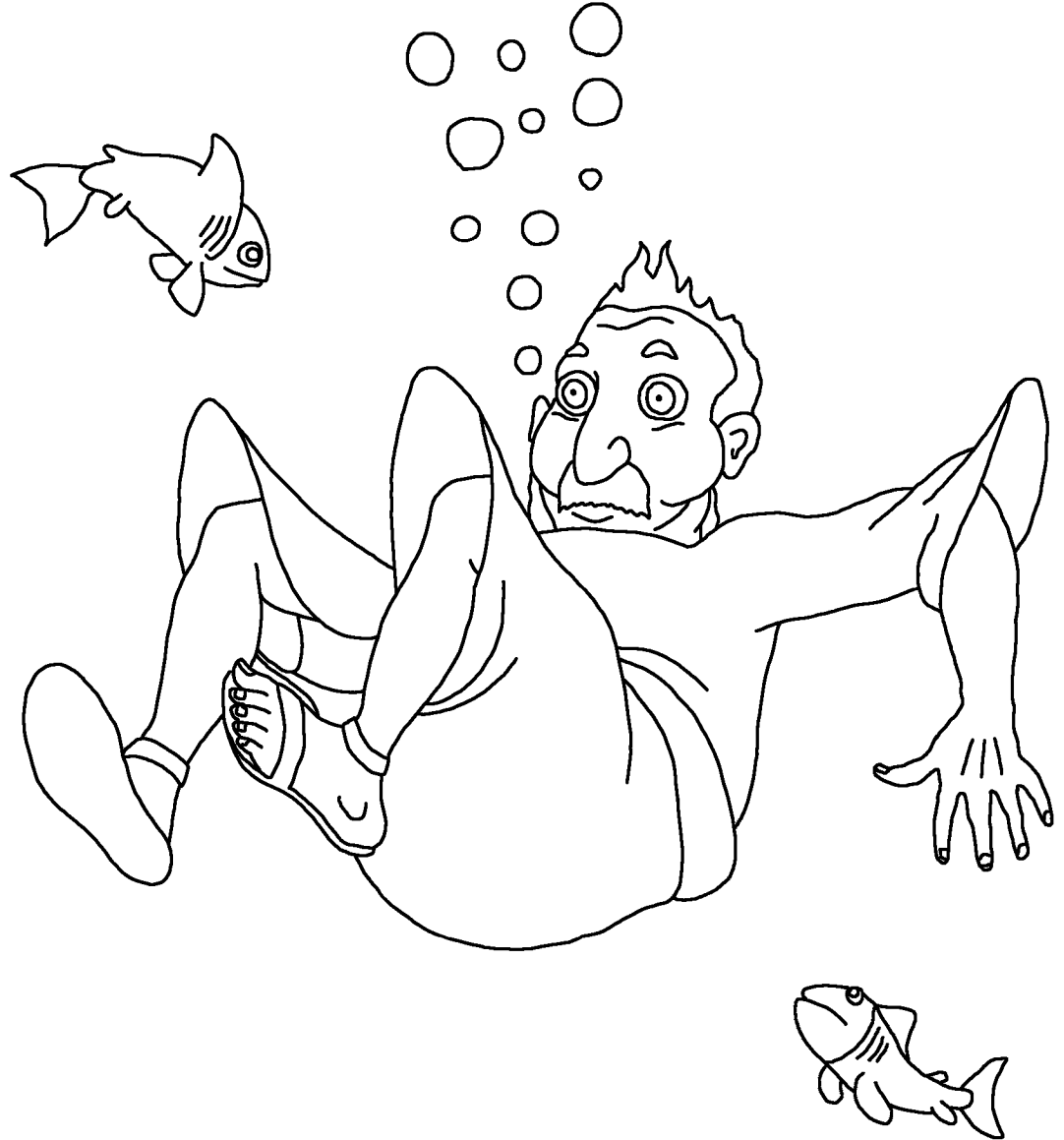

Uwiteka ategeka urufi runini rumira Yona, Iyo fi yaje ku gihe! Urufi rwamize rimwe ava mu nyanja ajya mu nda y'urufi, maze Yona amara mu nda y'urufi iminsi itatu n'amajoro atatu. Yari afite igihe gihagije cyo gutekereza no gusenga.



Nyuma y'iminsi itatu, Yona yasezeranyije kumvira Imana. Imana yahise ibwira iyo fi ngo ijugunye Yona ku nkombe.



Maze ijambo ry'Uwiteka rigera kuri Yona ubwa kabiri riramubwira riti, "Haguruka ujye i Nineve wa murwa munini, uwuburire imiburo nzakubwira." icyo gihe noneho, Yona yaragiye!

Yona yinjira mu mudugudu avuga cyane ati "Hasigaye iminsi mirongo ine, maze Ninivi hakarimbuka".

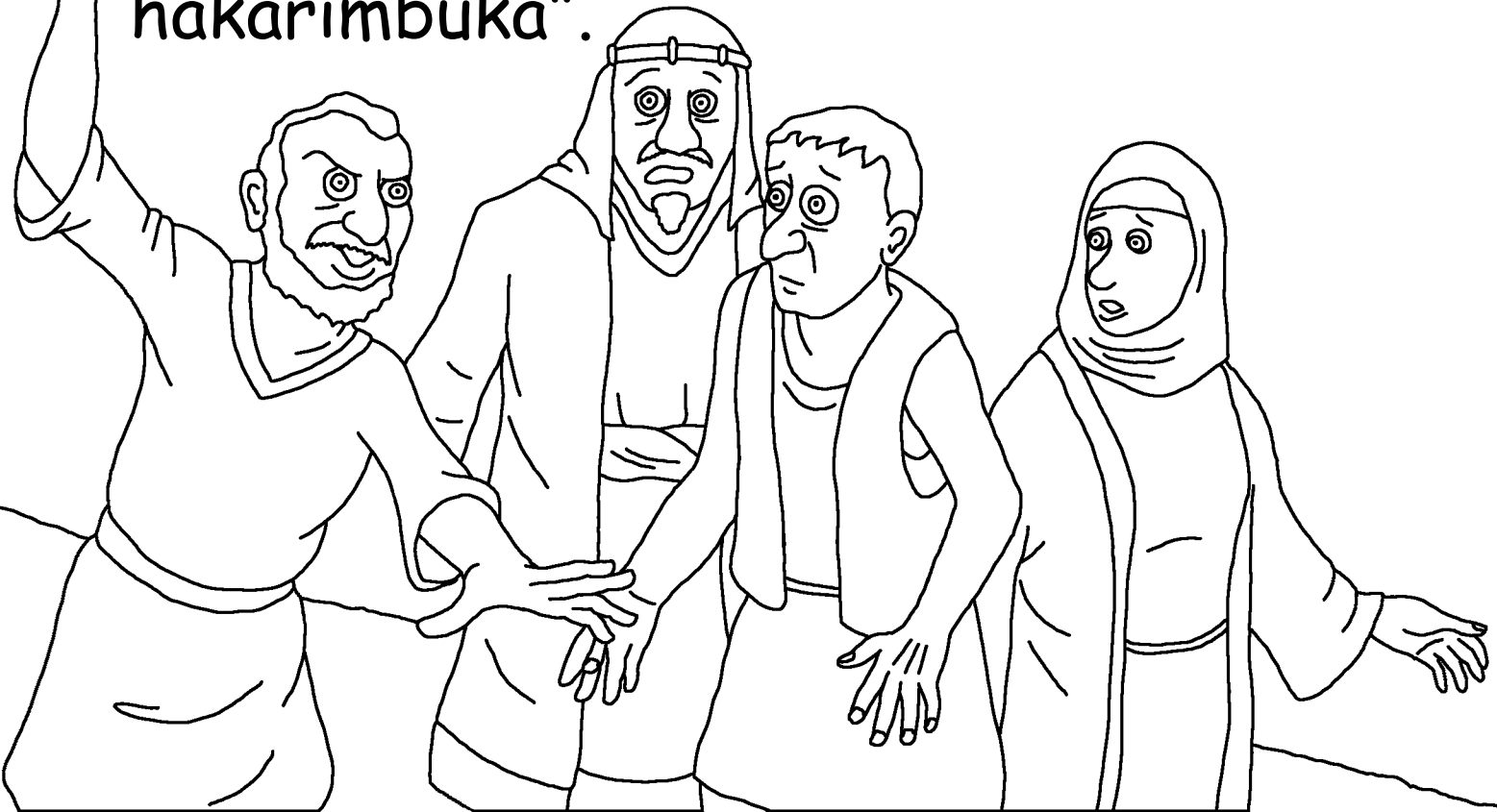

Abantu b'i Nineve bizeye ibyo Imana yari yababwiye. Bahise biyiriza ubusa kandi bambara ibigunira kugira ngo bagaragarize Imana ko bicujije ibyaha byabo. Umwami na we yicishije bugufi imbere y'Imana. Yavuye ku ntebe ye y'ubwami, yambara ibigunira kandi yicara mu ivu. Yategetse abantu bose kureka inzira zabo mbi n'urugomo rwabo, no gusenga basaba ko

Uwiteka yabababarira.

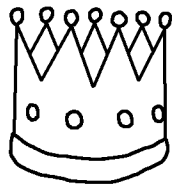

Imana yatubabariye! Bigomba kuba byarabaye  
umunsi mwiza w'ibyishimo i Nineve igihe abantu  
bamenyaga ko Imana  
y'abababariye.  
... Ariko  
umuntu umwe  
yararakaye  
cyane. Yona!



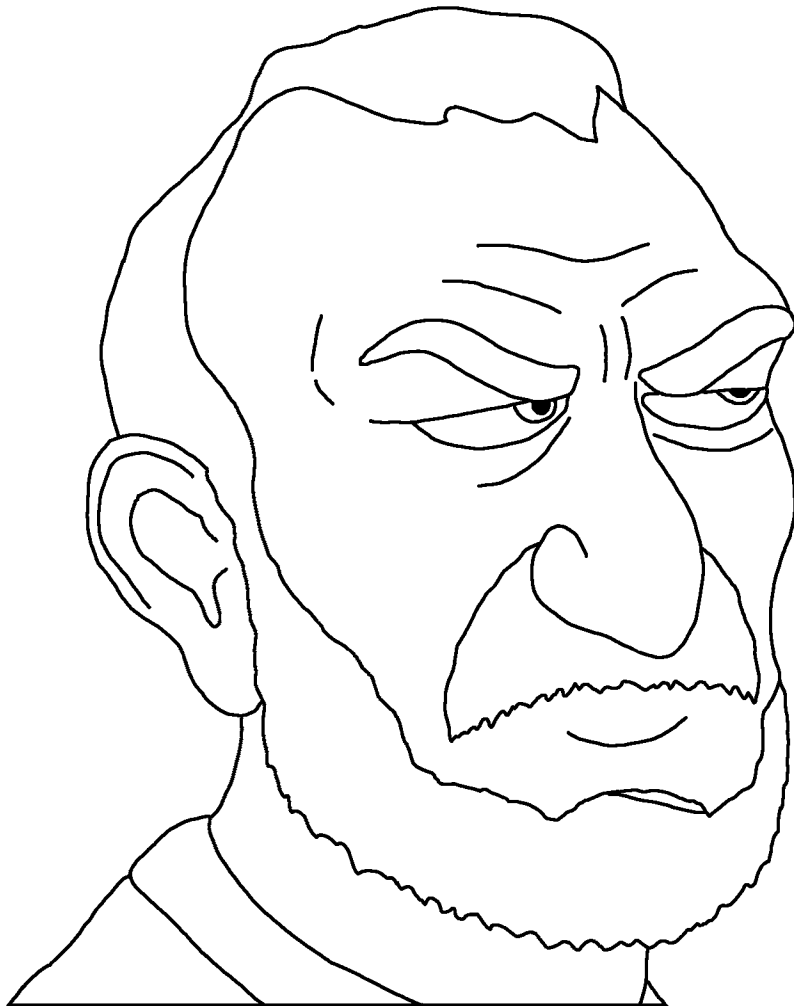

Kuki Yona yarakaye?  
Yabwiye Imana ati "nzi yuko  
uri Imana y'ibambe  
n'imbabazi, itinda kurakara,  
ifite kugira neza kwinshi."  
Mu yandi magambo, Yona  
yari azi ko buri gihe Imana  
ibabarira abantu bihana  
ibyaha byabo kandi  
bagakurikiza Ijambo ryayo.  
Uko bigaragara, Yona  
ntiyakundaga abantu b'i  
Nineve. Ntiyashakaga ko  
bababarirwa.



Yona yarakariye Imana cyane ku buryo yavuze ati:  
"Unkureho ubuzima bwanjye; kuko urupfu ruruta  
ubuzima."



Yona yari yicaye inyuma y'umudugudu, ategereje kureba icyo Imana iri bukore. Imana yaremye igiti gifite amababi manini. Cyakuze vuba cyane, maze kimuha igicucu umunsi wose.



Bukeye bwaho, Imana yohereje inyo, zirya icyo giti.  
Hanyuma Imana yateje umuyaga mwinshi cyane,  
maze Yona atangira gutekereza ko agiye gupfa.  
Ibyo byose byatumye Yona arushaho kurakara.



Uwiteka abaza Yona ati "Mbese urabikwiriye kurakara bene aka kageni?" Wumvise ubabariye uwo muzabibu utari warakoreye kandi utari warateye. Ni byo yavutse mu ijoro rimwe,

agapfa mu ijoro rimwe.

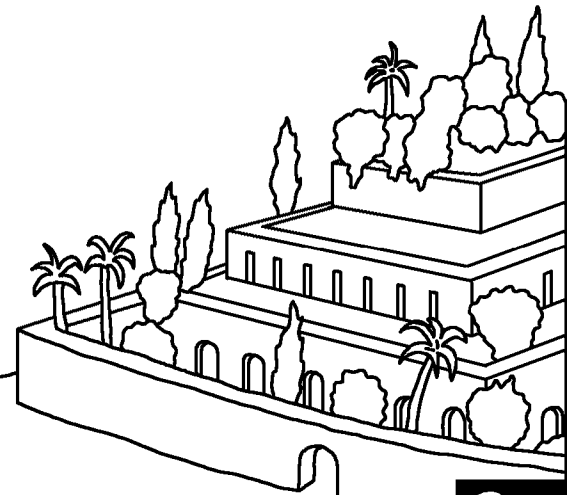
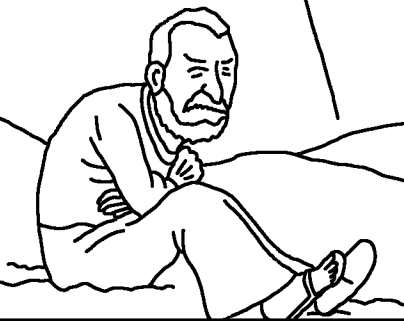

"Kuki ntagomba kugirira  
imbabazi Nineve, uwo mujyi  
ukomeye, ufite abantu  
ibihumbi?"



Yona n'ifi nini

inkuru yo mu Ijambo ry'Imana, Bibiliya

Yavuye mu gitabo cya

Yona

"Guhishurirwa amagambo yawe bizana umucyo."  
Zaburi 119:130





Iherezo



26

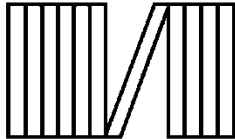

60



Iyi nkuru itubwira iby'Imana yacu  
nziza yaturemye kandi ishaka ko tuyimenya.

Imana izi ko twakoze ibintu bibi, yita icyaha. Igihano cy'icyaha ni urupfu, ariko Imana iragukunda cyane kuburyo yohereje umwana wayo w'ikinege, Yesu, apfira ku musaraba maze ahanwa kubw'ibicumuro byawe. Hanyuma Yesu arazuka, ajya mu rugo mu ijuru! Niba wizera Yesu kandi ukamusaba imbabazi z'ibyaha byawe, azabikora! Azaza, abe muri wowe, kandi uzabana nawe ubuzira herezo.

Niba ushaka kuva mu byaha byawe, bwira Imana uti:  
Ku nshuti yanjye Mana, Nizera ko Yesu ari jye yapfiriye kandi ko uyu munsi ari muzima. Ndakwinginze ngwino mu buzima bwanjye, mbabarira ibyaha byanjye, kugira ngo none aha mbashe kubona ubuzima bushya, kandi umunsi umwe nzaze kubana nawe ubuzira herezo. Mfasha kukumvira no kubaho ku bwawe nk'umwana wawe. Amina.

Soma Bibiliya maze uvugane n'Imana buri munsi! Yohani 3:16

