

www.BibleForChildren.org



Zion 14



Yaq Yesu manqat nøme gezø-ein, “Zo mbøni bezøvã. Geté zo Mbumbukiam zó-unimanqatiním. Neka até no-á, vø-unimanqatinim. Noge Tat-qa khoev-te, kougiap kopoáv. Amba mbain tøgonin, no av nqægo ambá nøzømbé-einák.”



“Yaq no tømamá ndógo, zo khoev nomøzø-khakheinám.
No tænav ndøgo, khoev vømøzø-khakheinām, yaq
nango ndøtøndo-veséz, zo vøekhatōb, nøkezan-te.
Yaq até zó-a, tønégó, ma no tøtegoat.”



No Zión. No zogé Klisten zøfú. Yesu mokho-te,
ni kopó. Te mokho-te, no zo namba, viniv kopó
sizimu-eqawát neka Mbumbukiam-qa

Megeat Matev mokho-te
sa nqāzīmū-yāgē, neka



bazaføgakh-us sa
nqāzīmū-wānīāp.



No Mbumbukiam-qa manqat qate-manqatam neka
ezoqa Yesu-qa yaq-te vøtē-zømesimam, ta
zapaya ndøgo, no Patmos manqei

bawa-té
gimø-ogenonám.

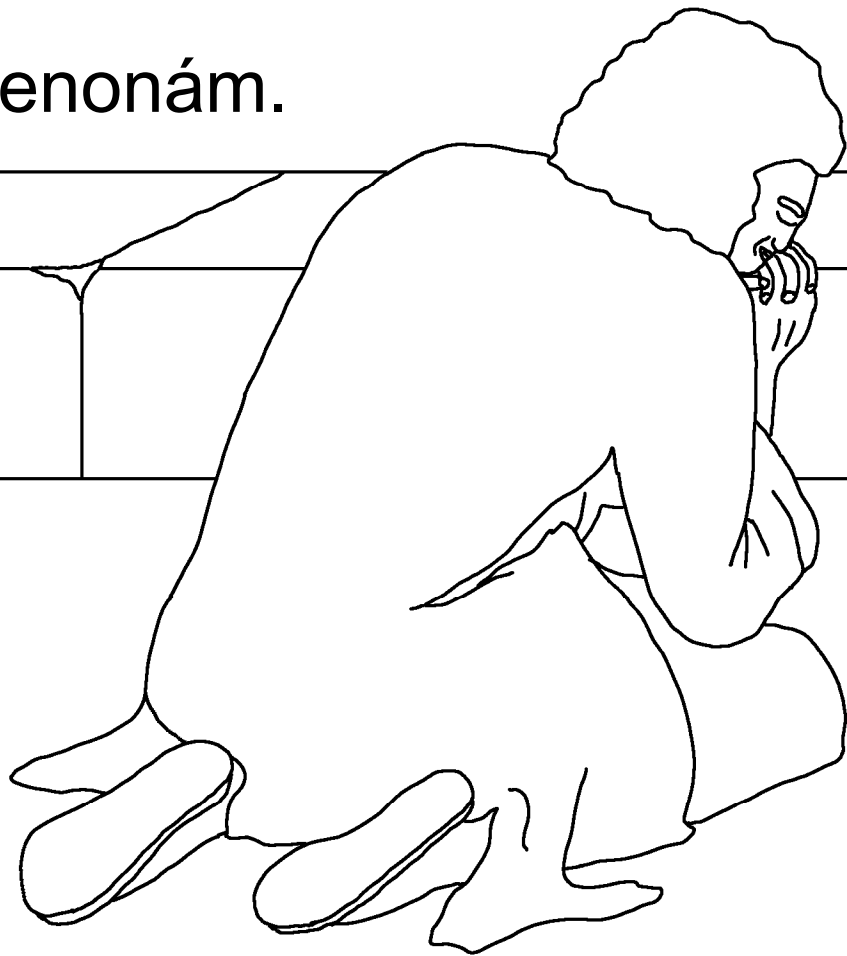

Yaq Mbumbukiam-ge Nqova, até gendego, no
võndapan. Yaq nqáe! No yan-te ndøgo, kawa
ezoqam-qá qonam nonqo nøqeív, ezoqam vó:qotam.

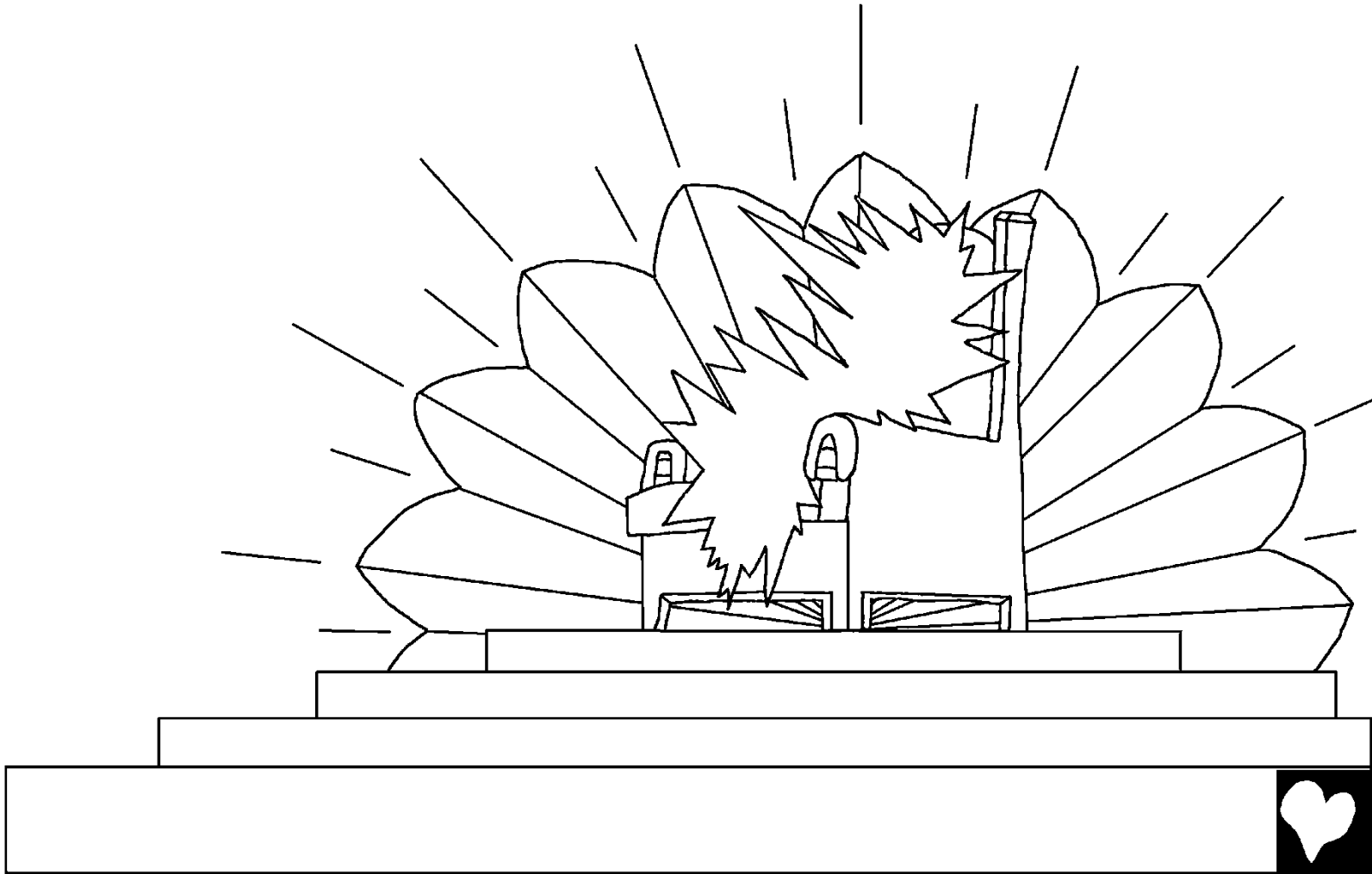

Yaq tæ-ewág ndógo: Gigiap ate ndi:gu, yan-te ngo:go
neka manqei-qape-te ngigu neka manqei-qape
mokho-te ngu:gu neka ndaola-te
ngigu, ouv ndøqaqaemám. Āv
gini-qaqaemám nqægo, “Ndego
qonam nonqo-te ndo:qomat neka
Sip Nakhasam, khanakhanakh
manqat neka
vizap matev
neka iz eqawat
matev neka
bazaføgakh
tiqá.
Miavmiáv.”

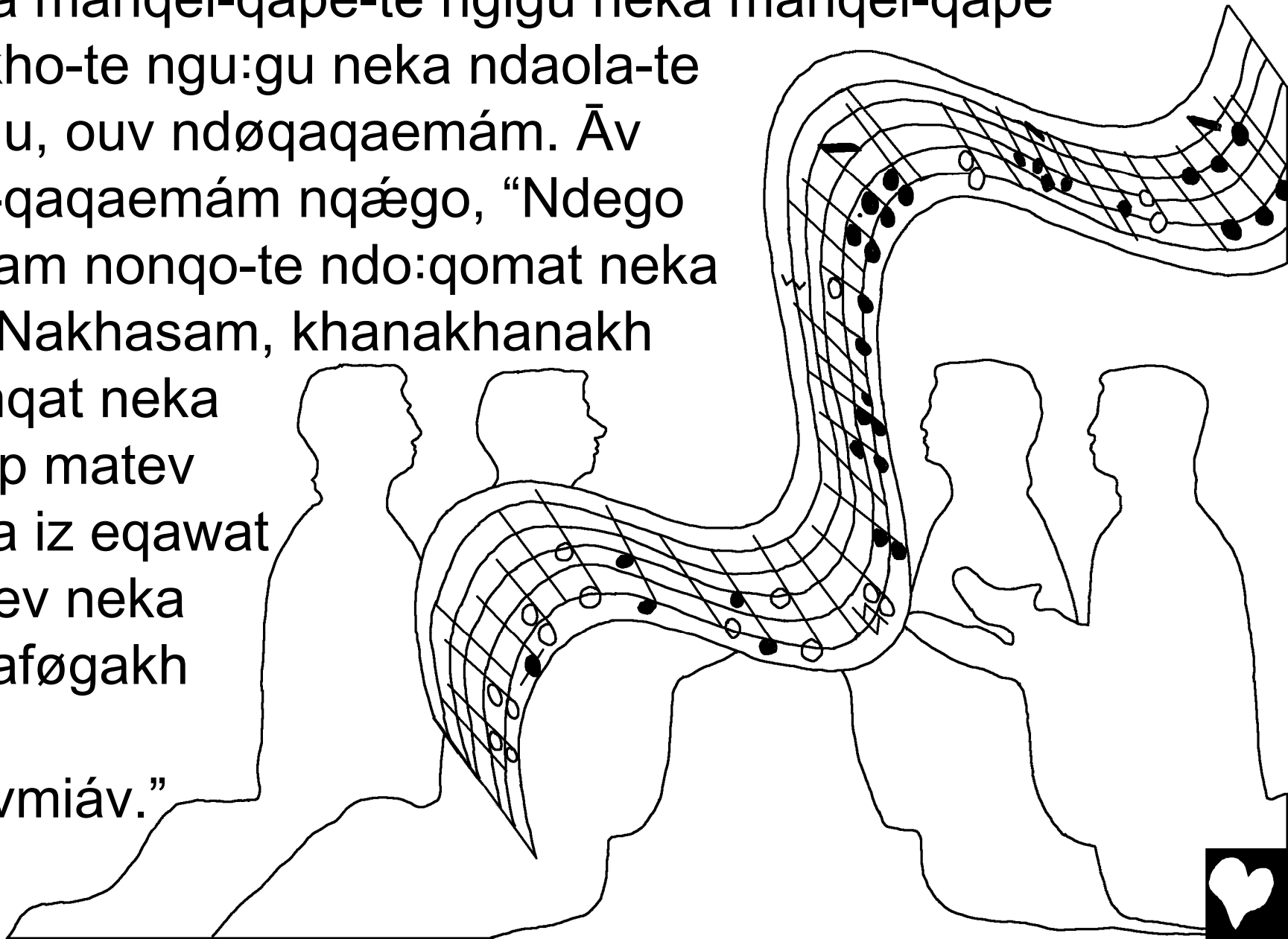

Yaq no Mbumbukiam-qá Zelusalem taon ndakinak
nøqeív. Mbumbukiam-té qandovís, yan-te nqo:go.
Khakheitáp neka bugug keogé. Ate av-té,
mbasønakam bugug keoge nduigu, anganea tundaf.
Yaq no manqat kandambaqape nø-ewág.

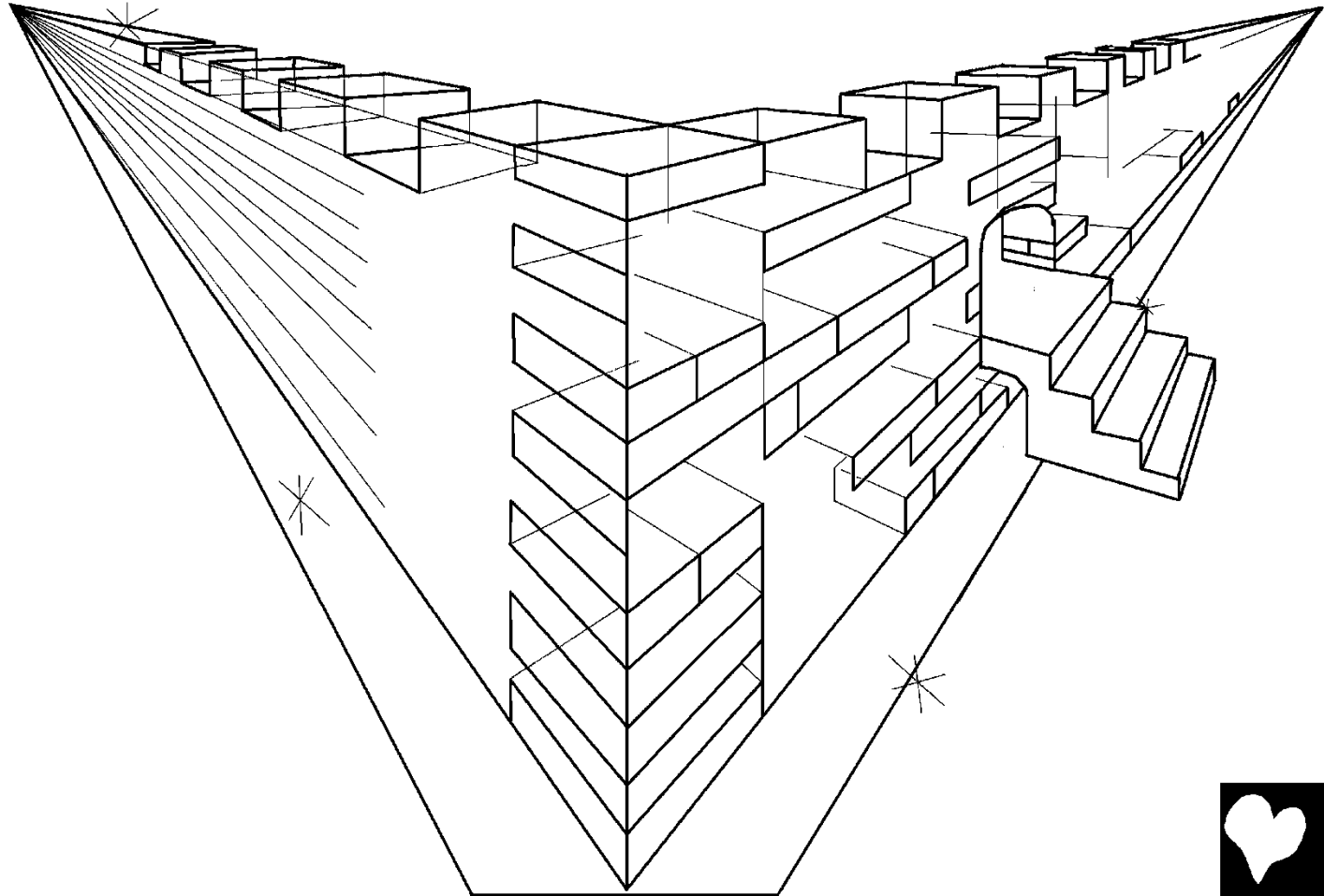

Kawa ezoqam-qá qonam nonqo-té qando-manqatát.
Āv qande-eín nqáego, “Nqáe! Ndakin Mbumbukiam,
ezoqám namba mé:goát. Ndego namba mé:yagát.
Neka ndigu tegí ezoqam ndógoát. Mbumbukiam
ekezan, ti namba mé:goát, neka ndego tigi
Mbumbukiam
vógoāt.”



Yaq ndego enzol ezoqam, no kea me:nømánd.
Ta ibøkha ndøgo, ezoqa khandi zø-etoám.
Ndøgo bæbæs-qapé. Andé glás. Nqanek ibøkha,
kawa ezoqam-qá qonam nonqo-té qando-okhó,
ma Mbumbukiam neka Sip Nakhasam
ndiqonøve.



Nqanek taon, khøuwa neka løvøyak mbaín, waev tømbo-etoumat. Ndøgo kopømbá. Zapa ndøgo, waev Mbumbukiam-qá waev mbo-etoumatún. Neka Sip Nakhasam, ndego andé taqá lampá.



Geté gekha gigiāp ndøgo, Mbumbukiam-qa bøi-te
khavim-us ndøgo, kopømba mbaín, tø-oe. Neka
ezoqa ndigu matev soqøsoqa
ndimatanam o khavozam
manqat ndimanqate,
ndigu ma gé-ozák.
Ti-mba ndígu fi-óz,
tiqa iziz Sip
Nakhasam-qa khandi
mbuk-te ndøpeawap.



“Ndego tiqa bøi-te, bøi einu ate
ndægo zóvuogím. Løvøte matev
nøme mbaín, segégoát, neka
até mbøni vaev matév-a, neka
eiv neka nqosøgeap nøme
mbaín. Matev av nqægo, av
bugukhokhof qægoam,
møndømø-navøém.”



Neka ta taon-te ndøgo, gigiap o matev nøme mbaín,
Mbumbukiam-qa qaqa mokho-te ndøugu. Kawa
ezoqam-qa qonam nonqo, mú:goát, ma Mbumbukiam
neka Sip Nakhasam tiqonavat. Ezoqa ewaqape,

tisokhoat, ndigu
Mbumbukiam-qa
sasai ndøgoát neka
vømbó-vizupāt.

Ndigu bugug
gembóqeivát
neka teqa iz
kawa-pap-te
vøzømbó-
peaupāt.



Neka no løvøte ezoqam nözömét, iz-akhayapak nekā khokho ezoqam. Kawa ezoqam-qá qonam nonqo megemege-té gono-waniapám. Yaq enzol ezoqam, mbuk ndømboqogimém. Mbuk nøme gimboqogimem, khandi mbúk. Yaq Mbumbukiam, løvøte ezoqam, matev, āv gezømbe-geveá, av mbuk-te ndøugu qøupeaupam, av matev gi:matønnumam. Yaq gekha ezoqām ndego, teqa iz khandi mbuk-te peawapøteav ndøgo, ndego gøinam kewan-té ginø-oginám.

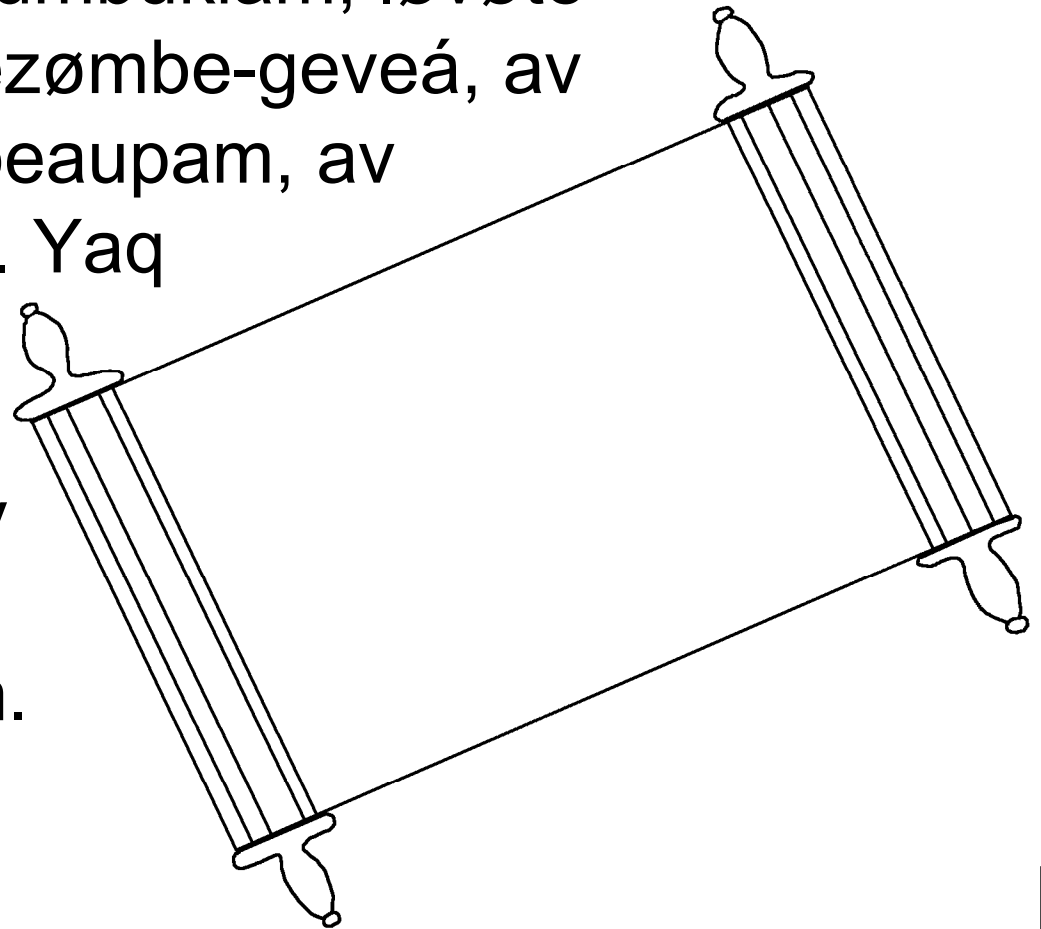

Mbumbukiam-ge Nqova neka Sip Nakhasam-gu
sævam, āv gini-manqaté nqægo, “Vòndoqáv!” Neka
gekha ezoqām ndego, nqanek manqat te-ewagat, āv
geabete-manqaté nqægo, “Vòndoqáv!”

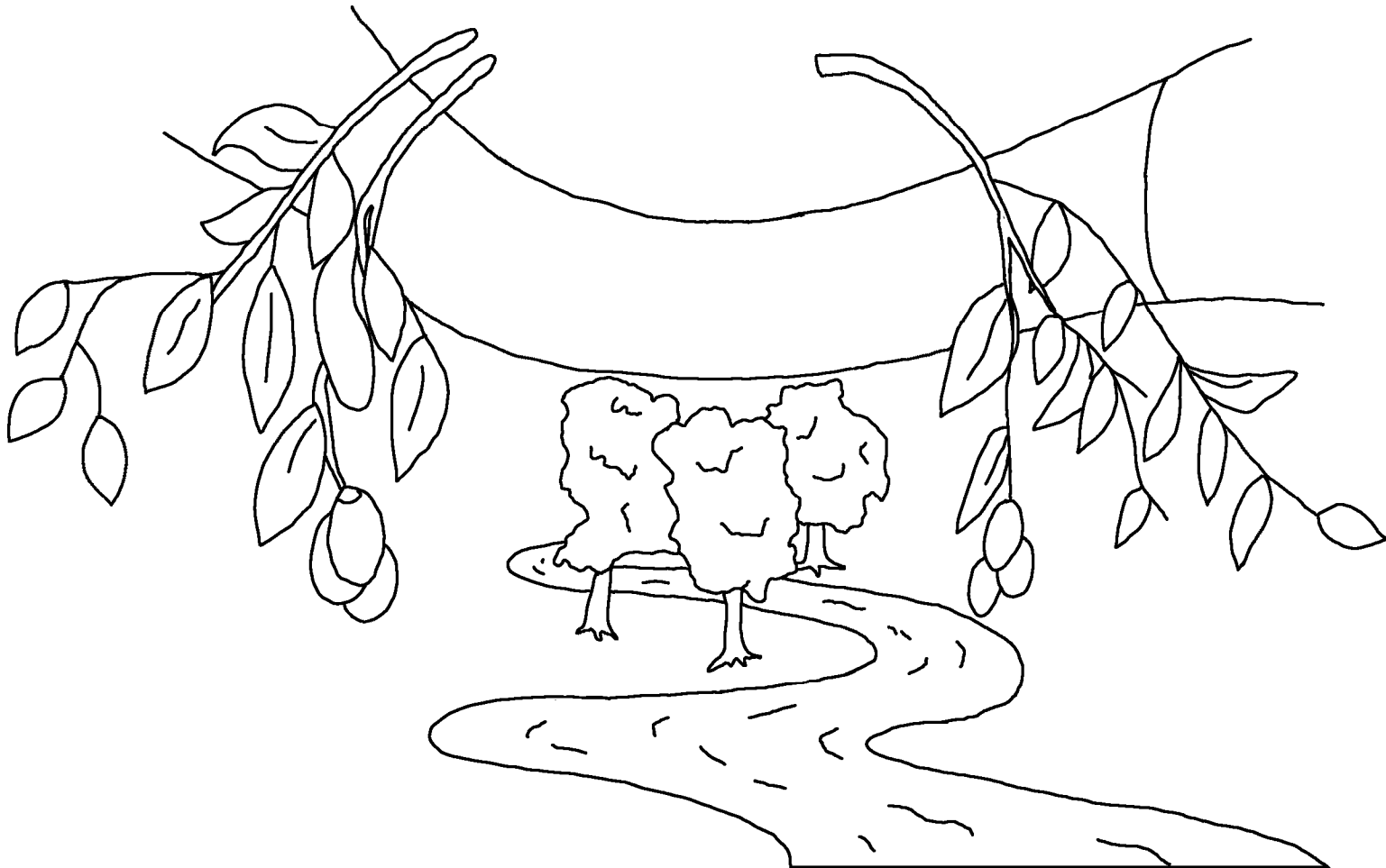

Neka gekha ezoqām ndego, ibøkha naq
ndømbopapat, yà betøndowáv. Poev tømbo goat,
ibøkha bē-izam, ndøgo khandi ndøzø-etoam.
Yaq-mbá segé-izám.

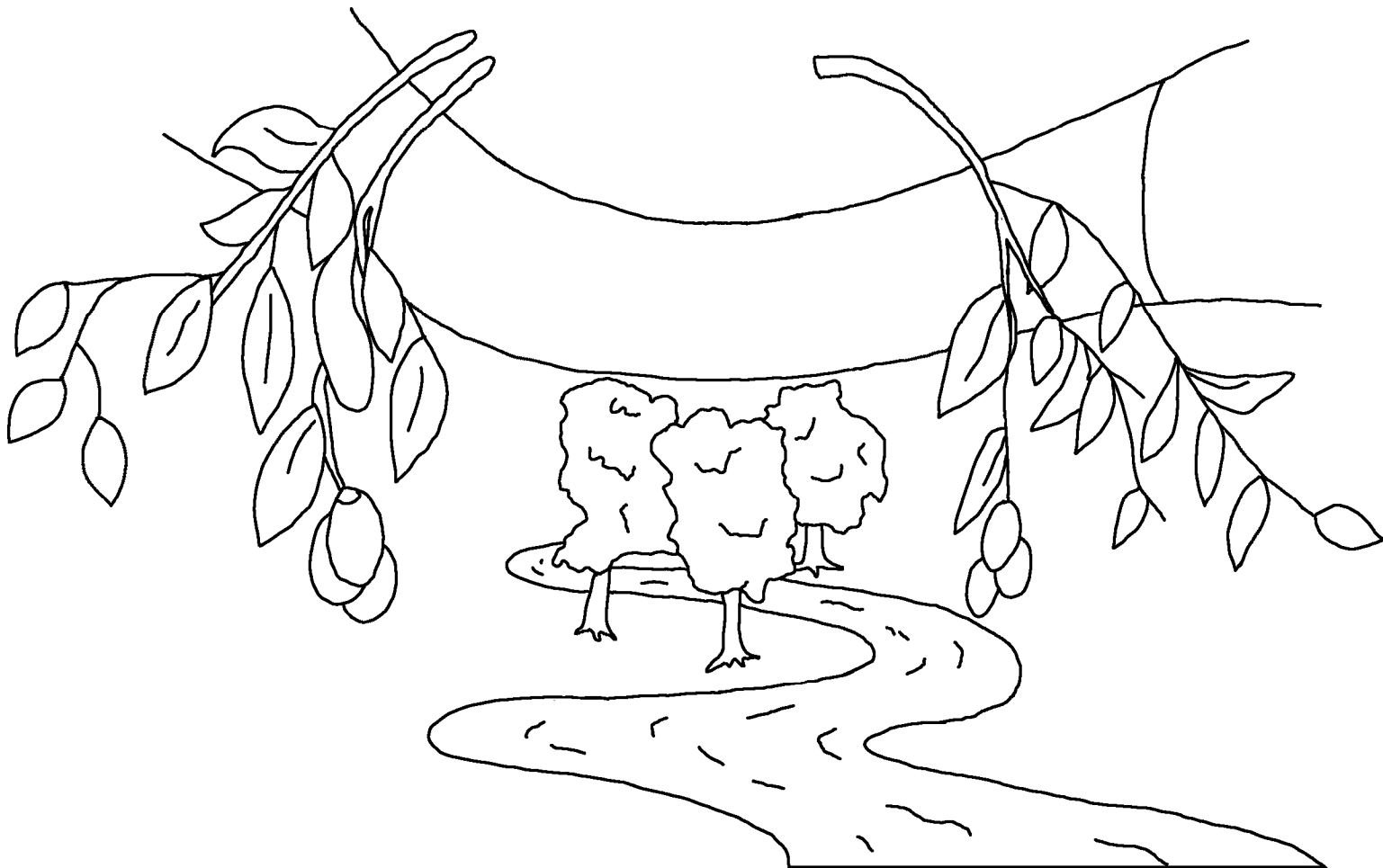

Mbumbukiam ni manqei-qape ezoqam,
teqa kuku matev kandambaqape, āv
gininømánd nqægo: Ndego ekeza Yo
kopo ni-etoám. Yaq gekha ezoqām
ndeogo, te-unimanqatin, ndeogo
soqaqape géqeivák, geté
khandi miavmiav
ndøndáp.



Lom 3:23

Ni ezoqa ate nqazi:gu, manqa-zapazapa-ús. Ni zibusøtøvém, matev, av Mbumbukiam qambøe-pøovam. Yaq ni ambá av nqægo, Mbumbukiam-qā waev-tē qazu:yagē.

Lom 6:23

Zapa ndøgo, manqa-zapa-qa yaq-fia, løvøté. Geté Mbumbukiam-qa etoam matev, ndøgo ni yaq-mba ndini-etoam, ndøgo khandi miavmiáv. Keliso Yesu mokho-té qazindapé, ndego nigi Evezøza.

Iblu 9:27

Ezoqa ewaqape, bèpakhaezát. Kopo mé:nanimát, yaq Mbumbukiam-qa manqa ovøyam-te bemø-itanat.



Efesus 2:8,9

Zo Mbumbukiam-qá kuku matev-té qazøte-khandī:z, zo Yesu qazo-unimanqatinim. Zo ambá av nqægo, zøkeza matev matanam mokho-tē qazøte-khandī:z. Āv taoká. Ndego zo khandi, yaq-mbá segezø-etoám. Zo ambá av nqægo, sasai-qape zøte-khanøzēm. Yaq nakémbá, ezoqa kopømba mbaín, ti:khambuvupat.

Lom 10:9,10

Qo qakeza tou toqote-ein, av nqægo, “Yesu ndego Evezøzā,” neka mbøni mokho-te voqó-unimanqatīn, av nqægo, Mbumbukiam Yesu møndø-khandī:v løvøte-te, yaq qo ndòqo-khandī:q. Zapa ndógo, gekha ezoqām ndego, teqa mbøni mokho-te nde-unimanqatinat, ndego gé-ndaføyamba-év, Mbumbukiam-qa bøi-te. Neka gekha ezoqām ndego, teqa tou-te ndemanqate, av nqægo, “No nò-unimanqatināt,” ndego ndøkhandī:v.



Zion 3:16,17

Mbumbukiam ni manqei-qape ezoqam, teqa kuku matev kandambaqape, āv gininømánd nqáego: Ndego ekeza Yo kopo ni-etoám. Yaq gekha ezoqām ndego, te-unimanqatin, ndego soqaqape géqeivák, geté khandi miavmiav ndóndáp. Mbumbukiam ekeza Yo, nqanek manqei-qape-te, ambá ta zapaya ndøgo tendē-khofotav, manqei-qape ezoqam, manqa ovøyam-tē genø-āb. Geté ndøgo tende-khofotáv, manqei-qape ezoqam, te mokho-te gékhandí:z.



1 Zion 5:11-13

Manqat ndøgo, Mbumbukiam ni-te nde-unimanqatinat, nqáneek: Ndego ni khandi miavmiav ni-etoám. Neka nqanek khandi, ekeza Yo-qá mokho-té qanu:gú. Ezoqam ndego, Mbumbukiam-ge Yo ndembogo, ndego khandi miavmiav mbogó. Neka ezoqam ndego, Mbumbukiam-ge Yo mbain ndego, ndego khandi miavmiav, mbaín. No nqanek manqat tæzømbe-peawám ndógo: Zo ezoqam, zo Mbumbukiam-ge Yo ndozo-unimanqatinat, zo vøezøté, av nqægo, zo khandi miavmiav, ndøzøgó.



Zion 14; 2 Kolin 5;
Manqat Qandoveveam 4, 21, 22

Storyline by: Edward D. Hughes

Illustrated by: Lazarus
and Alastair Paterson

Adapted by: Sarah S.

Kuni-Boazi NT (kvg) ©2018, Wycliffe Bible Translators, Inc.
All rights reserved.

<https://www.bible.com/bible/2085/MAT.1.KVG>

©2026 Bible for Children, Inc.

www.M1914.org

www.bibleforchildren.org

