

www.BibleForChildren.org



loanes 14



Tie, Iesu la inagat tiesong me lop o usingnualap gare ro, “Baraba giginam dalap mi ga agatming papot. Naganming ira Morowa ga naganming gat ira ruo. Na luguan ang Mamo ruang ame papot ma kabilip. La karuk, tie eba tale miralava.”



“Eba rala ga eba orangarang pianam ming. Ga leba rala orangarang pianam ming, tie eba ina terigirang ga milagirang me toi, meba gat mimi ba le mionang na urie pianam la tunama una.”



Turuo loanes, turuo papa ming iro nagan ira lesu.
Buavio giginanim iat ga bunama upat
unualeap ang Morowa. Ga bubuor

ganam la bume dus
maranit ga iat buavio



ngitngit, memani
naganpang ira lesu.



Tume bais o ties ang Morowa ga tume ovaik bais
ula mumuru ang Iesu. Are ratmat ga teip onim
Rom la tokalameng ga tomaiabu na

luguan o arubu abuo iriro
ailan la meiva Patimos.



Pa talet kagat, Muranama Ila Babai la betong toi na kukunim ang. Pa na panbinim agimarung non luaga ang orong la ut, ga non migana la man unama ubuo uriro nunamap.



Ga tupto ties maiong mirier pagap la makosarong
Morowa, la maiot na panbinim ga maiot na kimanam,
ga mirie la maiot tatang upat
kimanam na pianam la maionama
teip mila mevara una, ga na
pirom.



Eva, mirier pagap ganam la maiot na mirier napup
ganam la pumaiara gare ro, “Morowa la unama bo
luaga ang orong ga Poi ang sipsip
gat, eba liarang urier temaieng
gano ga tenubap o uvien ga bonim
ula kakanu ga urier kukunim gano,
puoieng atatan makin.”

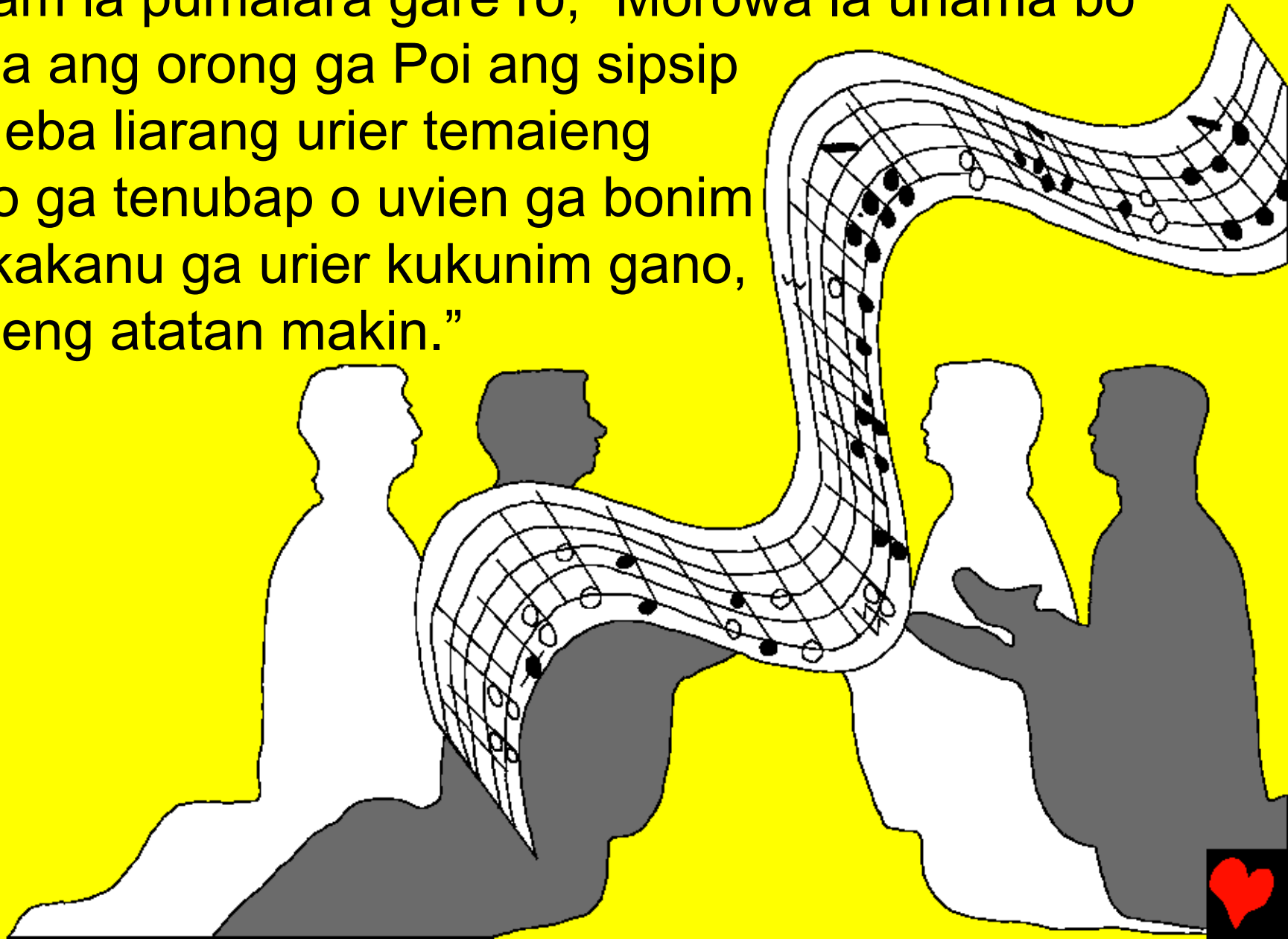

Ga ogimarung uriro taun ula babau, urie Ierusalem ula nou la maio aun Morowa na panbinim ga muio to lourup. Ui maset gare magabun la namo magieng ga iabuam sasaip mila mumurum ga urangaieng meba auanila lai iang.

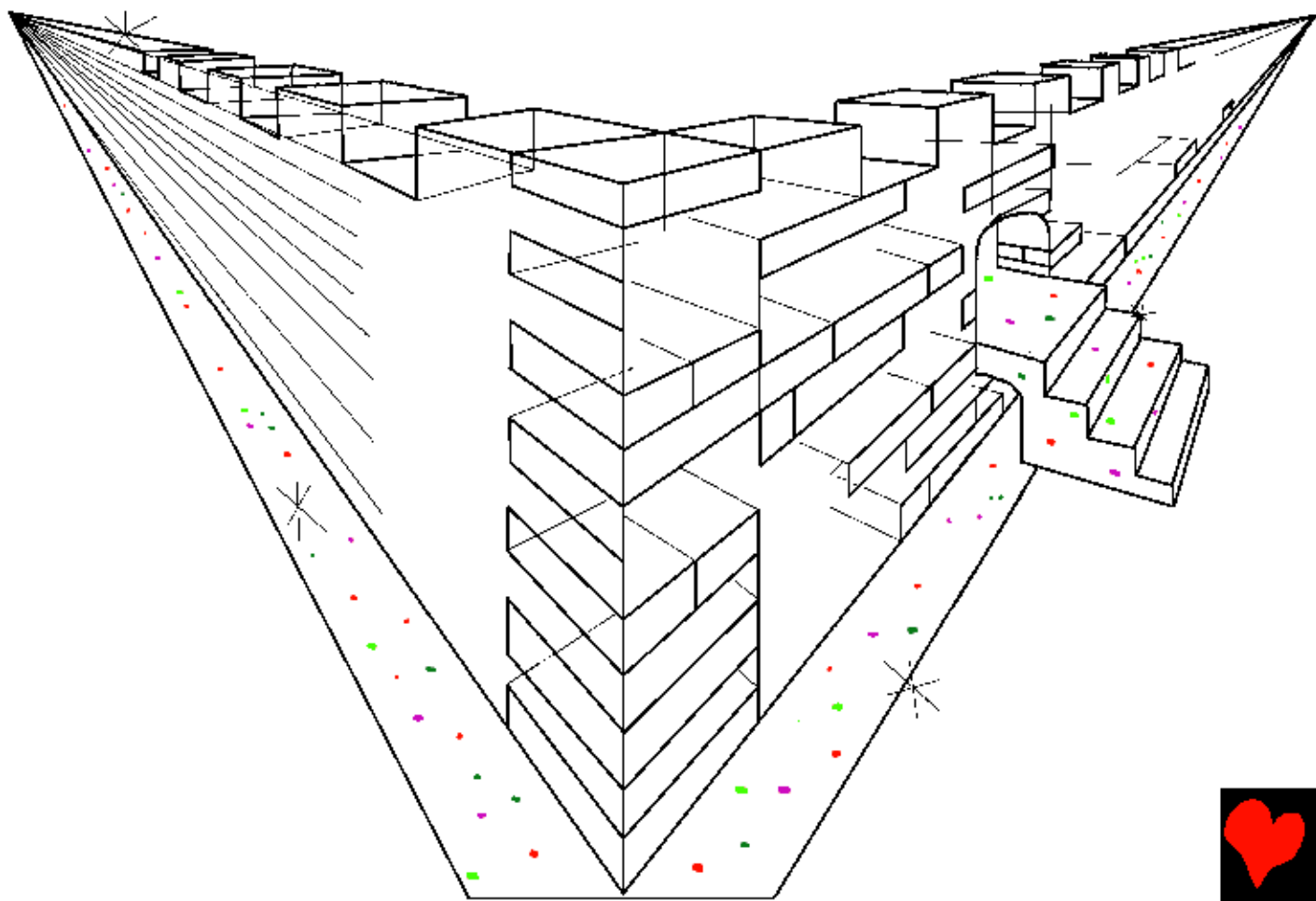

Ga tupta non la unama kabirana a iriro luaga ang orong la tiesong maranit are ro, “Miptang! Titot nunamap ang Morowa la unama ga teip ga magaulap! Ga eba onang kabirana ma, ga eba maionang teip ga magaulap am. Eva, Morowa kan la eba onang ga mirie ga eba irie ba Morowa maiang.”

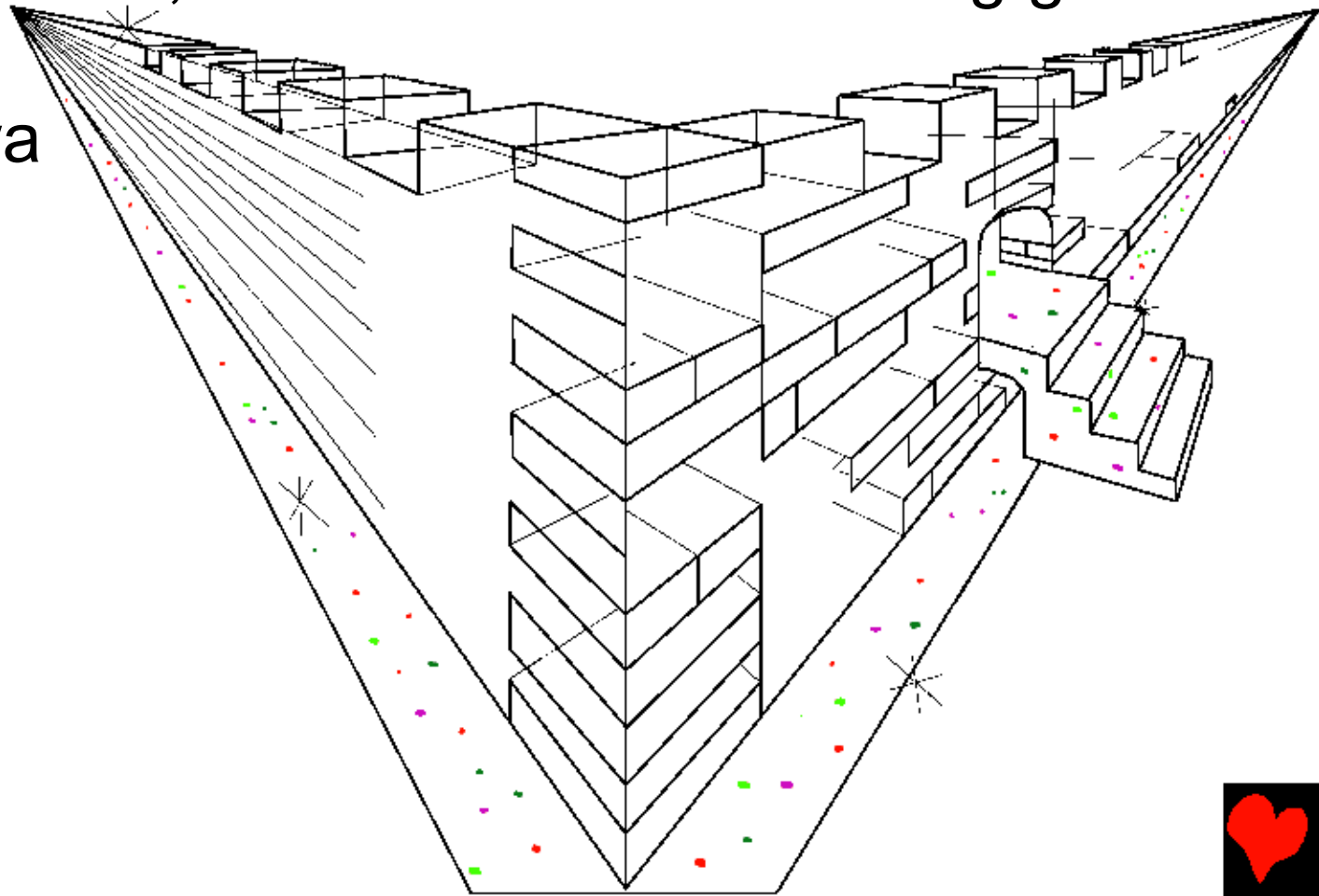

Tie, tubiat a iriro paga, iriro angelo kabirana ma gamura ma angelop la tosinguala o non burunam la ime ialo ninimiap la iot atatan makin maun teip ga magaulap. Babau gare tilagu ga mitara ililakieng. Muana o uriro danuot la betieng na luaga ang orong Morowa ga Poi ang sipsip.



Are ratmat ga muabari ga ulang la tala gat lilabie na
uriro taun. Karuk. Lalabie ila kakani ang Morowa ga
lam ang Poi ang sipsip litie kan lilabie o uriro taun.



Pa pagap mila papalim ga inamaniap la mime makosar non ara non ara tavukup mila kiram o mulinubap, ga inamaniap la mime ties o kakarabunim, mirie la tala kan puomeng meba maiobung na uriro taun. Karuk kan migat. Inamaniap it mila mamirong Poi ang sipsip bop ma na babam o ninimiap, miriet mi la eba mela maiobung na uriro taun.



“Ga eba mabalak ang kup na irap ma. Ga tala gat ina mevara, ga tala gat giginam dalap ma ga tala gat ina meliba ga omela ngitngit gat. Karuk. Memani, miriro giginanimup iam natauan kimanam la nam ara.”



Pa mirier pagap ganam la tale naong Morowa maime
ga mirier inamaniap ganam eba makaranang, miriro la
tala kan maiot tie. Karuk. Na uriro taun, Morowa ga
Poi ang sipsip eba lionang na luaga ang orong ga
ulialeng mabuo teip
ga magaulap la
maionama na
uriro taun.

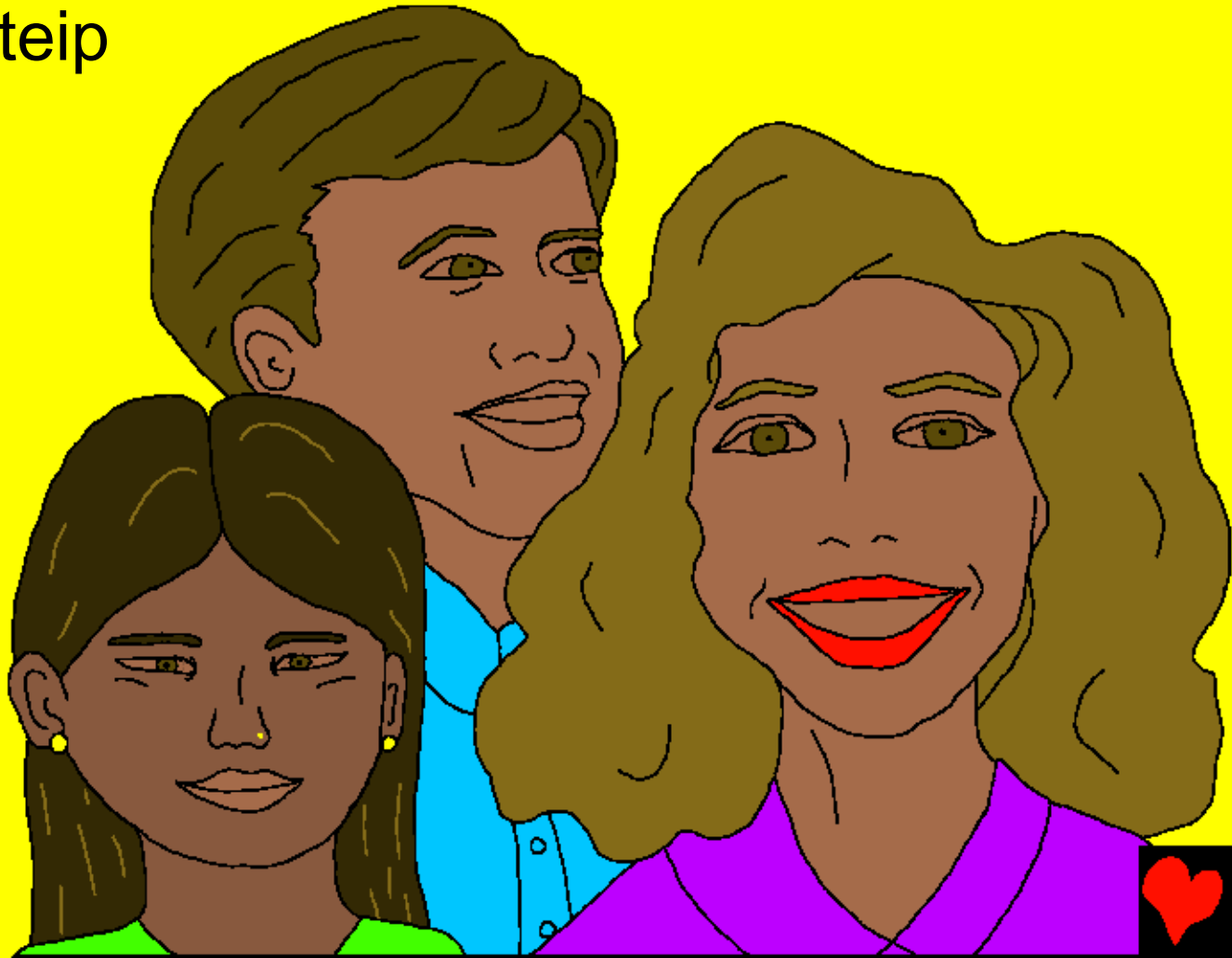

Ga teip liam o ubi la eba lotumeng me ai. Eba
ogimameng pava a. Ga bonim a la eba omirmeng
na pavap ma.

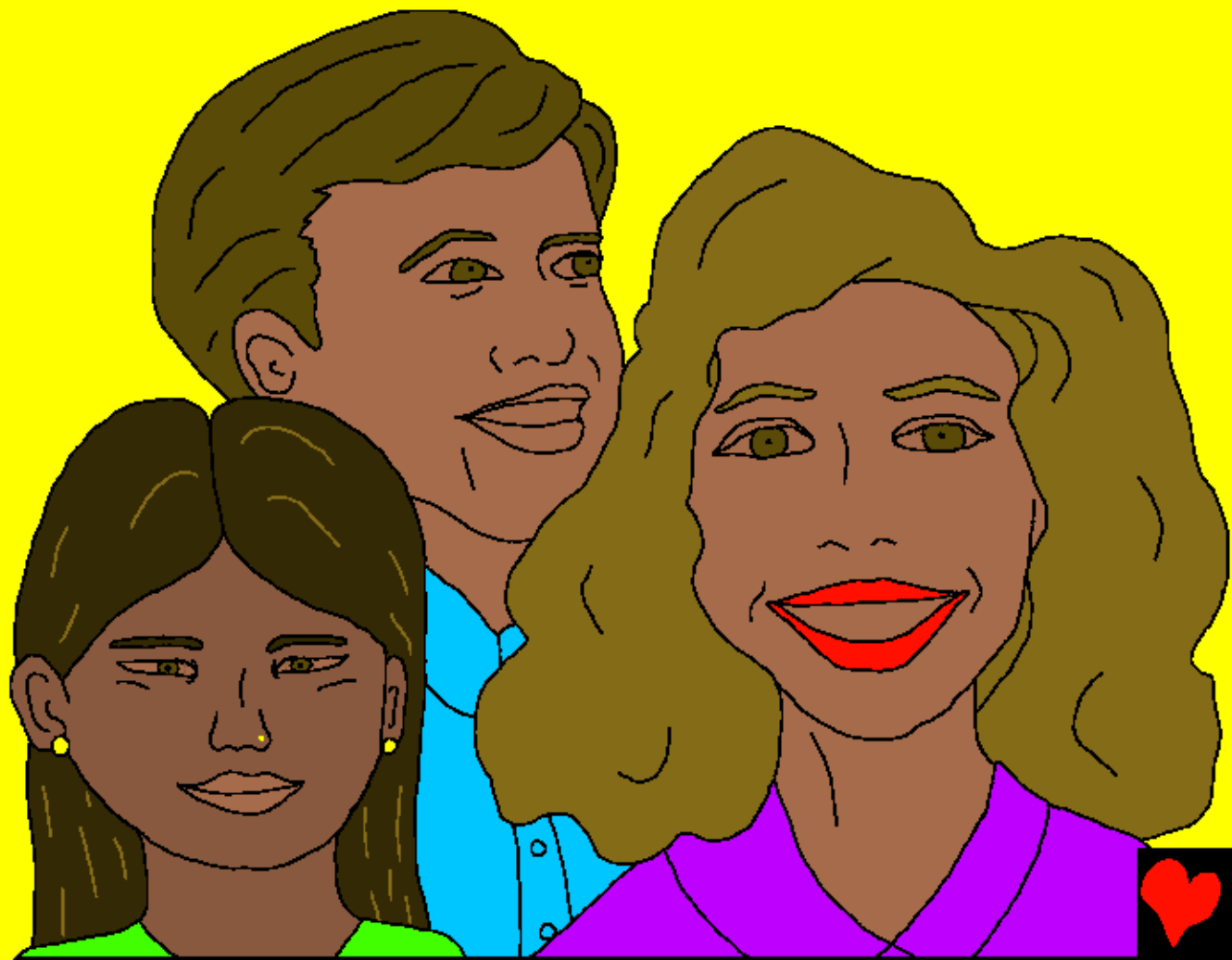

Ga magimarung teip ga magaulap la mevara ra tinan,
teip ga magaulap la memaning bonim ga teip ga
magaulap gat agarit. Man dusemeng kagarat ai iriro
luaga ang orong, pa menavo non babam. Ga ina gat
menavo non gat babam, urie la babam o
niniapi la maiot bop ma teip ga
magaulap mila meinim ga
maionama atatan
makin ga Morowa.

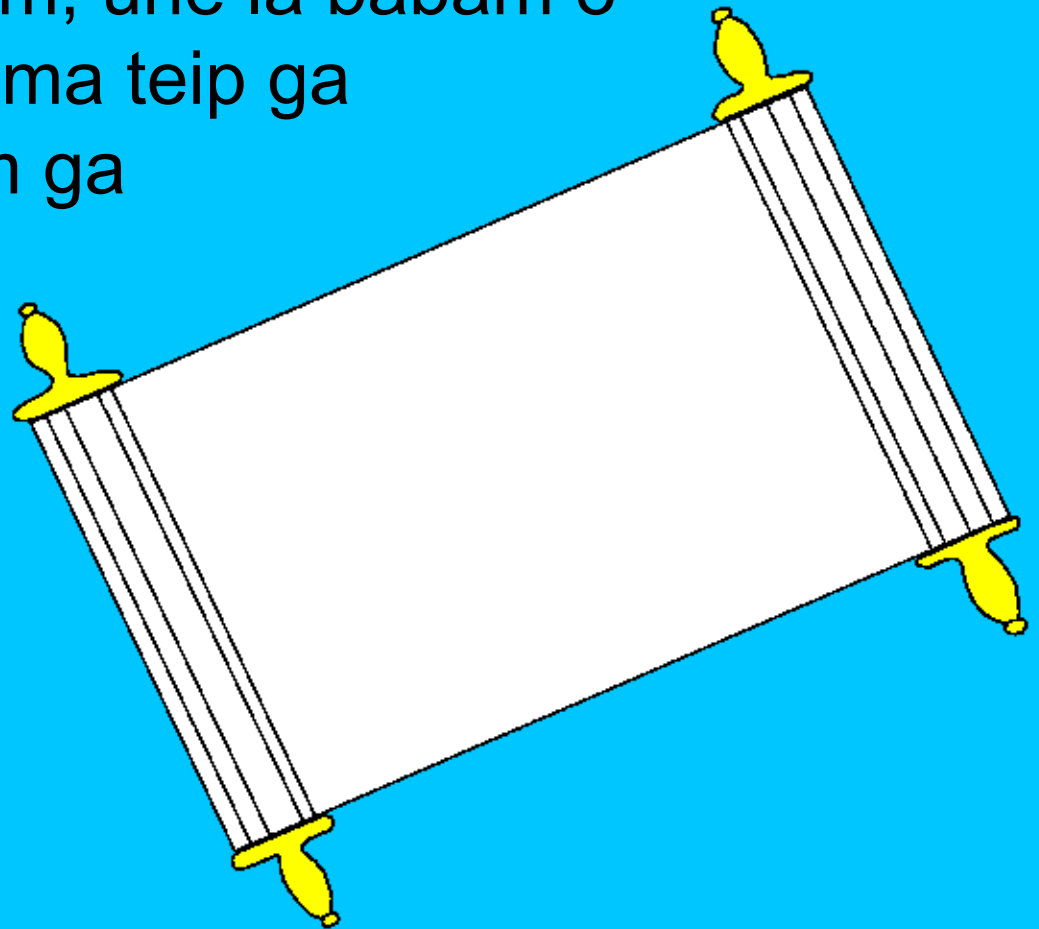

Ga mauluan Morowa tiesiap la mamirmeng na mirio babap ga mavuvuoong mirier teip ga magaulap mila mevara ra me man tavuk la mime akosar. Ga teip ga magaulap ganam la tale maiot bop ma na babam o ninimiap, eba magomeng gat me lourup na kin ula kakanu la ame kit.

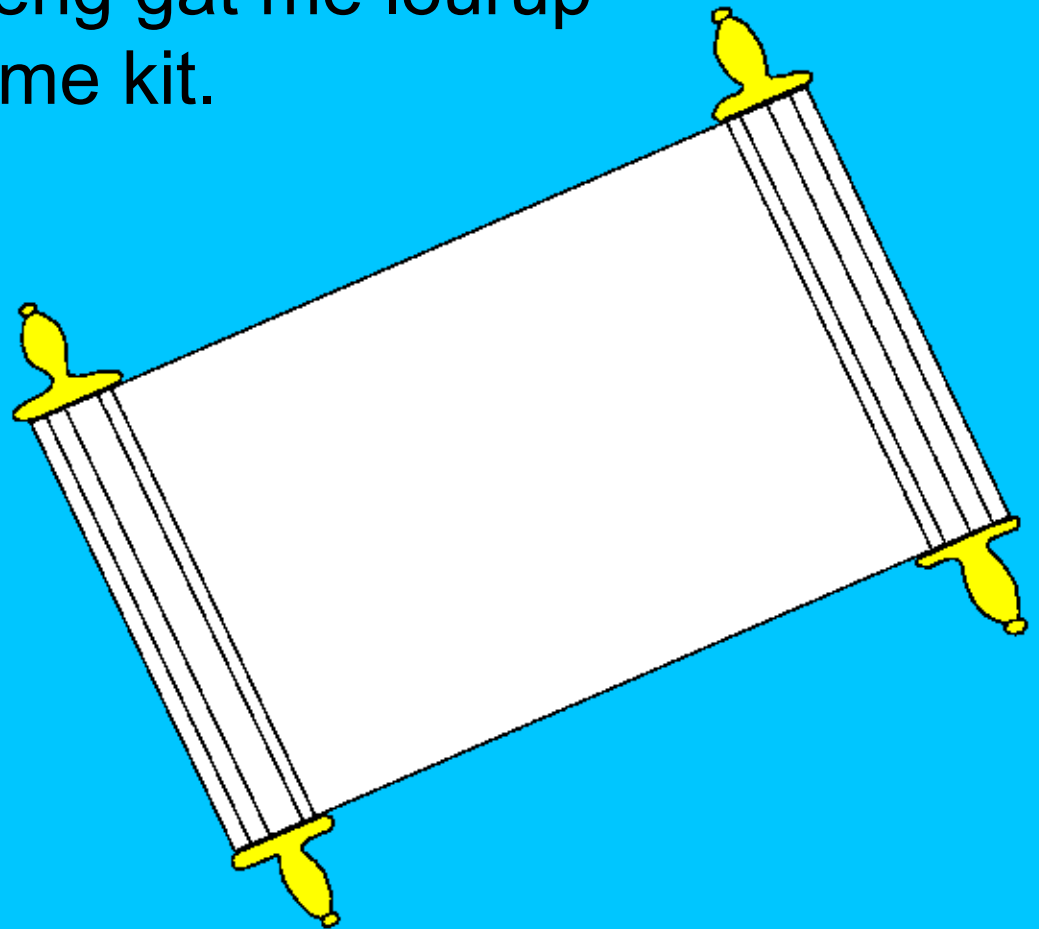

Ga Muranama Ila Babai ga magabun ang Poi ang sipsip la megama, “Munang!” Pa teip ga magaulap la mepto uriro ties ga tiesmeng aime lesu gare ro, “Eva, munang!” Pa aga teip ga magaulap la balakmeng nigunap ma, mumaiong.

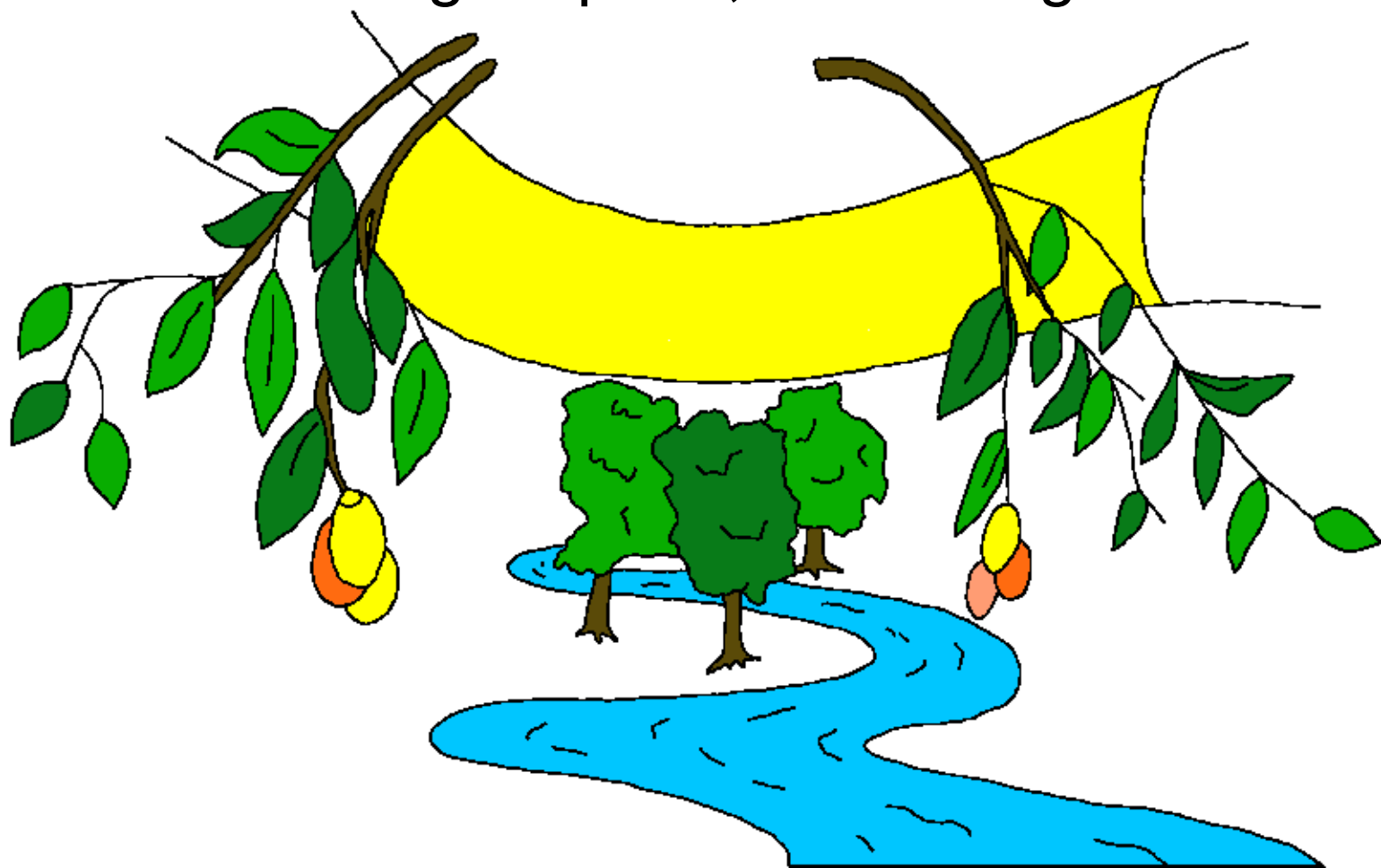

Ga teip ga magaulap la namo tapmaio, mumaiong ga
maiarang burunam o ninimiap la iot atatan makin.
Uriro gare kamniap la karuk o uniap ba o la eba alang
Morowa miun.

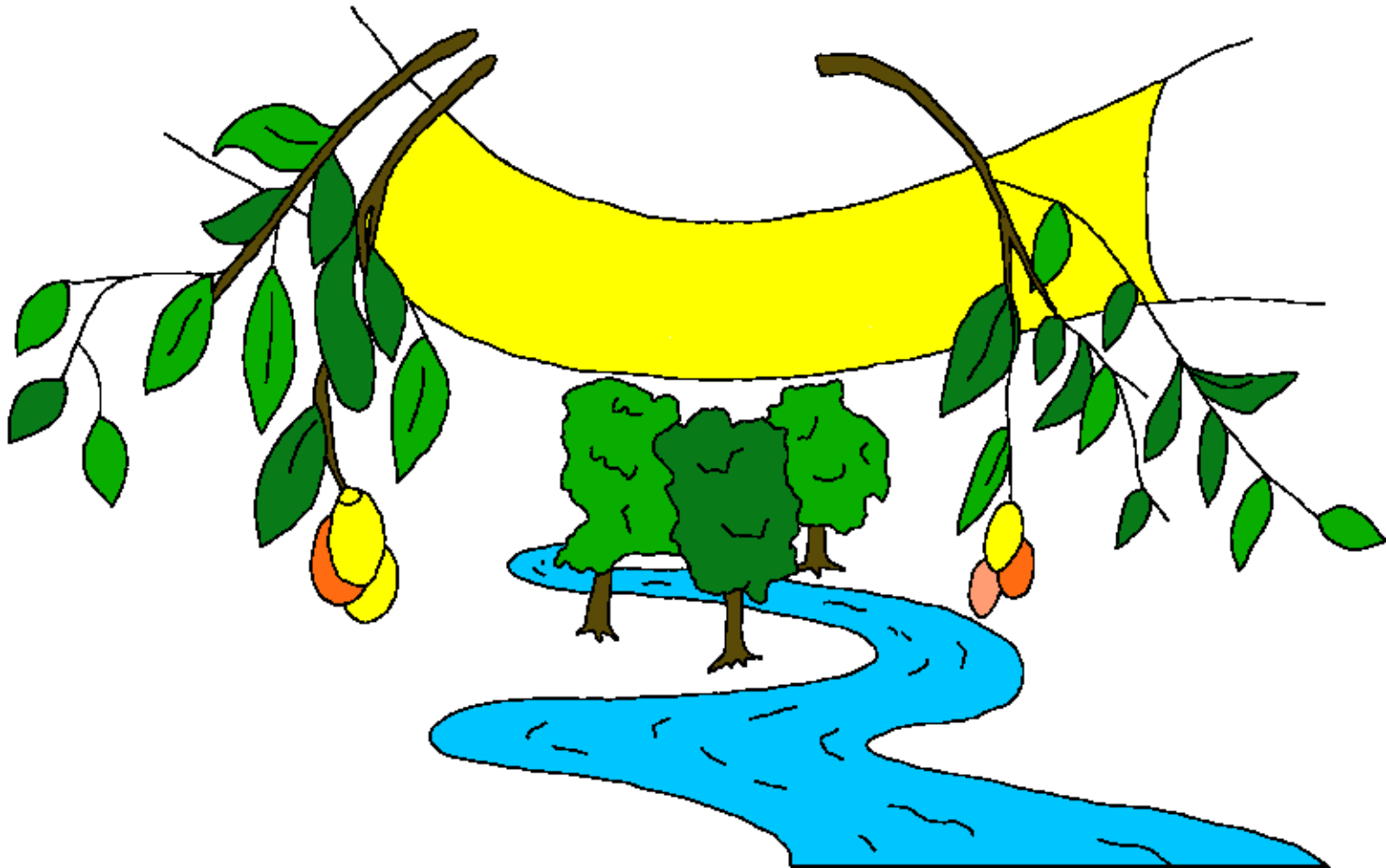

Morowa la amaning it namurit kulot la unama. Pa mitara naong Morowa me mirier teip ga magaulap ganam onim na kimanam. Are ratmat ga uala iriro narit kulot maun.



Okosarong gare tiro me mirier teip ga
magaulap ganam leba naganmeng
ira a ga ameuluo, tala kan iomeng.
Karuk. Eba omela ninimiap ula
iot maset atatan makin.



Rom 3:23

Memani, bubuo inamaniap ganam la okosarbuong ara kirinim, are ratmat ga tale puobuong meba bunang ga Morowa na pianam ang ula ililakieng.

Rom 6:23

Eva, maun inamaniap la mime okosar kirinim, Morowa la ualot uniap o nuvarap ula iot atatan makin. Pa maun inamaniap la mime maionama ga Iesu Karisito Ila Kakani buang, ualot kamniap agarit, urie ninimiap la iot atatan makin ira a.

Ebraio 9:27

Memani, mirier inamaniap ganam la eba meving at narit tara, ga tubiat eba dushman na ties.



Efeso 2:8,9

Irot ubonuvarap ang Morowa, naganming ira Karisito, ga Morowa la ina milagiong. Urio la tale paga mimi kan la akosarming. Karuk. Ualat Morowa agarit miun. Urio la tale betieng gare uniap o ubi la okosarong non migana. Karuk. Are ratmat ga karuk kan a migana ba la puong meba ovienang bonim a kan ga amama, “Turuo kan la ubirung maranit ga bettung ila muri maset na irap a Morowa, are ratmat ga ina tolagiong.” Karuk kan migat!

Rom 10:9,10

Tie, leba baisnang na nanam nuo la uakap a lesu irie ila Kakani, ga na dalap nuo la nagannung ira Morowa la ina imua lesu na una, eva eba ina nolagiang Morowa. Memani, na dalap buo la bume nagan ira lesu la uvara ga ina imua Morowa na una, ga buiva Morowa inamaniap mila puvuvum. Are gat to, na nanamup buo bume ovaik nagan buong gare ro, “lesu irie la Kakani”, ga ina bulagiong Morowa.



Ioanes 3:16,17

“Morowa la amaning it namurit kulot la unama. Pa mitara naong Morowa me mirier teip ga magaulap ganam onim na kimanam. Are ratmat ga uala iriro narit kulot maun.

Okosarong gare tiro me mirier teip ga magaulap ganam leba naganmeng ira a ga ameuluo, tala kan iomeng. Karuk. Eba omela ninimiap ula iot maset atatan makin. Morowa la tale kan tosagaong turuo Poi ang me na uro kimanam meba mavuvuorang teip ga magaulap onim na kimanam ga tabum na ties. Karuk. Tosagaong ga muruo meba ina malagirang.



1 Ioanes 5:11-13

Pa urio ties la baisong Morowa me buun: Morowa irie la okosarong alang buong me ninimiap ula iot maset atatan makin. Ga urio ninimiap la betieng na ubi ang Poi ang Morowa la okosarong bo maiogun. Teip ga magaulap la nenanemela ga Poi ang Morowa, mirie la memaning urio ninimiap. Teip ga magaulap la tale nenanemela ga Poi ang Morowa, tale memaning urio ninimiap. Tie, mamirtung miruo tiesiap me miun la mime nagan iro bonim a Poi ang Morowa, are ratmat meba kan mira, miarora ninimiap la maset iot busit.



Ioanes 14; 2 Korin 5; Mavaik 4, 21, 22

Storyline by: Edward D. Hughes

Illustrated by: Lazarus
and Alastair Paterson

Adapted by: Sarah S.

Kuot NT (kto) © 2001, Wycliffe Bible Translators, Inc.
All rights reserved.

<https://live.bible.is/bible/KTOWBT/MAT/1>

©2026 Bible for Children, Inc.

www.M1914.org

www.bibleforchildren.org

