

# Jon 14

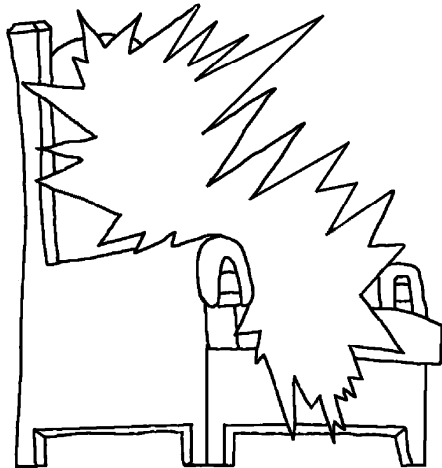

E Iesu i atai la mange, "Gong mulo nuknuk kol. Mulor tortorot o e God, pa mulor tortorot otleng hok. Ting na rumai ane Tata, a galis a rum. Ning bel, ar atai mulo otleng ono. Ar han sur ar sang tar a pukna sur mulo. Ning ia ka sang tar a pukna sur mulo, ar ulak, pa ar ben pas mulo tetek iau, sur mulo otleng mulor kes ting na

hanua ning ar kes ia."



1

Iau e Jon, a tasimulo pa a halimulo ning dala tur taum o e Iesu ana kankan, pa ana nuna matanitu pa a tuntunur rakra kai ning dala kilang a kankan. A kes na dodot tumo na lolo Patimos, anasa a warawai ana warwara

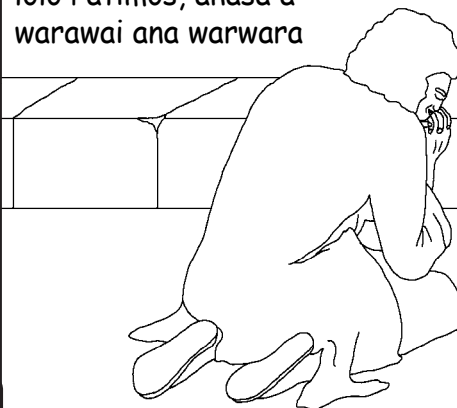

ane God, pa a warwara talapor ane Iesu.

2

Ono otning a bukus ana Talngan Tabu. Pa salanigo tak, a oroi a keskes na king saot na langit, pa takai i kes tar ono.

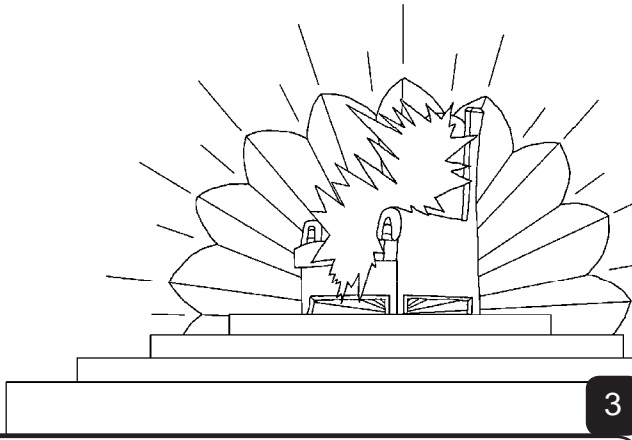

Pa a longor na elngen na akakes rop saot na langit pa te na rakrakan hanua pa tingui na piu pa tingui na puka tasi, a ututnala rop ning di akes la, la saksak larne, "Tetek esaning i kes ana keskes a king, pa tetek a Nat a Sipsip, dalar atong aitna pas diau, dalar hanrawai diau pa dalar aitna pas diau. Pa diar tong akes a rakrakai, bel ir rop pa bel ir rop."

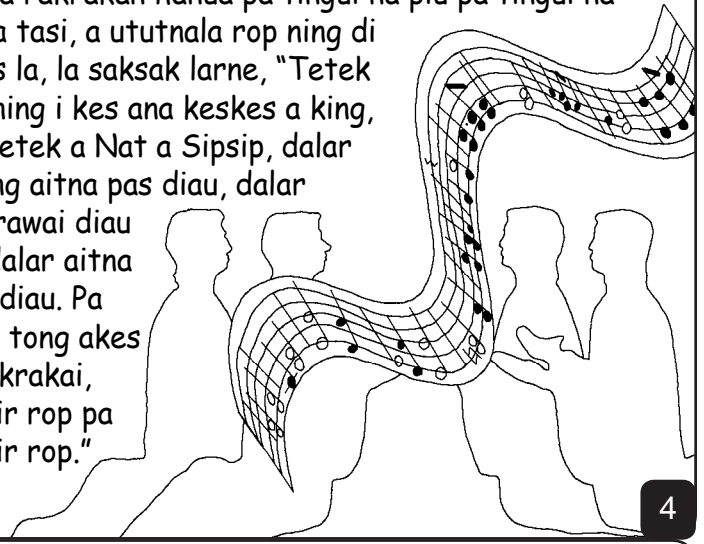

Pa oroi a tona Jerusalem, a hanua ane God, i han purum misaot na langit kusun e God. Di ka sang tari larning di ka amermer wakak tar a hane sur anuna barsan sur diar taulai. Pa a longor a tnan elngen takai misaot ana keskes a king i atongi mang, "Oroi, a hanua ane God ka kes taum ona tarai. I ot ir kes taum on la, pa lar hanot anuna tarai. E God ir kes taum on la, pa ir hanot anunla God."

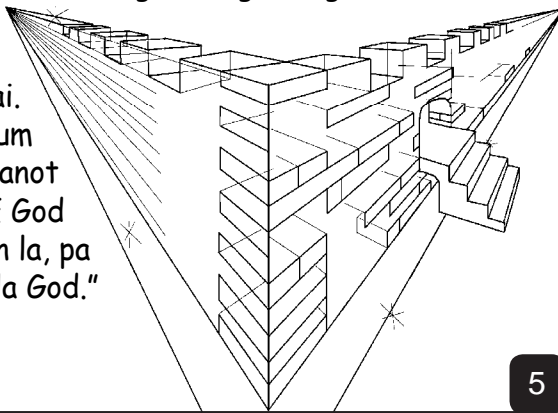

Lamur a angelo i asangan iau a malum a lalaun, ning i talapor arlar ana galas. I saler ot miting na keskes a king ane God, anundiau taum ana Nat a Sipsip.

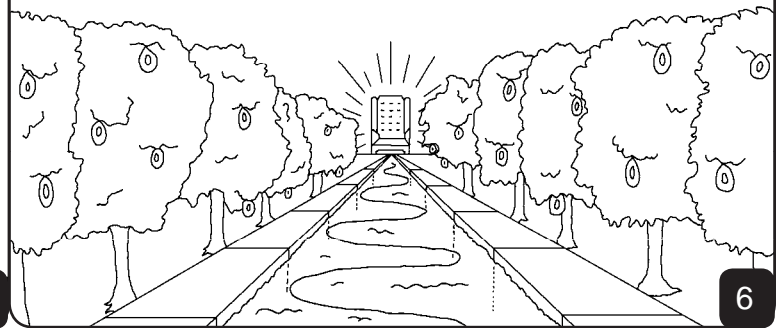

A hanua ning bel i kapan sur a kamis pa a kalang diar atalapori, anasa a matatar ane God ot i atalapori, pa Nat a Sipsip i ot, a lam onoi.

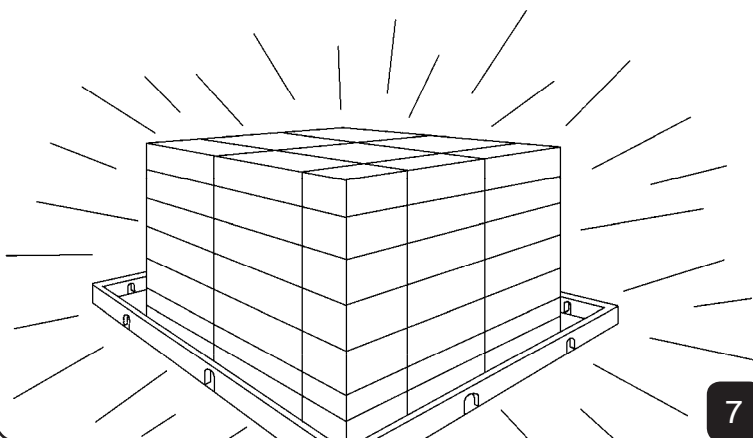

Bel ta dur a utna ir kas tingui na hanua ning, pa bel tik ning i sira tol a ututnala na meme pa bel tik otleng ning i sira asasongo. La ka, ning di ka tumus tar a risanla ting na buk a lalaun ana Nat a Sipsip lar kas.

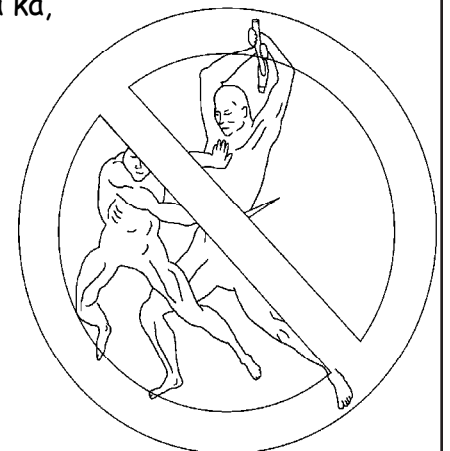

"Pa ir sah sen a luru matanla rop. Bel ta minat ulak ma, bel ta bal maris, bel ta tinangis pa bel ta kankan ma, anasa a ututnala tagun nating la ka rorom."



9

A laulau a ututnala ning a balakut ane God i kes ono, bel ulak ma dir oroi tari. A keskes a king ane God pa anuna Nat a Sipsip ir kes ting na hanua ning, pa na tena titol oros otleng ane God lar lotu teteki. Lar oroi a patarna, pa dir tumus tar a risana ting na patarinla.



10

Pa oroi a minatla rop, la ning la lekkek pa la ning bel al risanla, ning la tur tar salanigo na keskes a king, pa di sapang a bukla. Di sapang ulak ning a buk, a buk a lalaun. Pa di warkurai a minatla arlar ana anunla a titolla ning di ka tumus akes tari ting na bukla. Pa la ning bel di tumus akes na risanla ting na buk a lalaun, di minggen purum sen la uting na tnan tung a iah.

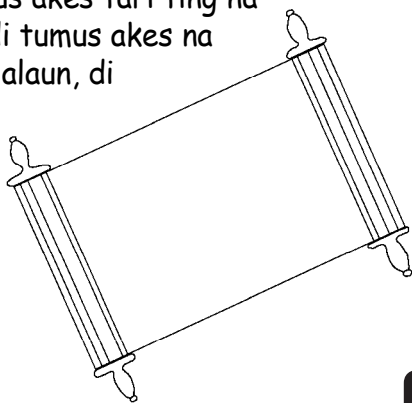

11

A Talngan Tabu pa tona tinaulai, a hane, dia atongi mang, "Han ute!" Pa esining i longori, i otleng ir mang, "Han ute!" Esining i mos, i wakak sur ir han ute, pa esining i mang suri, ir gang a malum a lalaun ning bel di sira lou i.



12

E God i maris a rakrakan hanua, pa i saran tar e Natnalik takai sot ka, sur esining ir tortorot onoi, ir laun tikin, pa bel ir hirua.

Rom 3:23  
Anasa a taraila rop la ka tol tar a toltol laulau, pa la ka kes bakbak kusun a matatar ane God.

Rom 6:23  
Anasa a arlou ana toltol laulau a minat. Ika a artabar ane God a lalaun tikin o e Karisito Iesu anundala Lekkek.

Hibru 9:27  
A taraila rop lar mat muntakai ka, pa lamur lar tur ana warkurai ane God.

Epeses 2:8,9

E God i maris mulo pa i alaun pas mulo ning mulo tortorot. Bel mulo ot mulo kamkamna onoi, a artabar ka ane God tetek mulo. Bel i alaun pas mulo kamkamna ana wakak a titolla ning mulo toli, sakana tik ir aitna pas i ot ono.

Rom 10:9,10

Ning u apuasa i ana numa warwara mang e Iesu a Leklek, pa u tortorot ting na balam mang e God ka akamtur ulak pasi kusun a minat, e God ir alaun u. E God i atong u mang u tostos namatana anasa u tortorot ting na balam. Pa ir alaun u anasa u apuasa i ana numa warwara mang e Iesu a Leklek.

15

Jon 3:16,17

E God i maris a rakrakan hanua, pa i saran tar e Natnalik takai sot ka, sur esining ir tortorot onoi, ir laun tikin, pa bel ir hirua. E God bel i sune e Natnalik ute ana rakrakan hanua sur ir warkurai a ginina taraila sur lar mat. I sune i sur ir alaun la.

1 Jon 5:11-1

Anuna warwara talapor i mange: E God ka saran tar a lalaun tikin tetek dala, pa a lalaun ning, kaning o e Natnalik. Esining a Nat e God i laun onoi, ka kibas a lalaun. Pa esining a Nat e God bel i laun onoi, bel i kibas a lalaun. A tumus a ututnala ne tetek mulo, ning mulo tortorot ana risana e Nat e God, sur mulor tasmani mang mulo ka kibas a lalaun tikin.

16

Jon 14; 2 Korin 5; Tatatai 4, 21, 22

Storyline by: Edward D. Hughes

Illustrated by: Lazarus, Alastair Paterson

Adapted by: Sarah S.

Label NT (Ibb) © 2019, Wycliffe Bible Translators, Inc.  
All rights reserved.

<https://www.bible.com/bible/1396/MAT.1>

©2026 Bible for Children, Inc.

[www.M1914.org](http://www.M1914.org)    [www.bibleforchildren.org](http://www.bibleforchildren.org)

17