

Baibulo na anamwani Wovelhelha



Ohdhulu
Owani wa
Mulukuh



Wolembiwa ni: Edward Hughes
Umothonyeha ni: Lazarus; Alastair P.
Omukusa ni: Sarah S.
Wotaphuhela ni: John Kaliwo
Wokumiha ni: Bible for Children
www.M1914.org

BFC
PO Box 3
Winnipeg, MB R3C 2G1
Canada

©2021 Bible for Children, Inc.
Liasense: Nywoo mokalano ehaki yokusha ni oluwela
sohimuwa seya wohimphakela nakoso.



Vamene Yesu wari mu elapo ya
vathi wakalotaka ni ohudhera
aya za odhulu. Mdhina aye
"Nyumba ya atithinya"
walotakatho akhalamo
malo anchichi.
Odhulu ni wokongola
wovambalna elapo ya
vathi.



Yesu waotaka "kinorokukunzera malo odhulu.
Kavilak kinorowa kukuwakhelani mwaine mekhame.
Yesu wavira odhulu wakhumaka m'mahame. Vamene
ohudhelaya aya awehaka, Yesu wakusiwawovira
miramboni
ohudhelawo
naweha.

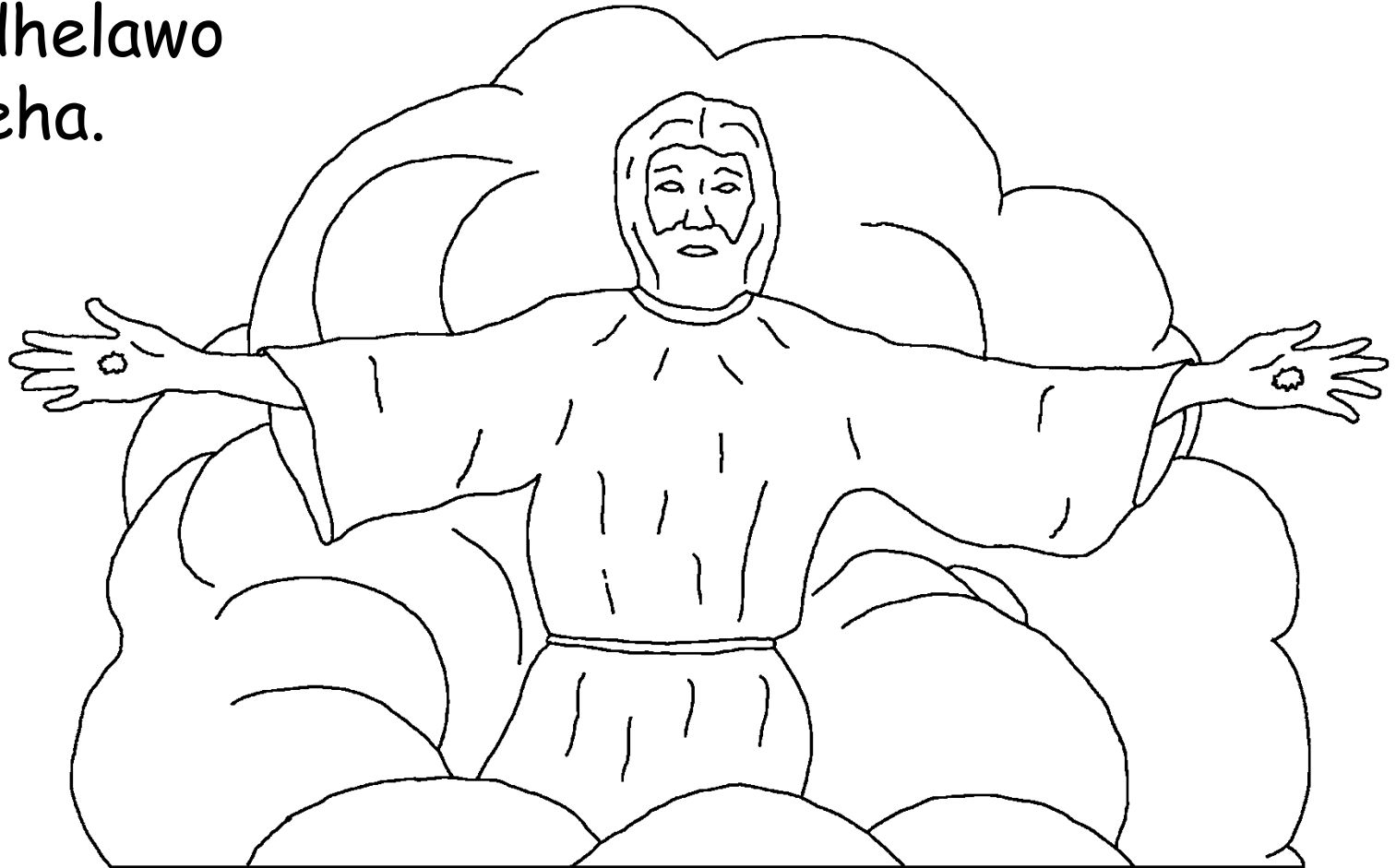

Ohambilah vavo a Khrisitu anawupuwelha Yesu
wolonjeza anorowa owakusa aye. Yesu walotaka
anorowa mozizimusa. Chinorochitikaka
ni tini kwa a khristu akhwa Yesu
wahiweke? Baibulu linimalota
kuti anorokhala ni Yesu.
Wahikhalawo mu
thupiri, ni
wokhalawo
ni Mulukuh.



**OKHALA NI
APHWIYA**



Chuvumbuluso buku lomalihela limalota za
odhulu wororomiha eri. Chithu chororomiha
chili, ni nyumba ya Mulukuh. (odhulu). Mulukuh wari
vanivotheh, koma mvando
aye wokhala
odhulu.

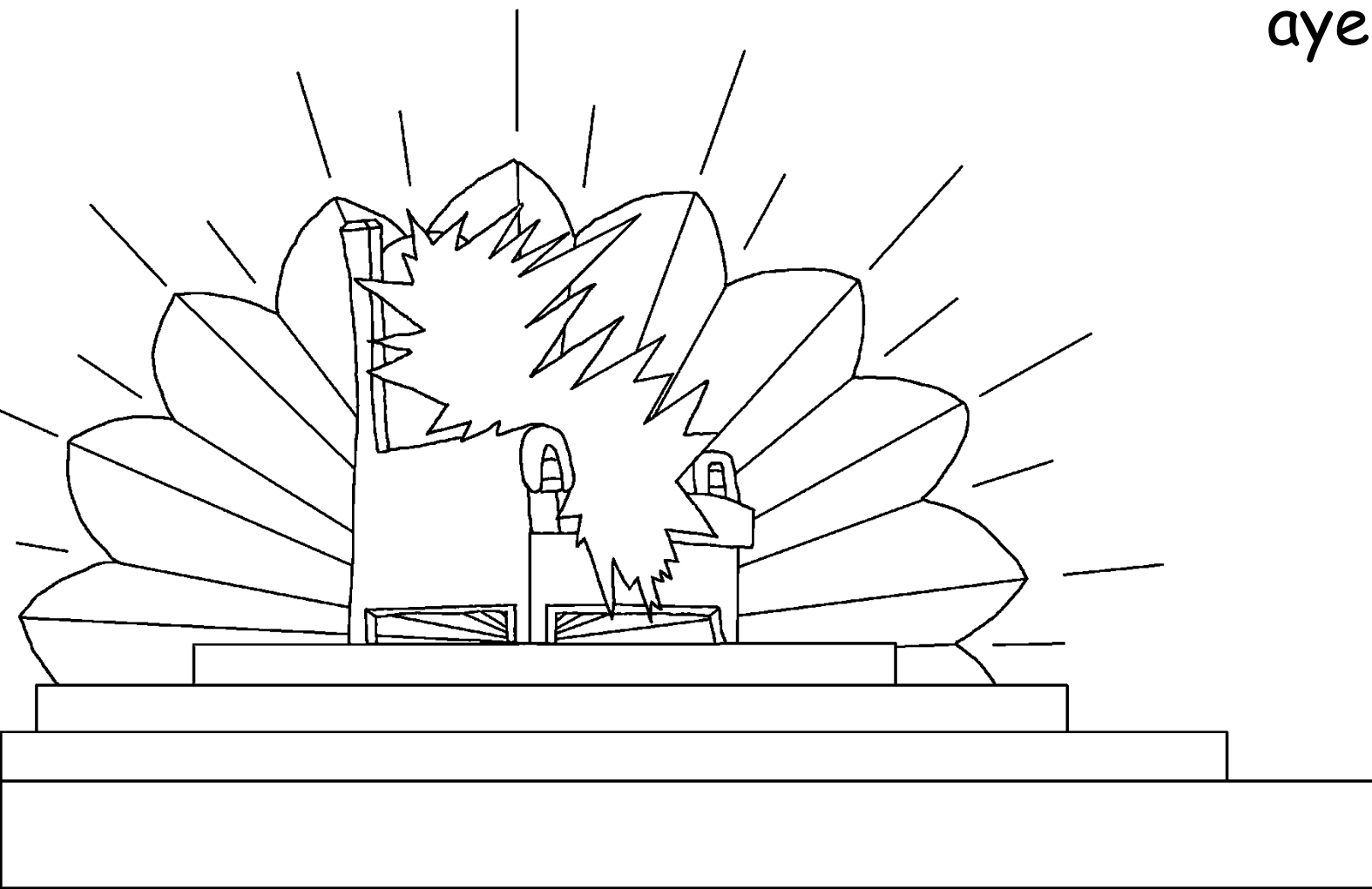

Angelo ni zithu za mu dhulu
zimalambela Mulukuh mahiwu
ni othahna. Ophwanaphwana
ni athu a Mulukuh akhwile
ari odhulu. Ana ipa
nyimbo za phama
omuipelah
Mulukuh.

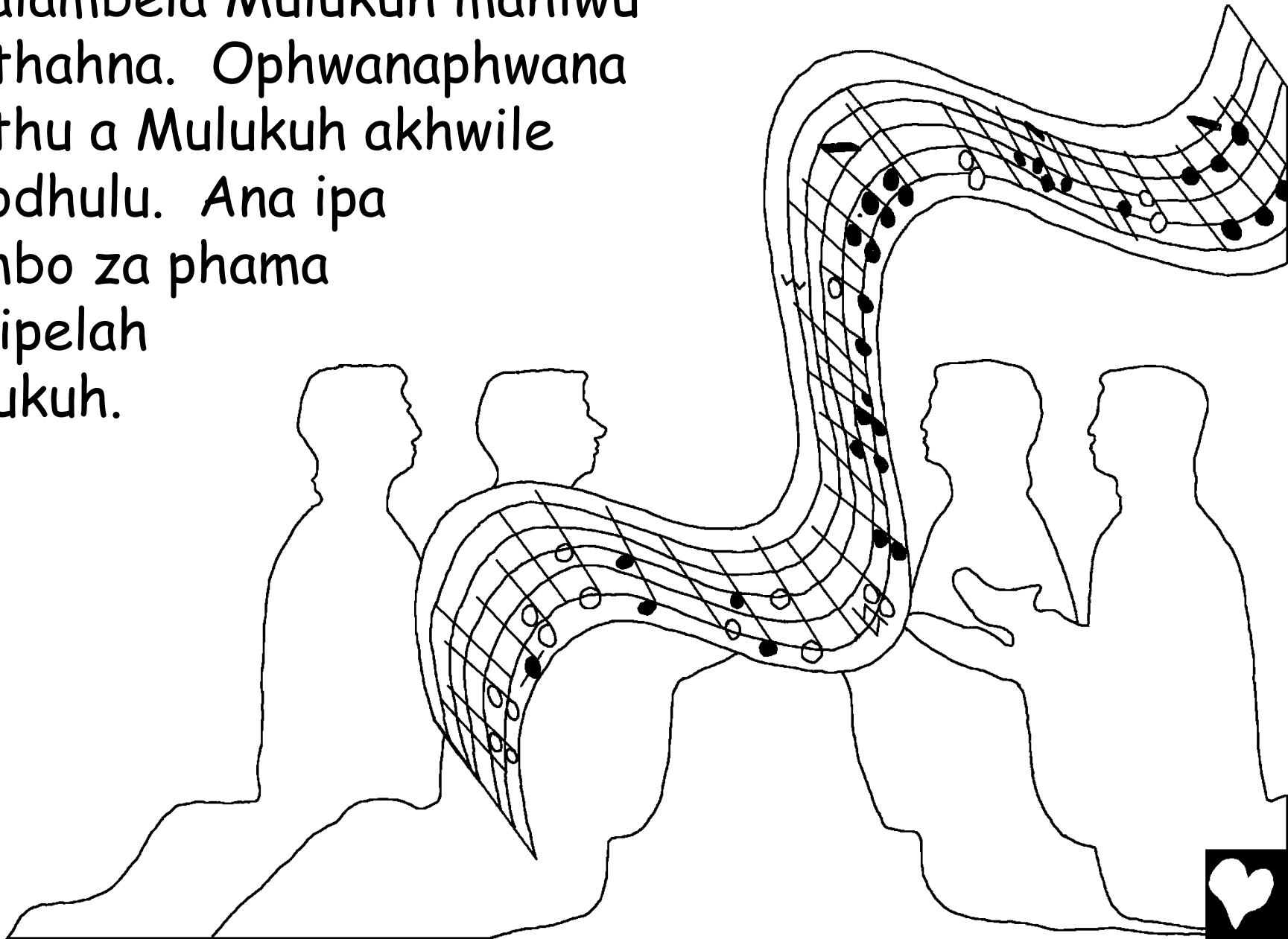

Alha akhala madhu okhala munyimbo zahipiwa
"MWAYENERAH WWWWMWATUKHULILAH
KWA MULUKUH OVENYERA
M'MWAZI WANU MWA
MTUNDU NDI ATHU
MWATIPANGA ANSEMBE
AAKHALAPUYA KWA
MULUKUH
WATHU".
(Chivumbuluso
5:9)

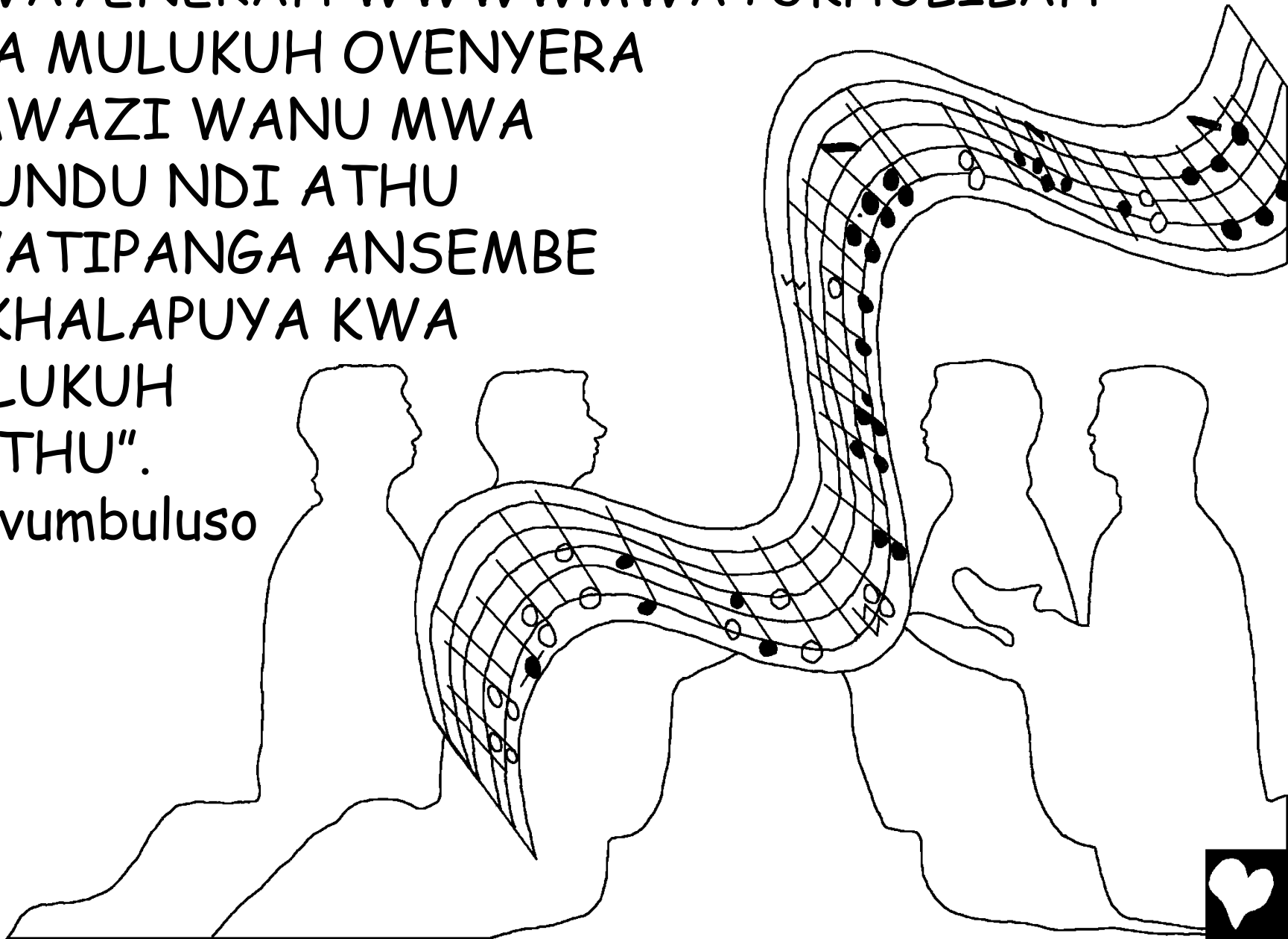

Ethapa lomalihelah nibaibolo linopokosa odhulu ngati
"Yerusalemu wasopano" Ari wouluvalah ni makoma
aye amalukuh ya mutekho winchichi. Malukkuh a
yasipa ni juwelo alihala vathi voyambelela mpanda,
yooneya ni mitundu ya
phama.

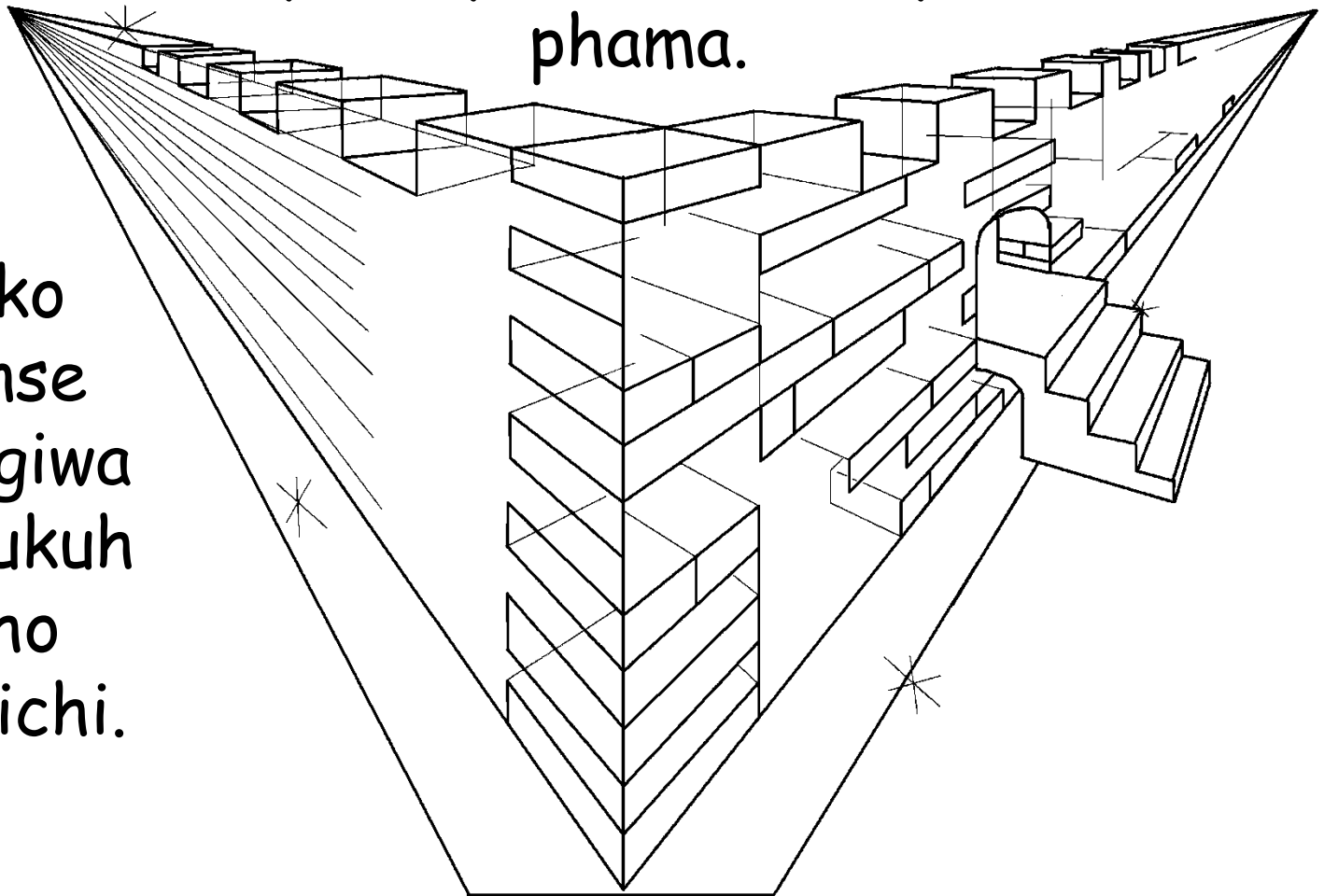

Mulhako
uli wonse
wapangiwa
ni malukuh
a mukho
wanchichi.



Milhako ya Maluku a mukho wa vadhulu yahekiwa.
Tiyeni tivire kaweheke. Odhulu ni wokongola
muwari. Mzinda wamakiwa ni golide. Elilah
yoorowanko iri
yagolide.

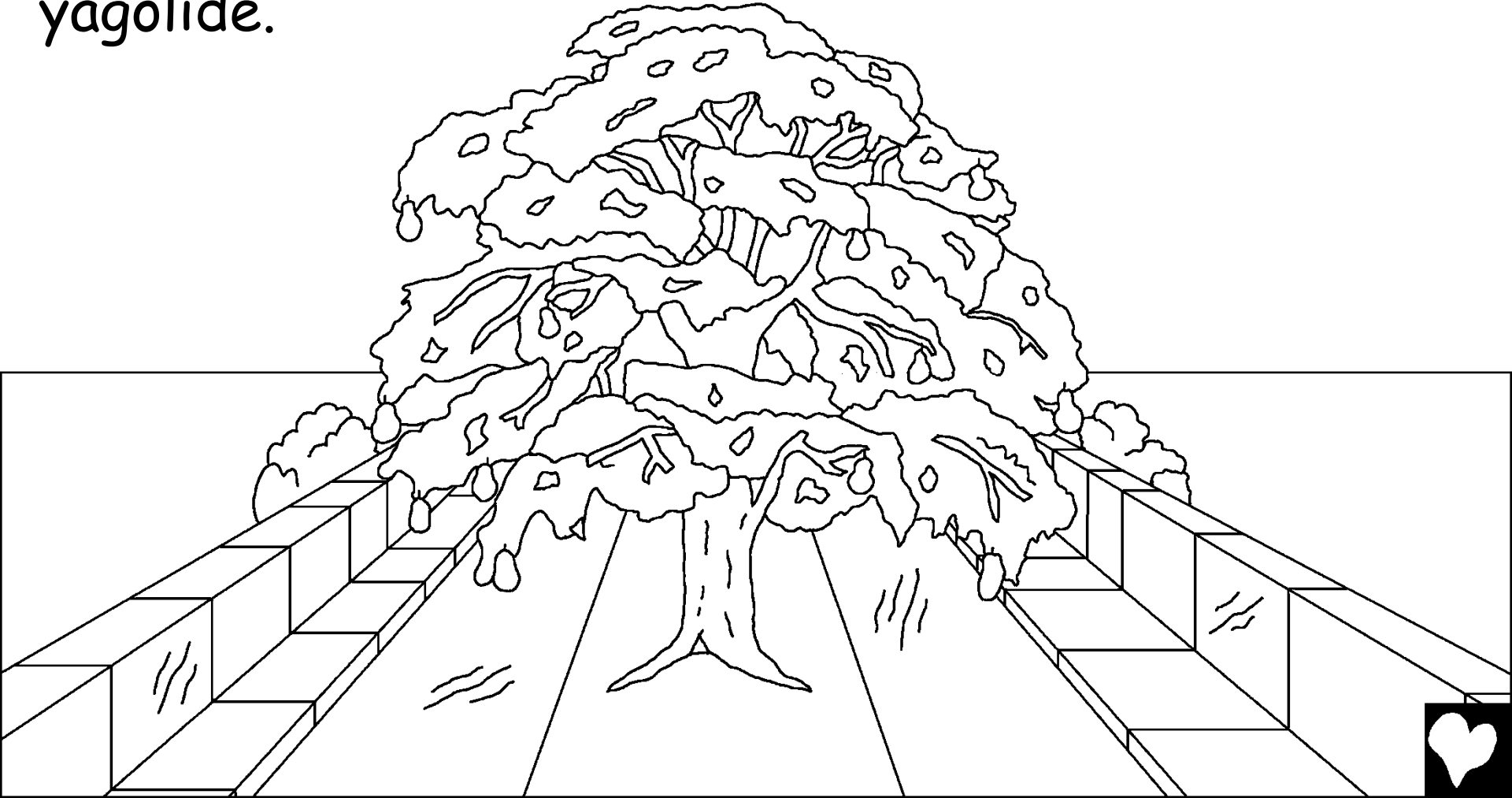

Msinjeni wokongola, madhi a phama okhumela
omupandoni wa Mulukuh. Embali ina ya msinjeni
mutheko wa moyo, ole waphwanywa m'matah mwa
Edeni. Mutekho olah wororomiha. Unayara zipaso
khumi ni piri vohiyannahina mwezi uliwonse.
Mathapaye ari murete wochiliha athu.

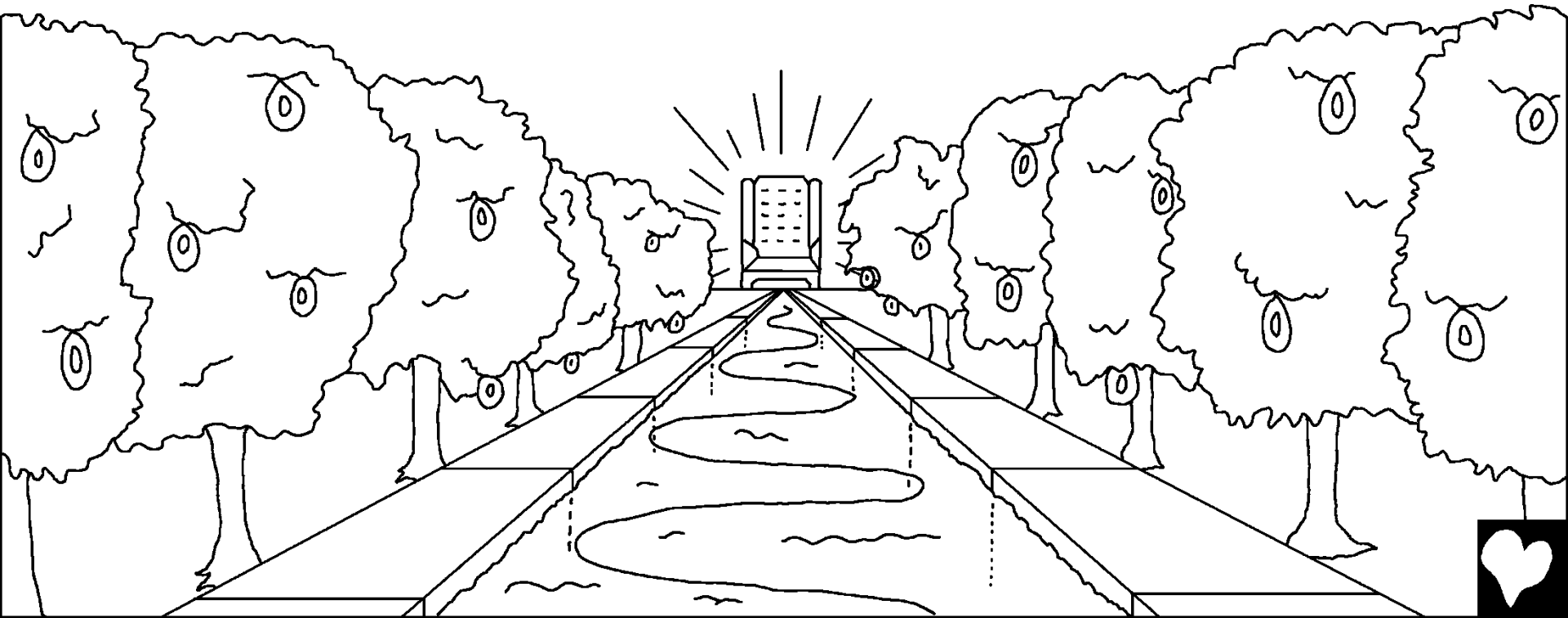

Odhulu khunapala m'dhuwa kapena mwezi kuti uwaliheke. Malukuh ulemelero waye unorowalihera. Mahiwu khaliwo.

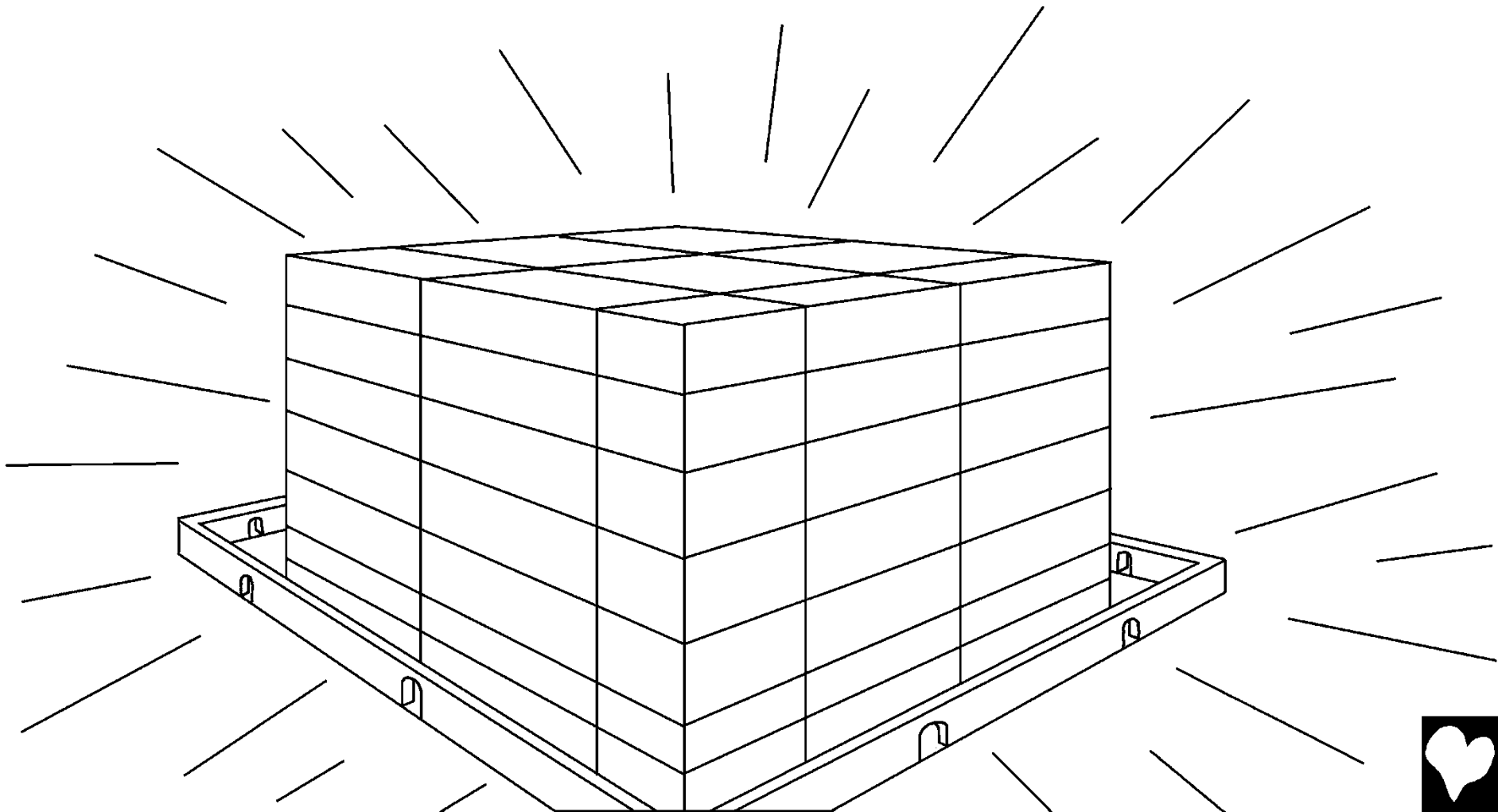

Ngakhale e naama nivihiyana ni za elapo elah.
Zothene zinachela vamomodha. Akathwe ni nkhusa
zinachela vampdha. Mikango yaphavu acha manasi.
Mulukuh walota "Wahikhalah ochona ni mwangoni
mwakamu".

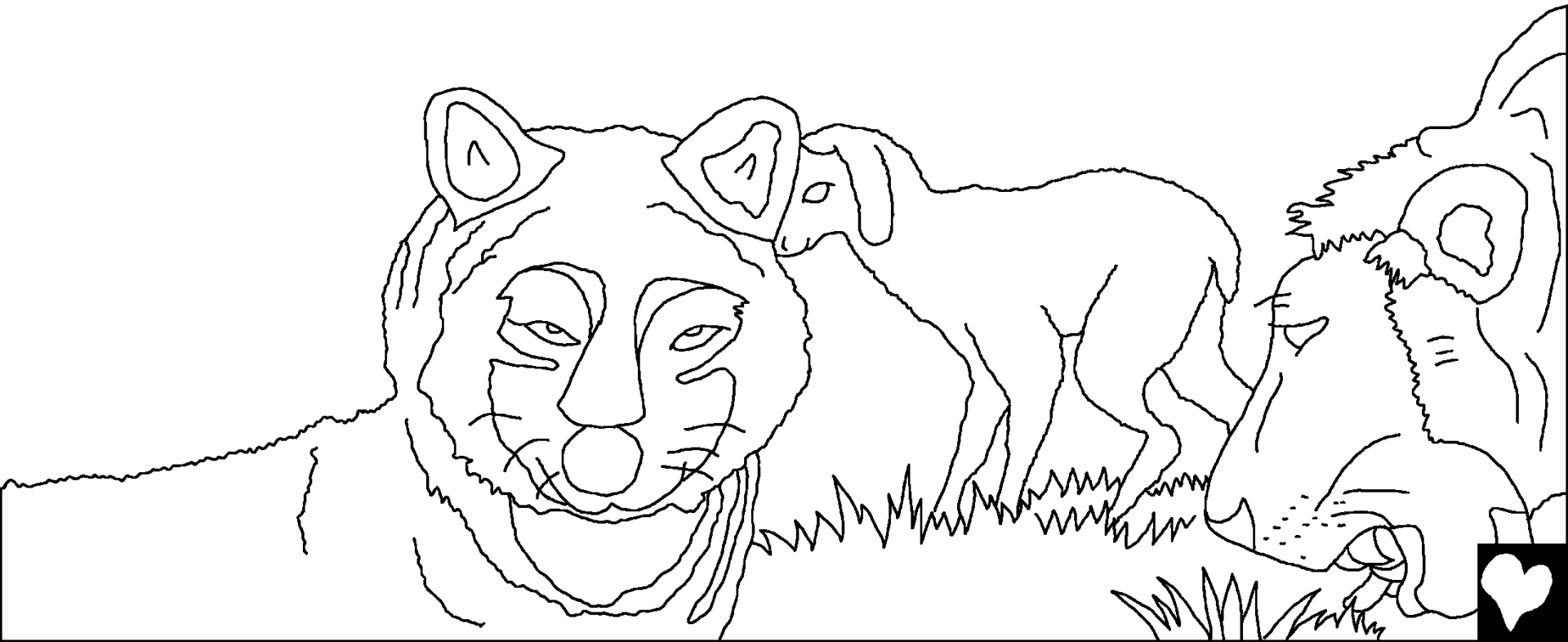

Tikawehaka, tinoroona kuti zithu zanchichi vimene
oduli ziliwo. Madhu aepewe hanaloliwawo. Khaivo
muthu athamaleya,

okakathana
nakhwiwa.

Khaivo
maloko
kambiwa
khaivo
awiya
odhulu.

Khaivo,
oothah,
athu okhwana
ni chimo odhulu.

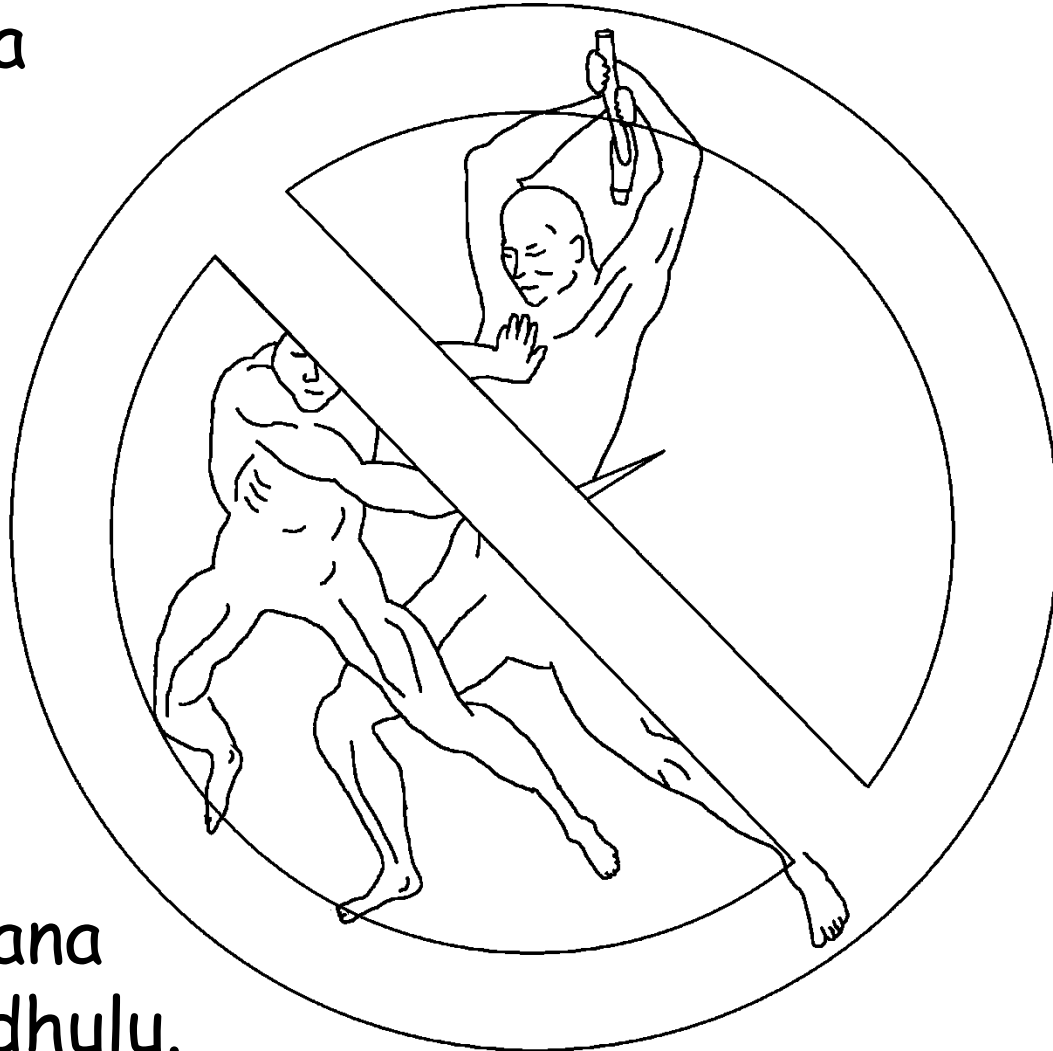

Odhulu ni Mulukh
kwahikhalah wunlah.
Athuh a Mulukuh
akumanana ni maviho.
Odhulu Mulukuh
anoropukuta misozi
yotheneh.



Khaivo imfa odhulu: Athuh a Mulukuh anorohakalala
ni Mulukuh kohamalah. Mavoho khaivo, wunlah
kapena ovoreya. Maliro khaivo.

Muthu aliyense
ali ohakalala
kohamalah
ni Mulukuh.



Odhulu ni athuh othene olopwana athiyana,
anamwani ni oluvaene, akhulupilirah n'dhina la Yesu
mvulumusi ni kumuwela ngali mbuye iwa. Odhuluh
wuri buku n'dhinaye Buku la mwanaye wa nkhosa
Ebuku elah yodhala ni mayina a athuh.

Munadhiwelah athu alembedwa
m'bukumo? Athu othene

wokhulupililha
Yesu Khiristu.

Mdhinamu

Yalembedwamo.

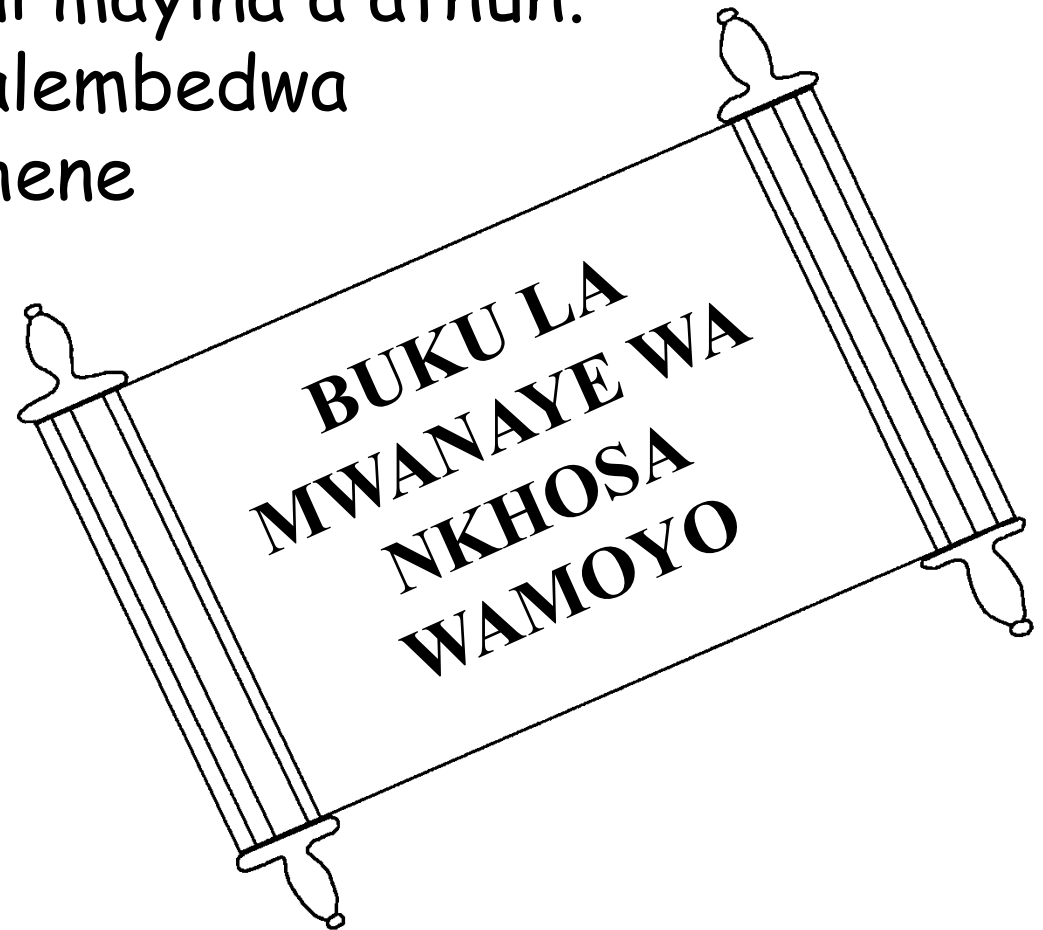

Madhu omalihela a odhulu ari owithana. "Mzimu ni nkhoswe animalota 'wani' Muthu ariyense awahiwa aloteh 'wani'. Ariyense opalha madhi awekewuno. Ni athu othene akhumbelha akuse madhi a moyo wopana ndalama."



Ohdhulu Owani wa Mulukuh

Sohimua iya sa maso a Mulukuh, Baibulo,

emphwanyaneya

John 14;

2 Corinthians 5;

Revelation 4, 21, 22

"Ovolhowa wa mau awinyu anawana ooneya."

Masalimo 119:130



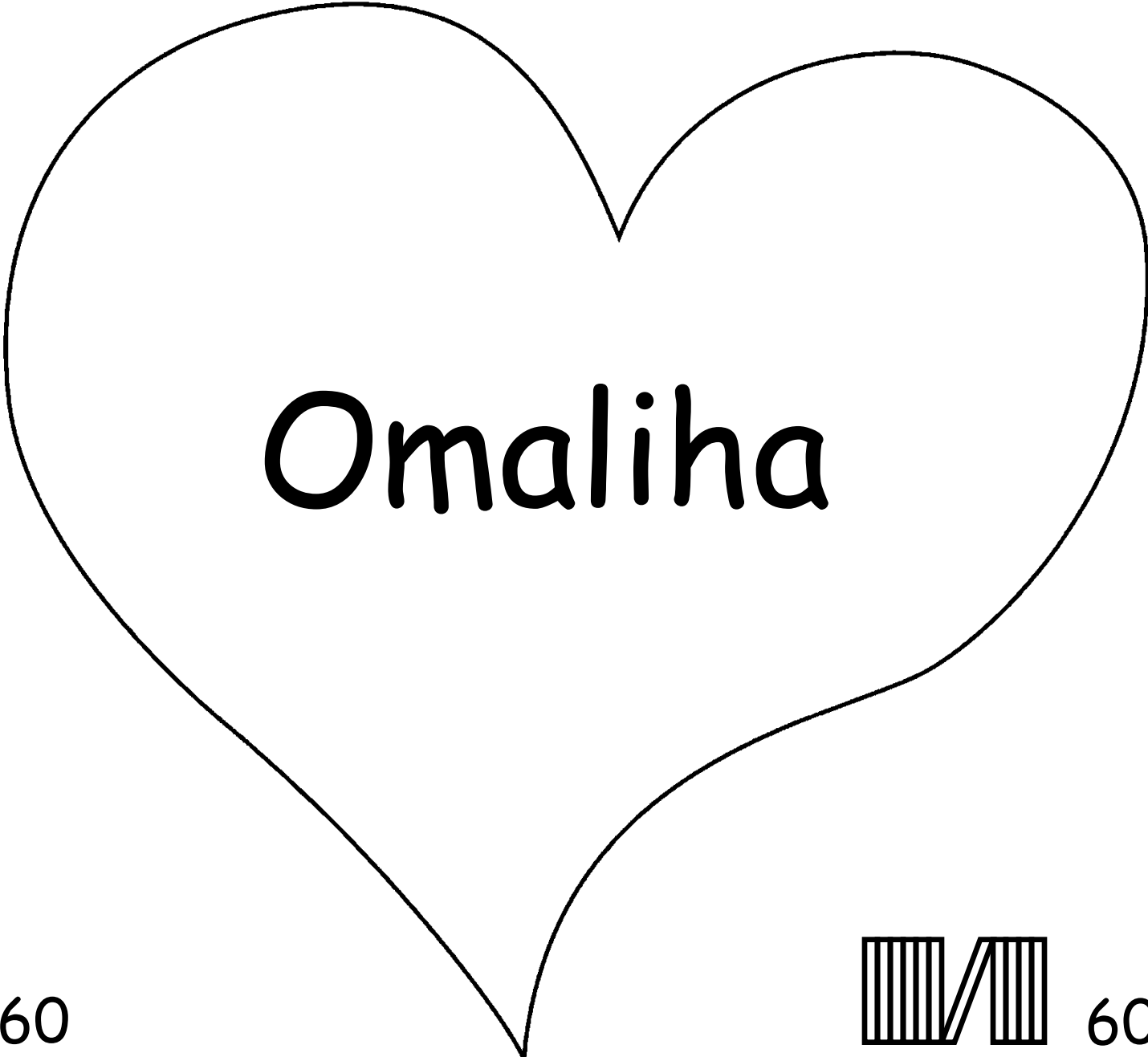

Omaliha

60

60



Masu ala ambaibulo anilela wi Mulukuh
ahu oweriasha onipathunxe onthuna wela nimusueli.

Mulukuh osuela wer la hyo ninapaka itu sotakala, sinitaniwa itampi. Emphwanhaho wasoteka okwa, wayeyo Mulukuh onisiveleliwa ninhuo siso omuluma muwanawe mmosalo, Yesu, wera okwe vamuikimanho ni othipihe sotekasaho. Yesu ahiwa mulaponi ni othikela owanhawe oparaiso. Yuo muamukupali Yesu ni muamvekela wira oleveleleni sothekasanho, yowo onimolevelelani. Yowo onowa okale ninhuo olelo, nyuo munokala niyowo mpaka kalai.

Nyuo muakupali wi eyo ekaikai, mmulele Mulukwaho:
Osiveleya Yesu, miyo kinikupali weran yuwo Mulukuh, muhipanka ntoko mutho wira mukwe muaha wa sothekasaka, vano nyuo muri mukumito. Shonthe, mvolowe muekuminimuaka ni mukilevelele sothekasaka, wira myo kikalane ekumi esa, nihuko nimosi kirowe kikale ninyuo mpakano kalai. Mukikavihere wira ketheleke ni kikaleke wanyuwo ntoko muaninyo. Amem

Musome Baibulo ni mulavule ni Mulukuh
mahiko otene! Yohani 3:16

