

Biblia o nkera Neeu



Shumata,
Engaji Sidai
E nkai



Written by: Edward Hughes

Illustrated by: Lazarus
Alastair Paterson

Adapted by: Sarah S.

Produced by: Bible for Children
www.M1914.org

©2023 Bible for Children, Inc.

License: You have the right to copy or print this story,
as long as you do not sell it.



Iho opa etonita yesu tenakop Negira aaliki
Iwanafunzi lenyena imbaak eshumata neekipoto
aajo "engang'e papa" nejo ore
shumata netii intonat sidan
Naleng'. Iho shumata
Niikitok nelala
aalang'Ingajiji
kituak tenakop.

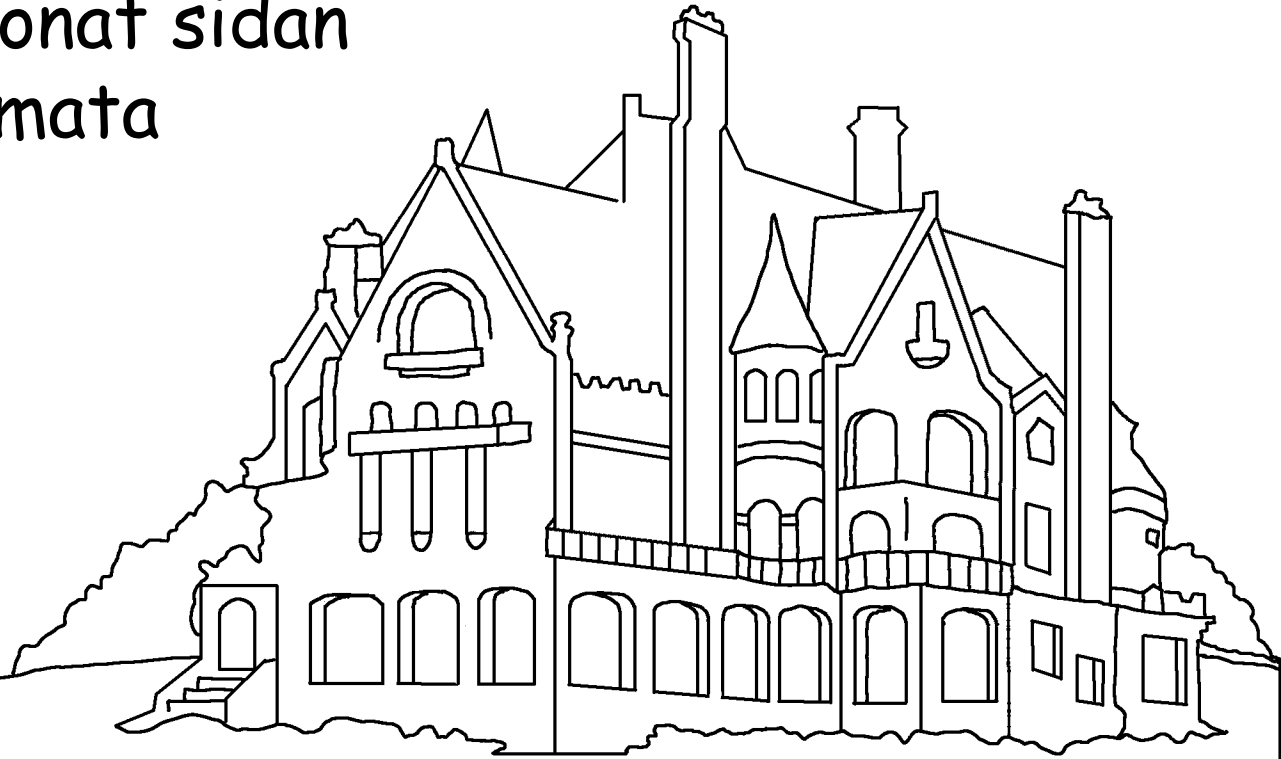

Nejo YESU "aloito nanu aitaboraki intai ewaji tenashumata, kake ashukunye paalotu aarikintai engaji ai". Ehomu opa Yesu shumata etopokwa te ngeeya Iho ing'urita iwanafunzi lenyena nedumu ni YESU ailepye, neep inkatambo peemedoli katareg.

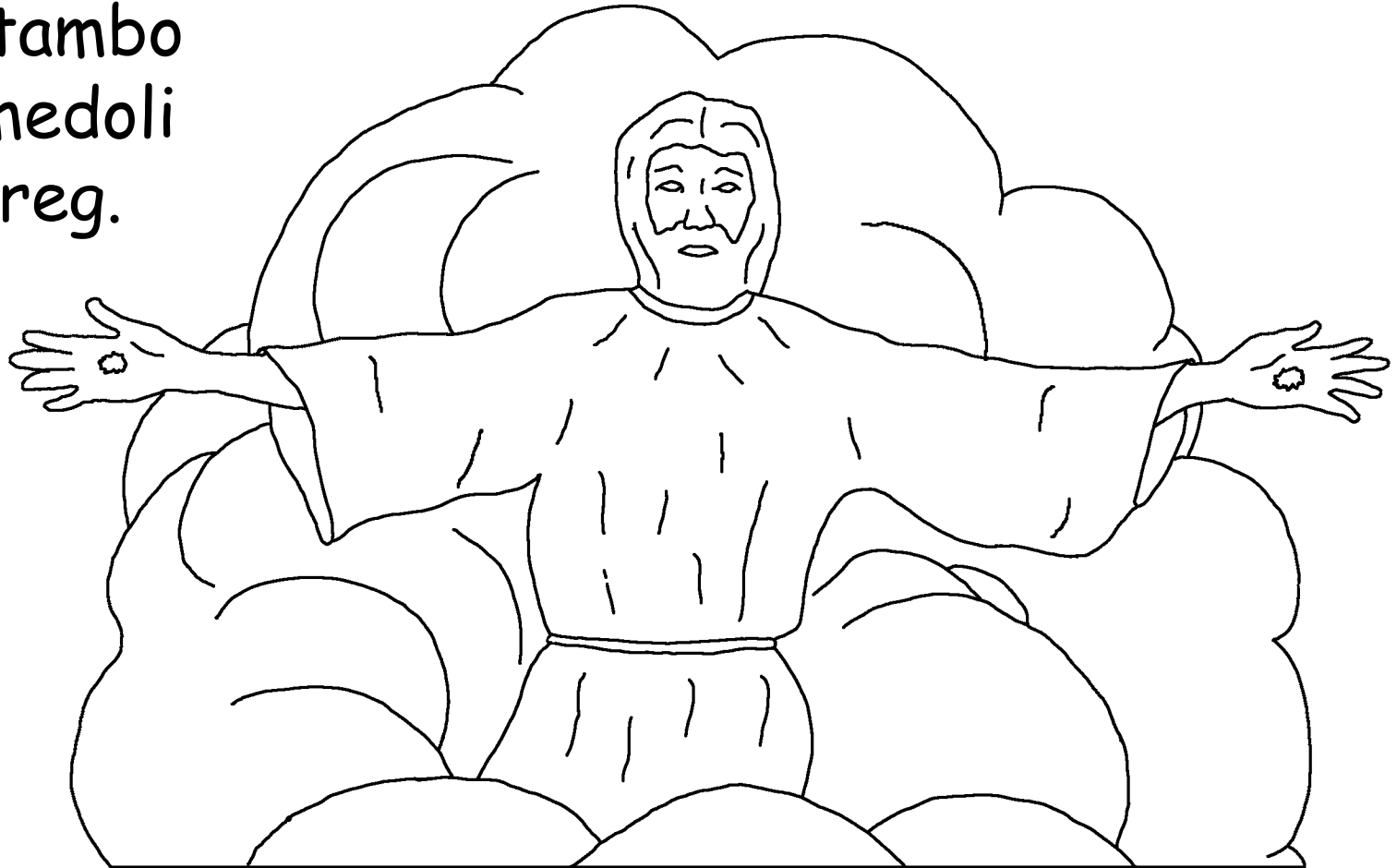

Aitertina neeku edamu likirisiano aajo etojo
opa YESU eshukunye aaya intai. Etejo opa YESU
eshukunye, tengata nemeji inye eshukunye
kake oo irikirisiano loiminie engishui
eton itwelotu YESU? Ejo
biblia ekewo aaboita oo
YESU. Aamu tenemoti
I osesen na YESU
ibotaire.

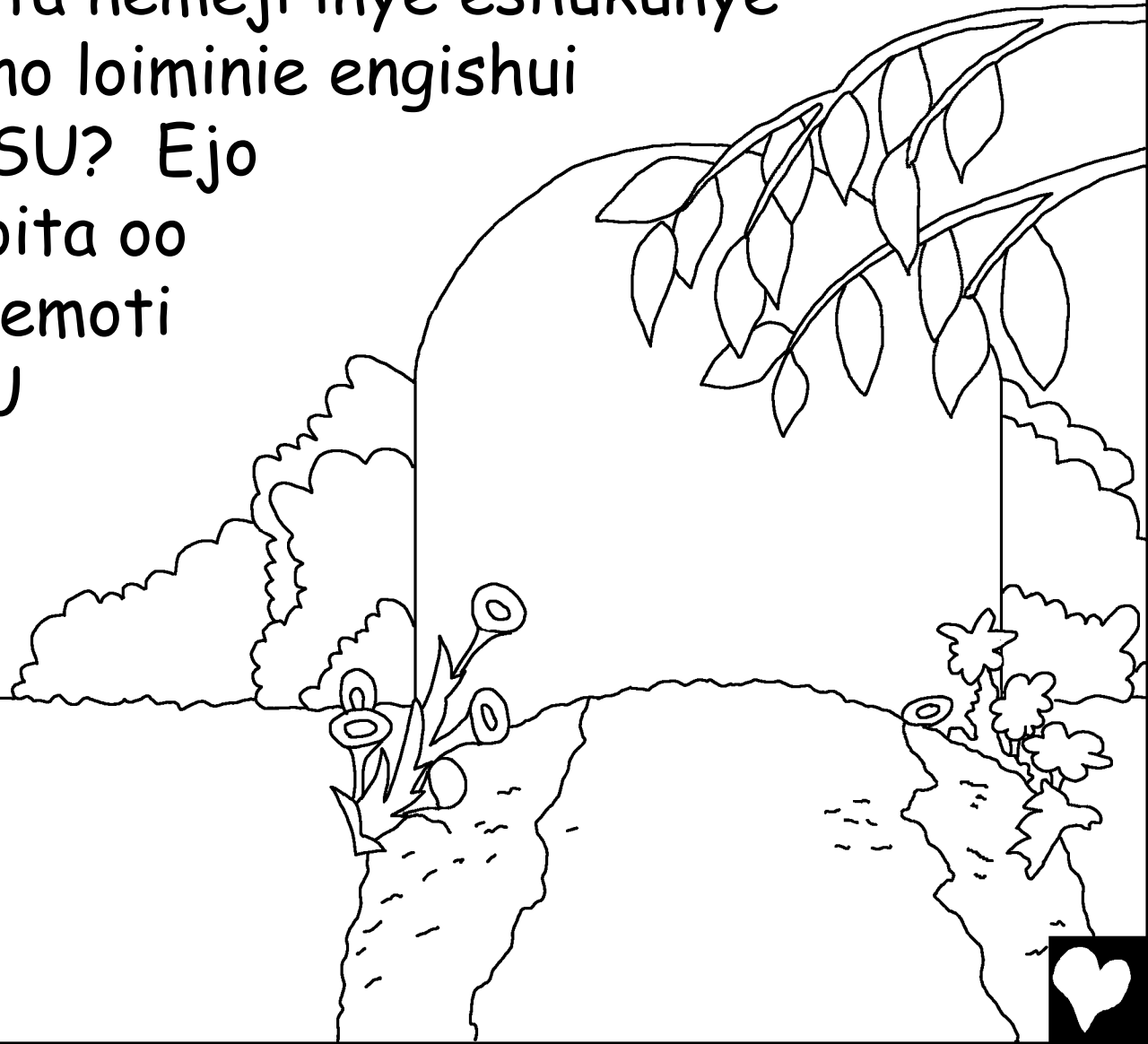

Embolunoto engitabu ee kurum te biblia neliki iyook enging'asya e shumata. Nabo ne nging'asya na engoitoi sidai iho engay na iho shumata na engaji o engai. Na ekitii engai ewoji pookini tenakop kake iho engaji enye na shumata.

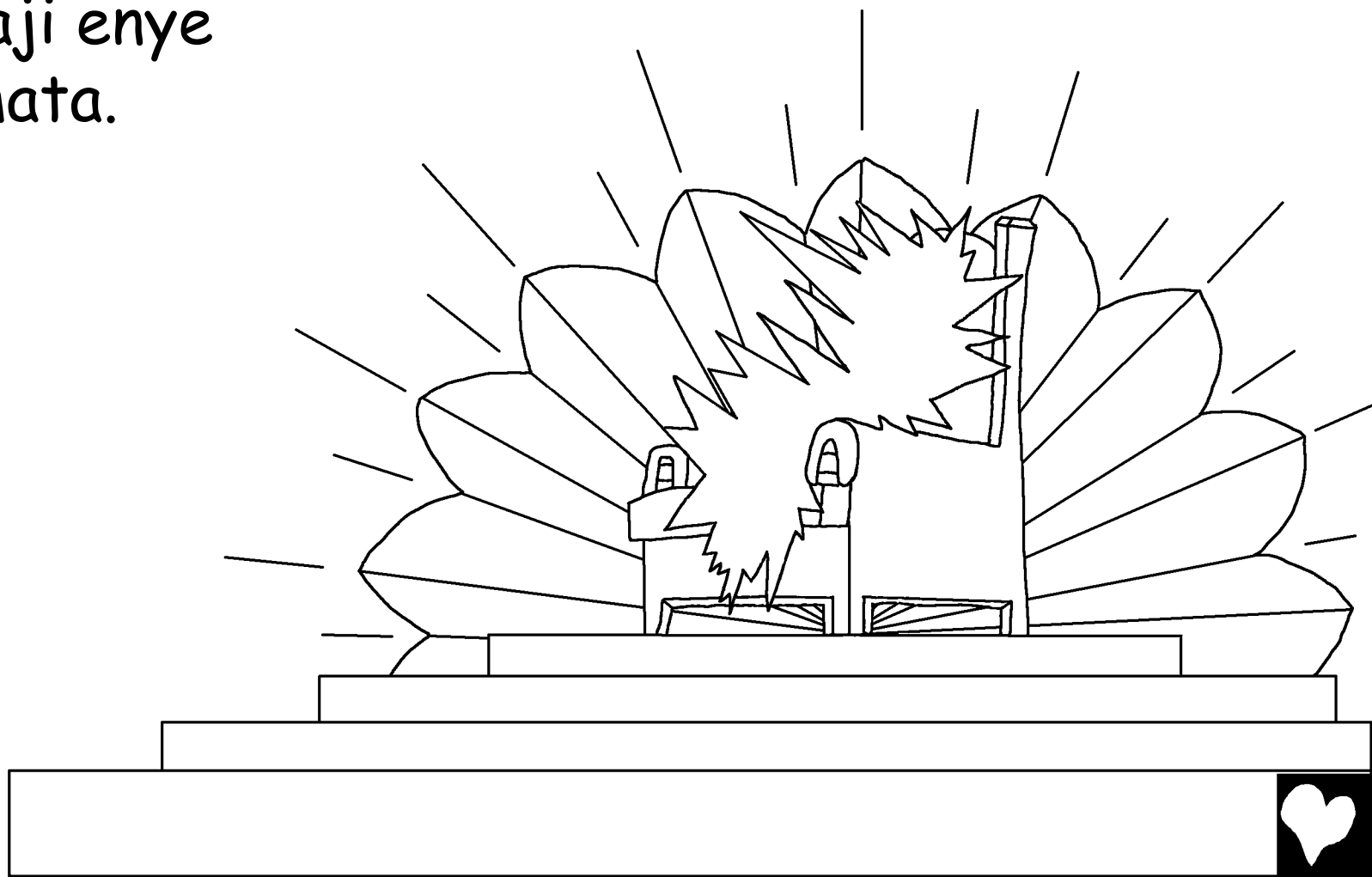

Iho irmalaikani oo ngulien
engishui te shumata neekesaita
engai. Ore ake iltung'ana lengai
loo twata newoshumata
neseremita sininje aarany
isingoloiti lengito o enkai.

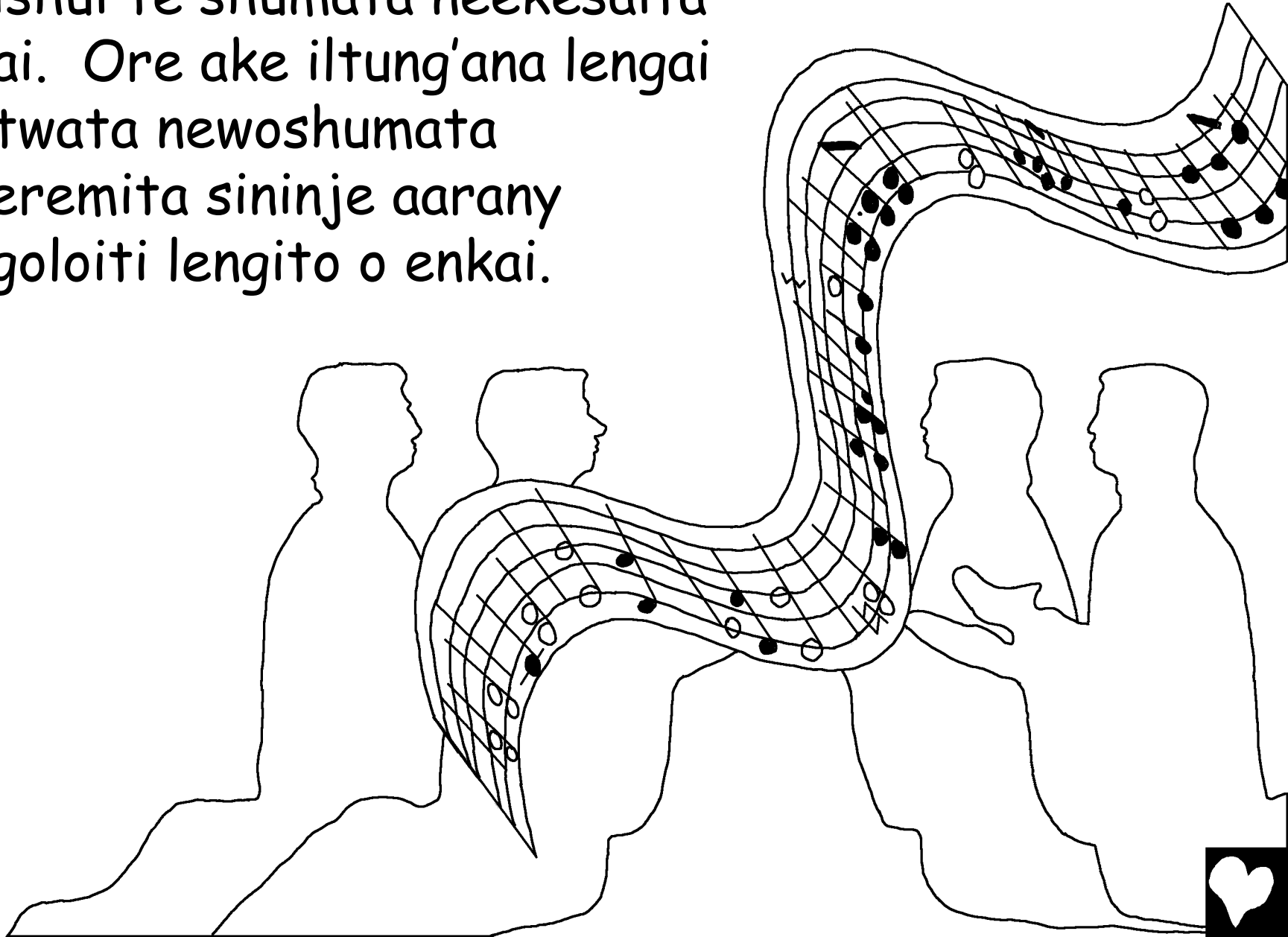

Iho kule na isirat lo singulio loranyiteshumata
"KUNCHIIKINO INYIE PEEIDUMU OLPIYAYATI
LEEMBUKU NIBELILM SHIREN
AMU KITEYENG'AKI
APA NAA TO SARGE LINO
INYIANG'AKA ENKAI
ILTUNG'ANA AITUNG'AA
LOSHON
POOKI O
ING'EJEP A, O
ILTUNG'ANA
O LERERE
(Embolutono
5:9).



Iho isirat lekurum te biblia negira aalimu shumata tanaa "jerusalem ng'eju". Kitok naleng' neeta oikuta leboo o liatwa loitoibiritukul to masaa naibilbil. Iho irmulangoni neitobirakwi te lulu sa puk nalong.

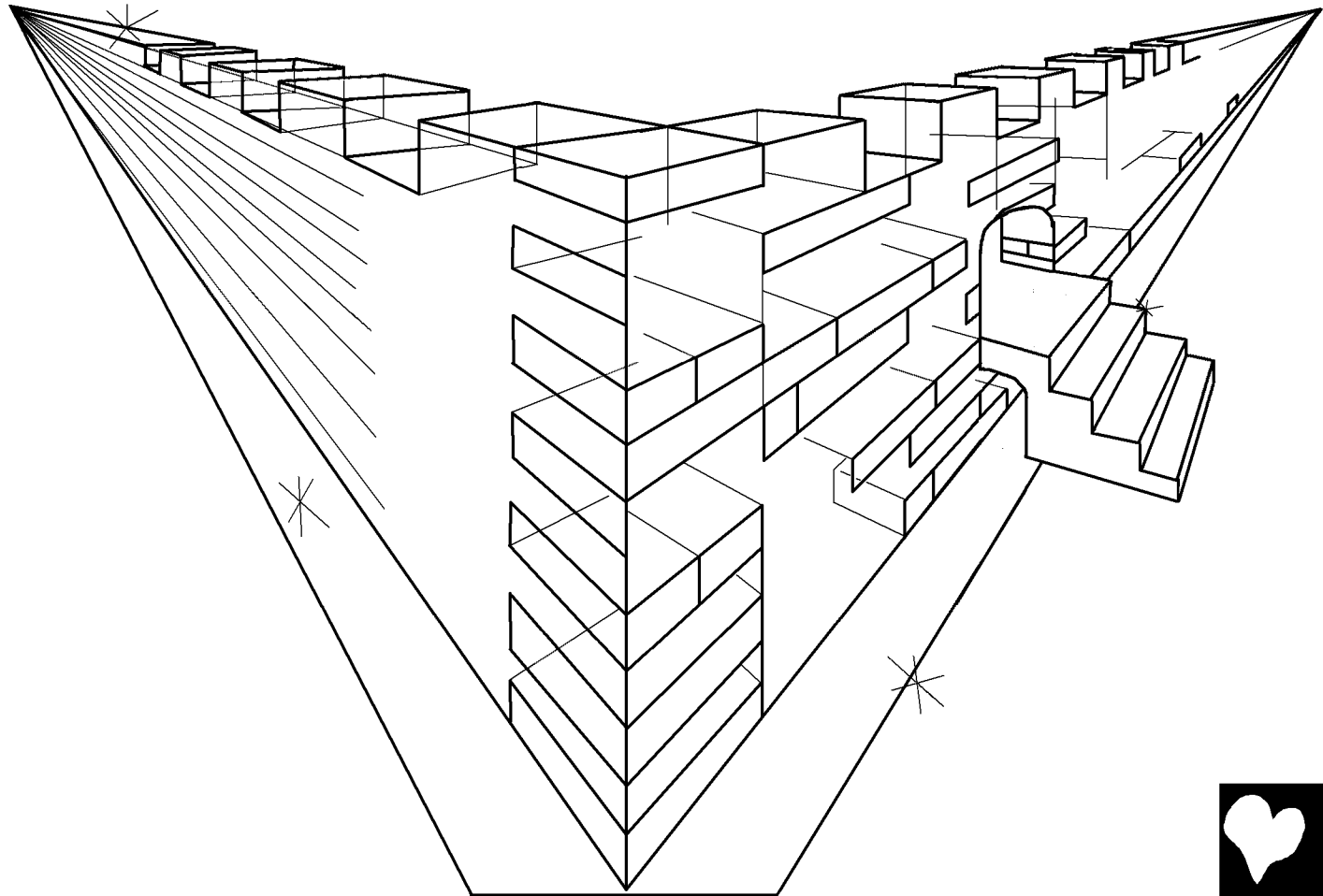

Iyelo irmulangoni loitobirwaki te lulunee kebolo
tengata pookin matijing aatwa peekidol abarakin ...
WAAA iho shumata neekiliiy anag'ainye aataaji.
Iyelo inakop na enkop sidai e sahabu baiki ing'oitoi
ine sahabu ake
sininje.

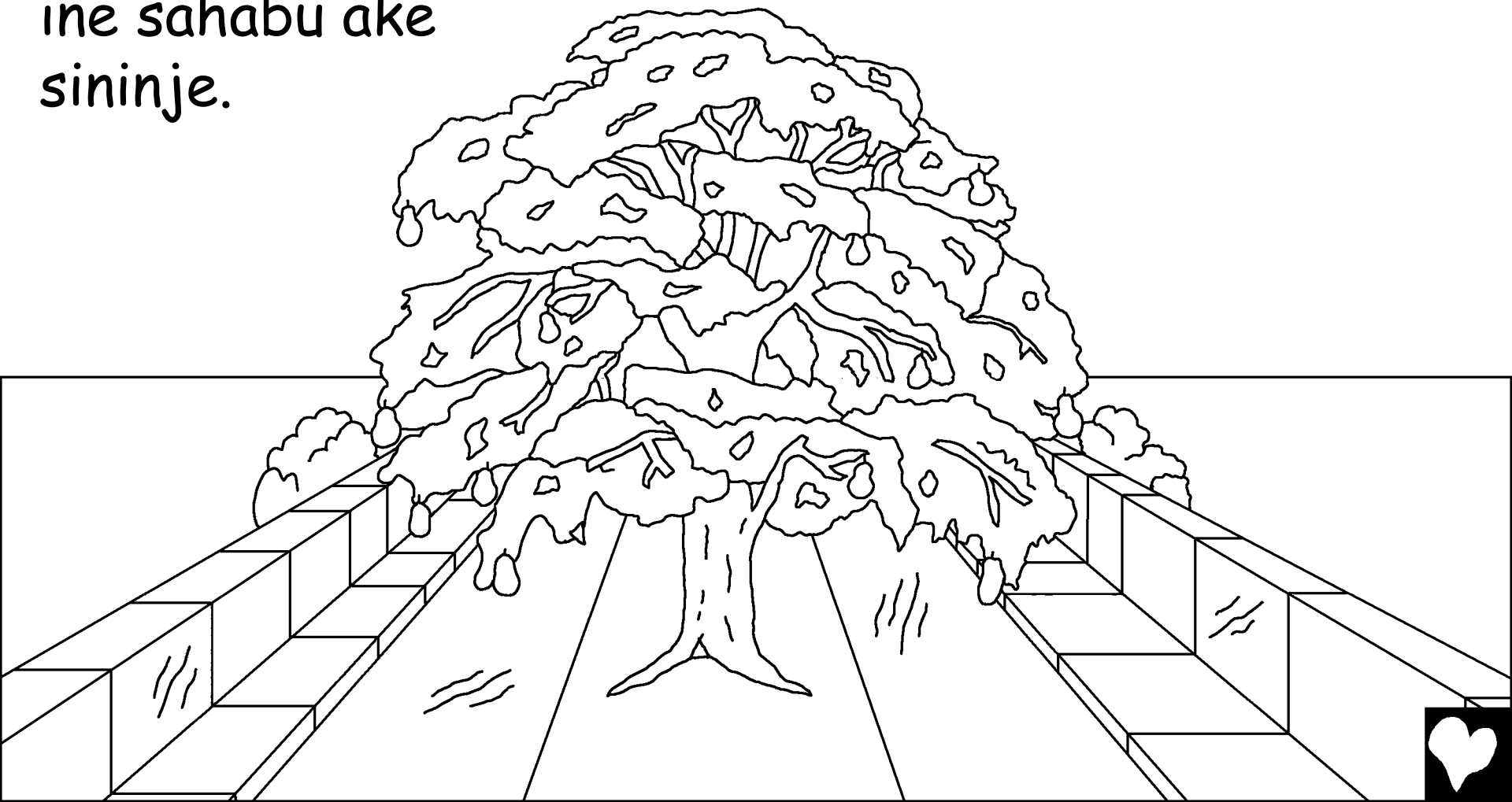

Eketii irkeje sidan le ngare engishui looruko niliil
loopuku to lorika lengitoo enkai. Iho toobat orkeje
netii irchanito sidan lengishui lootii opa aatwa eden.
Iho elehani naa obo ake neitau irmatunda loomwan
torono aare te kila olapa. Neekihor imbala eilohuni
neishiunye ileshori.



Iho shumata meyu engolong' pe olapa enkitoo enkai
naitai eong'an sapuk naleng' Nemetii engewarie
tukul.



Iho ilowarak pookin te shumata na ilomwai kumok.
Na aisupati pookin ildyain onera nekeda pookin.
Baiki orng'atuny neekadaa ongishu. Ekejo enkai
"metum enyamali ne meimin tiatwa oldonyo lai sidai".



Iho kigira aing'uraa nikiyeleu
aajo etii intokiti nemotii
shumata. Metii ilomon
legoro metii iltung'ana
loora au loomit.
Meikenii oweii
teshumata aamu
metii ilaporuk.
Metii ilalaja,
metii ilagoro,
metii ilasakuto.
Metii eng'oki
shumata.



Metii engilio shumata
iyolo ohi eihir iltung'ana
lenkai terbaaye lo sina
sapuk le ngishui tenakop.
Ekijit iyook enkai irkiyoo
te shumata.



Metii engeeya shumata eketeni iltung'ana lenkai
intarasi. Meeku etii osina o emion meeku etii
imoyaritin o enkipung'ot tukul eketon oltung'ani
tenchipay o enkai.



Penareu duo tukul iho shumata eno ndoyok or layok
(o iltung'ana kituak) lootang'amatwa YESU peepik
enganyit tanaa enkai enye. Etii shumata embuku
naji "Embuku engishui" enabore ingarin oltung'ana
kamaa iyelo aajo ingarin oltung'ana
kamaa, iyelo aajo ingarin
oakwa tung'ana
loosira?

Iltung'ana
lootipika osiligi
lenye aatwa YESU
ketii engarna ino?

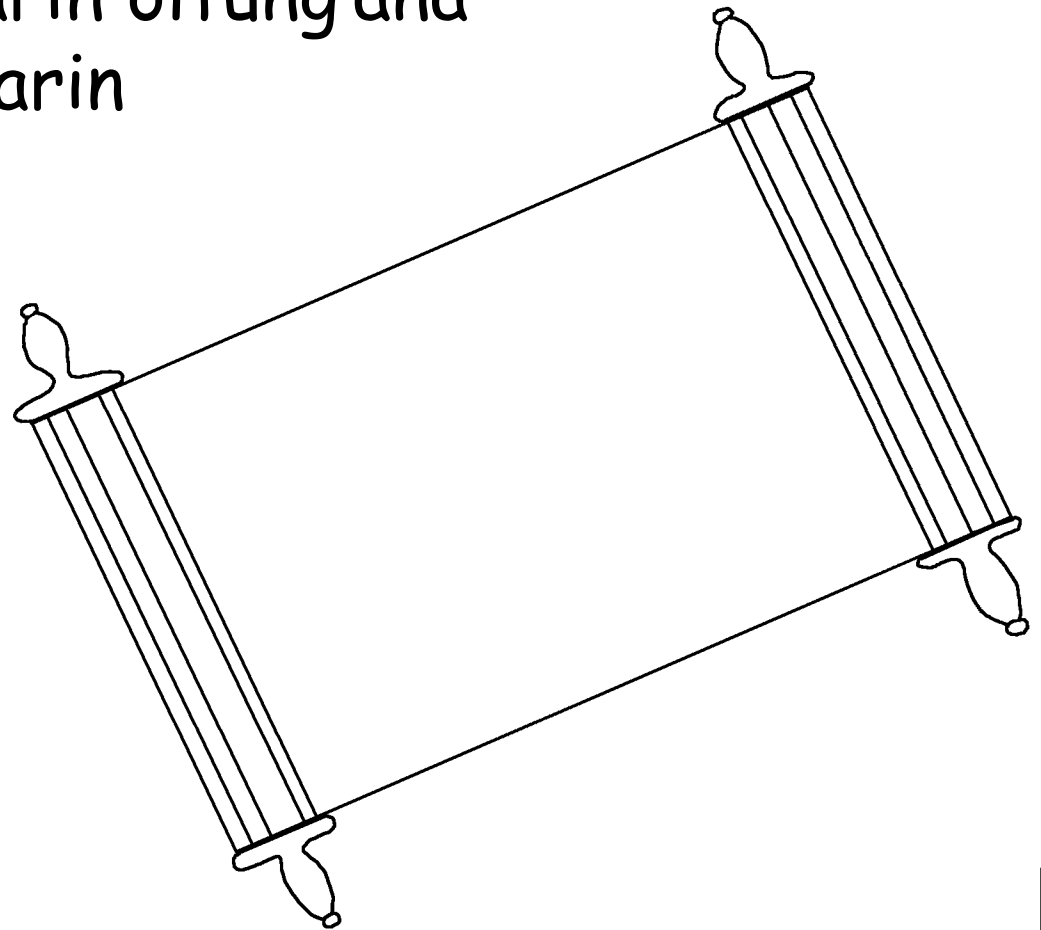

Iho isirat lokurum te biblia neeta ukaribisha.
"Ejo oltau wou" Iho oloota engure nolotu peetum
engare enkishui pono.

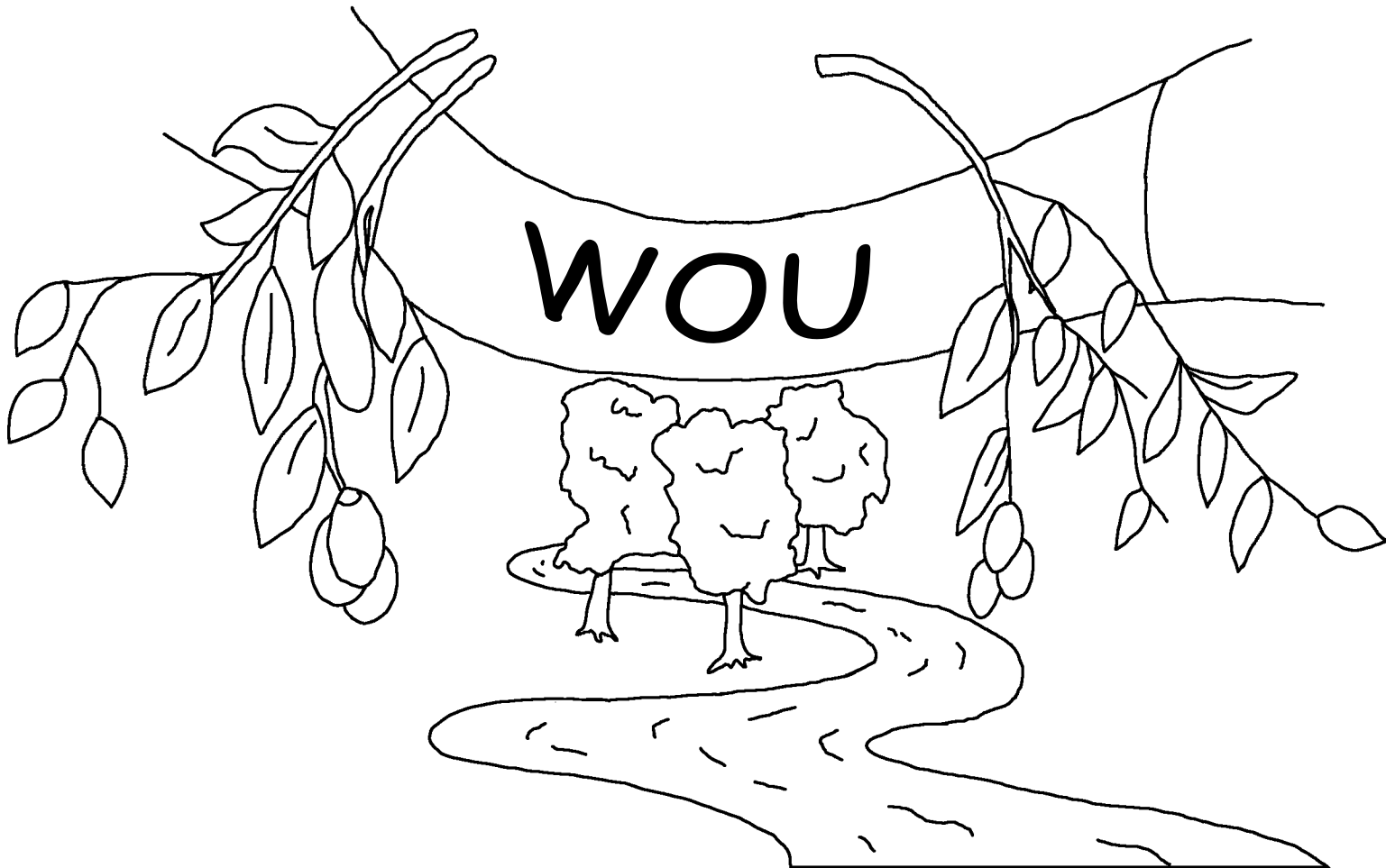

Shumata, Engaji Sidai E nkai

Ororei lenkai, biblia

Lotumoi tiatwa

Yohana 14; 2 Iikorinto liare 5;
Embulunoto 4, 21, 22

"Ejing'ata ororei lino neeu eong'an."
Orkerembe 119:130



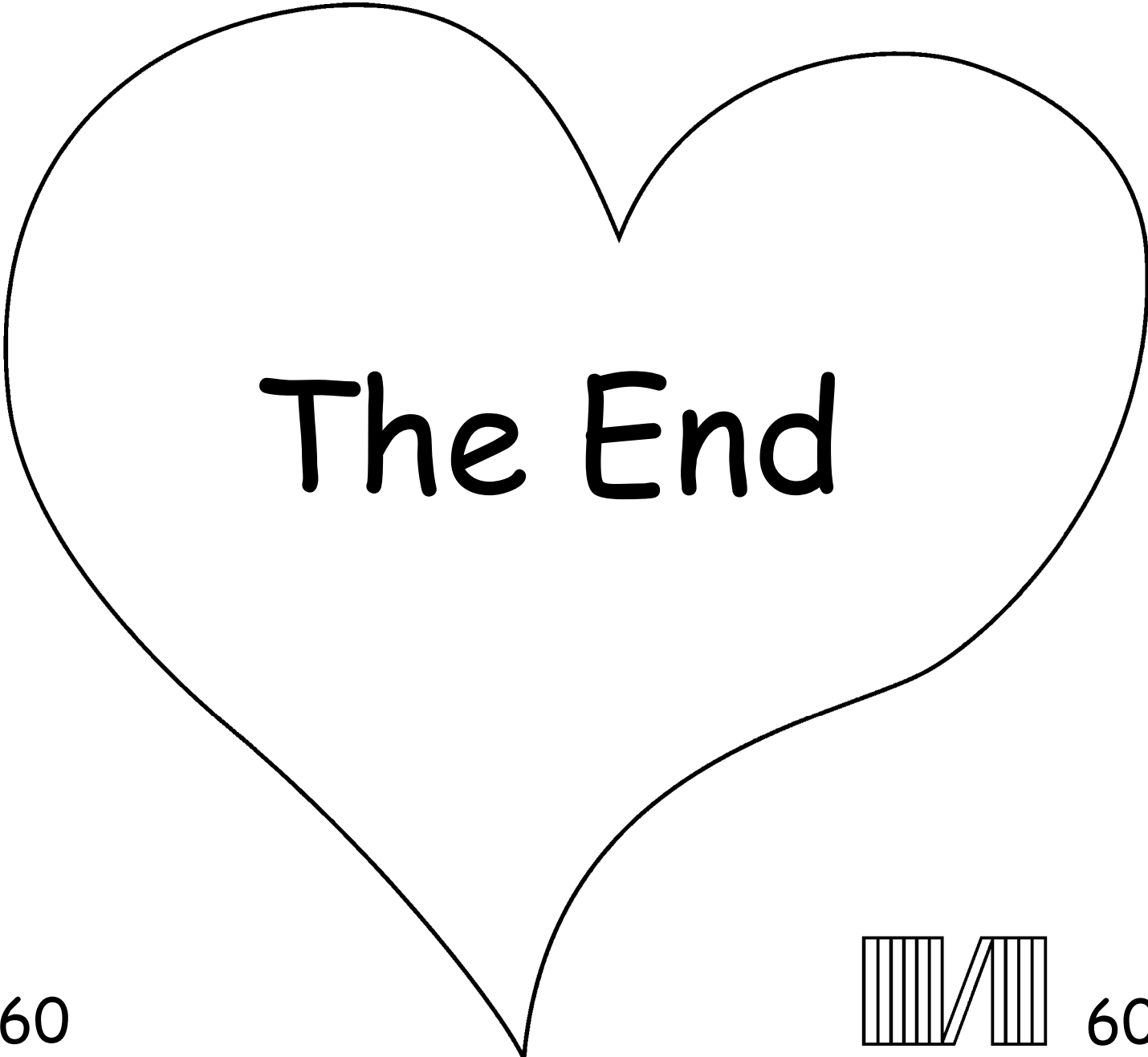

The End



Iho kuloomon le biblia eliki iyoo enging'asyta
naata enkai, naitobirwa iyoo neyeu inye enkai piyeleu inye.

Eyelo enkai aajo kitaasa imbaak torok e ng'oki. Neekiho
entoki naau eng'oki nee engeeya, kake enyor naleng' iyook
enkai, o miriu enkerai enye Yesu peelotu aiminye enkishui
enye to solaba peelaku iyook tiatwa ing'ok. Nepoku Yesu
neshuko shumata. Iho taata eidim enkai
aatapaliki iyook ing'ok nikiata.

Tenirukito aajo esipa kulo oomon, tusuja ele rorei aajo!
YESU lai lotii shumata, airuk aajo aira enkai, niaku oltung'ani
piminye enkishui ino torbaye loo ing'ok ainei, nipoku tengeeya
nitum enkishui katarei. Aomonu pijing aatwa enkishui ai
nikipaliki ing'ok ainei, paatum enkishui ng'ejuk, iho
tengolong' nabo naton tengaji ino intarasi. Taretokoki
paaton tengaji ino tanaa enkerai ino.

Isoma biblia nirorie enkai ingolong' pookin! Yohana 3:16

