

Biblia o Nkera Neu

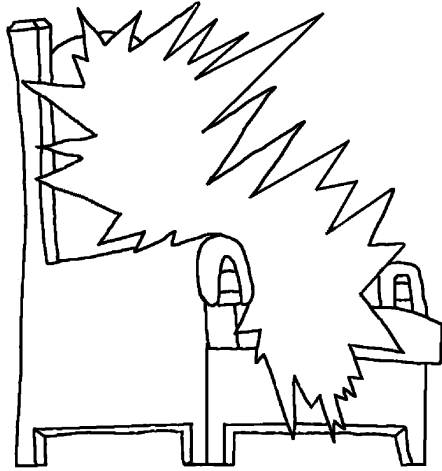

Shumata, Engaji Sidai E Nkai



Written by: Edward Hughes

Illustrated by: Lazarus
Alastair Paterson

Adapted by: Sarah S.

Produced by: Bible for Children
www.M1914.org

©2024 Bible for Children, Inc.

License: You have the right to copy or print this story,
as long as you do not sell it.

Iho opa etonita yesu tenakop Negira aaliki
Iwanafunzi lenyena imbaak eshumata neekipoto
aajo "engang'e papa" nejo ore
shumata netii intonat sidan
Naleng'. Iho shumata
Niikitok nelala
aalang'Ingajiji
kituak tenakop.



Nejo YESU "aloito nanu aitaboraki intai ewaji tenashumata, kake ashukunye paalotu aarikintai engaji ai". E homo opa Yesu shumata etopokwa te ngeeya Iho ing'urita iwanafunzi lenyena nedumu ni YESU ailepye, neep inkatambo peemedoli katareg.

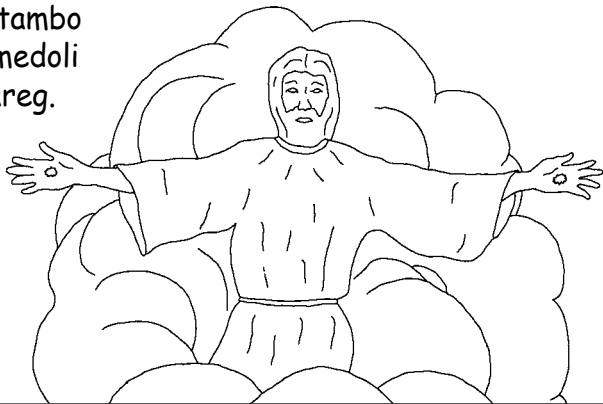

3

Aitertina neeku edamu likirisiano aajo etojo opa YESU eshukunye aaya intai. Etejo opa YESU eshukunye, tengata nemeji inye eshukunye kake oo irikirisiano loiminie engishui eton itwelotu YESU? Ejo biblia ekewo aaboita oo YESU. Aamu tenemoti I osesen na YESU ibotaire.

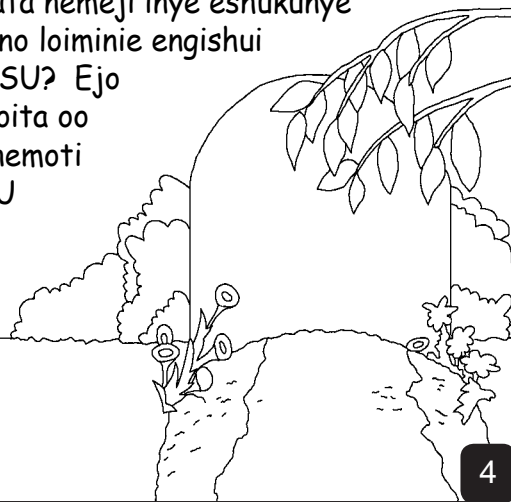

4

Embolunoto engitabu ee kurum te biblia neliki iyook enging'asya e shumata. Nabo ne nging'asya na engoitoi sidai iho engay na iho shumata na engaji o engai. Na ekitii engai ewoji pookini tenakop kake iho engaji enye na shumata.

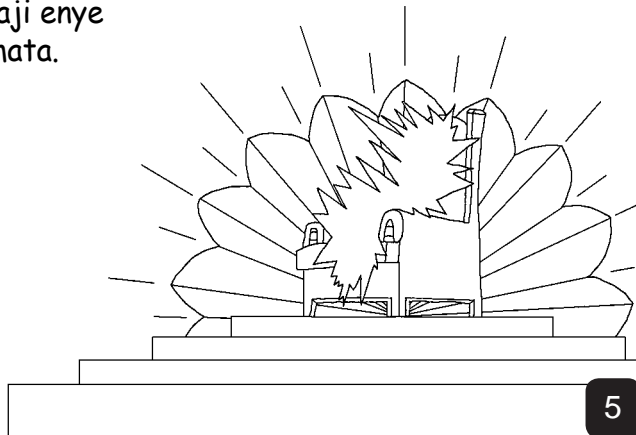

5

Iho irmalaikani oo ngulien engishui te shumata neekesaita engai. Ore ake iltung'ana lengai loo twata newoshumata neseremita sininje aarany isingolaiti lengito o enkai.

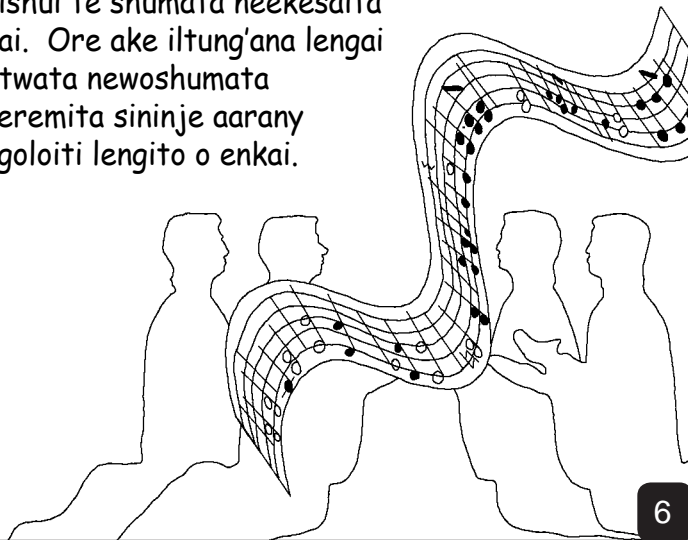

6

Iho kule na isirat lo singulio loranyiteshumata "KUNCHIIKINO INVIE PEEIDUMU OLPIYAYATI LEEMBUKU NIBELILMSHIREN AMU KITEYENG'AKI APA NAA TO SARGE LINO INYIANG'AKA ENKAI ILTUNG'ANA AITUNG'AA LOSHON POOKI O ING'EJEP, O ILTUNG'ANA O LERERE (Embolutono 5:9).



7

Iho isirat lekurum te biblia negira aalimu shumata tanaa "jerusalem ng'eju". Kitok naleng' neeta oikuta leboo o liatwa loitoibiritukul to masaa naibilbil. Iho irmulangoni neitobirakwi te lulu sa puk nalong.

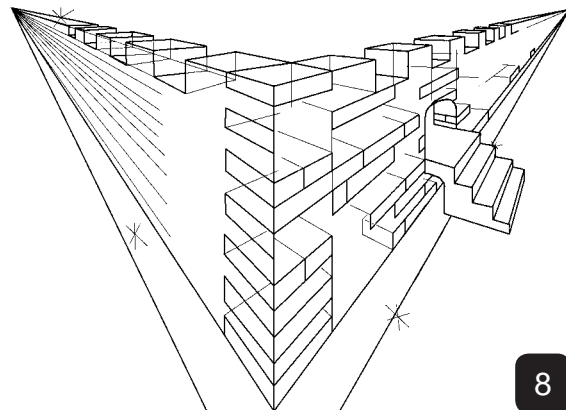

8

Iyelo irmulangoni loitobirwaki te lulunee kebolo tengata pookin matijing aatwa peekidol abarakin ... WAAA iho shumata neekiliiy anag'ainye aataaji. Iyelo inakop na enkop sidai e sahabu baiki ing'oitoo ine sahabu ake sininje.

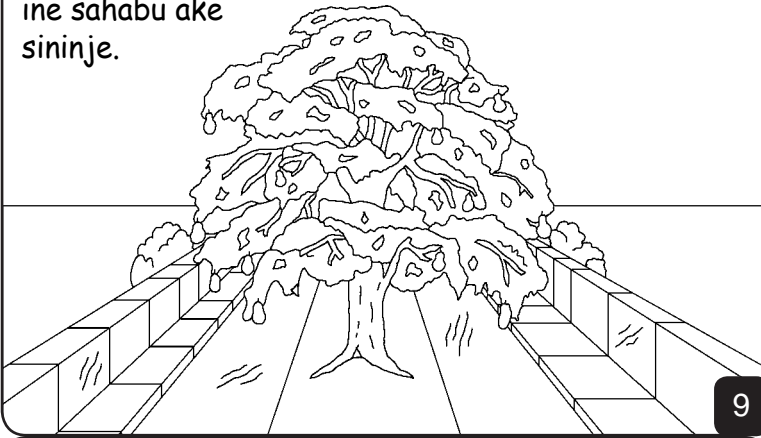

9

Eketii irkeje sidan le ngare engishui looruko niliil loopuku to lorika lengitoo enkai. Iho toobat orkeje netii irchanito sidan lengishui lootii opa aatwa eden. Iho elehani naa obo ake neitau irmatunda loomwan torono aare te kila olapa. Neekihor imbala eilohuni neishiunye ileshori.

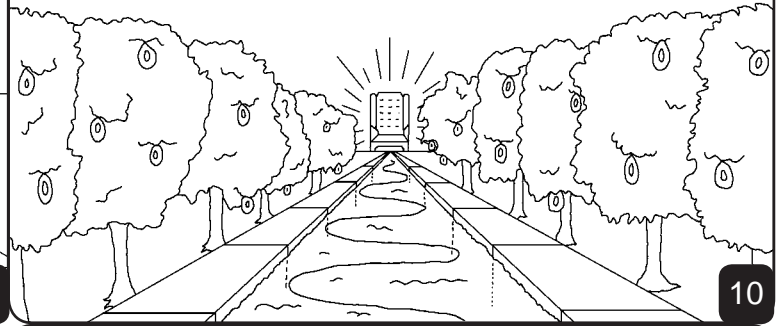

10

Iho shumata meyu engolong' pe olapa enkitoo enkai naitai eong'an sapuk naleng' Nemetii engewarie tukul.

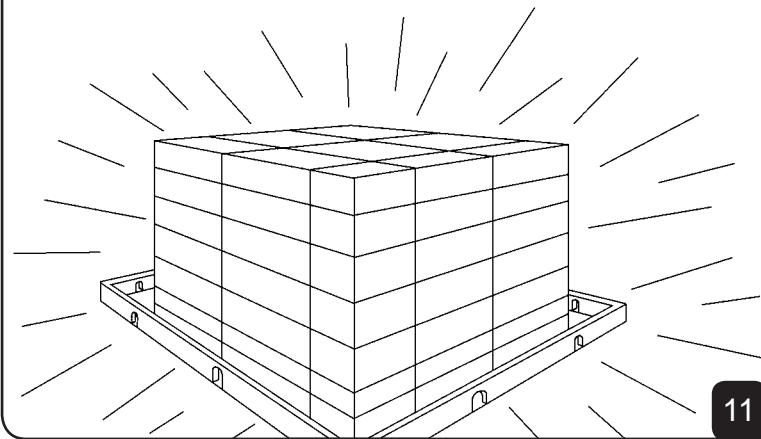

11

Iho ilowarak pookin te shumata na ilomwai kumok. Na aisupati pookin ildyain onera nekeda pookin. Baiki orng'atuny neekadaa ongishu. Ekejo enkai "metum enyamali ne meimin tiatwa oldonyo lai sidai".

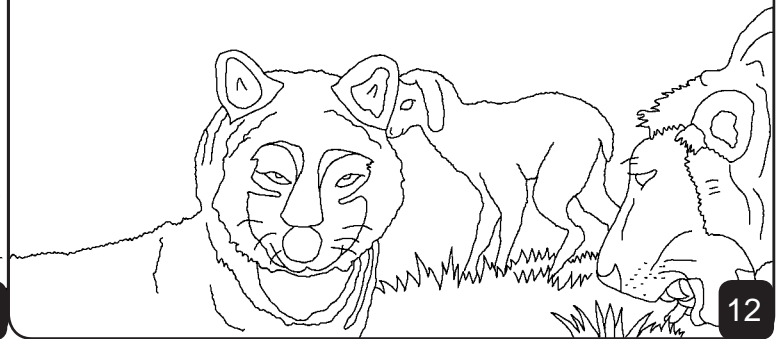

12

Iho kigira aing'uraa nikiyeleu aajo etii intokiti nemotii shumata. Metii ilomon legoro metii iltung'ana loora au loomit. Meikenii oweii teshumata aamu metii ilaporuk. Metii ilalaja, metii ilagoro, metii ilasakuto. Metii eng'oki shumata.



13

Metii engilio shumata iyolo ohi eihir iltung'ana lenkai terbaaye lo sina sapuk le ngishui tenakop. Ekijit iyook enkai irkiyoo te shumata.



14

Metii engeeya shumata eketeni iltung'ana lenkai intarasi. Meeku etii osina o emion meeku etii imoyaritin o enkipung'ot tukul eketon oltung'ani tenchipay o enkai.



15

Penareu duo tukul iho shumata eno ndoyok or layok (o iltung'ana kituak) lootang'amatwa YESU peepik enganyit tanaa enkai enye. Etii shumata embuku naji "Embuku engishui" enabore ingarin oltung'ana kamaa iyelo aajo ingarin oltung'ana kamaa, iyelo aajo ingarin oakwa tung'ana loosira?

Iltung'ana lootipika osiligi lenye aatwa YESU ketii engarna ino?

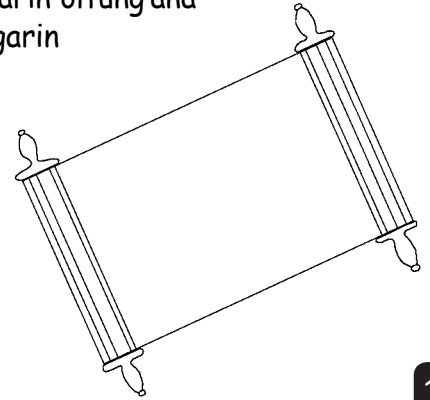

16

Iho isirat lokurum te biblia neeta ukaribisha. "Ejo oltau wou" Iho oloota engure nolotu peetum engare enkishui pono.



17

Shumata, Engaji Sidai E nkai

Ororei lenkai, biblia

Lotumoi tiatwa

Yohana 14; 2 Iikorinto liare 5; Embulunoto 4, 21, 22

"Ejing'ata ororei lino neeu eong'an."
Orkerembe 119:130

18

The End

60

60

19

Iho kuloomon le biblia eliki iyoo enging'asyta naata enkai, naitobirwa iyoo neyeu inye enkai piyeleu inye.

Eyelo enkai aajo kitaasa imbaak torok e ng'oki. Neekiho entoki naau eng'oki nee engeeya, kake enyor naleng' iyook enkai, o miriu enkerai enye Yesu peelotu aiminye enkishui enye to solaba peelaku iyook tiatwa ing'ok. Nepoku Yesu neshuko shumata. Iho taata eidim enkai aatapaliki iyook ing'ok nikiata.

Tenirukito aajo esipa kulo oomon, tusuja ele rorei aajo! YESU lai lotii shumata, airuk aajo aira enkai, niaku oltung'ani piminye enkishui ino torbaye loo ing'ok ainei, nipoku tengeeya nitum enkishui katarei. Aomonu pijing aatwa enkishui ai nikipaliki ing'ok ainei, paatum enkishui ng'ejuk, iho tengolong' nabo naton tengaji ino intarasi. Taretokoki paaton tengaji ino tanaa enkerai ino.

Isoma biblia nirorie enkai ingolong' pookin! Yohana 3:16

20