

Alketab ka angguy nak - kanak
ka angguy

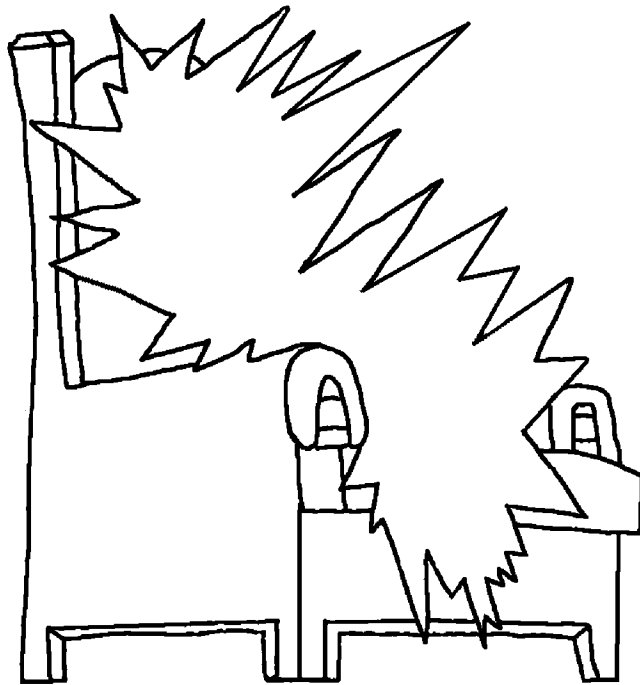

Sowarga
Kennengngan
Guste Allah



Etos bi': Edward Hughes
E elustrasi agi bi': Lazarus; Alastair P.
E potdhut bi': Sarah S.
E terjemah agi bi': Anik Kongariawati
E gabay bi': Bible for Children
www.M1914.org

BFC
PO Box 3
Winnipeg, MB R3C 2G1
Canada

©2021 Bible for Children, Inc.
Ba'na bisa pa - banyak otaba anyitah careta', se abit tah juelah.



Bile Yesus gi'badha e bume ret-moredda e beri tao kennengngan e nyama sowarga. Yesus asebut "Bungkona Rama," ban ngoca a dhiya'banya' ko-bingko. Bungko se raja ba bagus. Sowarga se raja ban bagus dhari kabi' ko-bungko e bume.



Yesus adhabu "Sengko dha'essa'a nyadhiya'agi kennengngan ba'na." Yesus la entar ka sowarga, Saellan Yesus abungo dhari' maot. Ret-moredda gi' terros ngabas ka langnge', Yesus epaongga ka langnge', ban katapoan ondhem sampe'ta' etangale'e pole.

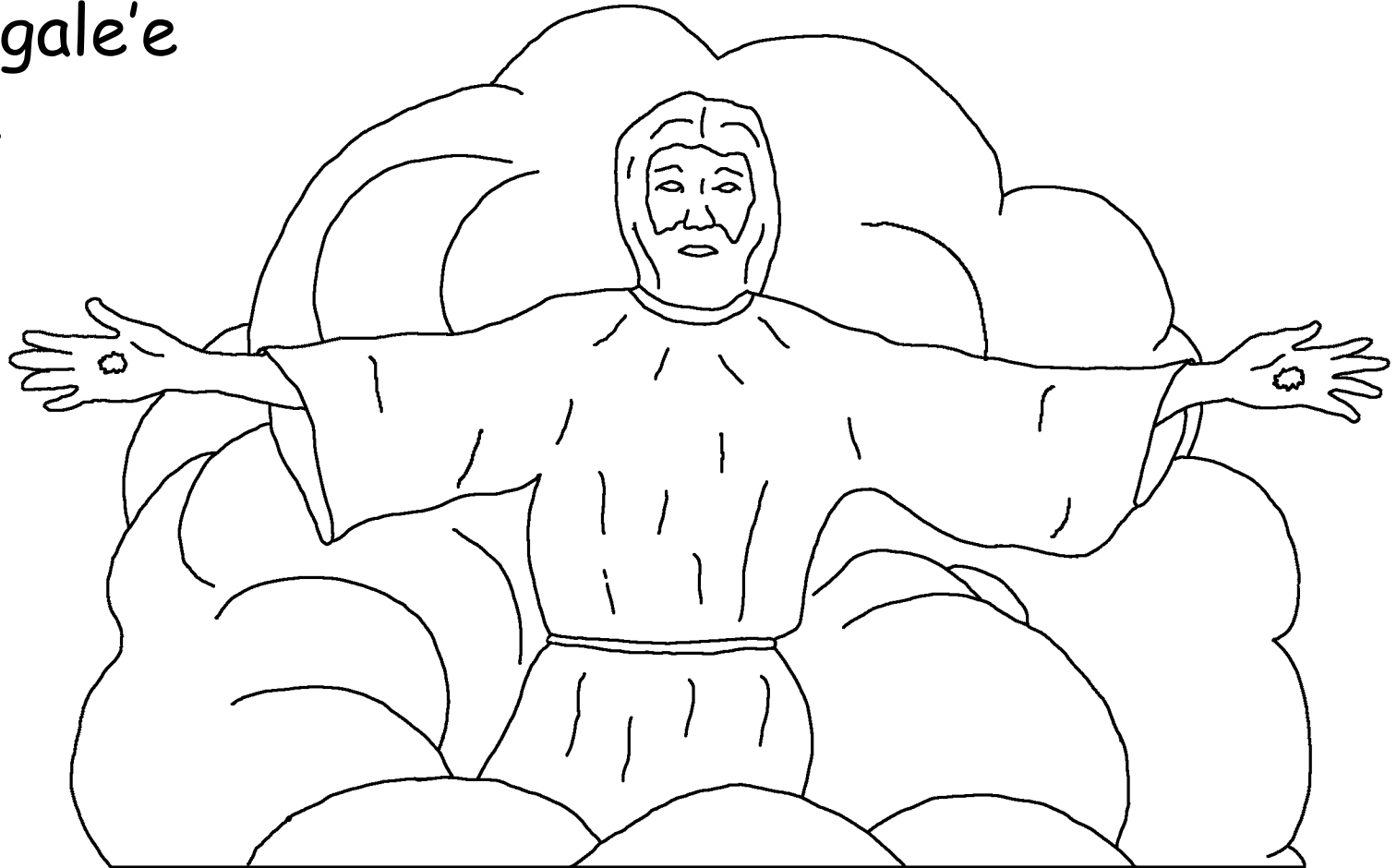

Saellana, reng-oreng kresten pa'inga' janji Yesus bakalan abali ka dhibi'na. Yesus adhabu, Sengko' paste abali ba-tiba. Tape dhe'remma ban

reng-oreng kresten se mateya sabellunna Yesus dhateng?

Alketab nyaretaagi, sakabbina la entar abarang Yesus.

Entarra dhari badha se arte reng-oreng

ban Gusti Allah.

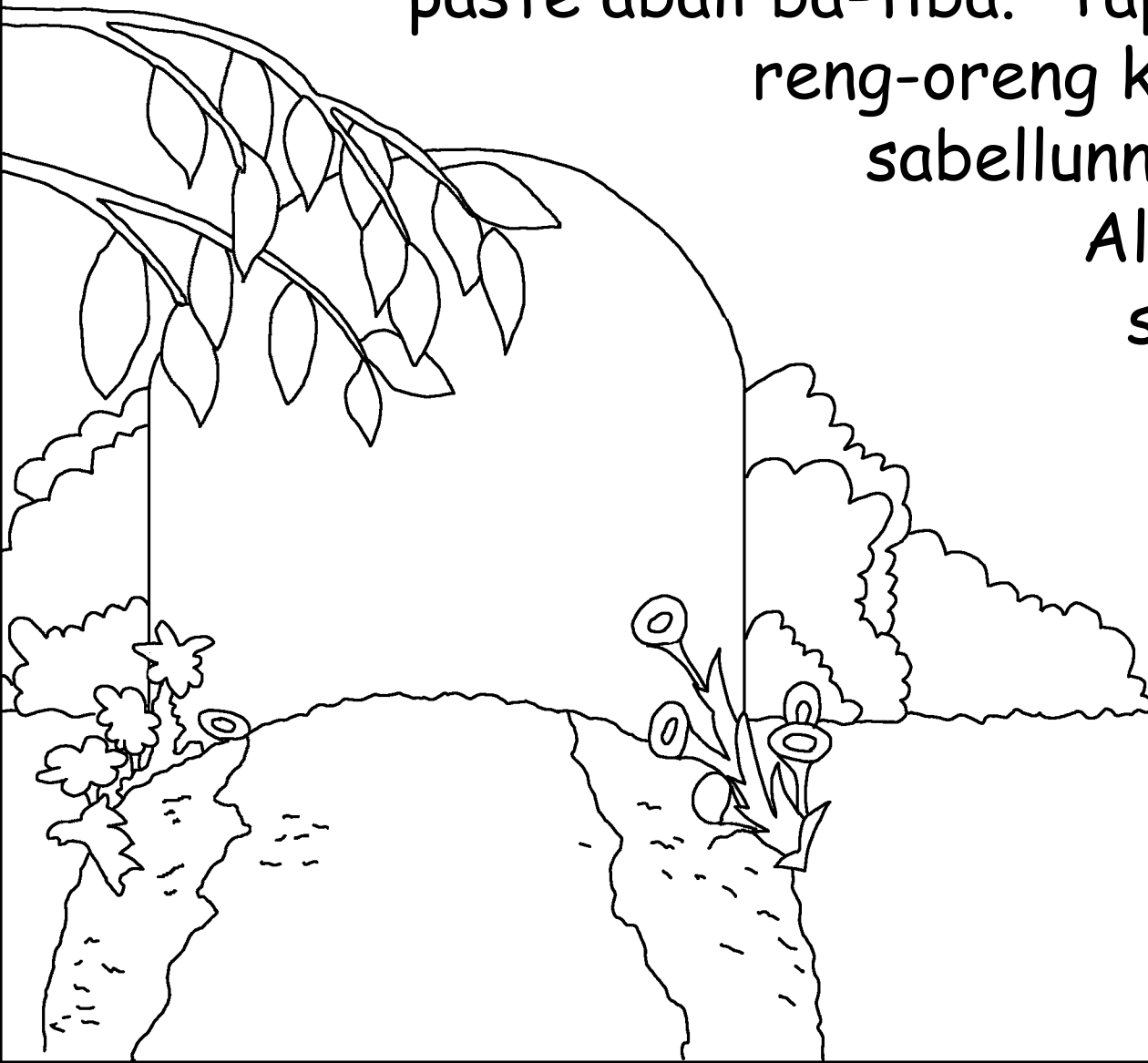

Wahyu, Alkitab se palleng akher, e beri tao
bagussa dhina sowarga. Hal se palleng bagus
jareya sowarga kennengnganna Guste
Allah. Guste Allah badha
ema-demma, tape
kennengnganna
e sowarga.

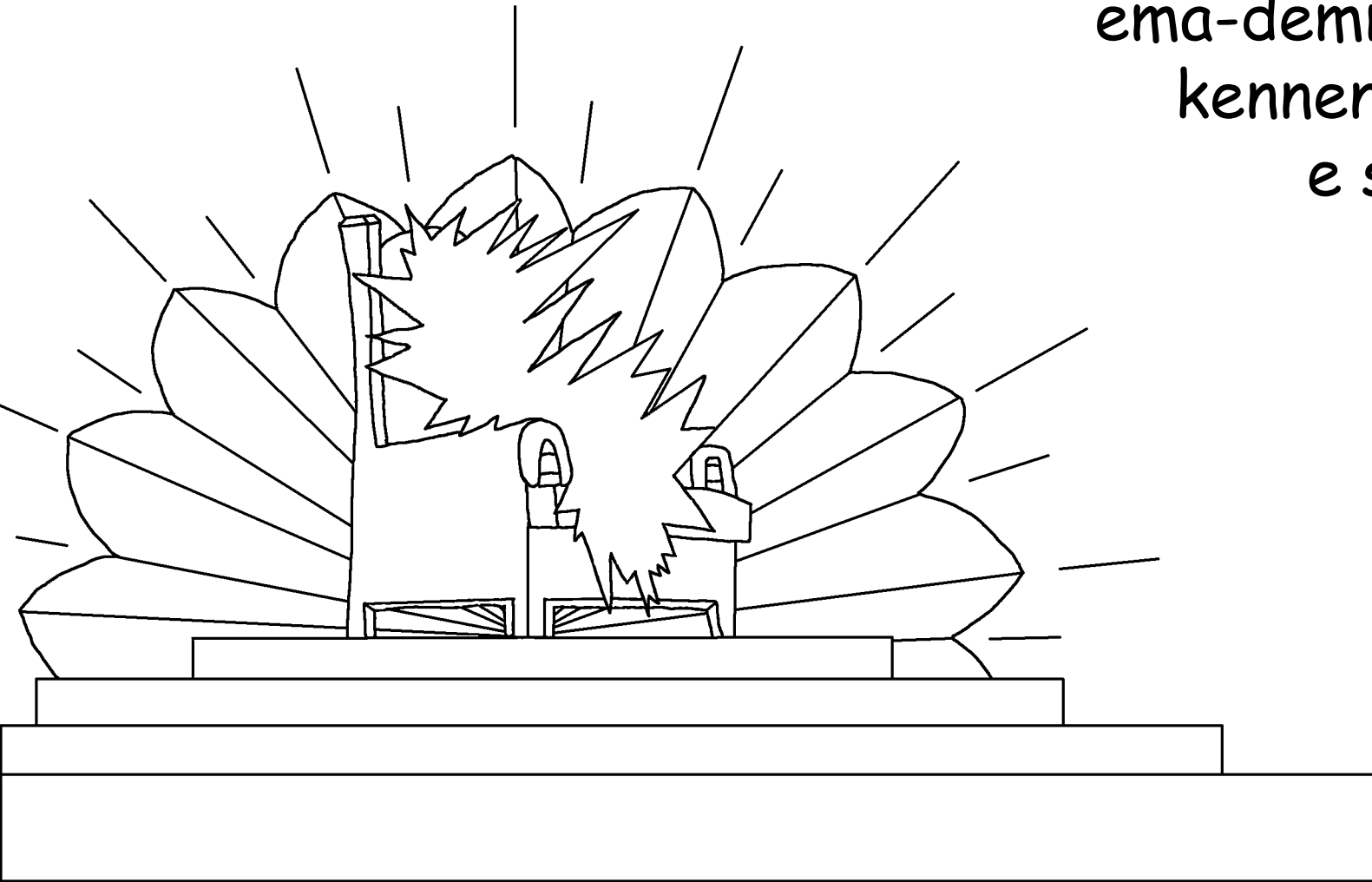

Para malaekat ban lok-mahlok sowargi
laenna asujjudde ka *Guste Allah*.
Ban reng-oreng pertaje se la
mate ban entar ka sowarga.
Kadhibi'na anyanyiagi
bang-tembang
ngamolyaagi
Guste Allah.

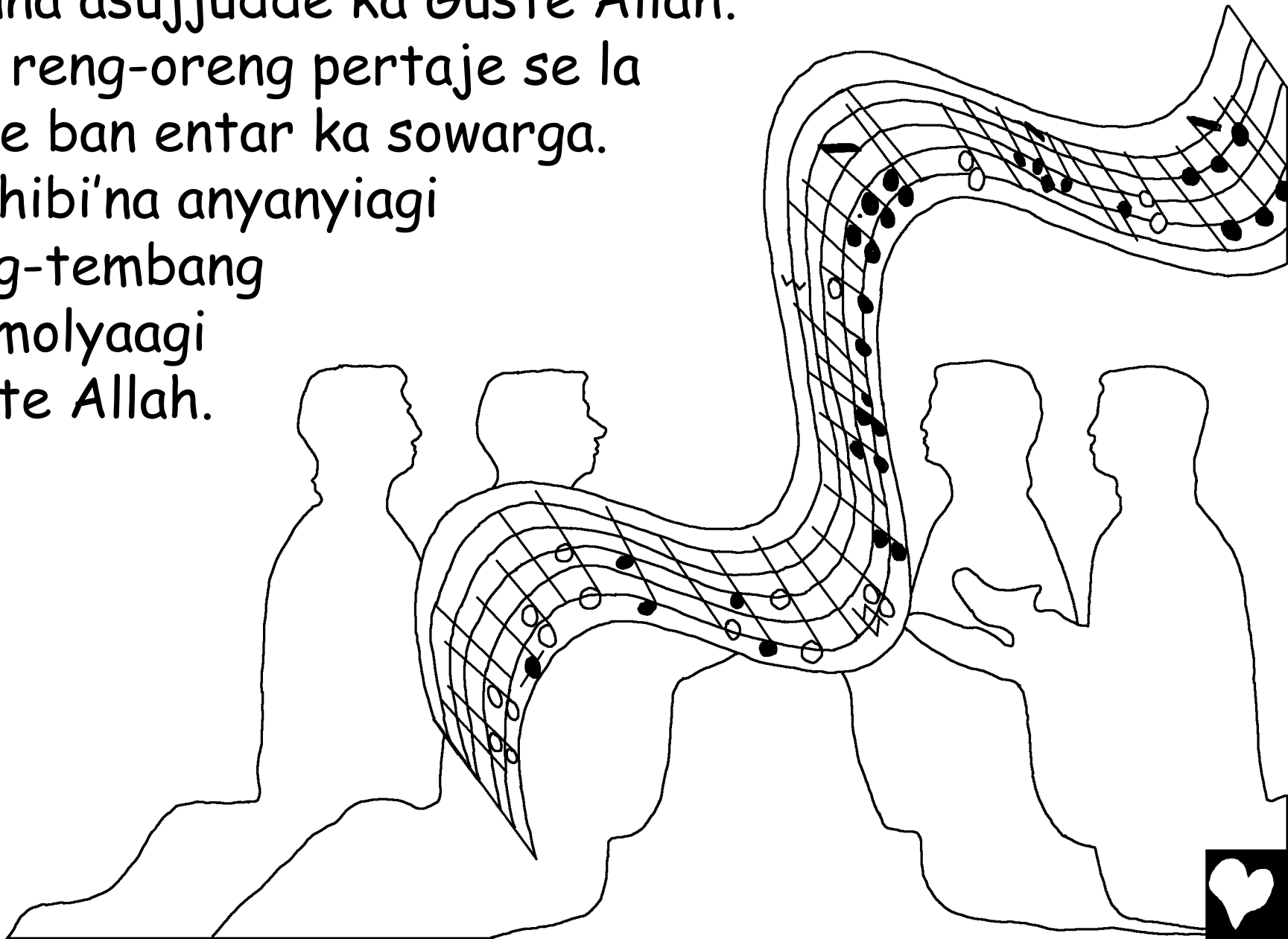

Jareya bang-tembang se e nyanyiagi.

"JUNANDALEM PATOT SABAB

JUNANDALEM LA E TEBUSSA

ABDI KA ALLAH BAN

DARRANA JUNANDALEM

DHARI' KU-SUKU BAN

SA-BANGSA BAN

E GABEYA

ABDI

TO-RATO

BAN

MAM-IMAM

KA ALLH

ABDI".

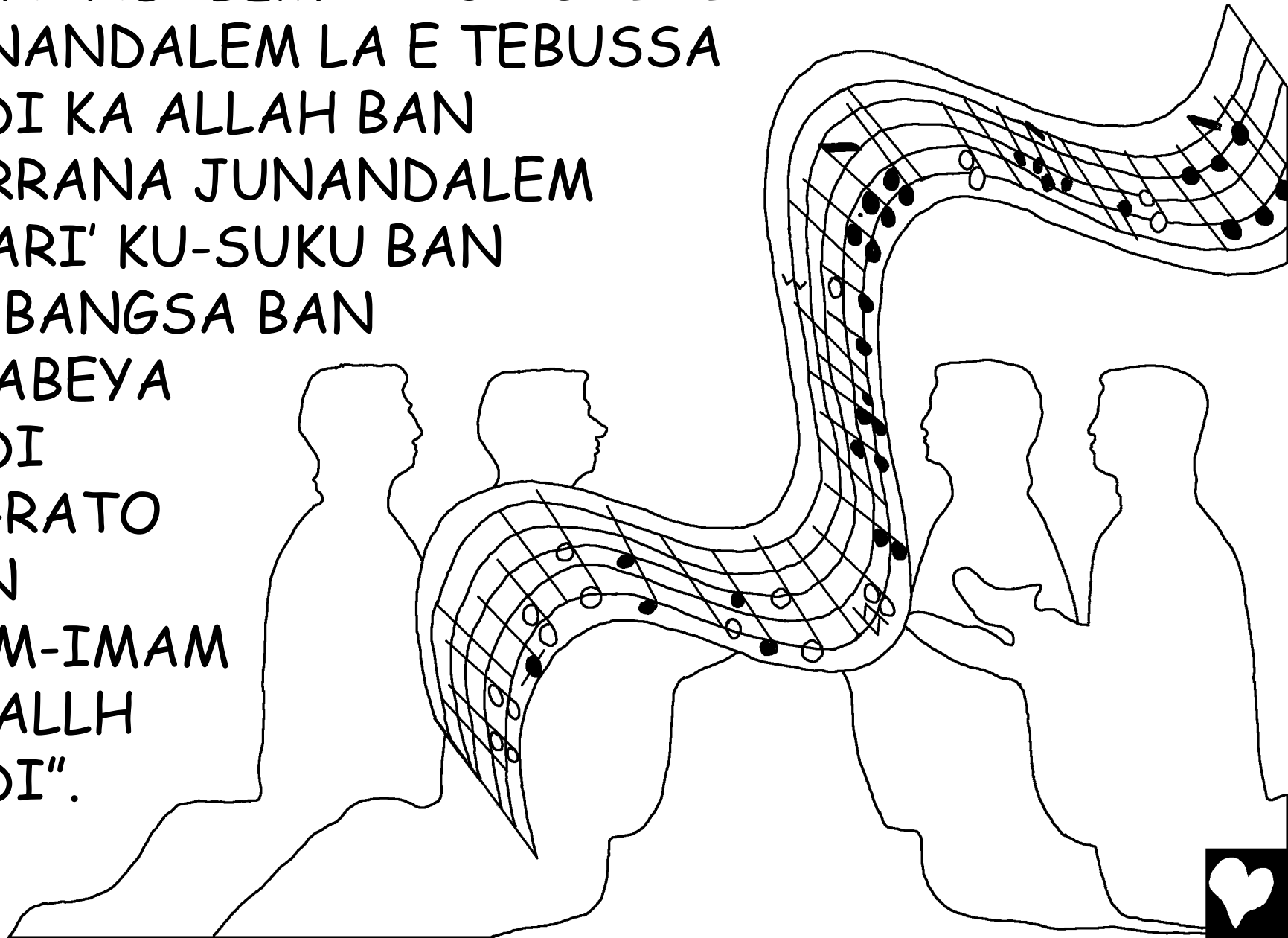

Se akher dhari Alketab agambarragi sowarga jareya
"Yerusalem Anyar." Jereya ban geddunga tenggi' e
loar. E geddung ganeka dhari bato yaspis, se bening
akadi kaca. To-batoan se bagus notoppi geddung
jariye, sonarra se bagus.

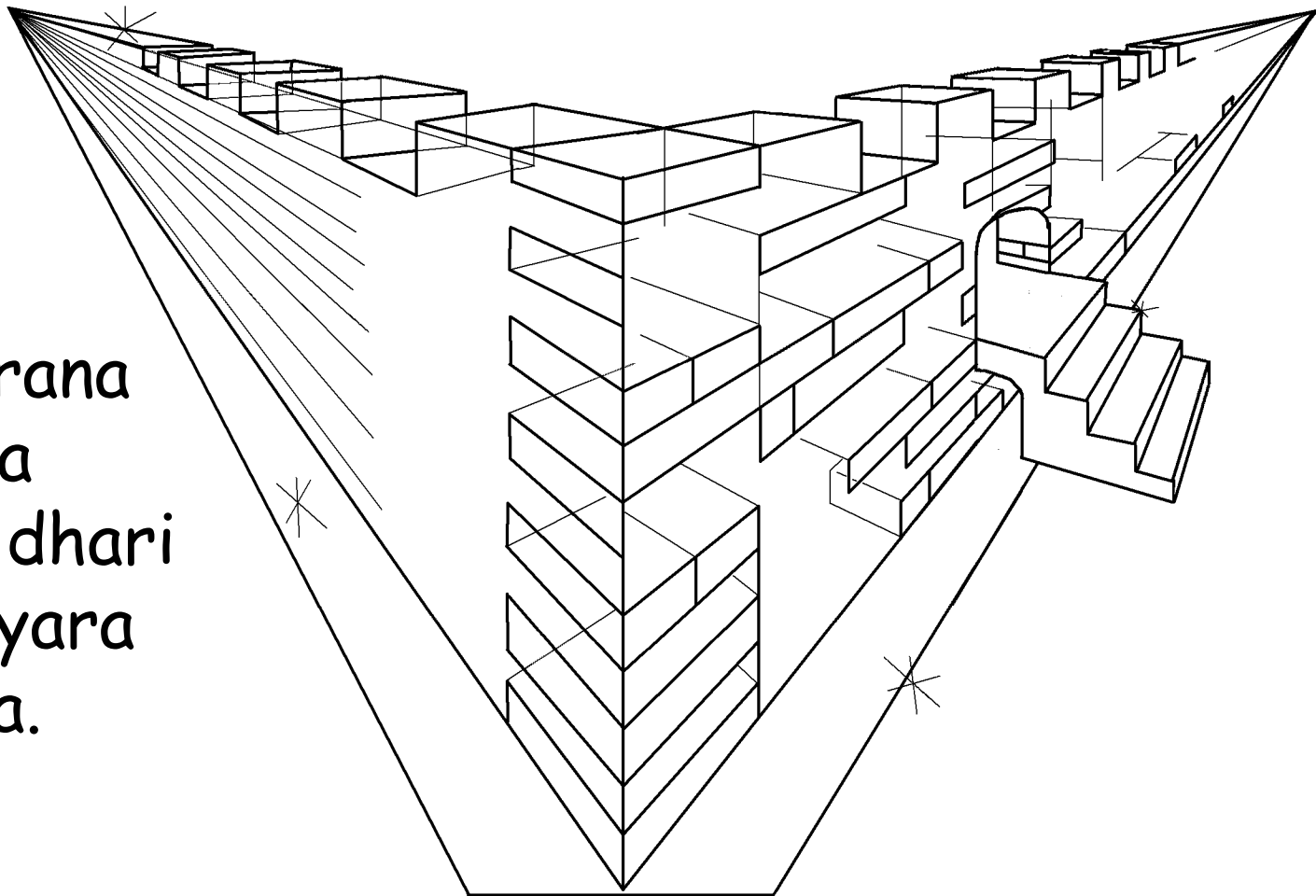

Gapurrana
kotto a
gabay dhari
motteyara
se raja.



Bang-labang motteyara se raja bakal ta'etotoba.
Mara'masok ban nangale e kalilingna...wow! Sowarga
ce'bagussa e dhalemma. Kottana egabay dhari
emmas benneng akadi kaca. Lan-jalanna agabay
dhari emmas
morne.

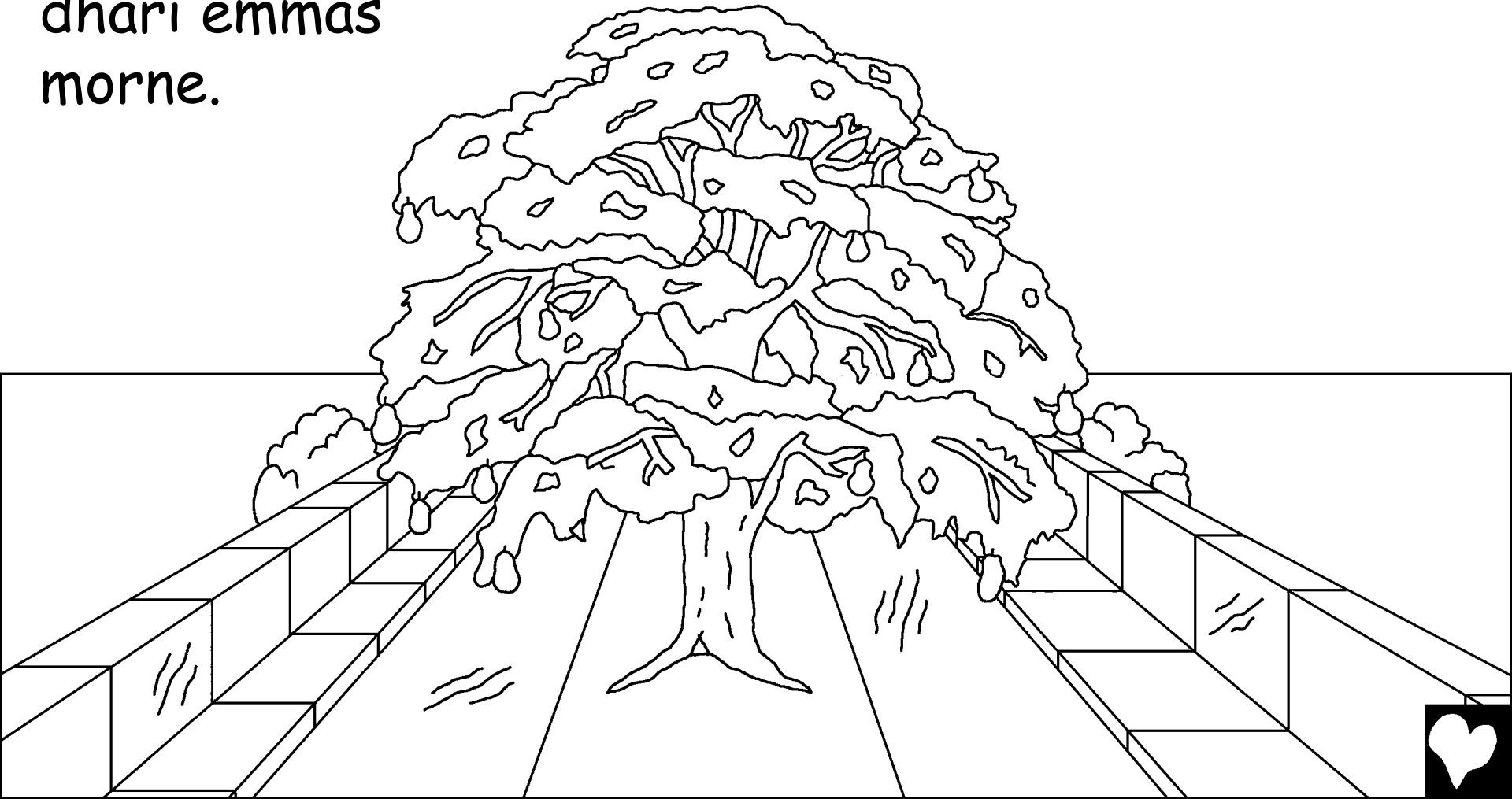

Songay ganeka arap-galirap akadi kresten ban agili dhari tahtana Guste Allah. E penggir songay ganeka badha bungkana sumber kaodhi'an, se kapeng settong e patemmo dhi' bun-kebunan Eden. Bungkana jareya aistemewa. Se a buwa dhubellas wah-buwaan, se ta'padha e bulanna. Ban dhaunna egabay ka angguy mabarar sa-bangsa.



Sowarga ta' parlo sonarra are otabe bulan,
kaagunganna *Guste Allah* dhibi' bakal
nera'ana, ban tadha' malem pole.



Ban-keban e sowarga laen ta'padha e bume.
Sakabbina jinak ban akor. Sarigala ban dhumba
ngakan jokut reng-bareng. Singa se koat ngakana
padhe bi' rossa. Guste Allah adhabu, "Sakabbina
ta'a rosak gunung soccena Sengko."



Bile e congo' ka kalilingna badha se tadhe', ne e
sowarga ta'dhe' ca'oca' se jube'. Ta'dhe' oreng se
e carokotaba alako jube'. Ta'dhe' to-pentto se e

konce, sabab
sowarga.
mongker,
oreng,
oreng se
angguy
mo-elmo
gaib, otaba
orang se
jube' laenna.
Ta'dhe' dusa
pa-napa e sowaarga.

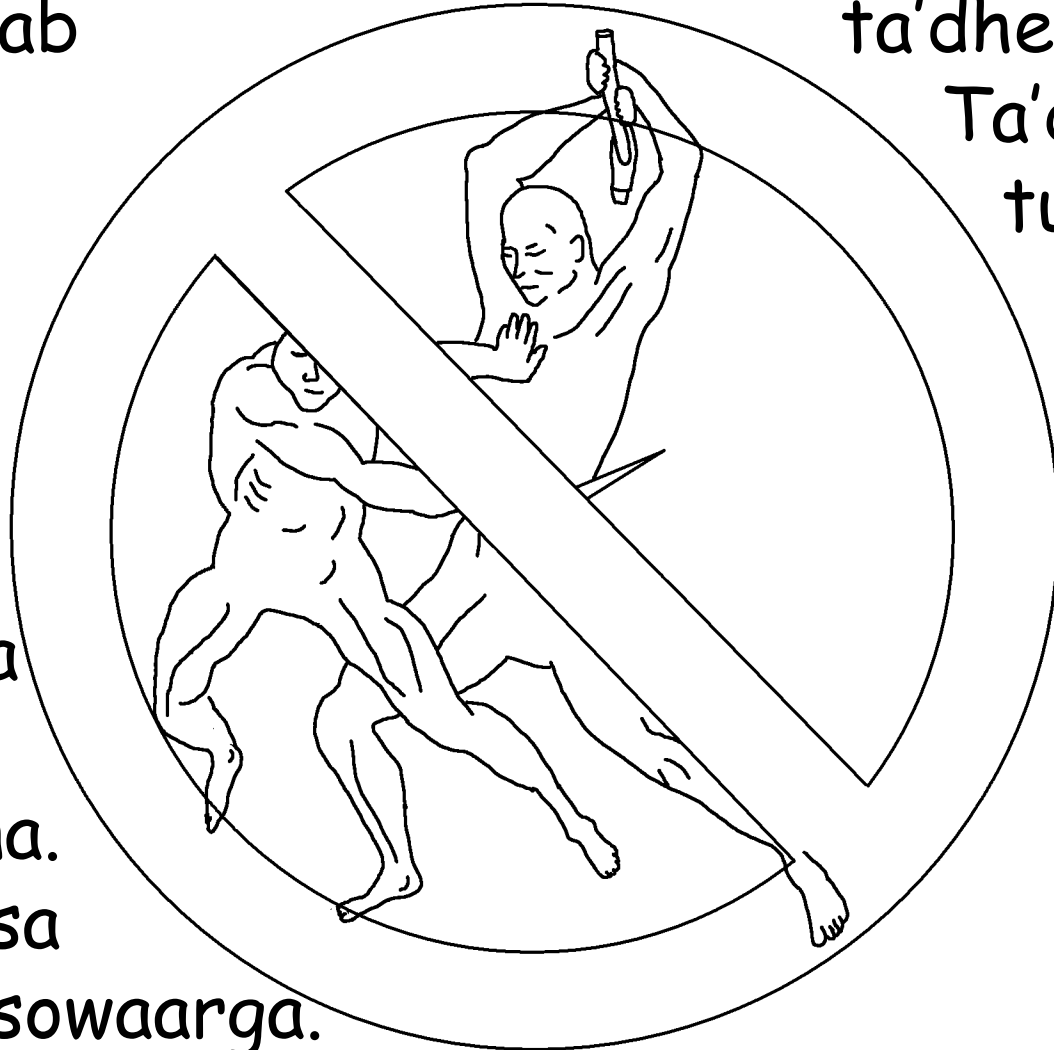

ta'dhe' se ngala'a e
Ta'dhe' se
tukang mate'e



E sowarga bi' Guste
Allah ngosaba aeng
mata, bile reng-oreng
se partaje nanges
sabab kasossa'an se
raja e kaodhiennana.
E sowarga Guste
Allah bakal ngosaba
aeng mat.



Ta'dhe' se mate e sowarga. Reng-oreng se iman
apolonga ban Guste Allah. Ta'dhe' dhei kasossaan,
ta'dhe' dhei tangesan, ta'dhe' dhei se sake', ta'dhe'
ke'-penyake' ban ta'dhe'
se e ngoburragi,
kabi' oreng e
sowarga bajjra
ban Guste Allah
salanjangnga.



Se becce dhari sakabbina, sowarga kenengngan gabay lalake' ban babine se partaje ka Yesus Kristus Jurusalamatna ban norotti Dhibi'na se dhadi gustena. E sowarga badha buku se e nyama buku kaodhi'an. Buku keya ma-nyama orang. Apa ba'na tao sapa se e toles jareya? Kabi' orang se imanna ka Yesus. Apa nyamana ba'na badha e dhisa'?

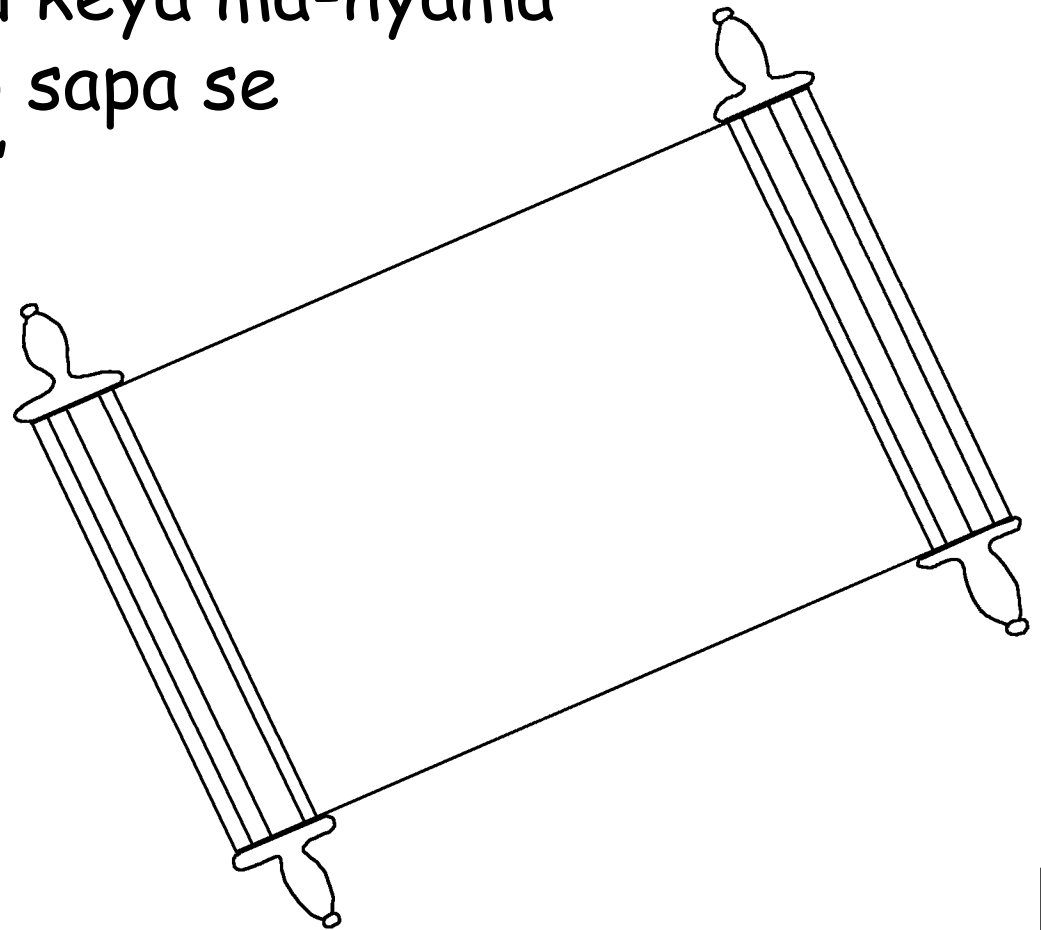

Ca'oca se akher Alketab, sowarga jareya ondangan se bagus. "Ban Erroh socce ban panganten babine ngoca', Mara'sapa se engeding, ban ca'ngoca', mara ban sapa se pelka', mare datheng. Ban sapa se endhe', mare ngala' aeng kaodhi'an se e ma-coma."



Sowarga Kennengngan Guste Allah

Alketab jareya nyareta agi firmanna
Guste Allah

se e bedhe' e

Yahya 14, 2 Korintus 5,
Wahyu 4, 21, 22

"Masuk ka firmanna Guste Allah e beri tera'."
Bangsalam 119:130



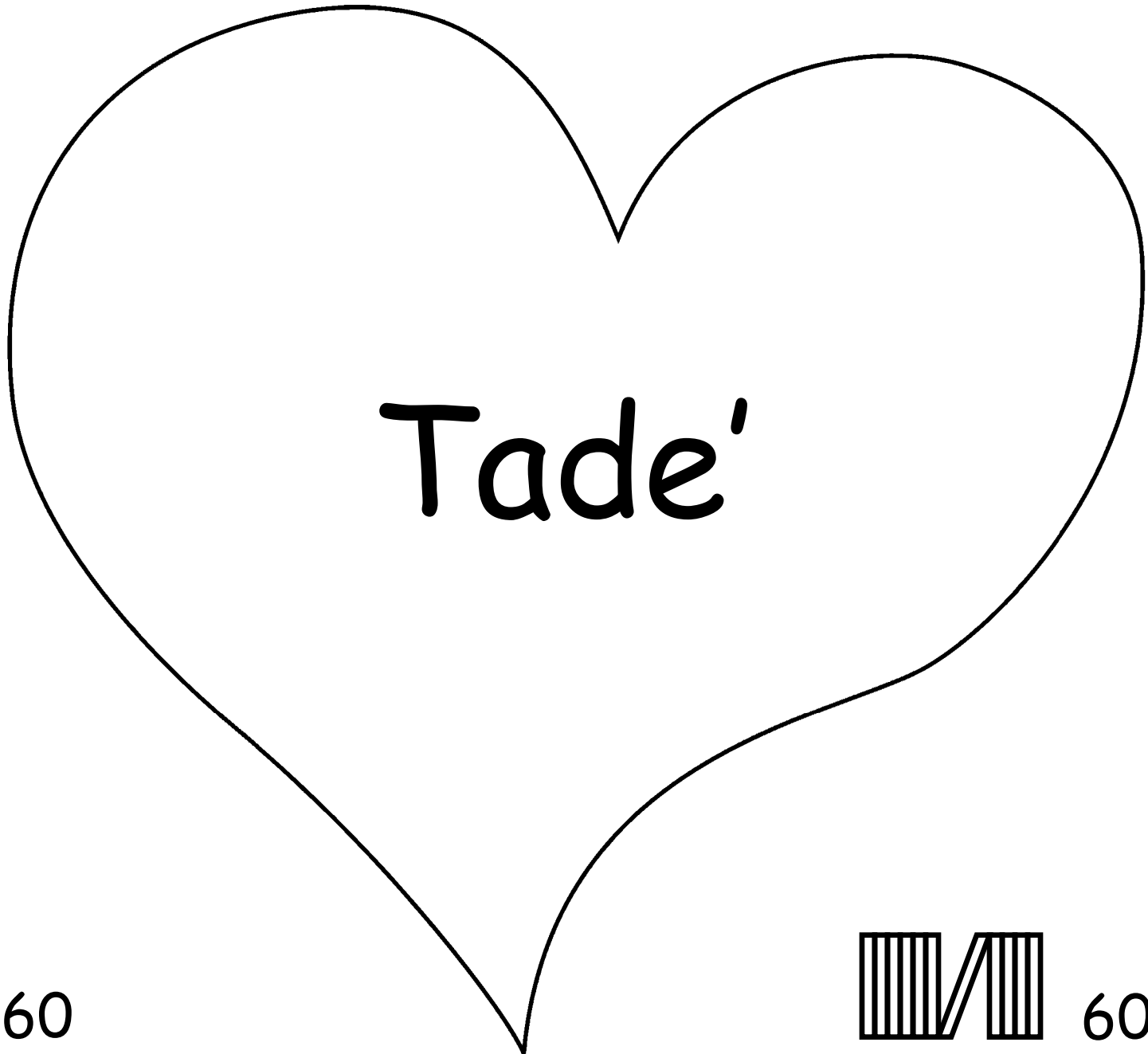

Tade'

60

60



Careta Alketab notorrangi Guste Allah paneka se becce se nyepta' agi manossa sopaja ba'na kenal ka salerana.

Guste Allah tao manossa ngaloko'agi se jube', se e sebut dusa. aokoman dusa jareya e patte'e, tape kataresna'anna Guste Allah ka manossa setalebat raja ban apereng Pottrana se coma settong, Yesus, se mate ekaju salib ban aokom kaangguy dusana ba'na. laju. Yesus a bungo ban abali ka sowarga! bile ba'na partaje ka Yesus ban apenta saleranan ngamponi dusana ba'na salerana angalako agi. Salerana rabu ban odhi ban ba'na sateya, ba'na odhi sareng salerana salanjangnga.

Bile ba'na partaje, ngadoa ka Guste Allah cara jareya: duh Guste Allah, abdi partaje ka Guste Allah, se daddi manossa laju seda sabab dusana abdi, ban Salerana odhi pole. mara datheng ka odhi na abdi ban angapora dusana abdi, sopaje abdi odhi anyar, ban e are gu'laggu abdi olleh odhi ban Salerana. abanto abdi noro'lampadda padana Salerana ban odhi na abdi daddi potrana Gustte Allah.

Ngabaca Alketab ban ngadoa ka Guste Allah ban are. Yahya 3:16

